

# **Fact or Fiction: the problem of bias in Government Statistical Service estimates of patient waiting times**

Paul Walter Armstrong

London School of Hygiene & Tropical Medicine

Thesis submitted for the degree of Doctor of Philosophy of the Faculty of Medicine,  
University of London

January 2000

© *The copyright of this thesis rests with the author and no quotation from it or information derived from it may be published without the prior written consent of the author.*

## Abstract

The cumulative likelihood of admission estimated for any given 'time-since-enrolment' depends on how we define membership of the population 'at-risk' and on how we handle right and left censored waiting times. As a result, published statistics will be biased because they assume that the waiting list is both stationary and closed and exclude all those not yet or never to be admitted.

The cumulative likelihood of admission within three months was estimated using the Government Statistical Service method and compared with estimates which relaxed the assumption of stationarity and reflected variation in the numbers recruited to, and admitted from, the waiting list each quarter. The difference between the two estimates ranged from +5.5 to -9.1 percentage points among 11 Orthopaedic waiting lists in South Thames Region.

In the absence of information on 'times-to-admission', exact 'times-since-enrolment' were extracted from *Hospital Episode Statistics* and assumed to be similarly distributed. In the absence of information on 'times-to-competing-event', the number of competing events falling in each waiting time category was estimated by differencing. A period lifetable was constructed using these approximations, census counts, counts of the number of new recruits and estimates of the number 'reset-to-zero' each quarter. The results support the view that the method used by the Government Statistical Service overestimates the cumulative likelihood of elective admission among those listed.

The Government Statistical Service calculates the cumulative likelihood of admission within three months (range: 0.62-0.27) conditional on the fact of admission. Multiplying by the unconditional likelihood of being admitted (range: 0.93-0.31) estimates the cumulative likelihood of admission within three months among those listed (range: 0.55-0.12) and gives a rather different ranking of waiting list performance among 34 Orthopaedic waiting lists in South Thames Region.

## Contents

	<b>List of tables</b>	<b>7</b>
	<b>List of figures</b>	<b>9</b>
	<b>Preface</b>	<b>10</b>
<b>1.</b>	<b>Introduction</b>	<b>11</b>
	From proposal to PhD	11
	The waiting list ‘population’	12
	Naïve assumptions	13
	Flawless data	15
	Reprehensible practice	16
	Inconsistent misinterpretation	17
	Understanding the data model	18
	Glossary	21
	References	22
<b>2.</b>	<b>Unrepresentative, invalid and misleading: are waiting times for elective admission wrongly calculated?</b>	<b>27</b>
	Summary	27
	Introduction	27
	Setting the scene	
	Clearing the ground	
	Aim	
	Competing events and incomplete observations are omitted	29
	Event-based data captures waiting times incompletely	30
	Non-random exclusions produce unrepresentative results	32
	A proportion, an odds, a ratio or the likelihood of admission?	33
	Conclusion and recommendations	35
	References	35
<b>3.</b>	<b>The rise and fall of the NHS waiting list: how do recruitment and admission affect official estimates of the length of ‘time-to-admission’</b>	<b>39</b>
	Summary	39
	Introduction	39

	Background	
	Objectives	
	Materials & Methods	40
	The stationary population	
	Adjusting for non-stationary recruitment rates	
	Adjusting for non-stationary rates of admission	
	Adjusting for non-stationary recruitment and admission rates	
	Data required	
	Results	46
	Discussion	47
	Limitations	
	Conclusions & Recommendations	
	References	49
<b>4.</b>	<b>Trends in waiting times for elective admission: assertion and counter-assertion in the teeth of the evidence?</b>	<b>63</b>
	Summary	63
	Introduction	64
	Background	
	Objectives	
	Methods	64
	Adjusting for non-stationary conditional likelihoods	
	Data required	
	Results	67
	Discussion	68
	The Government Statistical Service method	
	References	69
<b>5.</b>	<b>First steps in analysing NHS waiting times: avoiding the ‘stationary and closed population’ fallacy</b>	<b>82</b>
	Summary	82
	Introduction	82
	Background	
	Objectives	
	Materials & Methods	83
	The data available	
	The approximations required	



	Four alternative measures?	
Results		86
	The KH06, KH07A and KH07 returns	
	The calendar period lifetable	
Discussion		91
	Are urgent patients given enough priority?	
	How long might I expect to wait for elective admission?	
	<i>Information for Health</i>	
	Concluding remarks	
References		93
<b>6.</b>	<b>Comparing the length of NHS waiting times: can we trust official statistics?</b>	<b>99</b>
Summary		99
Introduction		99
	Background	
	Objectives	
Materials & Methods		100
	Approximate estimates of the cumulative likelihood of elective admission among all those at-risk	
	Published estimates are conditional on ‘having been admitted’	
	The multiplicative rule	
Results		104
	The quality of administrative data	
	The effect on ranked performance	
Discussion		106
	Limitations of approximate lifetable	
	Should we expect a change in ranked performance?	
	Limitations of conditional likelihoods	
	Conclusions & Recommendations	
References		111
<b>7.</b>	<b>Survival analysis and queuing discipline: new light on the synthetic cohort?</b>	<b>127</b>
Summary		127
Introduction		127
	Background	
	Objectives	

Materials & Methods	128
Materials	
The horizontal method: aggregating data on ‘time-since-enrolment’	
The vertical method: aggregation on date of enrolment and on date of interest	
Results	132
Discussion	133
Equivalence: when a survivorship ratio equals the conditional likelihood of survival	
Equivalence: when event times are ranked within the set of ‘times-since-enrolment’	
Conclusions & recommendations	
References	135
<b>8. Concluding remarks</b>	<b>141</b>
John Graunt and Edmund Halley	141
Queuing priority	142
Main contribution of thesis	143
Dissemination of results	145
References	146
Appendices	148

## List of tables

Table 3.1	Count of the numbers recruited to Trauma & Orthopaedic waiting lists in South Thames Region BY quarter enrolled BY hospital
Table 3.2	Count of valid * elective episodes sampled from selected enrolment cohorts - 1 July to 31 December 1994 incl. Trauma & Orthopaedics in South Thames Region BY waiting time category BY hospital
Table 3.3	Count of the total number of valid * elective episodes generated by Trauma & Orthopaedic waiting lists in South Thames Region BY quarter of 'admission' BY hospital
Table 3.4	Estimating the period-specific conditional likelihood of elective admission within three months. Trauma & Orthopaedics at St. Helier's NHS Hospital Trust (RAZ)
Table 3.5	Adjusting published estimates of the proportion of <u>all elective admissions</u> , admitted within three months $(q_0^{admissions})$ , to allow for historical changes in recruitment rates $(q_0^r)$ , in admission rates $(q_0^R)$ , and the combined effect of historical changes in both $(q_0^{Rr})$
Table 4.1	Count of the number of valid * elective episodes generated by Trauma & Orthopaedic waiting lists in South Thames Region BY quarter enrolled BY hospital BY financial year episode finished
Table 4.2	Estimating the period-specific conditional likelihood of admission within three months among those 'admitted' electively. Trauma & Orthopaedics at St. Helier's NHS Hospital Trust (RAZ)
Table 4.3	Three estimates of the cumulative likelihood of admission among those 'admitted' electively from Trauma & Orthopaedic waiting lists in South Thames Region BY hospital
Table 4.4	Two estimates of the cumulative likelihood of admission within three months among those 'admitted' electively for Trauma & Orthopaedic surgery at St. Helier's NHS Hospital Trust (RAZ) BY quarter of enrolment
Table 5.1	Internal consistency of KH06, KH07A and KH07 returns: who counts in official waiting times for England and who doesn't? (1 July to 31 December inclusive)
Table 5.2	Counts of those listed on the English waiting list around 30 September 1994
Table 5.3	Are there four alternative measures of the 'time-to-admission' of those listed on the waiting list in England around 30 September 1994?
Table 6.1	Internal consistency of KH06, KH07A and KH07 returns for period 1 July to 31 December 1994 inclusive BY specialty (England)

Table 6.2	Ratio of valid * elective episodes (HES) to KH06 admissions BY specialty BY quarter of admission
Table 6.3	Counts of those listed on the English waiting list for Trauma & Orthopaedics (110) around 30 September 1994
Table 6.4	Are there four alternative measures of the 'time-to-admission' of those listed on the English waiting list for Trauma & Orthopaedics around 30 September 1994?
Table 6.5	Percentage still awaiting elective admission at 92 days BY specialty (England)
Table 6.6	Percentage still awaiting elective admission at 365 days BY specialty (England)
Table 6.7	Proportion of 'waits' ending in admission i.e., the likelihood of 'having been admitted', between 1 July and 31 December 1994 inclusive BY specialty (England)
Table 6.8	Internal consistency of KH06, KH07A and KH07 returns for period 1 July to 31 December 1994 inclusive. Trauma & Orthopaedics BY hospital (South Thames Region)
Table 6.9	Ratio of valid * elective episodes (HES) to KH06 admissions from Trauma & Orthopaedic waiting lists in South Thames Region BY quarter of admission BY hospital
Table 6.10	Proportion of Trauma & Orthopaedic (110) 'waits' ending in elective admission i.e., the likelihood of 'having been admitted', between 1 July and 31 December 1994 inclusive BY hospital (South Thames Region)
Table 7.1	An abridged PERIOD lifetable of the cumulative likelihood of 'surviving' first-selection from the Orthopaedic waiting list at Kingston Hospital NHS Trust (RAX) between 1 July and 31 December 1994 - prepared using the <u>Kaplan-Meier</u> assumption about tied event times
Table 7.2	An abridged PERIOD lifetable of the cumulative likelihood of 'surviving' first-selection from the Orthopaedic waiting list at Kingston Hospital NHS Trust (RAX) between 1 July and 31 December 1994 - prepared using the number of tied queuing positions to estimate the number of 'first-active-waits' at-risk

Pages  
Missing  
not  
Available

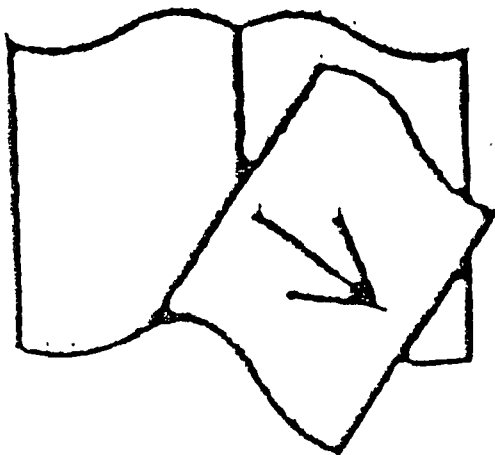

## Preface

I would like to thank the Research & Development Directorate, South Thames Regional Office, for sponsoring me through the Research Training Fellowship Scheme, for extending the initial contract to three years to allow submission of this thesis and for agreeing to purchase gallingly expensive electronic extracts from the *Hospital Episode Statistics*.

I want to thank Dr. Richard Gibbs, Chief Executive - Kingston & Richmond Health Authority, for providing access to the Patient Information Database throughout 1996 and to a warm office, fast computer and knowledgeable workmates throughout the term of this research. I am indebted to Paul Wood for his expertise with the SCAN software and to Rita Shaw for her detailed knowledge of day to day waiting list management. I would also like to thank Cathie Black and colleagues at South Thames IM&T Unit for providing continued access to the Patient Information Database during the first few months of 1997.

I have thoroughly enjoyed working as a research student at the Centre for Population Studies and owe especial thanks to my supervisor Andy Sloggett, who allowed me to take his original idea and use it to pursue my own particular line of enquiry.

Paul W. Armstrong,  
PhD student,  
Centre for Population Studies,  
49-51 Bedford Square,  
London, WC1B 3DP

21 December 1998

I would also like to thank my examiners Dr. Andrew Hinde, Department of Social Statistics - University of Southampton, and Dr. Alison MacFarlane, Department of Epidemiology & Public Health - University College London. Their painstaking reading and exacting criticism allowed me to improve the clarity and accuracy of this thesis. In particular, Dr. Hinde went to considerable lengths to check the formulae developed in Chapter 3 for which I am very grateful.

Paul W. Armstrong,  
Senior Lecturer - Health Services Research,  
Department of Health Sciences,  
University of East London,  
Romford Road,  
London, E15 4LZ

25 January 2000

### **Introduction**

#### From proposal to PhD

*“How far I have succeeded ... I now offer to the world’s censure. ... For herein I have, like a silly schoolboy, coming to say my lesson to the world (that peevish and tetchy master) brought a bundle of rods wherewith to be whipped for every mistake I have committed.”*

Graunt J. *Journal of the Institute of Actuaries*, 90(1), 14 (1964) <sup>1</sup>.

Patients are put on waiting lists because not everyone can be treated at the time they present to a clinician. Rationing takes the form of immediate treatment for some and delayed treatment for others and is justified on the grounds that some patients are better able to wait than others. Clinicians are allowed to discriminate between those who are in immediate danger and those who are not i.e., between those requiring emergency treatment and those that can be treated on an elective basis at some later date, and they continue to discriminate between one patient and another in this manner when they come to schedule their outstanding elective workload. Patients classed as ‘urgent’ must be admitted from the waiting list before those classed as ‘routine’. But prompter treatment for one patient necessarily means delayed treatment for another and as ‘time-since-enrolment’ increases so does the probability of some competing event e.g., of something happening that prevents treatment on the elective basis agreed. The Royal College of Surgeons <sup>2</sup> states that patients with the same clinical condition must be selected in strict order of recruitment to the list. Having distinguished patients with one condition from patients with another, there is no justification for any further distinction so they are admitted on a ‘first-come, first-served’ basis making their waiting times as similar as possible.

In 1995, the author reported Kaplan-Meier survival functions for cohorts of patients enrolled on a waiting list for Plastic & Burns surgery <sup>3</sup>. There was good evidence that the five-category classification of clinical urgency determined the promptness with which surgeons selected patients but the shape of the functions were not what had been expected. There was little evidence of maximum waiting times and the survival function for ‘urgent’ and ‘very urgent’ categories could have been produced by a process of random selection or by reverse queuing i.e., ‘last-in, first-out’. Once the waiting list is up-to-date and due priority has been given to clinical condition, departures from strict queuing is the worst form of waiting list mismanagement possible. Any departure from the guidance issued by the Royal College of Surgeons means that some patients waited longer than was strictly necessary while others ‘jumped-the-queue’.

The proposal submitted to South Thames R&D Directorate aimed to assess whether there was any evidence of queuing within Trauma & Orthopaedic waiting lists. At the time, the Patient Information Database (South West Thames Region) captured information on 13 Trauma & Orthopaedic units and on only a single Plastic & Burns centre so we decided to study the specialty with the second most problematic waiting list in the region. As a result, although there may be many better waiting lists in England these were not chosen for being the worst.

We thought there might be bias in the data (appendix 1) but it was not until we came to look at the official statistics that we realised there might be bias in the method. We could not reconcile the Government Statistical Service method with the principles implied by survival analysis yet the approach seemed to have been used almost universally. Clearly, we would have to provide a robust justification for using lifetable techniques instead of the established approach if our results were to have any credibility in this field. In fact, the thesis became an assessment of the problem of bias in Government Statistical Service estimates of the cumulative likelihood of elective admission among all those at-risk.

We planned to use information extracted from the Patient Administration System<sup>4</sup> using the Patient Information Database<sup>5</sup>. We designed a SCAN<sup>6</sup> question which produced lifetable output and could be downloaded and presented in Excel<sup>7</sup> as Kaplan-Meier survival functions, with 'time-since-enrolment' measured in days. We hoped this would become a routine report for waiting lists within the former South West Thames. Unfortunately, a decision was taken not to support continued region-wide use of the Patient Information Database so the SCAN question swiftly became redundant. Instead, chapters 3-6 use data that is routinely collected by the Department of Health so that other researchers can verify our methods and use them to describe other provider units and specialties of interest.

#### The waiting list 'population'

This thesis likens waiting lists to a demographic population. Instead of a number of births we have the number of new 'decisions-to-admit' to the waiting list and the number of patients newly 'reset-to-zero'. Instead of deaths we have elective admissions. Instead of immigration we have 'reinstatement' and transfer in from other waiting lists and instead of emigration we have waiting times ending in competing events and patients transferred out to other waiting lists.

But these superficial similarities conceal a number of fundamental differences. In demographic populations, mortality is expressed as a rate because the number of deaths is thought to reflect the frailty of the individual at-risk and therefore the size of the population at-risk. And fertility is expressed as a rate because the number of births is thought to reflect the individual's ability and drive to reproduce and therefore the size of the population at-risk. As a result, we might expect the number of births and the number of deaths to be positively correlated because they are generated by (more or less) the same population at-risk.

Now although we can express the number admitted electively as a ratio of the size of the population at-risk, we do not believe this reflects the same inevitability about elective admission. For example, elective activity tends not to happen outside office hours or at weekends or during the holiday season whereas death is less readily scheduled. Similarly although we can express the number recruited as a ratio of the size of the population at-risk, we do not believe the continued existence of the waiting list depends upon the generation of replacements by those currently enrolled. Instead, if surgeons are busy in the operating theatre then they are probably also busy in the outpatient department so we might expect the number



admitted and the number recruited to be positively correlated because they are generated by (more or less) the same clinicians.

The number of births and deaths generated reflects the size of the population at-risk and because mortality and fertility act in opposite directions, demographic populations are subject to a form of feedback that promotes the development of a stable distribution of age at death. If there is an increase in the number of deaths, the size of the population at-risk decreases and so does the number of births while if there is a decrease in the number of births, the size of the population at-risk decreases and so does the number of deaths: fluctuation in the number of deaths tends to be limited. If there is an increase in the number of births, the size of the population at-risk increases and so does the number of deaths while if there is an increase in the number of deaths, the size of the population at-risk decreases and so does the number of births: fluctuation in the number of births tends to be limited. We know of no equivalent mechanism acting on the waiting list 'population'.

We might expect the numbers admitted and the numbers recruited each quarter to be much more variable than the numbers born or dying, reflecting the scheduled nature of elective activity. As a result, the distribution of 'times-to-admission' need not display the stability that characterises the distribution of 'age-at-death' even if there is a strong correlation between the numbers entering and the numbers leaving the population at-risk: if there is an increase in number of recruits there is no inherent drive to make the number of admissions follow suit. (Births and deaths in demographic populations and recruitment and admission in waiting lists may also be correlated because in the long run, the number leaving the population at-risk cannot exceed the number entering.)

#### Naïve assumptions

*"STATIONARY POPULATION A stable population that has a zero growth rate with constant numbers of births and deaths each year."*

Last JM. *A Dictionary of Epidemiology*, 1995.<sup>8</sup>

*"closed population A population into and out of which there is no migration, and where, as a consequence, population growth depends entirely upon the difference between births and deaths. ... CW"*  
Pressat R. *The Dictionary of Demography*, 1985.<sup>9</sup>

This thesis discusses two fundamental assumptions about the nature of waiting lists which are nowhere stated but everywhere implied, namely that waiting lists can be viewed as stationary and closed populations. The importance of these two assumptions derives from the fact that they are simplifying assumptions, passed without comment yet untrue.

The stationary and closed population assumptions make calculation of waiting times for elective admission very simple and allow a whole raft of additional considerations to be set aside. Unless waiting lists are stationary and closed, existing methods give biased results because they use only part of the relevant data without ensuring that it adequately represents the whole (chapter 2). Unless waiting lists are stationary and closed, we have to decide whether we want cohort-specific or period-specific measures of patient waiting times because they are no longer one and the same thing. Unless waiting lists are stationary and closed,

existing methods have to be corrected to allow for non-stationary recruitment rates, non-stationary admission rates, non-stationary conditional likelihoods and for the fact that not everyone recruited to the waiting list will ever be admitted electively. (Chapters 3 & 4 propose a total of 53 correction factors each of which has to take the value 1.0 if the population is to be considered stationary. Chapter 6 presents one additional correction although each of the nine waiting time categories used in the UK may in fact need to be adjusted by its own unique factor.) And unless waiting lists are stationary and closed, we will have to be more explicit about the mix of clinical priorities and about that part of the waiting list population denied elective admission.

The literature on health service waiting times allows these two assumptions to pass without comment. There is little evidence that these assumptions are being made explicitly, less discussion of the alternative approaches possible and no recognition of the effect of any discrepancy i.e., of what happens to estimates where the population is assumed to be stationary and closed but is not. Yet it would be foolhardy to draw any firm conclusions from the lack of evidence in the literature. The UK Government Statistical Service may be fully aware of the implications of any departure from the closed, stationary waiting list or too happy with the convenient fiction to have thought about the possibility of 'exceptions'.

The Government Statistical Service publishes no formula to show how waiting times are calculated suggesting that the method is too obvious to require formal justification. Now formula 3.1 gives identical results to those laid out in a worked example published by the Government Statistical Service<sup>10</sup>. It is so unremarkable that it barely merits even verbal description and we are prepared to assume it is the approach adopted by default where there is no evidence to the contrary. But if we want more proof that formula 3.1 is correct i.e., that the Government Statistical Service assumes the waiting list to be stationary and closed, we are obliged to make deductions based on official data definitions, published caveats and examples of the way in which the Department of Health interprets these statistics in practice.

The Government Statistical Service defines a series of percentages admitted within a specified 'time-since-enrolment' and cites *Hospital Episode Statistics*<sup>11</sup> as the sole source of data. This dataset is designed to capture records on discharge from and, in any case, not before admission to hospital. It provides no information on patients other than those admitted and therefore can neither confirm nor deny the possibility that the waiting list is open. However, the caveats attached to these statistics in official publications<sup>12</sup>, the usual phrasing of Department of Health citations ("Table 4a shows the percentage of patients who were admitted for treatment within 3 months of the decision to admit. Table 4b shows how many were admitted within 12 months."<sup>13</sup>) and the method of capturing data are all consistent with an assumption that the waiting list is closed. The question of stationarity is even more circumstantial. Formulae 3.4, 3.6 & 3.7 should be calculated using event-based data such as *Hospital Episode Statistics*. But it seems unlikely that formulae such as these would be used and the results published without some written justification. So official waiting times cannot have been adjusted to allow for non-stationarity. Therefore the waiting list is assumed to be stationary.

It is most unlikely that these two assumptions describe the true position. An interest in waiting times surely predicates the possibility of change whether for the better or for the worse. And waiting lists lack the strong feedback mechanism responsible for moving demographic populations to the position of dynamic equilibrium described in stable population theory<sup>14</sup>. Patients who decline an offer of admission or who fail to turn up on the day are put to the back of the queue providing weak positive feedback so that recruitment to the waiting list ‘tomorrow’ depends in part on the size of the waiting list ‘today’. Supplier-induced demand describes negative feedback where recruitment increases to offset reductions in the size of the list<sup>15</sup> e.g., where outpatient activity (recruitment to the list), inpatient activity (admission from the list) and clinical administration (removal from the list) increase or decrease in synchrony<sup>16</sup>. There ‘ought’ to be negative feedback with increases in the size of the waiting list prompting increases in the rate of elective admission. And there ‘ought’ to be negative feedback producing a temporary increase in the rate of removal if patient details are out-of-date rather than up-to-the-minute. But none of these have the status of the fertility schedule<sup>17,18</sup> which links the number of women surviving within each age group to the number of births generated by that population. As a result, we do not believe there is much ground for expecting waiting lists to move in the direction of a more stable distribution of ‘times-since-enrolment’.

#### Flawless data

*“This report includes data supplied by purchasers of health services and by health provider organisations. The Ministry of Health does not confirm the accuracy or comprehensiveness of the supplied data, or of tables, analyses, conclusions, and other information in the report based on that supplied data. ...*

*Accordingly, the Ministry of Health takes no responsibility for any reliance by any person, in whole or in part, on any information in this report, nor does it take responsibility for any error in, or omission from, the report.”*

Ministry of Health. *Purchasing for your Health: 1995/96, 1997.*<sup>19</sup>

Wherever possible, this thesis uses data collated by the Government Statistical Service. The continuing preoccupation with the quality of NHS data was legitimized by the Körner Steering Group<sup>20</sup> when it postponed that part of its remit concerned with methods of analysis. As a result, NHS data may be condemned regardless of the use for which it was intended and NHS research may be viewed with complacency if it rehearses the case against the data with enough severity. Now this thesis aims to show the size, direction and potential impact of four departures from stationary and closed population assumptions i.e., the effect of using the existing method in a setting for which it was not designed. So it uses the available data in order to demonstrate the effect on official statistics were the underlying data true i.e., complete, consistent, reliable, valid, free from measurement error, all other sources of bias and confounding. This thesis will only discuss the quality of the data where it helps explain the methods adopted or where it is a necessary step in assessing results when the data definitions are inconsistent.

Despite the continuing quest for flawless data, miscalculation is still the simplest way of producing wrong results and misinterpretation the most direct route to incorrect conclusions. Indeed when someone else is held responsible for data collection<sup>19</sup>, miscalculation and misinterpretation may well be the only errors which could rest squarely with a Ministry of Health. Be this as it may, the existing approach suffers no lack of precedent. It has been recommended at the most senior level within the NHS e.g., by Benjamin<sup>21</sup>

in 1968 (an influential actuarial scientist and Director of Statistics, Ministry of Health), by the Körner Steering Group<sup>20</sup> in 1982 and, most recently, in Department of Health proposals for a revised set of performance indicators<sup>22</sup>. It is the method which undergirds collection of ‘times-since-enrolment’ in *Hospital Episode Statistics* (1989/90 to-date) and which contributed to the utility of the *Hospital In-Patient Enquiry*<sup>21</sup> series (1953 to 1985). It continues to be widely used by independent researchers<sup>23,24</sup> and was advocated as the method of choice by Don, Lee and Goldacre<sup>25</sup> as recently as 1987. But this could be much more than precedent. The recommendations of the Körner Steering Group presumably reflects the views of its members who included figures such as Cottrell, Goldacre and Mason and may not reflect the dissenting views of those not present such as Williams, West, Hagar and Dias<sup>26</sup> and Yates<sup>27</sup>. Moreover the working of the Group was such that it may have created a consensus of opinion where it did not find one: it certainly determined what information would be collected and how it ‘ought’ to be used. However, it is also noteworthy that the existing method is used by health departments<sup>28,29</sup> and by non-government researchers<sup>30,31</sup> elsewhere.

The existing approach reflects an insistence on timely information that precludes prospective studies and is compounded by widespread ignorance of the period lifetable or ‘synthetic cohort’. In the literature on NHS waiting times, we found only two examples of waiting list lifestables<sup>32,26</sup> both of which describe prospective cohorts. And Mason’s survey of possible approaches<sup>33</sup> makes no mention of the synthetic cohort. This comes as rather less of a surprise when we note that the method has been omitted from standard textbooks on Epidemiology<sup>34</sup>. And it is noteworthy that *Descriptive Epidemiology* which includes extensive discussion of lifetable techniques, was intended to bring together methods hardly known outside their specialist fields of application<sup>35</sup>. Despite Newton’s recent letter in the *Journal of Health Services Research & Policy*<sup>36</sup>, use of lifetable techniques appears to require special justification within Health Services Research and the burden of proof currently lies with those who wish to eschew the existing method. This position is so completely at odds with long-established practice in other fields that the method used by the Government Statistical Service would be viewed as inadequate were we interested in ‘time-to-relapse’<sup>37</sup>, ‘time-to-transplantation’<sup>38</sup> or ‘time-to-death’<sup>39</sup> rather than ‘time-to-elective-admission’.

### Reprehensible practice

*“If not everyone can be assisted, the procedures for placement on the waiting list and for the order of treatment must at least be honest and clear. ...*

*The waiting time for a certain facility can exceed a critical limit, above which there could be said to be irresponsible delay in providing care - thus inadequate quality - or even that care is not being provided. In the latter case, the quality of the care is nought, because it is not provided at all.”*

Government Committee. *Choices in Health Care*, 1992.<sup>40</sup>

The existing method seems to be associated with one particular element of confusion or wishful thinking which resists consideration of alternative approaches and needs to be brought out into the open before we go any further. There has been a great deal of concern in this country with the numbers awaiting elective admission i.e., with the length of the NHS waiting list. And waiting list validation was advocated as a way of ensuring that resources were only allocated to those genuinely ‘at-risk’ of elective admission<sup>41</sup> and as a

way of providing an accurate account of the true position at the time of a census<sup>42,43</sup>. In other words, validation aimed to ensure that waiting list records were 'up-to-the-minute' so that the interval between the actual end of 'wait' and the ostensible end of 'wait' was kept as short as possible. But concern shifted to the length of waiting times for elective admission i.e., to the distribution of admission counts across a series of waiting time categories. And in the process, some researchers failed to recognise that patients correctly excluded from census counts after their end of 'wait' should not be excluded from census counts until their end of 'wait'<sup>44</sup>. Instead, they want to exclude those removed from the waiting list as if they were never really candidates for elective admission and as if it had always been recognised that they would never be admitted<sup>37,45</sup>.

The Government Statistical Service routinely indicates that official waiting times are calculated from the 'times-since-enrolment' of those admitted electively though the clearest published statement comes from Moon who insists that "*Examining admission or throughput data gives a comprehensive picture of waiting lists only if all patients are eventually admitted*"<sup>28</sup>. We believe the existing caveat fails to protect patients, clinicians, managers and politicians from assuming that the cumulative likelihood of admission among those 'admitted' electively is equal to the cumulative likelihood of elective admission among all those at-risk. And every time we examine the official statistics for help in placing a contract<sup>12</sup> or in making a referral<sup>13</sup>, we are invited to collude in ignoring the possibility of an outcome other than elective admission. If this is true, the error cannot be shunned too swiftly: were the deceit deliberate, it would be entirely reprehensible.

This confusion over how to handle waiting times which end in competing events may go some way towards explaining the apparent lack of interest in those denied elective admission; they do not count therefore we need not account<sup>46</sup>. It explains the continuing enthusiasm for waiting list validation as a way of reducing the size of the list<sup>42,43</sup>. And it has left health service researchers 'blind' in a number of areas. For example, let us assume that the interval between actual and ostensible end of 'wait' has now been eradicated. Patient waiting times end either in elective admission or in some competing event because there are no other outcomes possible. And in each instance, the patient is admitted or not admitted depending on whether the event or the competing event occurred first<sup>47,48</sup>. As a result, an increase in admissions might be associated with a decrease in removals as readily as with a decrease in the size of the population still waiting.

#### Inconsistent misinterpretation

*"Mr. Mallon: To ask the Secretary of State for Northern Ireland what assessment he has made of the average waiting periods experienced by (a) patients whose services are purchased by their local health boards and (b) patients of GP fundholders. [3957]*

*Mr. Moss: ... The average waiting time is not calculable because information on patient waiting times is grouped in time bands and is not measured individually. ..."*

*Hansard Written Answers, (part 15), 18 November 1996.<sup>49</sup>*

Despite widespread use of the stationary and closed population assumptions when calculating the likelihood of admission, there are also occasions when they are used inconsistently or not at all. For example,

MacMahon gives a formula for calculating the number of cases of a condition prevalent ( $P$ ) in a population given the number of incident cases ( $I$ ) observed within a specified calendar period and the average duration of the condition ( $D$ ) i.e.,  $P \propto I \cdot D$ <sup>34</sup>. Now where the population is closed and stationary, the rate of incidence and the average duration will be unvarying and the number of additions to the waiting list ( $I$ ) will exactly equal the number of admissions ( $A$ ) from it in each and every calendar period<sup>8</sup>. As a result,  $P = A \cdot D$  and  $D = P/A$ . Although this formula is widely used to calculate waiting list 'clearance times', it seems to have been derived without reference to epidemiology and without a full appreciation of its nature<sup>50,51</sup>. Where the waiting list is closed and stationary, the 'clearance time' equals the average duration of patients' time on the waiting list<sup>35,52</sup>. The Department of Health is so far from recognising this that it claims "... *average waiting time is not calculable ...*"<sup>49</sup> while publishing clearance times. Where the waiting list is open, the number of removals should be added to the denominator i.e., we should calculate  $D = P/(A + R)$ <sup>28</sup>. Clearance times estimate how long it would take to 'turn over' a number of patients equivalent to the stock of the waiting list<sup>50</sup>, given the conditions prevalent at the time: whether the waiting list is closed or open, stationary or not, there is no justification for calculating clearance times as  $D = (P + I)/A$ <sup>53</sup>.

In a similar fashion, it is widely believed that long waiting times are over-represented in cross-sectional measures of patient waiting times as a result of length bias<sup>25,45,47,54</sup>. This seems to be a corruption of the idea that individuals 'destined' to survive a long time are more likely to appear in a census at some point than those 'destined' to survive a short time. In fact, the number of low-priority patients captured by a census will be over-represented relative to the number of high-priority patients regardless of the length of 'time-since-enrolment' of the individuals in question<sup>52</sup>. If the waiting list is closed and stationary, the distribution of the censused 'times-since-enrolment' comes to reflect the distribution of person-time at-risk within the population<sup>14,55</sup> and, were it used as an estimate of the cumulative likelihood of survival on the waiting list, would over-represent the apparent contribution of short waiting times. The existing view could hardly be more wrong!

### Understanding the data model

*"Decision to add a patient to an active waiting list*

*(a) A patient should only be placed on a waiting list for surgery if*

- there is sound clinical indication for operation;*
- there is a real expectation of performing that operation within a reasonable time;*
- the patient is clinically ready to undergo surgery. ... "*

*Guidelines for the management of surgical waiting lists, 1991.*<sup>2</sup>

Patients are normally referred to a consultant by their general medical practitioner, are assessed on an outpatient basis (sometimes over a number of visits) and are only 'admitted' to the waiting list if the patient is likely to benefit from the treatment proposed, if the clinician has a reasonable intention of providing treatment in a timely fashion and if the patient agrees to the course of action prescribed<sup>2,56,57</sup>. For the sake of simplicity, this thesis ignores the period prior to enrolment and assumes that the recorded start date equals the date of the clinician's 'decision-to-admit' to the waiting list which will normally be the same as

the date of the outpatient consultation where the patient gave consent. Although the recorded 'times-since-enrolment' underestimate the length of the actual 'times-since-first-presentation', we assume the assessment of clinical priority in outpatients makes full allowance for severity, impairment, likely rate of progression etc., at the time the patient is recruited to the waiting list. As a result, the cumulative likelihood of surviving admission to any given 'time-since-enrolment' ought to reflect this assessment of clinical priority. The approach provides us with a non-arbitrary set of start dates and end dates which can be used to illustrate the effect of different ways of calculating waiting times.

We note however, that this approach assumes disinterest in how long patients wait having had their first outpatient appointment or having presented themselves in general practice. It also assumes that the electronic waiting list is a 'closed system' so that patients are admitted solely on the basis of recorded characteristics<sup>57</sup> regardless of how long they waited in outpatients<sup>58</sup> or in general practice and regardless of their actual characteristics at any moment in time<sup>41</sup>. (Regrettably, the evidence for and against this intriguing possibility is beyond the scope of this thesis.) Alternatively, it assumes that the recorded characteristics are strongly correlated with the 'body of knowledge' used to determine admission. And neither assumption may be wholly adequate where we want to publish statistics that allow comparison of performance.

A new record is created each time a patient is enrolled on a waiting list so that each patient may have more than one 'waiting list entry'<sup>6</sup> in more than one specialty. Each of these in turn generate a series of consecutive 'waiting list history' records<sup>6</sup>. The first 'history' starts with the clinicians' 'decision-to-admit' to the waiting list, continues with the patient 'actively awaiting' elective admission and ends when the clinician offers the first chance at admission or when the status of the 'waiting list entry' has to be changed because the individual is no longer regarded as actively waiting. Where the patient has been selected for admission, the second 'history' begins with the 'preadmission' where the patient has been allocated a date 'to-come-in', reserved a bed and time in the operating theatre etc., and ends either in admission, hospital cancellation, patient cancellation ('self-deferral') or in a 'failure-to-attend'. Where the patient has been temporarily removed from the waiting list either on medical ('deferred') or on administrative grounds ('suspended'), the second history ends with 'reinstatement' to the active waiting list or in permanent 'removal' from it. Where the patient is admitted electively or permanently removed from the waiting list, the event of interest or the competing event are attributed to the start-date and the 'history' is left open-ended. Regardless of the number of histories accumulated against each 'waiting list entry', elective admissions are usually preceded by two other records. In the first, the patient 'actively awaits' elective admission and, in the second, the patient has been 'preadmitted' and is waiting for the scheduled 'to-come-in' date to come round. The structure of this data clearly lends itself to event-history or lifetable analysis.

In the 13 District General Hospitals of the former South West Thames Region, these records were created using the Patient Administration System<sup>4</sup>. This is a live database which is continually expanding with new 'decisions-to-admit' to the waiting list and is also continually being updated each time a patient makes contact with the hospital. It is this data that is used to provide information for the Department of Health whether as quarterly KH06, KH07A and KH07 returns to the Körner Reporting System<sup>56</sup> (appendix 1) or

as annual electronic downloads contributed towards *Hospital Episode Statistics*. Until mid-1997, these records were also copied into the Patient Information Database each night allowing 'waiting list entries' and 'waiting list histories' to be counted or downloaded for further manipulation lists using SCAN<sup>5</sup> (appendix 1).

The Körner Reporting System aims to describe the waiting list in terms of patients e.g., the number of patients admitted, removed, recruited or still awaiting elective admission while *Hospital Episode Statistics* aims to describe the waiting list in terms of episodes of care. The KH06 count of admissions underestimates the number of elective episodes eventually reported and this has been viewed as an indication of the unreliability of the Körner returns. As a result, provider units are required to submit the KP70<sup>11</sup> return in order to validate the *Hospital Episode Statistics*. But the difference between the KH06 count of admissions and the number of elective episodes is unremarkable when we recognise there are two different units of measurement, two different sets of exclusion criteria, two different reporting periods and two different definitions of 'time-since-enrolment'. In Trauma & Orthopaedics, the numerical difference is substantially reduced when we compare the count of KH06 admissions with the number of valid elective episodes i.e., those with non-missing dates of enrolment other than the default value of 15 Oct 1582!

Now the Patient Information Database can count the number of patients on the waiting list or the number of 'waiting list entries' or the number of 'waiting list histories' because each 'patient' record is linked to all the 'waiting list entries' of that individual and each 'waiting list entry' is in turn linked to all the 'waiting list histories' generated to date. In the same way, the Patient Information Database can count the number of patients admitted or the number of admissions or the number of episodes because each 'patient' record is linked to all the individual's admissions and each admission is linked in turn to all the episodes occurring during that inpatient spell. The linking of records in this fashion avoids having multiple copies of each 'patient' record to match with 'entries' and 'histories' in the waiting list module or with admissions and episodes in the inpatient module or with referrals and attendances in the outpatient module etc. But as a result, the Patient Information Database encounters some difficulty when it comes to select and copy these composite records.

Let us imagine there are more than two 'waiting list histories' associated with each 'waiting list entry'. The software links and copies information from the first 'history' and the associated 'waiting list entry' and 'patient' records without any difficulty. But if there are more 'history' records there may be difficulties. The software only allows a single 'pass' at each 'waiting list entry' record held and can only copy one of the possible combinations of 'patient', 'entry' and 'history' records. The procedure documented in appendix 1 avoided this difficulty by downloading information from the linked 'patient', 'waiting list entry' and first 'history' records then downloading information on all subsequent 'history' records. (We used the Statistical Package for the Social Sciences<sup>59</sup> to add the second 'histories' back on to the relevant 'patient', 'entry', 'first history' record.)

A substantial proportion of elective episodes lack a date of enrolment on the waiting list. Let us imagine there is some difficulty copying information from a 'waiting list entry' to the several episodes of inpatient



care associated with it, producing a dataset where only one episode per patient has a non-missing date of enrolment. If elective episodes with enrolment dates indicate the number of patients admitted, it would go a long way towards reinstating the KH06 and KH07A returns as a reliable source of data alongside the KH07 census.

### Glossary

Consultant episode	An episode occurs where a patient receives care under one consultant within one hospital provider before being transferred to another consultant or discharged from care. ( <i>Hospital Episode Statistics</i> capture ‘finished’ and ‘unfinished’ episodes.) The date the episode began may or may not be the date of admission to hospital.
Day case admission	A patient admitted electively during the course of a day for care or treatment which can be completed in a few hours, who does not require a hospital bed overnight. The patient is expected to leave the bed the same day and does so.
‘decision-to-admit’	‘time-since-enrolment’ is measured from the date the clinician decided to admit the patient to the waiting list.
Elective admission	A patient whose admission date is known in advance, allowing arrangements to be made beforehand
‘failed-to-attend’	Patients offered a date for admission who are unable to attend and fail to notify the hospital accordingly. They have their waiting times calculated from the most recent date offered i.e., they are ‘put-to-the-back-of-the-queue’. There is no interval between the ‘failure-to-attend’ and the intended date of admission.
In-patient	A patient who is admitted to hospital either as a day case or for a longer period of time.
KH06	The number of admissions, removals and new ‘decisions-to-admit’ during the quarter (appendix 1).
KH07	The number of patients still ‘at-risk’ of elective admission at the end of the quarter in each three-month waiting time category (appendix 1).
KH07A	The number of patients who refused admission from the waiting list by ‘self-deferring’ or by ‘failing-to-attend’ (appendix 1).
Ordinary admission	A patient who is expected to stay in hospital for at least one night.
‘put-to-the-back-of-the-queue’	What happens to the patient when they ‘self-defer’ or ‘fail-to-attend’.
‘removals’	Patients who have not been admitted to hospital but who have been removed from the waiting list. Includes patients who have died, patients who have been admitted as an emergency for the same condition and patients who have been removed from the list for other reasons.
‘reset-to-zero’	What happens to a waiting time when the original date of enrolment on the waiting list is changed to the date the patient was expected ‘to-come-in’ to hospital.
‘self-deferred’	Patients offered a date for admission who are unable to attend and notify the hospital accordingly. They have their waiting times calculated from the most

recent date offered i.e., they are 'put-to-the-back-of-the-queue'. In the interval between the date of 'self-deferral' and the date for admission, they are not considered at-risk of elective admission.

Specialty All patients are assigned to a clinical specialty according to the responsibility of the consultant in charge of their case.

## References

1. Graunt J. 'Natural and Political observations made upon the Bills of Mortality', *Journal of the Institute of Actuaries*, 90(1), 1-? (1964). (Page 14).
2. The Royal College of Surgeons of England. *Guidelines for the management of surgical waiting lists*, The Royal College of Surgeons of England, London, 1991.
3. Armstrong PW. 'Discrimination or Just Priorities?' *A prospective study of survival on the active waiting list*, [Dissertation], Faculty of Public Health Medicine, London, 1995.
4. Shared Medical Systems Corporation. *Action UK Model In-patient Application Waiting List. Release 5.0. Application Manual*, Shared Medical Systems United Kingdom Ltd., Basingstoke, 1992.
5. The Sollis Partnership. *Writing SCAN questions in PID*, [Training pack], 1995.
6. Healthcare Computing Resources. *SCAN user guide. A comprehensive guide to the SCAN information management toolkit*, Healthcare Computing Resources, London, 1995.
7. Microsoft Corporation. *User's Guide 1. Microsoft Excel. Spreadsheet with Business Graphics and Database. Version 4.0 for Apple Macintosh series or Windows series*, Microsoft Corporation, USA, 1992.
8. Last JM. [Editor], *A Dictionary of Epidemiology*, Oxford University Press, Oxford, 1995. Page 161.
9. Pressat R. *The Dictionary of Demography*, [Edited by Wilson C.], Blackwell, Oxford, 1985.
10. NHS Executive. *Supplement to Department of Health Statistical Bulletin 1996-1. Elective admissions and patients waiting - description of the method used to estimate waiting times of patients admitted from waiting lists*, Government Statistical Service, Leeds, 1996. Page 14.

11. Department of Health. *Hospital Episode Statistics. Volume 3. Finished consultant episodes: waiting time of elective admissions by diagnosis and operation; injury/poisoning by external causes. ENGLAND: Financial year 1994-95*, Government Statistical Service, 1996.
12. NHS Executive. *Health Service Indicators. Background information 1994/95*, Government Statistical Service, FPA-Performance Analysis, Leeds, 1996. WL44, WL92-WL94.
13. NHS Executive. *The NHS Performance Guide 1994-5*, Department of Health, Central Office of Information, Leeds, 1995. Page 15.
14. Hinde A. *Demographic Methods*, Arnold, London, 1998.
15. Gravelle H. 'How do we properly measure changes in waiting list size over time when there is faster throughput of patients for technical reasons?', *Journal of Health Services Research & Policy*, [Letter], 1(3), 172 (1996). [Letter].
16. Newton JN, Henderson J, Goldacre MJ. 'Waiting list dynamics and the impact of earmarked funding', *BMJ*, 311(7008), 783-785 (1995).
17. Namboodiri NK. *Demographic analysis: a stochastic approach*, Academic Press, London, 1991. Pages 160-167.
18. Lotka AJ. 'Relation between birth and death rates', *Science*, [Letter], 26(253), 21-22 (1907).
19. Ministry of Health. *Purchasing for your health 1995/96. A performance report on the third year of the Regional Health Authorities*, Performance Management Unit, Ministry of Health, Wellington, New Zealand, 1997. Page ii.
20. NHS, DHSS. *Steering group on Health Services Information. Chairman: Mrs E. Körner. A report on the collection and use of information about hospital clinical activity in the National Health Service. First report to the Secretary of State*, HMSO, London, 1982. Pages 8, 9, 19 & 87.
21. Benjamin B. 'Hospital Statistics', In: *Health and Vital Statistics*, George Allen & Unwin, London, 1968. Pages 262-264.
22. NHS Executive. *The new NHS Modern and Dependable: A National Framework for Assessing Performance. Consultation document*, FPA, Department of Health, 1998. Page 41.

23. Newton J, Metcalf C, Clinical Standards Advisory Group. 'Access to District elective surgery', In: *District Elective Surgery. Access to and availability of services*, The Stationery Office, London, 1996. Pages 36, 37.
24. Black N, Langham S, Petticrew M, Clinical Standards Advisory Group. 'Waiting times', In: *Coronary artery bypass grafting and coronary angioplasty. Access to and availability of services*, The Stationery Office, London, 1996.
25. Don B, Lee A, Goldacre MJ. 'Waiting list statistics. III. Comparison of two measures of waiting times', *BMJ*, 295, 1247-1248 (1987).
26. Williams DRR, West RJ, Hagard S, Dias AFS. 'Waiting list monitoring using information from hospital activity analysis and SBH 203 returns', *Community Medicine*, 5, 311-316 (1983).
27. Yates JM. *In-patient waiting list statistics. Handle with care. HSMC Occasional Paper No. 16*, Health Services Management Centre, University of Birmingham, 1978. Page 5.
28. Moon L. *Elective surgery waiting lists in Australian public hospitals 1995*, Australian Institute of Health and Welfare (Health Services Series, no. 7), Canberra, 1996. Tables 16-19, 24, A7 & A9. Pages 8, 16, 26, 34.
29. Performance Management Unit, Ministry of Health. 'Medical and Surgical Services', In: *Purchasing for your health 1996/97. A performance report on the fourth year of the Regional Health Authorities*, Performance Management Unit, Ministry of Health, Wellington, New Zealand, 1998.
30. Naylor CD, Levinton CM, Wheeler S, Hunter L. 'Queueing for coronary surgery during severe supply-demand mismatch in a Canadian referral centre: a case study of implicit rationing', *Social Science and Medicine*, 37, 61-67 (1993).
31. Lundstrom M, Stenevi U, Thorburn W. 'Assessment of waiting time and priority setting by means of a national register', *International Journal of Technology Assessment in Health Care*, 12(1), 136-140 (1996).
32. Coid DR. 'Managing the Fife ENT waiting list: The 1989 review of problems', *Health Services Management Research*, 3(2), 82-86 (1990).
33. Mason A. 'An epidemiological approach to the monitoring of hospital waiting list statistics', *Proceedings of the Royal Society of Medicine*, 69, 17-20 (1976).

34. MacMahon B, Pugh TF. *Epidemiology. Principles and Methods*, Little, Brown & Co., Boston, 1970. Page 65.
35. Estève J, Benhamou E, Raymond L. *Statistical Methods in Cancer Research. Volume IV. Descriptive Epidemiology*, [Translated from French by Sinclair M.], International Agency for Research on Cancer (WHO), IARC Scientific Publications No. 128, Lyon, 1994. Preface & Acknowledgements.
36. Newton J. 'How do we properly measure changes in waiting list size over time when there is faster throughput of patients for technical reasons?', *Journal of Health Services Research & Policy*, **1(2)**, 119 (1996).
37. Peto R, Pike MC, Armitage P, Breslow NE, Cox DR, Howard SV, Mantel N, McPherson K, Peto J, Smith PG. 'Design and analysis of randomised clinical trials requiring prolonged observation of each patient. I. Introduction and Design', *British Journal of Cancer*, **34**, 585-612 (1976). (Pages 601-605.)
38. Sharples L, Belcher C, Dennis C, Higenbotham T, Wallwork J. 'Who waits longest for heart and lung transplantation?', *Journal of Heart and Lung Transplantation*, **13(2)**, 282-291 (1994).
39. Gore S. 'Assessing methods -survival', In: Gore SM, Altman DG. *Statistics in Practice*, BMA, London, 1982. Pages 82-85.
40. Government Committee on Choices in Health Care. 'Rationing: who is next?', In: *Choices in Health Care*, Ministry of Welfare, Health and Cultural Affairs, Rijswijk, The Netherlands, 1992. Pages 102, 104.
41. Yates J. *Why are we waiting? An analysis of hospital waiting lists*, Oxford University Press, Oxford, 1987. Page 11.
42. Hart GA, DHSS. *Validation of in-patient waiting lists. DA(84)30*, DHSS, London, 1984.
43. Ministry of Health. *Admission to hospital and hospital waiting lists. HM(62)45*, Ministry of Health, London, 1962.
44. Lee A, Don B, Goldacre MJ. 'Waiting list statistics. II: an estimate of inflation of waiting list length', *BMJ*, **295**, 1197-1198 (1987).
45. Nicholl J. 'Comparison of two measures of waiting times', [Letter], *BMJ*, **296**, 65 (1988).
46. Thomas R. 'Statistics and policy-making', *Radical Statistics*, **71**, 66-73 (1999).

47. Mordue A. 'Comparison of two measures of waiting times', [Letter], *BMJ*, 296, 65 (1988).
48. Collett D. *Modelling survival data in medical research*, Chapman and Hall, London, 1994. Page 4.
49. *Hansard written answers*, 18 November 1996, part 15.
50. Cottrell KM. 'Some problems of definition and a relative measure of waiting time', *Hospital and Health Services Review*, 265-269 (1980). (Page 267)
51. Worthington DJ. 'Queueing models for hospital waiting lists', *Journal of the Operational Research Society*, 38(5), 413-422 (1987).
52. Hennekens CH, Buring JE. *Epidemiology in Medicine*, [Edited by Mayrent SL.], Little, Brown & Co., Boston, 1987. Page 342.
53. Pope CJ, Roberts JA, Black NA. 'Dissecting a waiting list', *Health Services Management Research*, 4(2), 112-119 (1991).
54. Bithell JF. 'Patients on the waiting list of a London teaching hospital', *British Journal of Preventive and Social Medicine*, 24, 241-244 (1970). (Page 241).
55. Chiang CL. *The life table and its applications*, Robert E Krieger, Florida, 1984.
56. Department of Health, NHS Management Executive, Information Management Group. 'Patients awaiting elective admission', In: *The data manual: module 1: hospital services. Version 1.0*, Department of Health, Stanmore, 1992.
57. Churchill K, Howard J, Jayes R. *Managing waiting lists for in-patients and day cases*, Qa Business Services Ltd., Department of Health, Birmingham, 1990.
58. Sanderson HF. 'What's in a waiting list?', *BMJ*, 285, 1368-1369 (1982).
59. Norušis MJ, SPSS Inc. *SPSS for Windows. Base System User's Guide. Release 6.0*, SPSS Inc., USA, 1993.

**Unrepresentative, invalid and misleading: are waiting times for elective admission wrongly calculated?**

**Summary**

In England, the Government Statistical Service reports the percentage of elective admissions that took place within three months of a patient being added to NHS waiting lists. This percentage is calculated from cross-sectional data using the total number of elective episodes within a specified calendar period as denominator and the number of these enrolled on the waiting list less than three months previously as numerator. The approach assumes that NHS waiting lists are closed and stationary populations and has been widely used by government and non-government researchers in the UK and elsewhere. But little attention has been given to the bias introduced when waiting lists are neither stationary nor closed.

This chapter identifies four groups of patients which are excluded from the denominator and criticises the established method for ignoring left and right censored observations. It describes two alternative formulae that would use a limited amount of additional cross-sectional data to produce upper and lower estimates of the cumulative likelihood of admission among those listed. And it recommends the production of unbiased estimates by applying period lifetable techniques to a complete and consistent set of 'times-since-enrolment'.

**Introduction**

Setting the scene

In England, the Government Statistical Service reports the percentage of elective 'admissions' that took place within three months of a patient being added to the waiting list<sup>1,2</sup>. This percentage is calculated from cross-sectional data using the total number of elective episodes<sup>3</sup> within a specified calendar period as denominator and the number of these enrolled on the waiting list less than three months previously as numerator<sup>4</sup>. This statistic is used as a measure of the likelihood of elective admission within three months of recruitment<sup>5</sup>.

Now the number of elective admissions reflects the likelihood of admission and the numbers 'at-risk' of admission within each waiting time category and calendar period of interest. In other words, the number of elective admissions within the 0-3 month waiting time category will increase if there is any increase in the likelihood of admission or in the size of the population exposed to that likelihood. So the size of the numerator accurately reflects conditions within that waiting time category throughout the period of interest.

But the admissions observed in each waiting time category are added together to give an indication of the 'extent of exposure' to the risk of elective admission i.e., the data is handled as though it belonged to a cohort followed to extinction rather than a cross-sectional snap-shot. This assumes that the number of patients eligible for elective admission 3-6 months after enrolment is identical to the number surviving admission from the 0-3 month category although the two groups belong to cohorts of patients which were

recruited quite independently. In other words, the existing approach views the waiting list as a closed<sup>6</sup> and stationary<sup>7</sup> population and only provides an unbiased estimate under these conditions.

Patients, clinicians, managers and politicians all want to know how long people wait for elective admission to hospital. Instead, they are either told about those still waiting<sup>8</sup> or else they are told about those already admitted<sup>3</sup>. Under no circumstance are they given the whole picture, the likelihood of admission experienced by all those on a waiting list between two calendar dates. And the published caveats fail to protect users from equating the likelihoods of admission (within three, six, nine, twelve months etc) among those admitted with the likelihoods of admission (within three, six, nine, twelve months etc) among those listed. After all, the figures hardly address the question of interest unless this is the case!

By definition, *Hospital Episode Statistics*<sup>3</sup> only collects 'event-based data' and does not capture the waiting times of all those eligible for admission from the waiting list. And this is also true of equivalent approaches elsewhere<sup>9,10,11</sup>. But even if we had all the 'times-since-enrolment' recorded in a treatment registry<sup>12,13</sup>, we would still have the same problems if the likelihood of elective admission were estimated using only the waiting times of those already admitted. Unless omissions can be viewed as a random sample of the population of all 'times-since-enrolment', we should expect unrepresentative results. This proposition has received little attention in the literature.

#### Clearing the ground

The method currently preferred by the Government Statistical Service reflects firmly held beliefs about which waiting times count and which do not i.e., official estimates of the likelihood of admission 'ought' to reflect the experience of those admitted and not the experience of those removed. Now exclusion of those removed clearly makes sense when validating waiting lists; we only want to enumerate those who are still eligible for admission at a particular moment in time. But the position is less obvious when we want to measure the 'extent of exposure' which generated elective admissions over a specified calendar period.

Those removed from the waiting list can be divided into two groups by asking whether they were ever really candidates for elective admission<sup>14</sup>. There are those who were never 'at-risk' of elective admission and should never have been added to the waiting list. The patient did not want surgery or the consultant did not agree that an operation was necessary or had no serious intention of ever calling the patient for surgery<sup>15,16</sup>. And there are those who were added to the waiting list in good faith but end up being removed rather than being admitted. The patient's condition may have deteriorated<sup>17</sup> so that the operation is no longer possible or no longer offers the likelihood of any improvement. They may have died waiting<sup>18</sup> or have had to have had the operation as an emergency.

The first group of patients is rightly excluded from all the data because they should never have appeared on the waiting list<sup>16</sup>. They should never be enumerated because they were never eligible for elective admission. And they should never contribute to the denominator used to calculate the likelihood of admission because they could not generate admissions. But we should expect the second group of patients to contribute to the data. They were added to the waiting list because they could have been admitted and some may well have been offered a date 'to-come-in' to hospital. They are only removed from the waiting



list because something other than admission intervened ‘first’<sup>19,20,21</sup>. These patients should be enumerated until the date they were no longer available. And our assessment of the overall ‘extent of exposure’ should include that part of their wait, which preceded removal from the waiting list. At the time of recruitment to the waiting list, it is impossible to distinguish those who will subsequently be admitted from those who will end up being removed<sup>22</sup>.

Imagine a situation where the first type of patient is never added to the waiting list and where records describing the second type are kept ‘up-to-the-minute’. Validation of such waiting lists will not alter the number eligible for admission despite the fact that some of those enumerated go on to be removed at a later date. This provides an alternative explanation for the disappointing results of such exercises in England<sup>23</sup>. Contrary to expert opinion, these patients should not be deleted from waiting list statistics as though they had never been enrolled<sup>24</sup>.

### Aim

This chapter describes the limitations of the method currently used to estimate the cumulative likelihood of elective admission within any given time of enrolment on the waiting list. It argues that the existing formula excludes whole categories of patients who might be considered ‘at-risk’ of admission during the period of interest i.e., it is concerned with the method of calculation rather than the veracity of the data. And although discussion concentrates on the use made of this approach by the Government Statistical Service in England, the method has been widely used by government and non-government researchers in the United Kingdom and elsewhere.

### **Competing events and incomplete observations are omitted**

In England, patients removed from the waiting list are excluded from subsequent censuses because they are no longer eligible for elective admission. In a similar fashion, those deferred on clinical grounds<sup>25</sup> or suspended for administrative reasons are also excluded from census counts for as long as they are not at-risk of elective admission. But when we turn our attention to estimating the cumulative likelihood of elective admission within a given time of enrolment, we rely on *Hospital Episode Statistics*<sup>3</sup> which captures data on the understanding that admission must have already taken place. As a result, the waiting times of these three groups of patients are excluded from calculations as though the individuals had never been added to the waiting list. And the experience of those still awaiting elective admission is also discounted because they cannot appear in *Hospital Episode Statistics* during the period of interest.

The matter is further complicated in England because patients who cancel their admission or fail to arrive as instructed are put to the back of the queue and the date of their enrolment on the list is reset to the date on which they ought to have been admitted<sup>25</sup>. The effect of this is to break the individual’s experience into two parts, the first of which ends in self-deferral or failure to attend rather than in admission. Either part may appear in a census<sup>8</sup> but create particular problems where data capture depends upon admission to hospital.

1. If we measure ‘time-to-admission’ from the revised ‘date of enrolment’, we discount the first part and treat these patients as though they could not have been admitted until after they had been put to

the back of the queue. Yet until they self-deferred or failed to attend, these patients were as much at-risk of admission as anyone else with the same clinical characteristics and the same length of time on the list. In fact, this was so much the case that they were invited to attend for admission. This approach exaggerates the apparent likelihood of admission within a short time of enrolment.

2. An admissions dataset which measures 'time-to-admission' from the original date of enrolment<sup>3</sup> reports the full length of the patient's experience of the waiting list but allocates the whole of the second part, and the eventual admission, to the wrong waiting time categories. This minimises the true likelihood of admission with an official waiting time of less than 3 months.

In England, estimates of the likelihood of elective admission will only reflect day to day practice if the two parts are reported separately and if both contribute to the denominator.

Inpatient waiting times are calculated from partial and unrepresentative data so that no one possesses all the relevant facts. *Hospital Episode Statistics* omit the exposure to risk contributed by those whose waiting time was incomplete at the close of the period of interest. The only occasion where this will not produce bias occurs when the waiting list can be described as a stationary population. In a stationary waiting list, the number enrolled or reset to zero between 1 July and 30 September 1994 would be the same as the number enrolled or reset to zero over the preceding 92 days or over the succeeding 92 days (figure 1). The same equivalence applies to the number at-risk of elective admission at the start of every other waiting time category i.e., at exactly three months, exactly six months etc. And the number still at-risk of admission halfway through each waiting time category would not change from one census to another. In fact in a stationary population, we would get the same distribution of waiting times whether we look at groups of patients who were listed together or groups of patients who were enrolled together. But the hospital waiting list for England would not have attracted so much attention if it were really stationary.

*Hospital Episode Statistics* omit the exposure to risk contributed by those whose waiting time ended in some competing event rather than admission. As a result, the 'times-since-enrolment' used by the Government Statistical Service are conditional on the fact of admission and overestimate the likelihood of elective admission experienced by all those on a waiting list between two calendar dates. As there are several ways of curtailing a patient's time on the list, other than elective admission, the hospital waiting list for England is not in fact a closed population<sup>6</sup>.

#### **Event-based data captures waiting times incompletely**

A number of these points may be made clearer by use of a lexis diagram<sup>26</sup>. Figure 2.1 allows us to show an event, such as elective admission, by plotting the date of admission on the horizontal axis and the length of waiting time at admission on the vertical axis. In the same way, a patient's enrolment can be shown by plotting date of enrolment on the horizontal axis. If we join these two points with a diagonal 'lifeline', we can read off the length of a patient's experience of the waiting list at any date of interest.

Figure 2.1: The English waiting list - the population at-risk of being censused on 30 September 1994 and of generating elective admissions in the same waiting time categories between 1 July and 31 December 1994 inclusive

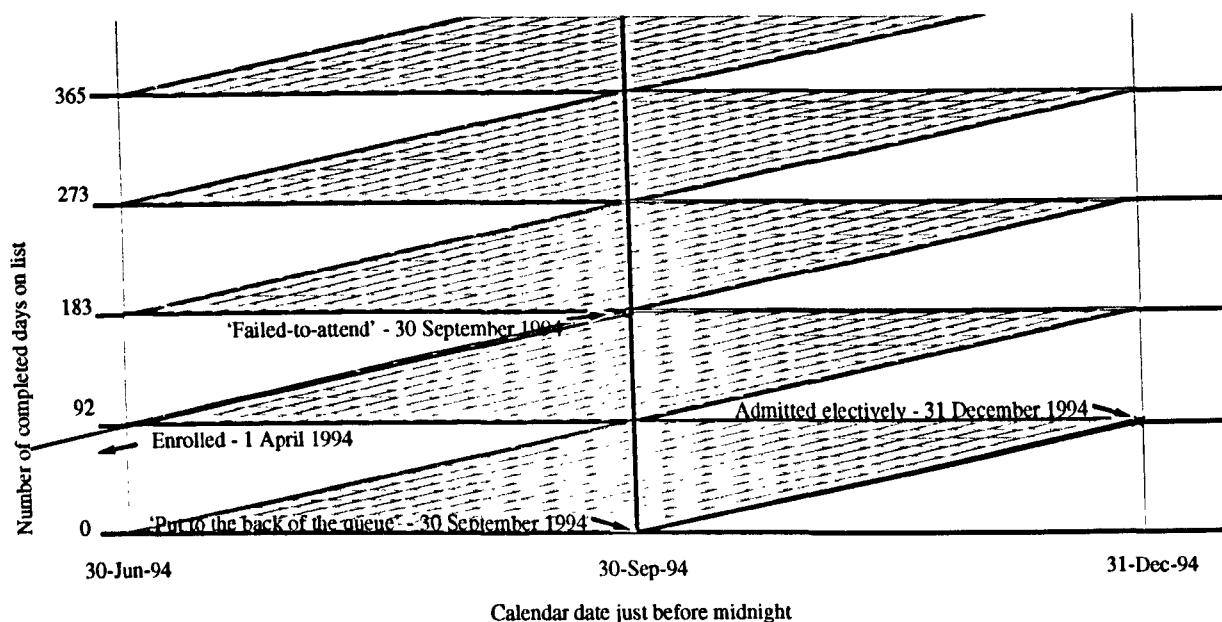

Imagine a patient enrolled on 1 April who failed to attend as instructed 182 days later on 30 September 1994. The patient was put to the back of the queue on that date and eventually admitted after a further 92 days on 31 December 1994. This patient would appear in the 0-3 month category of the censuses of 30 June and 30 September with waiting times of 91 and 0 days respectively. The first part of the patient's wait would be reported as ending in a 'failure-to-attend' during the quarter ending 30 September while the second part would be described as ending in elective admission during the quarter ending 31 December 1994.

The vertical lines in figure 2.1 show censuses conducted just before midnight on 30 June, 30 September and 31 December 1994. The census of the English waiting list counts the number of diagonal 'lifelines' using waiting time categories which are three months wide and which reflect the quarter of enrolment. For example, those recruited to the waiting list in July, August and September 1994 make up the 0-3 month waiting time category censused at 30 September 1994. The counts at midnight on 30 September 1994 reflect the numbers still at-risk of admission halfway through their experience of a waiting time category.

In figure 2.1, each parallelogram contains the group of patients who would be censused in that waiting time category at midnight, 30 September 1994, if they were still at-risk of elective admission. The census counts those who will either survive the waiting time category or else be admitted, removed, reset to zero, deferred or suspended before its close. The census can also be viewed as counting those at-risk at the start of a waiting time category minus the admissions and competing events that precede the census. And an enrolment cohort contributes information on the likelihood of admission from a single waiting time category during the calendar period of interest.

*Hospital Episode Statistics* only collects information on patients who have been admitted and does not capture the waiting times of those removed or of those who have only been reset to zero, deferred or suspended. And even if this were otherwise, event-based data capture would still omit incomplete observations. As a result, event-based data capture cannot tell how many people were at-risk of admission at the start of a waiting time category so the percentage admitted cannot be calculated from *Hospital Episode Statistics* alone.

Figure 2.1 also allows us to distinguish between the waiting times of those listed together and the waiting times of those enrolled together. Patients completing their first nine months on the waiting list between 1 October 1994 and 31 December 1994 belong to two distinct groups. They are members of the group of patients listed together or at-risk of admission during the calendar period of interest i.e., the 'synthetic' cohort. And they are also members of the group of patients enrolled or put to the back of the queue between 1 January and 31 March 1994 i.e., the 'enrolment' cohort. We don't know anything about the initial size of an enrolment cohort or about the subsequent wait of those newly recruited or put to the back of the queue together until we reach the calendar period of interest. The members of the enrolment cohort still on the waiting list at six months then live through the likelihood of admission experienced by the 6-9 month waiting time category of the 'synthetic' cohort between 1 July and 31 December 1994. It is clear that the waiting times of patients listed together are sampled from the waiting times of successive cohorts of patients enrolled or put to the back of the queue together.

#### **Non-random exclusions produce unrepresentative results**

Bias is introduced wherever random samples are discarded because they give unacceptable results. We might eventually find one which supports our presuppositions<sup>27</sup> but having used additional criteria to determine which set of results will be reported, we can no longer claim that the sample was selected at random. Nor can we claim to have conducted an independent test of the study hypothesis: the outcome of the trial was a foregone conclusion!

Bias can also be introduced where we discard part of a study population. Imagine we want to verify that a die generates numbers 1 to 6 at random. We throw the die and record the number which lands uppermost, repeating the procedure so often that we produce a large and cumbersome set of results. So we discard one-sixth of these to make the data more manageable but retain all the 3's because we are really interested in the probability of throwing a 3. As a result, we increase the apparent likelihood of throwing a 3 from  $1/6$  to  $1/5$  even if the die was not loaded.

Discarding data quickly invalidates the results of a study unless the cases excluded are a random sample of the population recruited. The double-blind randomised controlled trial goes to considerable lengths to avoid the destructive effects of bias. Patients are allocated to treatment and control groups at random and the study population preserved from the imposition of additional selection criteria by 'blinding'. As a result, a patient's subsequent decision to drop out of the study or a clinician's subsequent decision to withdraw a patient should bear no relation to treatment status in the trial.

We should expect bias wherever patients are excluded from a study at some point after their initial recruitment unless exclusion occurred at random<sup>22</sup>. But the method used by the Government Statistical Service only excludes waiting times that did not end in admission, reducing the size of the denominator without a commensurate reduction in the size of the numerator. Fortunately, this effect is partly offset by inclusion of the left censored waiting times which ended in admission during the period of interest.

### A proportion, an odds, a ratio or the likelihood of admission?

In order to calculate the proportion admitted ( ${}_n q_x$ ) by the end of a waiting time category ( $x, x + n$ ), we need to know the number at-risk of admission at the start of the category<sup>28</sup>. This can be estimated as the sum of those ending in admission ( ${}_n A_x$ ) or some competing event ( ${}_n C_x$ ) plus those surviving the category ( ${}_n S_x$ ). ( ${}_n C_x$  represents all those whose experience of the waiting list ended when they were removed, reset to zero, deferred or suspended from the list during the category.)

$${}_n q_x = \frac{{}_n A_x}{{}_n A_x + {}_n C_x + {}_n S_x} \quad (2.1).$$

If we left  ${}_n A_x$  out of the denominator in formula 2.1, we would end up calculating the odds of admission from the category. Although this overestimates the probability of admission, the mistake could be easily corrected using simple algebra. Unfortunately, this is not the case if  ${}_n C_x$  or  ${}_n S_x$  are missing; the essential information appears in neither denominator nor numerator and has to be obtained from somewhere else altogether.

The Government Statistical Service calculates the proportion of all elective admissions, admitted by the end of a waiting time category<sup>1,2,5</sup> i.e.,

$${}_n q_x = \frac{{}_n A_x}{\sum {}_n A_x} \text{ e.g., } {}_3 q_0 = \frac{{}_3 A_0}{{}_3 A_0 + {}_3 A_3 + {}_3 A_6 + {}_3 A_9 + {}_3 A_{12} + {}_3 A_{15} + {}_3 A_{18} + {}_3 A_{21} + {}_z A_{24}} \quad (2.2).$$

This omits competing events ( ${}_n C_x$ ) occurring in the category and assumes that the sum of all admissions in 'subsequent' waiting time categories equals the number surviving the category e.g., that

${}_3 S_0 = {}_3 A_3 + {}_3 A_6 + {}_3 A_9 + {}_3 A_{12} + {}_3 A_{15} + {}_3 A_{18} + {}_3 A_{21} + {}_z A_{24}$ . This is untrue. The sum of all 'subsequent' admissions observed in the calendar period of interest omits the sum of all 'subsequent' competing events. And the discrepancy between the denominator used by the Government Statistical Service and that proposed in formula 2.1 may be greater still.

If the size of the waiting list is increasing, the number surviving the category between 1 October and 31 December 1994 will exceed the number surviving the category between 1 July and 30 September 1994 (figure 2.2). Clearly, admissions and competing events are not occurring frequently enough to counter the increase in the numbers enrolled or put to the back of the queue. As a result, the sum of all 'subsequent' admissions plus the sum of all 'subsequent' competing events will underrepresent the number surviving a waiting time category. (The increase in the numbers enrolled or put to the back of the queue will reveal

itself by an increase in the numbers ending in admission or some competing event in appropriate waiting time categories after the close of the calendar period of interest.)

Figure 2.2: The Government Statistical Service approach to estimating the size of the population at-risk of elective admission between 1 July and 31 December 1994 inclusive, where the English waiting list is 'closed' and 'stationary'

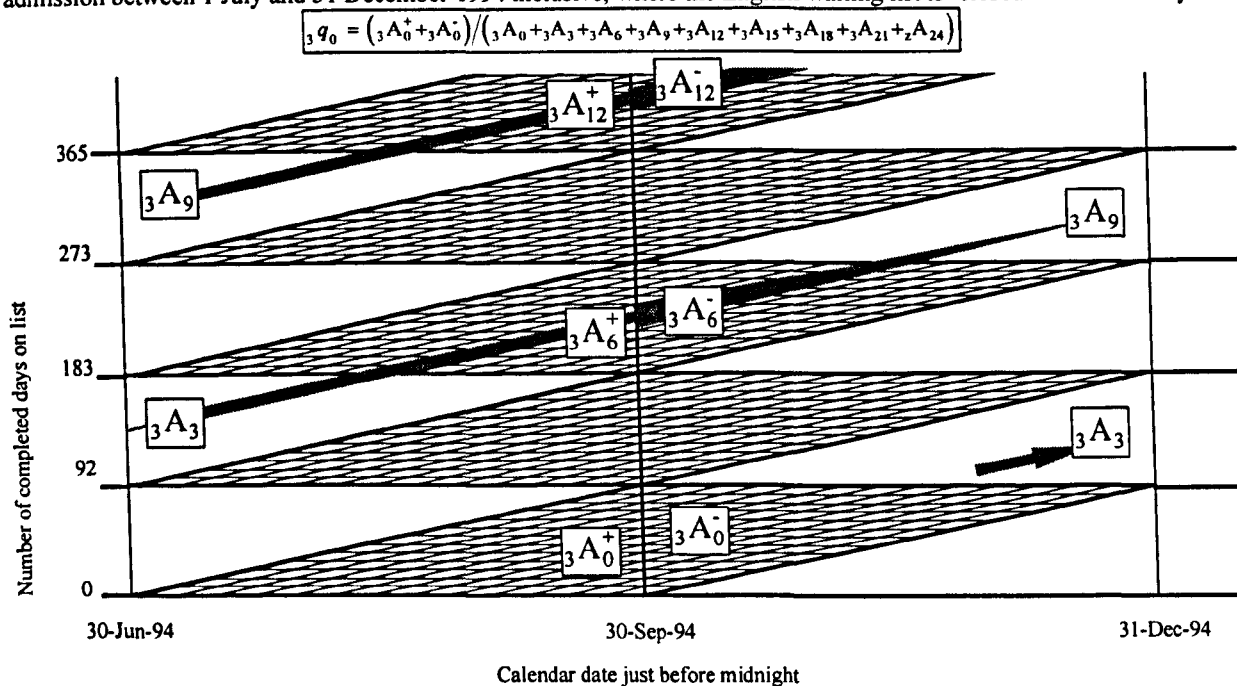

Unfortunately, little of the information needed by formula 2.1 is collected by the Government Statistical Service in England although the position can be improved by rearranging its elements to produce formula 2.3 (below).  ${}_n P_x$  represents the number still at-risk of admission from the category at the time of the census and equals the sum of those surviving the category ( ${}_n S_x$ ) plus those ending in admission ( ${}_n A_x^-$ ) or some competing event ( ${}_n C_x^-$ ) after the census but before the close of the category.

$${}_n q_x = \frac{{}_n A_x^+ + {}_n A_x^-}{{}_n A_x^+ + {}_n C_x^- + {}_n P_x} \quad (2.3)$$

where  ${}_n A_x^+$  and  ${}_n C_x^-$  represent the admissions and competing events that precede the census.

The proportion admitted will only be an accurate estimate of the likelihood of admission if all the admissions from a waiting time category precede all the competing events<sup>29</sup> i.e., if competing events almost fall in the next category. In the absence of any information on the sequence of admissions and competing events, formula 2.4 estimates the likelihood of admission if all the competing events from a waiting time category occur so rapidly that they precede all the admissions. (In this situation, the 'competing events' observed were at-risk of admission so briefly that they contributed almost nothing to the extent of exposure and can be discounted from this waiting time category.)

$${}_n q_x = \frac{{}_n A_x^+ + {}_n A_x^-}{{}_n A_x^+ - {}_n C_x^- + {}_n P_x} \quad (2.4)$$

The true position lies somewhere between formula 2.3 and formula 2.4.

### **Conclusion and recommendations**

The cumulative likelihood of admission estimated for any given 'time-since-enrolment' depends on how we define the population 'at-risk' and on how we handle right and left censored waiting times. As a result, published statistics will be biased because they assume that the waiting list is both stationary and closed and exclude all those not yet or never to be admitted.

In England, we have no information on the 'time-since-enrolment' of patients removed from the waiting list, reset to zero, deferred or suspended. And although we measure the exact 'time-since-enrolment' for most elective episodes, we do so using a different definition from the one we apply when enumerating those still awaiting admission. As a result, we cannot carry out a thoroughly satisfactory empirical assessment of the size and direction of bias in published statistics. Nevertheless we understand that 14% of patients in Australia<sup>9</sup> may expect to be removed from the waiting list for some reason other than admission. Let us assume that all these patients belonged to the second of the two groups discussed earlier. Then clinicians should multiply the published cumulative likelihood for the relevant 'time-since-enrolment' by a factor of 0.86 to estimate the cumulative likelihood which applies to those who are about to join the national waiting list. And as there is no reason to believe that the size and direction of bias will be fixed from one waiting list to another, patients, clinicians, managers and politicians should expect existing comparisons of ranked performance to be misleading.

Cumulative likelihoods of elective admission ought to be estimated by applying period lifetable techniques to a complete and consistent set of 'times-since-enrolment'. This approach could be applied with little further ado to the Swedish National Cataract Register<sup>13</sup> or to the register maintained by the Adult Cardiac Care Network of Ontario<sup>12</sup>. But countries which collect waiting times conditional on the occurrence of an event such as admission (England, Australia and New Zealand) will have to begin by collecting information on the 'time-since-enrolment' of each patient recruited to their waiting list. This information should record the reason why patients were removed from the list and will allow researchers to assess whether censoring is informative or non-informative. In the meantime, stable population theory (chapters 3 & 4), period lifetable techniques (chapter 5) and conditional probabilities (chapter 6) suggest lines of enquiry that may give some idea of the size of the problem.

### **References**

1. Department of Health. *Statistical Bulletin. Elective admissions and patients waiting: England at 31 March 1994*, Government Statistical Service, Leeds, 1994. Page 1.
2. NHS Executive. *Health Service Indicators. Background Information 1994/95*, Government Statistical Service, FPA-Performance Analysis, Leeds, 1996. WL44, WL92-WL94.

3. Department of Health. *Hospital Episode Statistics. Volume 3. Finished consultant episodes: waiting time of elective episodes by diagnosis and operation; injury/poisoning by external causes. ENGLAND: Financial Year 1994/95*, Government Statistical Service, 1996.
4. NHS Executive. *Supplement to Department of Health Statistical Bulletin 1996-1. Elective admissions and patients waiting – description of the method used to estimate waiting times of patients admitted from waiting lists*, Government Statistical Service, Leeds, 1996. Page 14.
5. NHS Executive. *The NHS Performance Guide 1994-95*, Department of Health, Central Office of Information, Leeds, 1995. Page 15.
6. Pressat R. *The Dictionary of Demography*, [Edited by Wilson C.], Blackwell, Oxford, 1985.
7. Last JM. [Editor], *A Dictionary of Epidemiology*, Oxford University Press, Oxford, 1995. Page 161.
8. Department of Health, NHSME. *Hospital Waiting List Statistics: England at 30 September 1994*, Government Statistical Service, Finance and Corporate Information Division, Branch MIAB, Leeds, 1994.
9. Moon L. *Elective surgery waiting lists in Australian public hospitals 1995*, Australian Institute of health and Welfare (Health Services Series, no. 7), Canberra, 1996. Pages 6, 17, 26.
10. Coyte PC, Wright JG, Hawker GA, Bombardier C, Dittus RS, Paul JE, Freund DA, Ho E. 'Waiting times for knee-replacement surgery in the United States and Ontario', *New England Journal of Medicine* 1994; 331(16): 1068-1071.
11. Performance Management Unit, Ministry of Health. 'Medical and Surgical Services', In: *Purchasing for your health 1996/97. A performance report on the fourth year of the Regional Health Authorities*, Performance Management Unit, Ministry of Health, Wellington, New Zealand, 1998.
12. Naylor CD, Sykora K, Jaglal SB, Jefferson S. 'Waiting for coronary artery bypass surgery: population-based study of 8517 consecutive patients in Ontario, Canada. The Steering Committee of the Adult Cardiac Care Network of Ontario', *Lancet* 1995; 346(8990): 1605-1609.
13. Lundstrom M, Stenevi U, Thorburn W. 'Assessment of waiting time and priority setting by means of a national register', *International Journal of Technology Assessment in Health Care* 1996; 12(1): 136-140.
14. Hennekens CH, Buring JE. 'Measures of disease frequency and association', In: *Epidemiology in Medicine*, [Edited by Mayrent SL.], Little & Brown, Boston, 1987. Page 61.



15. The Royal College of Surgeons of England. *Guidelines for the Management of Surgical Waiting Lists*, The Royal College of Surgeons of England, London, 1991. Page 2.
16. Churchill K, Howard J, Jayes R. *Managing waiting lists for in-patients and day cases*, Qa Business Services, Department of Health, Birmingham, 1990. Pages II/6, III/8.
17. Tomlinson M, Cullen J. 'A clinical audit of patients on an orthopaedic waiting list for greater than two years', *New Zealand Medical Journal*, **105**, 266-268 (1992).
18. Donaldson LJ, Maratos JI, Richardson RA. 'Review of an orthopaedic in-patient waiting list', *Health Trends*, **16**, 14-15 (1984).
19. Nicholl J. 'Comparison of two measures of waiting times', [Letter], *BMJ*, **296**, 65 (1988).
20. Mordue A. 'Comparison of two measures of waiting times', [Letter], *BMJ*, **296**, 65 (1988).
21. Collett D. 'Survival analysis', In: *Modelling Survival Data in Medical Research*, Chapman & Hall, London, 1994. Page 4.
22. Peto R, Pike MC, Armitage P, Breslow NE, Cox DR, Howard SV, Mantel N, McPherson K, Peto J, Smith PG. 'Design and analysis of randomised clinical trials requiring prolonged observation of each patient. I. Introduction and Design', *British Journal of Cancer*, **34**, 585-612 (1976). (Page 603.)
23. Yates J. 'Waiting-lists are irrelevant', In: *Why are we waiting? An analysis of Hospital Waiting-lists*, Oxford University Press, Oxford, 1987. Pages 10-12.
24. Lee A, Don B, Goldacre MJ. 'Waiting list statistics. II: an estimate of inflation of waiting list length', *BMJ*, **295**, 1197-1198 (1987).
25. Department of Health, NHS Management Executive, Information Management Group. *The data manual: module 1.0: hospital services. Version 1.0*, Department of Health, Stanmore, 1992. Pages 5/9, 14, 17.
26. Namboodiri NK. 'Life tables', In: *Demographic analysis: a stochastic approach*, Academic Press, London, 1991. Pages 78-80.
27. Huff D. 'The little figures that are not there', In: *How to lie with statistics*, Penguin, London, 1954. Page 37.

28. Estève J, Benhamou E, Raymond L. 'Fundamental concepts', In: *Statistical Methods in Cancer Research. Volume IV. Descriptive Epidemiology. IARC Scientific Publications No. 128*, [Translated from French by Sinclair M.], International Agency for Research on Cancer (WHO), Lyon, 1994. Page 28.
  
29. Kaplan EL, Meier P. 'Nonparametric estimation from incomplete observations', *American Statistical Association Journal*, **53**, 457-481 (1958). (Page 472.)

### **The rise and fall of the NHS waiting list: how do recruitment and admission affect official estimates of the length of 'time-to-admission'**

#### **Summary**

In the UK, the Government Statistical Service (GSS) reports the percentage of elective admissions that took place within three months of a patient being added to the waiting list. This percentage is calculated from cross-sectional data using the total number of elective episodes within a specified calendar period as denominator and the number of these enrolled on the waiting list less than three months previously as numerator. The GSS publishes this statistic as a measure of the likelihood of elective admission within three months of recruitment.

Now the number of elective admissions within 0-3 months reflects the likelihood of admission and the numbers 'at-risk' of admission within the waiting time category and calendar period of interest. In other words, the number of elective admissions within the 0-3 month waiting time category will increase if there is any increase in the likelihood of admission or in the size of the population exposed to that likelihood. So the numerator used by the GSS reflects conditions within the waiting time category throughout the period of interest.

The admissions observed in each waiting time category are added together to give an indication of the overall size of the population eligible for elective admission i.e., the data is handled as though it belonged to a cohort followed to extinction rather than a cross-sectional 'snap-shot'. This total assumes that the number of patients eligible for elective admission 3-6 months after enrolment is identical to the number surviving admission from the 0-3 month category although the two groups belong to cohorts of patients which were recruited quite independently. This total also assumes that each admission 'represents' the same number of patients at-risk regardless of waiting time category. In other words, the existing approach views the waiting list as a closed and stationary population and only provides an unbiased estimate under these conditions.

If waiting lists are not stationary, we should expect the GSS method to produce biased estimates of the likelihood of admission. This paper explores the effect of relaxing stationary population assumptions to the extent apparent in Department of Health data.

#### **Introduction**

##### Background

The numbers recruited to the English waiting list vary from quarter to quarter so that the numbers at-risk of elective admission vary from one enrolment cohort to another. As a result, the number admitted with a waiting time of 0-3 months this quarter may be greater than last quarter simply because there has been an increase in the number of recruits. Yet the Government Statistical Service makes no allowance for this

when it reports the number admitted within three months as a proportion of all those admitted electively during the calendar period of interest.

The numbers admitted from the English waiting list also vary from quarter to quarter so that the numbers surviving elective admission will vary from one enrolment cohort to another even if the numbers recruited were the same. The Government Statistical Service makes no allowance for the fact that the numbers at-risk of elective admission may have increased or decreased immediately prior to the calendar period of interest. Instead, the Government Statistical Service assumes that attempts to reduce the size of the waiting list have been ineffective and were in any case unnecessary because the waiting list shows no tendency to get out-of-hand. The stationary population assumption ignores concerns about the growing size of the English waiting list and dismisses attempts to reduce the numbers awaiting elective admission.

In this chapter we pretend that every patient enrolled on the English waiting list is admitted electively as a matter of course. Although this runs contrary to many of the ideas underlying waiting list validation, there are occasional waiting lists<sup>1,2</sup> where it appears to be a reasonable approximation. And the approach is consistent with the reprehensible but well-established practice of discounting ‘times-to-competing-events’ in Health Services Research<sup>3</sup>. In any case, the assumption allows us to distinguish the effect of incorrectly assuming that the waiting list is ‘stationary’ from the effect of incorrectly assuming that the waiting list is ‘closed’.

### Objectives

This chapter aims to compare the proportion of all admissions, admitted within three months with the period and category-specific likelihood of elective admission allowing for variation in the number enrolled in the preceding enrolment cohorts and for variation in the number admitted over the preceding calendar periods. The direction and extent of the discrepancy will be examined using unpublished Department of Health data on the number newly recruited each quarter and on the total number admitted each quarter.

### **Materials & Methods**

#### The stationary population

In a stationary waiting list, the rate of recruitment will be fixed and unchanging. Ignoring the slight variation in the width of the three-month calendar period (90-92 days) and variable numbers of ‘working days’, this would mean the same number of new ‘decisions-to-admit’ and the same numbers ‘reset-to-zero’ each quarter. In a stationary waiting list, the conditional likelihood of elective admission at any given ‘time-since-enrolment’ also does not change from one enrolment cohort to another. Now if the waiting list is closed, elective admission is the only way of concluding a patient’s experience of the waiting list and the number of elective admissions from the cohort will eventually account for all those originally recruited. And because the conditional likelihoods of elective admission are fixed and operate on the same numbers at-risk at each ‘time-since-enrolment’, the number of elective admissions each quarter will exactly equal the number of new ‘decisions-to-admit’ and the numbers ‘reset-to-zero’ each quarter<sup>4</sup>.

In 1760, Euler<sup>5</sup> recognised it was possible to describe one quantity in terms of another in this remarkable population so that missing data could be inferred from the limited information available. And Lotka<sup>6</sup> recognised that this remained the case even if the numbers ‘recruited’ increased or decreased at a fixed rate. Stable population theory<sup>7</sup> will be used to derive formulae which estimate the likelihood of admission within three months allowing for variation in quarterly rates of recruitment and elective admission.

The Government Statistical Service calculates the proportion of all elective admissions which fall in a particular three-month waiting time category as

$$q_x^{admissions} = \frac{A_x}{\sum A_x} \quad \text{e.g.,} \quad q_0^{admissions} = \frac{A_0}{A_0 + A_1 + A_2 + A_3 + A_4 + A_5 + A_6 + A_7 + A_8} \quad (3.1)$$

where  $x$  represents the start of the three-month waiting time category or ‘quarter’ in which  $A_x$  elective admissions were observed and where  $z$  defines the width of the final waiting time category and does not exceed 8,157 days<sup>8</sup>.

Now these  $A_x$  were generated by the operation of period, cohort and category-specific conditional likelihoods ( $q_x$ ) on those surviving within an enrolment cohort to the waiting time category and period of interest. Regrettably, we have no information on the size of the population at-risk within each waiting time category over any specified calendar period. Let us assume for the moment that the waiting list is both stationary and closed so that the numbers at-risk do not vary from one calendar period to another and so that everyone enrolled can expect to be admitted eventually. As a result, we can estimate the numbers at-risk within each waiting time category as that part of the number originally enrolled which survived to the start of the calendar period and waiting time category of interest.

Let  $N$  represent the unvarying number of ‘decisions-to-admit’ to a stationary English waiting list plus the fixed number ‘reset-to-zero’ each quarter i.e., the total number of ‘recruits’. Let  $q_x$  represent the stationary conditional likelihoods of elective admission from that waiting list over category  $x, x + n$ , where  $n$  equals the width of the three-month waiting time category. Substituting these two terms in formula 3.1 gives a fuller description of the proportion of all elective admissions, admitted over category  $x, x + n$  from the stationary waiting list e.g.,

$$q_0^{admissions} = \frac{q_0 N}{q_0 N + q_1 N(1 - q_0) + q_2 N(1 - q_0)(1 - q_1) + \dots} \quad (3.2).$$

$q_0 N$  represents the number admitted electively within three months of their recruitment to the stationary waiting list,  $q_1 N(1 - q_0)$  represents the number who survive their first three months to be admitted electively three to six months after recruitment to the stationary waiting list and so on. The denominator in formula 3.2 partitions the numbers at-risk of elective admission in the calendar period of interest between the several waiting time categories. It also makes our assumptions explicit. The numbers enrolled and the

numbers surviving each waiting time category are fixed and the conditional likelihoods of elective admission do not vary from one enrolment cohort or from one calendar period to the next.

In fact there are three potential sources of variation each of which may make a fallacy out of the stationary population assumption. In this chapter we use the reported numbers enrolled and the reported numbers admitted to examine the effect of quarterly variation on the size of the population at-risk at each ‘time-since-enrolment’ and on the proportion of all elective admissions admitted within three months. And in the next chapter we examine the effect of category-specific conditional likelihoods that change from quarter to quarter.

### Adjusting for non-stationary recruitment rates

Now the English waiting list is not stationary because the number of ‘recruits’ changes from one quarter to the next (figure 3.1). Let  $N_0$  represent the number of ‘decisions-to-admit’ plus the number ‘reset-to-zero’ in the first quarter of interest i.e., the total number recruited to the cohort generating  $A_0$ , and let  $N_{|0-x|}$  represent the total number recruited to each preceding enrolment cohort. Let  $r_{|0-x|}$  represent the ratio of ‘recruits’ in a preceding quarter to ‘recruits’ in the first quarter of interest so that  $r_1 = N_1/N_0$ ,  $r_2 = N_2/N_0$  and so on. The proportion of all elective admissions, admitted over category  $x, x+n$  during the calendar period of interest then becomes

$$q_0^{\text{admissions}} = \frac{N_0 \times q_0}{N_0 \times q_0 + N_0 r_1 \times (1 - q_0) q_1 + N_0 r_2 \times (1 - q_0)(1 - q_1) q_2 + \dots} \quad (3.3)$$

where  $N_0 r_1 \times (1 - q_0) q_1$  represents the number of recruits the previous quarter who survive their first three months to be admitted electively three to six months after recruitment to the waiting list. This formula gives a more explicit description of the proportion of all elective admissions, admitted within three months, where the conditional likelihoods of elective admission are stationary but operate on enrolment cohorts of varying size.

Now we want to estimate period-specific conditional likelihoods of elective admission which allow for variation in the size of enrolment cohorts ( $q_x^r$ ). And we want to do so using cohort-specific counts of elective admissions within each waiting time category ( $A_0, A_1, \dots, A_8$ ), the number recruited in the first quarter of interest ( $N_0$ ) and the ratio of the number originally enrolled in each preceding enrolment cohort to the number recruited in the first quarter of interest ( $r_1, r_2, \dots, r_8$ ).  $q_1 \times N_0 r_1 (1 - q_0) = A_1$ , the number of elective admissions generated by  $N_0 r_1$  recruits, three to six months after their enrolment on the list. Therefore  $q_1 N_0 (1 - q_0) = A_1 / r_1$ , the number of elective admissions we would have expected three to six months after enrolment on the list given the prevailing period and category-specific conditional likelihoods, had the number of recruits been fixed at the current figure. By substituting equivalent terms in formula 3.3, we obtain the following:

$$q_0^r = \frac{A_0}{A_0 + \frac{A_1}{r_1} + \frac{A_2}{r_2} + \frac{A_3}{r_3} + \frac{A_4}{r_4} + \frac{A_5}{r_5} + \frac{A_6}{r_6} + \frac{A_7}{r_7} + \frac{z A_8}{r_8}} \quad (3.4).$$

We have already seen that the method used by the Government Statistical Service assumes there is no variation in the size of the population at-risk (formula 3.2). Now it is clear that  $q_x^{\text{admissions}}$  only equals  $q_x^r$  where  $N_x = N_0$  so that  $r_x = 1$  for all  $x$ : where  $r_x \neq 1$ , formula 3.1 cannot give the correct result<sup>9</sup>.

Figure 3.1: Recruitment to the Orthopaedic waiting list and elective Orthopaedic 'admissions' from it quarter by quarter at St. Heliers NHS Hospital Trust (RAZ)

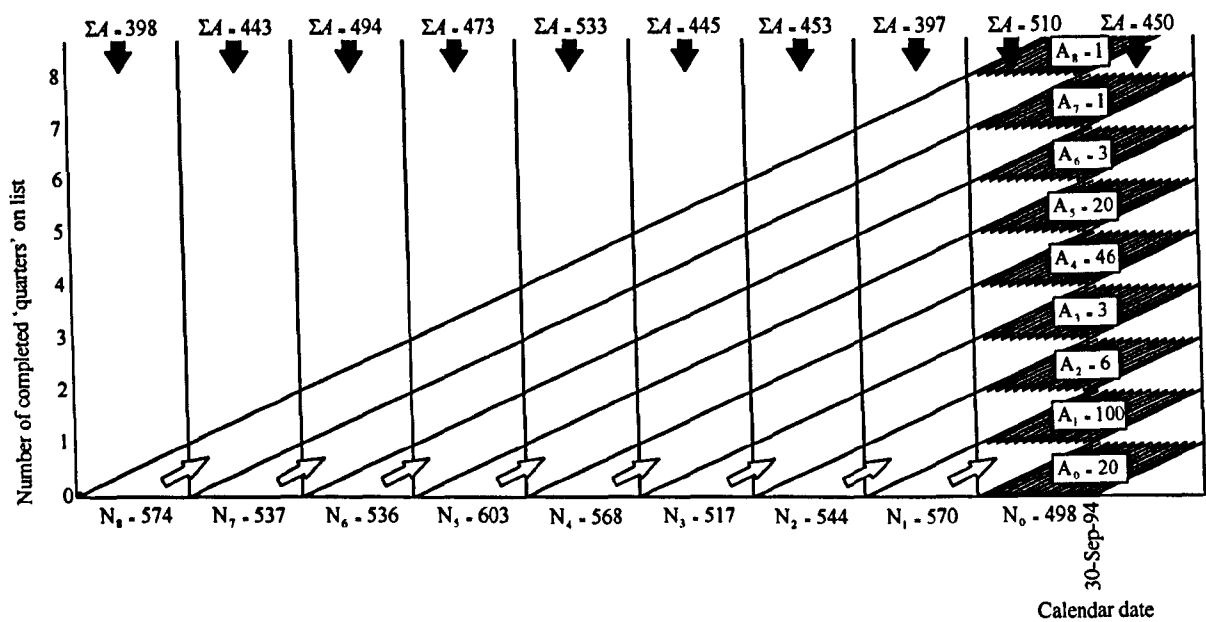

#### Adjusting for non-stationary rates of admission

Formula 3.4 assumes that the number of elective admissions expected only differs from the number of elective admissions observed ( $A_x$ ) as a result of variations in the number of recruits each quarter. It allows us to estimate period and category-specific conditional likelihoods of elective admission regardless of whether  $r_x = 1$  or  $r_x \neq 1$  but, like the Government Statistical Service, assumes that the total numbers admitted electively would not vary from one period to the next if recruitment rates were stationary. This is quite unrealistic and is equivalent to assuming that patients will be admitted electively only 'when their time comes', regardless of all the other factors thought to have an influence.

Let  $R_x$  represent the ratio of elective admissions in a preceding six month period to elective admissions in the six month period of interest (figure 3.1).  $R_x$  represents the degree to which conditional likelihoods in earlier periods were inflated or deflated relative to those prevailing in the period of interest ( $q_x$ ) as a result of period-specific increases or decreases in hospital activity. Now where one cohort is subjected to a

higher likelihood of admission than another yet yields the same number of elective admissions, the number surviving long enough to be at-risk in the first population must have been smaller than the number surviving long enough to be at-risk in the second. As a result,  $q_x^{admissions}$  and  $q_x^r$  can only estimate the period-specific conditional likelihoods ( $q_x$ ) correctly where  $R_x = 1$ . Let  $N$  represent the unvarying number of 'decisions-to-admit' plus the fixed number 'reset-to-zero' each quarter i.e., the stationary rate of recruitment to the waiting list. Substituting  $N$  and  $R_x$  in formula 3.1 gives us

$$q_0^{admissions} = \frac{q_0 N}{q_0 N + q_1 N(1 - q_0 R_1) + q_2 N(1 - q_0 R_2)(1 - q_1 R_1) + \dots} \quad (3.5).$$

We want to estimate period-specific conditional likelihoods of elective admission allowing for historical variation in quarterly admission rates ( $q_x^R$ ). And we want to do so using cohort-specific counts of admissions within each waiting time category ( $A_0, A_1, \dots, A_8$ ), the total number admitted in each quarter ( $\Sigma A$ ), the ratio of the number admitted in each preceding six month period to the number admitted in the six month period of interest ( $R_1, R_2, \dots, R_8$ ) and the unknown period-specific conditional likelihoods ( $q_x$ ). Setting aside variations in the numbers originally recruited,  $N(1 - q_0 R_1)q_1 = A_1$  represents the number recruited the previous quarter who survive their first three months on the waiting list and the admission rates prevailing at the time, to be admitted electively three to six months after recruitment to the waiting list, in the period of interest. So  $N(1 - q_0)q_1 = A_1(1 - q_0)/(1 - q_0 R_1)$  is the number of elective admissions we would expect in the three to six month waiting time category had there been no variation in the total numbers admitted in each of the calendar periods survived. Substituting equivalent terms in formula 3.5 gives us the following:

$$q_0^R = \frac{A_0}{A_0 + A_1 \frac{(1 - q_0)}{(1 - q_0 R_1)} + A_2 \frac{(1 - q_0)(1 - q_1)}{(1 - q_0 R_2)(1 - q_1 R_1)} + \dots} \quad (3.6).$$

By definition  $q_x$  and  $(1 - q_x)$  are stationary so that the numbers admitted in each waiting time category exactly reflect the numbers at-risk during that calendar period. As a result, the conditional likelihood of surviving three months on the waiting list within the reference period  $(1 - q_0) = \frac{\sum A_x - A_0}{\sum A_x}$ ,

$$(1 - q_1) = \frac{\sum A_x - A_0 - A_1}{\sum A_x - A_0}, \quad (1 - q_2) = \frac{\sum A_x - A_0 - A_1 - A_2}{\sum A_x - A_0 - A_1}, \text{ and so on.}$$

#### Adjusting for non-stationary recruitment and admission rates

An identical train of reasoning allows us to specify formula 3.7 which adjusts for variation in the numbers recruited and in the numbers admitted each quarter.



$$q_0^{Rr} = \frac{A_0}{A_0 + A_1 \frac{(1-q_0)}{(1-q_0 R_1)r_1} + A_2 \frac{(1-q_0)(1-q_1)}{(1-q_0 R_2)(1-q_1 R_1)r_2} + \dots} \quad (3.7).$$

Formulae 3.1, 3.4, 3.6 and 3.7 were used to calculate  $q_0^{\text{admissions}}$ ,  $q_0^r$ ,  $q_0^R$  and  $q_0^{Rr}$  for Trauma & Orthopaedic waiting lists at 11 hospitals in South Thames Region around 30 September 1994 (table 3.5).

### Data Required

The Government Statistical Service collates the KH06, KH07 and KH07A returns for England<sup>10</sup> and publishes an aggregated version of the KH07 census alongside a monthly admission rate derived from the KH06 count of admissions<sup>11</sup>. The rest of the data is not routinely published but was made available as an electronic dataset allowing extraction of the number of 'decisions-to-admit' to the waiting list each quarter and of the number of patients self-deferring and failing to attend each quarter. (We will assume that all those self-deferring or failing to attend were put to the back of the queue by having their time on the list 'reset-to-zero' in the same quarter.) These three counts were extracted for each Orthopaedic waiting list in South Thames Region and summed to give the number of 'recruits' each quarter ( $N_x$ : table 3.1) and these were used in turn to calculate the ratio of recruitment in preceding quarters to recruitment in the first quarter of interest ( $r_x$ : table 3.4). No equivalent information exists for elective *Hospital Episode Statistics* so we have assumed that increases and decreases in the number of 'potential' elective episodes may be of the same order of magnitude as the increases and decreases in the number of 'recruits' reported. (Unfortunately, the number of 'potential' elective episodes can only be constructed in retrospect having followed the cohort to extinction i.e., for  $z$  or 8,157 days.) Unfortunately at 30 September 1994, the KH06 and KH07A returns only provide a long enough series of data to construct  $q_0^r$ ,  $q_0^R$  and  $q_0^{Rr}$  for 11 out of 34 Orthopaedic waiting lists in South Thames Region.

In the same way, *Hospital Episode Statistics*<sup>8</sup> publishes a limited number of counts which represent aggregated groups of episodes where each episode represents a record in the electronic dataset for England. IBM United Kingdom Limited copied six variables from each elective episode in the electronic dataset for 1994/95 and supplied the resulting data on CD-ROM. The Statistical Package for the Social Sciences<sup>12</sup> was used to select episodes where dates of recruitment were neither missing nor set to the default value (15 Oct 1582), where dates of 'admission' fell between 1 July and 31 December 1994 inclusive, where waiting times did not take negative values and where elective 'admission' was to Trauma & Orthopaedic (110) units in South Thames Region (Y5). These episodes were then cross-tabulated by enrolment cohort, waiting time category and hospital (table 3.2) providing period, cohort and category-specific counts ( $A_x$ ). The Statistical Package for the Social Sciences was also used to produce period-specific totals ( $\Sigma A$ : table 3.3) which were in turn used to calculate the ratio of the average number of 'admissions' in each preceding six month period to the average for the six month period of interest ( $R_{|0-x|}$ : table 3.4).

## Results

The number of ‘recruits’ each quarter who subsequently end in elective admission can be constructed retrospectively from *Hospital Episode Statistics*. However, patients who are never to be admitted contribute nothing to *Hospital Episode Statistics* while patients yet to be admitted have to be added back in from subsequent periods of data collection. As a result, the number of ‘recruits’ estimated in this fashion probably falls far short of the true position in the most recent quarters of data collection (appendix 3, table 3.1a). If this were not recognised, the number of ‘recruits’ estimated from *Hospital Episode Statistics* would suggest declining recruitment to English waiting lists in the most recent quarters.

Several alternative versions of table 3.3 can be produced i.e., using all elective episodes regardless of whether the date of enrolment is valid or not (appendix 3, table 3.3a), using all elective episodes where the date of enrolment is not missing (appendix 3, table 3.3b) and using the KH06 count of admissions (appendix 3, table 3.3c). Although the presence, direction and extent of bias varies depending on which set of data is used, there is evidence that not all Trauma & Orthopaedic waiting lists in South Thames Region can be assumed to be stationary (table 3.5). As a result, any attempt to correct the published estimates must begin by establishing which version of table 3.3 ought to be used. We recommend counts of elective episodes with valid dates of enrolment because they are the sole source of information on ‘times-to-admission’ (table 3.2). If we want to use any of the other alternatives, we must consider whether the ‘times-to-admission’ associated with them might be different. In other words, table 3.2 is consistent with the version of table 3.3 presented below and not necessarily with any of the alternatives shown in appendix 3.

If the number recruited each quarter has been increasing<sup>13</sup>, the ratio of recruits in each preceding quarter to recruits in the quarter of interest will be  $< 1.0$ . All other factors being equal, it is clear that the denominator used to calculate  $q_0^{admissions}$  (formula 3.1) will be smaller than would have been the case had there been no such increase. As a result, the Government Statistical Service would overestimate the period-specific conditional likelihood of elective admission within three months ( $q_0$ ). In a similar fashion, the Government Statistical Service will overestimate  $q_0$  where the total number of admissions each quarter has been decreasing so that the ratio of admissions in each preceding six month period to admissions in the six month period of interest is  $> 1.0$ . And table 3.4 shows how a decrease in the numbers recruited can combine with an increase in the numbers admitted to exaggerate a Government Statistical Service underestimate of  $q_0$ .

Table 3.5 shows how the adjustments throw doubt on assessments of waiting list performance based on the proportion of all elective admissions, admitted within three months ( $q_0^{admissions}$ ). The values of  $q_0^{admissions}$  from 11 Trauma & Orthopaedic waiting lists in South Thames Region ranged from 27.27% at RDR to 62.32% at RHG i.e., the proportion admitted within three months of enrolment varied from one list to another over a range of 35.05 percentage points. If we allow for non-stationary recruitment and

admission, we have to adjust the values of  $q_0^{admissions}$  by anywhere between  $-9.06$  and  $+5.47$  percentage points. Given the limited range of values taken by  $q_0^{admissions}$ , this represents a substantial error in official estimates of the likelihood of elective admission. (Table 3.5 also shows that values of  $q_0^{admissions}$  may need adjusting by between  $-8.87$  and  $+6.57$  percentage points, by between  $-5.75$  and  $+6.39$  percentage points or by between  $-5.72$  and  $+13.20$  percentage points if we decide to use one of the alternative counts of admissions rather than valid elective episodes.)

Table 3.5 makes it plain that the presence of such an error can only be assessed where we have an adequate series of historical information. In other words, we can only acquit the estimate produced using the official method where we know that recruitment and admission rates were stationary or counteracted one another. Although there were 34 Trauma & Orthopaedic waiting lists in South Thames Region at 30 September 1994,  $q_0^{Rr}$  could only be calculated for 11 of them. As a result, we do not know when the value of  $q_0^{admissions}$  provides a reliable indication of the likelihood of elective admission to any of 23 provider units or when it substantially over- or under-estimates the true position.

$q_0^r$  changes the ranked performance of 4 out of 11 hospitals,  $q_0^R$  changes the ranked performance of 5 out of 11 hospitals and  $q_0^{Rr}$  changes the ranked performance of 5 out of 11 hospitals (figure 3.2: a, b, c). But the significance of the error has little to do with the frequency with which it occurs. Patients who went to the trouble of choosing RDL rather than RDU, RAX, RGW, RAZ or RA1 have clearly been misled by  $q_0^{admissions}$ . If it was important that 52.31% of all admissions were admitted within three months at RDL compared with 49.35%, 48.14%, 47.95%, 43.04% or 42.39% elsewhere then a  $q_0^{Rr}$  value of 43.25% at RDL may well be unacceptable compared with values of 51.80%, 47.12%, 53.42%, 48.29% or 45.90% elsewhere. In other words, every time  $q_0^{admissions}$  are used to identify good practice, place contracts or make referrals, they may reward poor performance and penalise the very people who are prepared to shop around for a prompter service.

## Discussion

### Limitations

Formula 3.7 assumes that the difference between the number of elective admissions observed ( $A_x$ ) and those expected can be explained by historical change in the number recruited to the waiting list each quarter or by historical change in the number admitted from the waiting list each quarter. This allows us to use the observed values of  $A_x$ ,  $r_x$  and  $R_x$  to calculate the number of elective admissions expected in each waiting time category had there been no such change. Unfortunately, this still does not allow for the third or category-specific source of variation because it assumes that each of those admitted reached the usual position in the queue immediately prior to their admission i.e., that one category-specific conditional likelihood does not change relative to another within the same calendar period.

Figure 3.2: Changes in ranked performance as a result of replacing formula 3.1 with formula 3.4 (A), formula 3.6 (B) and formula 3.7 (C)

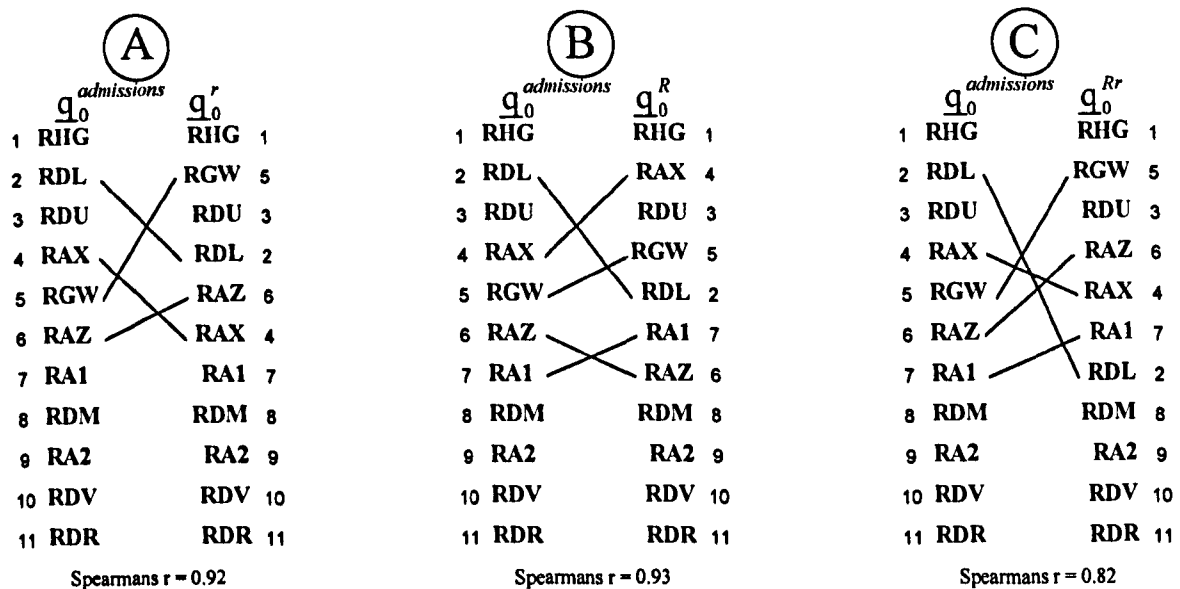

The position of an individual in the queue immediately prior to admission provides the most exact description possible of the likelihood of elective admission with that waiting time that day (chapter 7). It reflects the length of time this individual had been waiting compared with the rest of the list. It reflects the priority assigned to this individual compared with everyone else on the list. And it reflects the total number at-risk of elective admission and the level of surgical activity that day. If patients are not admitted until they reach the usual position in the queue, then there has been no change in relative priority e.g., there has been no change in the mix of urgent and routine cases, the emphasis on long waiting times or the distinction between contracts. And there has been no change in the order in which patients are selected for admission from the list. However if one category-specific conditional likelihood has changed relative to another, estimates of the likelihood of elective admission will have to be adjusted to allow for this third source of variation and chapter 4 explores the effect of non-stationary conditional likelihoods.

In chapter 2 we mentioned various ways in which patients may be shed from the population at-risk without being admitted electively. Removal, like admission, brings the individual's 'time-since-enrolment' to a complete stop. 'Self-deferral' and 'failure-to-attend' wipe out the 'time-since-enrolment' accumulated to-date. Medical deferral and suspension on administrative grounds temporarily remove the individual from the waiting list. As a result, those enrolled have to survive competing events as well as elective admission if they are to appear on the waiting list in the calendar period of interest. And data confined to elective admission only allows us to estimate likelihoods conditional on the fact of admission i.e., estimates only apply to those who will be admitted. The method used by the Government Statistical Service and the alternatives developed in this paper overestimate the likelihood of elective admission where the waiting list is not a closed population (chapter 6).

## Conclusions & Recommendations

This chapter illustrates the effect of assuming that the waiting list is stationary where the rates of recruitment show the sort of variation suggested by the KH06 and KH07A returns and where rates of admission show the sort of variation suggested by valid elective episodes. The period-specific conditional likelihood of elective admission within three months may be overestimated or underestimated by the Government Statistical Service using formula 3.1 and the performance of a waiting list made to appear better or worse than it really is. It is clear that the Government Statistical Service has invoked the stationary population assumption naïvely and, as a result, published estimates should be handled with caution.

We expect the discrepancy between the official estimate and that produced using formula 3.7 to diminish when a number of waiting lists are aggregated and we expect the size and frequency of the discrepancy to increase the more narrowly we define the list of interest. As a result, we should be particularly critical of procedure-specific estimates<sup>1,8,14</sup>, of diagnosis-specific estimates<sup>15</sup> and of estimates prepared for small, geographically defined populations<sup>16</sup>. It seems that the harder we try to eliminate confounding, the more biased Government Statistical Service estimates become.

Wherever possible, an attempt should be made to assess the presence, direction and extent of bias when using formula 3.1. If we are going to use formula 3.7 instead, we will need consistent information on the numbers recruited to and admitted from the waiting list over a sufficient series of quarters. And we still have to assume that waiting lists are closed populations, with the same unchanging mix of priority cases<sup>17</sup> and where patients are selected for admission in the same unchanging order<sup>18</sup>. Chapter 4 takes this approach to its natural conclusion by allowing for non-stationary conditional likelihoods. And chapter 5 illustrates an alternative approach in which we count the numbers at-risk of elective admission in the period of interest, measure the distribution of their waiting times and avoid all these assumptions by using lifetable techniques.

## References

1. Naylor CD, Baigrie RS, Goldman BS, Cairns JA, Beanlands DS, Bennan N, Borts D, Fitchett DH, Haq A, Hess A, et al. 'Assigning priority to patients requiring coronary revascularisation: consensus principles from a panel of cardiologists and cardiac surgeons', *Canadian Journal of Cardiology*, 7(5), 207-213 (1991).
2. Lundstrom M, Stenevi U, Thorburn W. 'Assessment of waiting time and priority setting by means of a national register', *International Journal of Technology Assessment in Health Care*, 12(1), 136-140 (1996).
3. Lee A, Don B, Goldacre MJ. 'Waiting list statistics. II: an estimate of inflation of waiting list length', *BMJ*, 295, 1197-1198 (1987).

4. Last JM. [Editor]. *A Dictionary of Epidemiology*, Oxford University Press, Oxford, 1995. Page 161.
5. Euler L. 'A general investigation into the mortality and multiplication of the human species', [Translated from French by Keyfitz N and Keyfitz B.], *Theoretical Population Biology*, **1**, 307-314 (1970).
6. Lotka AJ. 'Relation between birth and death rates', [Letter], *Science*, **26(653)**, 21-22 (1907).
7. Hinde A. *Demographic Methods*, Arnold, London, 1998.
8. Department of Health. *Hospital Episode Statistics. Volume 3. Finished consultant episodes: waiting time of elective admissions by diagnosis and operation; injury/poisoning by external causes. ENGLAND: Financial year 1994-95*, Government Statistical Service, 1996.
9. Don B, Lee A, Goldacre MJ. 'Waiting list statistics. III. Comparison of two measures of waiting times', *BMJ*, **295**, 1247-1248 (1987).
10. Department of Health, NHS Management Executive, Information Management Group. 'Patients awaiting elective admission', In: *The data manual: module 1: hospital services. Version 1.0*, Department of Health, Stanmore, 1992. Pages 5/15-5/18.
11. Department of Health, NHSME. *Hospital Waiting List Statistics: England at 30 September 1994*, Government Statistical Service, Finance and Corporate Information Division, Branch MIAB, Leeds, 1994.
12. Norušis MJ, SPSS Inc. *SPSS for Windows. Base System User's Guide. Release 6.0*, SPSS Inc., USA, 1993.
13. Newton JN, Henderson J, Goldacre MJ. 'Waiting list dynamics and the impact of earmarked funding', *BMJ*, **311(7008)**, 783-785 (1995).
14. Moon L. 'Long waiting times', In: *Elective surgery waiting lists in Australian public hospitals 1995*, Australian Institute of Health and Welfare (Health Services Series; no. 7), Canberra, 1996. Tables 16, 18, 19, A7.
15. Winyard G. *Cancer waiting times audit. Health Service Circular HSC 1998/014*, NHS Executive, Department of Health, 19 February 1998.

16. Martin S, Smith P. *Modelling waiting times for elective surgery*, Centre for Health Economics, University of York, York, 1995.
17. Pope CJ, Roberts JA, Black N. 'Dissecting a waiting list', *Health Services Management Research*, 4(2), 112-119 (1991).
18. Mullen PM. *Waiting lists and the NHS review*, Health Services Management Centre, University of Birmingham, Birmingham, 1992. Page 2.

Table 3.1: Count of the numbers recruited to Trauma & Orthopaedic waiting lists in South Thames Region

BY quarter enrolled BY hospital

Source:	KH952	KH951	KH944	KH943	KH942	KH941	KH934	KH933	KH932
Quarter:	1994 Q3	1994 Q2	1994 Q1	1993 Q4	1993 Q3	1993 Q2	1993 Q1	1992 Q4	1992 Q3
Hospital	$N_0^*$	$N_1^*$	$N_2^*$	$N_3^*$	$N_4^*$	$N_5^*$	$N_6^*$	$N_7^*$	$N_8^*$
RA1	751	793	762	592	659	491	549	501	579
RA2	512	422	569	592	618	521	558	549	533
RAV	-	-	-	-	-	-	967	829	883
RAX	521	499	428	424	429	353	381	268	361
RAZ	498	570	544	517	568	603	536	537	574
RCY	117	-	-	-	-	-	-	-	-
RDL	922	1,044	1,016	486	661	783	737	851	716
RDM	649	576	633	603	654	570	589	576	431
RDR	23	17	28	20	18	18	21	16	19
RDU	478	598	556	516	415	467	485	478	359
RDV	614	583	589	612	528	536	508	589	572
RG1	449	450	503	503	585	507	-	-	-
RG2	324	310	345	345	288	258	-	-	-



Contd 3.1: Count of the numbers recruited to Trauma & Orthopaedic waiting lists in South Thames Region

BY quarter enrolled BY hospital

Source:	KH952	KH951	KH944	KH943	KH942	KH941	KH934	KH933	KH932
Quarter:	1994 Q3	1994 Q2	1994 Q1	1993 Q4	1993 Q3	1993 Q2	1993 Q1	1992 Q4	1992 Q3
Hospital	$N_0^*$	$N_1^*$	$N_2^*$	$N_3^*$	$N_4^*$	$N_5^*$	$N_6^*$	$N_7^*$	$N_8^*$
RG3	818	1,070	545	545	1,142	679	-	-	-
RGU	444	390	453	453	458	392	-	-	-
RGV	319	409	357	446	418	436	-	-	-
RGW	332	574	401	401	302	375	-	-	-
RGX	86	94	107	107	92	92	-	-	-
RGZ	530	963	454	454	417	426	-	-	-
RHE	298	279	266	312	320	298	-	-	-
RHG	300	333	275	293	295	284	-	-	-
RHH	460	450	514	458	457	439	-	-	-
RJ1	700	885	807	664	396	485	-	-	-
RJ2	879	536	500	441	628	455	-	-	-
RJ6	775	645	694	650	780	614	-	-	-
RJ7	503	483	415	309	191	268	-	-	-

Contd 3.1: Count of the numbers recruited to Trauma & Orthopaedic waiting lists in South Thames Region

BY quarter enrolled BY hospital

Source:	KH952	KH951	KH944	KH943	KH942	KH941	KH934	KH933	KH932
Quarter:	1994 Q3	1994 Q2	1994 Q1	1993 Q4	1993 Q3	1993 Q2	1993 Q1	1992 Q4	1992 Q3
Hospital	$N_0^*$	$N_1^*$	$N_2^*$	$N_3^*$	$N_4^*$	$N_5^*$	$N_6^*$	$N_7^*$	$N_8^*$
RJZ	69	313	78	78	299	350	-	-	-
RN7	369	396	-	-	-	-	-	-	-
RPA	589	641	-	-	-	-	-	-	-
RPC	47	28	-	-	-	-	-	-	-
RPD	382	358	-	-	-	-	-	-	-
RPF	1,117	1,100	-	-	-	-	-	-	-
RPL	699	635	-	-	-	-	-	-	-
RPR	477	449	-	-	-	-	-	-	-
RPS	376	446	-	-	-	-	-	-	-

\* New 'decisions-to-admit' (KH06) plus those self-deferring or failing-to-attend (KH07A) who are assumed to have been 'reset-to-zero' that quarter

Note

The 'boxes' highlight the only occasions when a number appears more than once in a row. It seems likely that some of these are imputed rather than counted.

Table 3.2: Count of valid \* elective episodes sampled from selected enrolment cohorts - 1 July to 31 December 1994 incl.

Trauma & Orthopaedics in South Thames Region BY waiting time category BY hospital

Enrolled:	1994 Q3	1994 Q2	1994 Q1	1993 Q4	1993 Q3	1993 Q2	1993 Q1	1992 Q4	1992 Q3
Hospital	$A_0$	$A_1$	$A_2$	$A_3$	$A_4$	$A_5$	$A_6$	$A_7$	$A_8$
RA1	234	175	90	38	12	1	1	1	0
RA2	146	72	36	33	54	22	22	3	3
RAV	-	-	-	-	-	-	-	-	-
RAX	194	102	51	50	6	0	0	0	0
RAZ	207	100	66	37	46	20	3	1	1
RCY	109	38	46	35	6	0	0	0	0
RDL	272	77	61	40	21	23	15	6	5
RDM	201	104	77	32	33	51	2	0	0
RDR	3	0	4	4	0	0	0	0	0
RDU	189	69	44	41	20	10	3	4	3
RDV	147	117	36	23	57	17	1	0	0
RG1	162	74	29	17	11	13	3	0	0
RG2	129	82	40	31	22	14	8	2	2
RG3	258	77	51	63	59	39	11	2	2

Contd 3.2: Count of valid \* elective episodes sampled from selected enrolment cohorts - 1 July to 31 December 1994 incl.

Trauma & Orthopaedics in South Thames Region BY waiting time category BY hospital

Enrolled:	1994 Q3	1994 Q2	1994 Q1	1993 Q4	1993 Q3	1993 Q2	1993 Q1	1992 Q4	1992 Q3
Hospital	$A_0$	$A_1$	$A_2$	$A_3$	$A_4$	$A_5$	$A_6$	$A_7$	$A_8$
RGU	178	55	29	24	19	22	5	0	0
RGV	151	67	44	16	13	2	1	0	0
RGW	82	32	15	5	21	16	0	0	0
RGX	120	25	28	16	1	0	0	0	0
RGZ	217	39	16	13	11	16	4	0	0
RHE	51	22	34	29	27	45	9	3	3
RHG	129	44	24	5	3	2	0	0	0
RHH	133	68	68	25	27	24	10	5	2
RJ1	214	68	54	37	41	26	11	8	2
RJ2	125	62	34	32	24	18	9	0	1
RJ6	244	113	51	59	45	12	2	0	4
RJ7	158	72	35	17	7	3	1	2	1
RJZ	111	65	44	19	22	32	13	0	0
RN7	147	107	61	30	36	3	1	0	0

Contd 3.2: Count of valid \* elective episodes sampled from selected enrolment cohorts - 1 July to 31 December 1994 incl.

Trauma & Orthopaedics in South Thames Region BY waiting time category BY hospital

Enrolled:	1994 Q3	1994 Q2	1994 Q1	1993 Q4	1993 Q3	1993 Q2	1993 Q1	1992 Q4	1992 Q3
Hospital	$A_0$	$A_1$	$A_2$	$A_3$	$A_4$	$A_5$	$A_6$	$A_7$	$A_8$
RPA	244	75	53	24	24	20	2	0	2
RPC	26	2	0	0	4	0	0	0	0
RPD	158	64	27	28	32	22	6	0	0
RPF	354	119	95	75	60	21	8	3	2
RPL	223	108	59	55	40	33	9	3	3
RPR	79	39	37	37	60	74	9	1	0
RPS	118	93	58	28	10	10	2	0	0

\* Episodes where the date of enrolment was neither blank nor set to '15 Oct 1582'

Table 3.3: Count of the total number of valid \* elective episodes generated by Trauma & Orthopaedic waiting lists in South Thames Region  
BY quarter of 'admission' BY hospital

Specialty	1994 Q4	1994 Q3	1994 Q2	1994 Q1	1993 Q4	1993 Q3	1993 Q2	1993 Q1	1992 Q4	1992 Q3
	$\Sigma A$	$\Sigma A$	$\Sigma A$	$\Sigma A$	$\Sigma A$	$\Sigma A$	$\Sigma A$	$\Sigma A$	$\Sigma A$	$\Sigma A$
RA1	525	558	487	427	333	404	367	414	381	465
RA2	361	364	352	390	415	401	356	397	376	349
RAV	-	-	-	-	-	-	-	-	-	-
RAX	310	439	327	327	266	259	250	247	263	331
RAZ	450	510	397	453	445	533	473	494	443	398
RCY	219	221	272	180	43	-	-	94	232	230
RDL	507	495	582	642	501	427	482	460	454	504
RDM	511	448	461	462	439	445	368	329	377	355
RDR	15	13	15	15	17	6	16	16	6	12
RDU	442	391	454	499	353	242	295	275	238	168
RDV	324	442	451	447	313	277	356	353	375	426
RG1	299	285	249	210	222	260	266	14	-	-
RG2	320	362	363	338	295	268	404	10	2	-
RG3	590	514	423	392	403	473	448	31	-	-

Contd 3.3: Count of the total number of valid \* elective episodes generated by Trauma & Orthopaedic waiting lists in South Thames Region

BY quarter of 'admission' BY hospital

Specialty	1994 Q4 $\Sigma A$	1994 Q3 $\Sigma A$	1994 Q2 $\Sigma A$	1994 Q1 $\Sigma A$	1993 Q4 $\Sigma A$	1993 Q3 $\Sigma A$	1993 Q2 $\Sigma A$	1993 Q1 $\Sigma A$	1992 Q4 $\Sigma A$	1992 Q3 $\Sigma A$
RGU	305	300	288	299	242	279	265	22	-	-
RGV	277	288	265	297	278	282	247	13	-	-
RGW	183	177	207	151	169	171	185	-	-	-
RGX	95	85	93	94	103	86	96	2	-	-
RGZ	307	319	319	273	275	353	379	11	-	-
RHE	207	221	159	225	187	120	152	11	-	-
RHG	175	220	180	220	192	191	223	12	-	-
RHH	384	332	307	333	355	307	341	36	-	-
RJ1	400	462	464	529	474	494	478	42	1	1
RJ2	350	295	354	335	200	306	302	14	1	-
RJ6	474	487	493	518	413	485	442	20	-	-
RJ7	352	262	303	306	144	135	137	25	-	-
RJZ	250	311	290	284	260	266	247	14	-	-
RN7	395	373	414	13	-	-	-	-	-	-

Contd 3.3: Count of the total number of valid \* elective episodes generated by Trauma & Orthopaedic waiting lists in South Thames Region  
 BY quarter of 'admission' BY hospital

Specialty	1994 Q4	1994 Q3	1994 Q2	1994 Q1	1993 Q4	1993 Q3	1993 Q2	1993 Q1	1992 Q4	1992 Q3
	$\Sigma A$	$\Sigma A$	$\Sigma A$	$\Sigma A$	$\Sigma A$	$\Sigma A$	$\Sigma A$	$\Sigma A$	$\Sigma A$	$\Sigma A$
RPA	400	496	523	33	-	-	-	-	-	-
RPC	29	22	34	-	-	-	-	-	-	-
RPD	367	311	376	10	-	-	-	-	-	-
RPF	679	748	623	26	-	-	-	-	-	-
RPL	556	502	479	21	-	-	-	-	-	-
RPR	345	307	261	10	1	-	-	-	-	-
RPS	328	281	329	18	-	1	1	-	-	-

\* Episodes where the date of enrolment was neither blank nor set to '15 Oct 1582'

Note

Small numbers of patients were discharged during a period when 'their' Trauma & Orthopaedic unit contributed data to *Hospital Episode Statistics* but had been admitted before such data capture began. These are shown in italics.



Table 3.4: Estimating the period-specific conditional likelihood of elective admission within three months  
Trauma & Orthopaedics at St. Helier's NHS Hospital Trust (RAZ)

Completed waiting time ('quarters')	'Proportion of all admissions, admitted within three months'			Adjusted for historical recruitment rates			Adjusted for historical admission rates				Adjusted for both		
	$A_x$	$\frac{A_0}{\sum A_x}$	$(1 - q_x)$	$r_x$	$A_x/r_x$	$\frac{A_0}{\sum(A_x/r_x)}$	$R_x$	$\frac{(1 - q_x)}{(1 - q_x R_x)}$	$A_x^R$	$\frac{A_0}{\sum A_x^R}$	$\frac{(1 - q_x)}{(1 - q_x R_x)} \times \bar{r}$	$A_x^R/r_x$	$\frac{A_0}{\sum(A_x^R/r_x)}$
	(3.1)			(3.4)			(3.6)				(3.7)		
0	207	0.4304	0.5696	1.0000	207.0	0.4581	1.0000	1.0000	207.0	0.4546	1.0000	207.0	0.4829
1	100		0.6350	1.1446	87.4		0.9448	0.9600	96.0		0.8387	83.9	
2	66		0.6207	1.0924	60.4		0.8854	0.8920	58.9		0.8166	53.9	
3	37		0.6574	1.0382	35.6		0.9354	0.8654	32.0		0.8336	30.8	
4	46		0.3521	1.1406	40.3		1.0188	0.8885	40.9		0.7790	35.8	
5	20		0.2000	1.2108	16.5		1.0479	0.8644	17.3		0.7139	14.3	
6	3		0.4000	1.0763	2.8		1.0073	0.6846	2.1		0.6360	1.9	
7	1		0.5000	1.0783	0.9		0.9760	0.5808	0.6		0.5386	0.5	
8	1		0.0000	1.1526	0.9		0.8760	0.6185	0.6		0.5366	0.5	
Totals	481				451.9				455.3			428.7	

Table 3.5: Adjusting published estimates of the proportion of all elective admissions, admitted within three months ( $q_0^{admissions}$ ), to allow for historical changes in recruitment rates ( $q_0^r$ ), in admission rates ( $q_0^R$ ), and the combined effect of historical changes in both ( $q_0^{Rr}$ )

Results using alternative sources of data (appendix 3)										
Hospital	Valid episodes	KH06/07A Valid episodes 'recruits'			Non-missing episodes		Elective episodes		KH06 admissions	
	$q_0^{admissions}$	$q_0^r - q_0^{admission}$	$q_0^R - q_0^{admissions}$	$q_0^{Rr} - q_0^{admissions}$	$q_0^R - q_0^{admissions}$	$q_0^{Rr} - q_0^{admissions}$	$q_0^R - q_0^{admissions}$	$q_0^{Rr} - q_0^{admissions}$	$q_0^R - q_0^{admissions}$	$q_0^{Rr} - q_0^{admissions}$
RA1	0.4239	-0.0021	0.0329	0.0351	0.0239	0.0256	0.0163	0.0171	0.0317	0.0337
RA2	0.3734	0.0043	-0.0156	-0.0098	-0.0192	-0.0132	0.0084	0.0120	-0.0115	-0.0057
RAX	0.4814	-0.0316	0.0195	-0.0102	0.0278	-0.0014	0.0187	-0.0115	0.0232	-0.0064
RAZ	0.4304	0.0277	0.0243	0.0525	0.0232	0.0515	0.0392	0.0675	0.0224	0.0506
RDL	0.5231	-0.0368	-0.0508	-0.0906	-0.0492	-0.0887	-0.0200	-0.0575	-0.0239	-0.0572
RDM	0.4020	-0.0189	0.0219	0.0028	0.0219	0.0028	0.0090	-0.0099	0.0188	-0.0002
RDR	0.2727	0.0025	-0.0072	-0.0049	-0.0072	-0.0049	-0.0185	-0.0185	0.0025	0.0025
RDU	0.4935	0.0255	-0.0045	0.0245	-0.0006	0.0286	0.0087	0.0371	-0.0278	-0.0009
RDV	0.3693	-0.0175	-0.0327	-0.0491	-0.0366	-0.0530	-0.0248	-0.0418	-0.0332	-0.0496
RGW	0.4795	0.0519	-0.0008	0.0547	0.0103	0.0657	0.0089	0.0639	0.0679	0.1320
RHG	0.6232	0.0058	-0.0092	-0.0036	-0.0141	-0.0086	-0.0374	-0.0328	0.0006	0.0064

**Trends in waiting times for elective admission: assertion and counter-assertion in the teeth of the evidence?**

**Summary**

In the UK, the Government Statistical Service reports the cumulative percentage of elective 'admissions' that took place within a given 'time-since-enrolment' on the waiting list. These percentages are calculated from cross-sectional data using the total number of valid elective episodes within a specified calendar period as denominator and the number of these who were enrolled on the waiting list three or twelve months previously as numerator.

Now the number of elective admissions from a particular three-month waiting time category reflects the category-specific conditional likelihood of elective admission and the size of the population at-risk within that category during the calendar period of interest. Let us assume that a fixed number of patients are enrolled on this waiting list each quarter, that the same fixed number of patients are admitted electively from it each quarter and that all those enrolled will eventually be admitted electively i.e., the rates of recruitment and admission are stationary and exactly equal and the waiting list is a closed population. The size of the population at-risk within a waiting time category depends entirely on the conditional likelihoods of elective admission survived: the size of the population will be small if the combined conditional likelihoods survived was large.

The relationship between category-specific conditional likelihoods may not vary from one calendar period to another in which case they are stationary and the Government Statistical Service method correctly estimates the cumulative likelihood of elective admission among all those at-risk. Or they may vary. Let us imagine that the conditional likelihood of elective admission from the 0-3 month category is higher than the conditional likelihood of elective admission from the 3-6 month category in one calendar period and that this relationship is reversed in the following calendar period. The population entering the 3-6 month category in the second period represents survivors from the 0-3 month category in the first. As a result, the number of admissions from the 3-6 month category in the second period may be smaller than the number of admissions from the 3-6 month category in the first period even though the conditional likelihood is larger. Where there have been changes in the conditional likelihoods of elective admission, official statistics describe the one truly false position i.e., that where there has been no change.

There is one exception to this paradox. Let us admit the possibility that recruitment and admission rates are not stationary. Where conditional likelihoods change from one period to the next, the method used by the Government Statistical Service can only give correct results if patients were admitted at random i.e., without regard for the length of time already spent waiting. In this situation, each waiting time category has the same conditional likelihood of elective admission although these may vary from one period to the next. Regardless of waiting time category, each admission will represent the same extent of exposure to

risk so that the total number of admissions provides an accurate denominator for calculating the cumulative likelihood of elective admission during a calendar period.

## Introduction

### Background

In chapter 3 we discussed the effect of recruitment and admission rates on Government Statistical Service estimates of the likelihood of elective admission. Here we discuss a third factor that reveals even more problems with official statistics. So far we have assumed that the underlying conditional likelihoods are stationary: they may only vary from one category to another or be inflated or deflated by period-specific changes in hospital activity. Now we must consider the possibility that the relationship between two category-specific conditional likelihoods may vary from one calendar period to the next e.g., as a result of prompter admission of 'long-waiters' or of deciding that a larger proportion of new recruits requires urgent admission.

The Government Statistical Service method can be used to test the assumption of stationarity i.e., to perform the necessary but insufficient check that the proportion of all elective admissions, admitted within each waiting time category, has not changed. But once we concede that conditional likelihoods may have changed, we must also acknowledge that the Government Statistical Service method does not allow us to explore the size and direction of any change. It assumes that each admission represents the same number of 'lifelines' at-risk within each waiting time category. As a result, we cannot compare likelihoods using counts of admissions as our denominator where exposure in a particular category may generate more admissions in one calendar period than another.

### Objectives

This chapter argues that the Government Statistical Service method can be used to describe variation in the proportion of all elective admissions, admitted within each waiting time category. But period and category-specific conditional likelihoods may show more extreme variation, either in the direction suggested by official statistics or in exactly the opposite direction.

## Methods

### Adjusting for non-stationary conditional likelihoods

We want to make a third adjustment that will allow for variation in category-specific conditional likelihoods of elective admission from one calendar period to the next having allowed for variation in  $r_x$  and  $R_x$ . Let  $q_x(t)$  represent category-specific conditional likelihoods in the period of interest and  $q_x(t-x)$  the conditional likelihoods in each preceding period. Let  $\rho_{08} = q_0(-8)/[q_0(0)R_8]$ ,  $\rho_{26} = q_2(-6)/[q_2(0)R_6]$ ,  $\rho_{44} = q_4(-4)/[q_4(0)R_4]$ ,  $\rho_{62} = q_6(-2)/[q_6(0)R_2]$  etc, so that  $\rho_{x,|t-x|} = q_x(t-x)/[q_x(t)R_{|t-x|}]$ . In other words,  $q_x(t-x) = q_x(t)\rho_{x,|t-x|}R_{|t-x|}$ . The Government Statistical Service apportions elective admissions to nine waiting time categories<sup>1</sup> reflecting the fact that the census counts those enrolled over at least nine cohorts, who 'survived' admission over as many as nine

quarters to the time of the census. (In fact the ninth waiting time category captures those enrolled between 730 days and an arbitrary maximum of 8,887 days previously<sup>1</sup>, who survive to the time of the census.) As a result, there may be up to 36 unique  $\rho_{x,|t-x|}$  (figure 4.1).

Figure 4.1: Ratios of period and category-specific likelihoods of elective admission in previous six month periods to those prevailing in the reference period, having allowed for  $r_x$  and  $R_x$

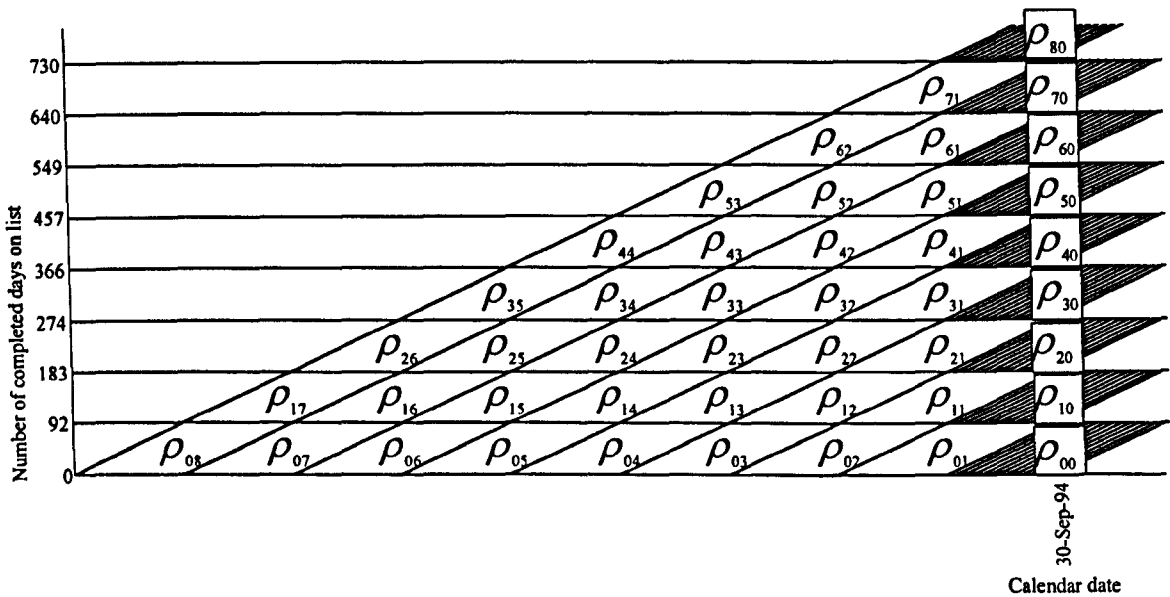

Now where  $\rho_{x,|t-x|} \neq 1.0$ ,  $A_0 = q_0 \rho_{00} R_0 N_0 r_0$ ,  $A_1 = q_1 \rho_{10} R_0 N_0 r_1 (1 - q_0 \rho_{01} R_1)$ ,  
 $A_2 = q_2 \rho_{20} R_0 N_0 r_2 (1 - q_0 \rho_{02} R_2) (1 - q_1 \rho_{11} R_1)$  etc. We want to estimate period and category-specific conditional likelihoods of elective admission regardless of whether  $r_x = 1.0$ ,  $R_x = 1.0$  and  $\rho_{x,|t-x|} = 1.0$  or not. So we adjust the observed cohort and period-specific values of  $A_x$  to remove the effect of all three sets of correction factors e.g.,  $q_0 N_0 = A_0 / (\rho_{00} R_0 r_0)$ ,

$$q_1 N_0 (1 - q_0) = A_1 \left( \frac{(1 - q_0)}{\rho_{10} R_0 r_1 (1 - q_0 \rho_{01} R_1)} \right),$$

$$q_2 N_0 (1 - q_0) (1 - q_1) = A_2 \left( \frac{(1 - q_0) (1 - q_1)}{\rho_{20} R_0 r_2 (1 - q_0 \rho_{02} R_2) (1 - q_1 \rho_{11} R_1)} \right) \text{ etc. But } \rho_{x0}, r_0 \text{ and } R_0$$

equal 1.0 by definition. So substitution in formula 3.1 gives us the following:

$$q_0^{\rho R r} = \frac{A_0}{A_0 + A_1 \left[ \frac{(1 - q_0)}{r_1 (1 - q_0 \rho_{01} R_1)} \right] + A_2 \left[ \frac{(1 - q_0) (1 - q_1)}{r_2 (1 - q_0 \rho_{02} R_2) (1 - q_1 \rho_{11} R_1)} \right] + \dots} \quad (4.1).$$

Let us calculate the expected number of admissions in the 3-6 month waiting time category as

$$q_1 N_0 (1 - q_0) = A_1 (1 - q_0) / r_1 (1 - q_0 \rho_{01} R_1) \text{ and let us multiply both numerator and denominator on the}$$

right hand side of the equation by  $N_0$ . If  $q_1 N_0(1 - q_0) = A_1 N_0(1 - q_0) / N_0 r_1(1 - q_0 \rho_{01} R_1)$  then

$$q_1 N_0(1 - q_0) = A_1 \left[ \frac{(N_0 - A_0)}{N_0 r_1(1 - q_0 \rho_{01} R_1)} \right] \text{ and } q_1 N_0(1 - q_0) = A_1 \left[ \frac{(N_0 - A_0)}{(N_1 - A_0(t-1))} \right].$$

In this version of the formula, the factor used to adjust the number of elective admissions observed in the 3-6 month waiting times category is made plain as the ratio of the number surviving the 0-3 month category during the period of interest to the number surviving the 0-3 month category in the preceding period. In other words, we calculate the number of admissions expected if the population at-risk at the start of the 3-6 month category (1 July to 30 September 1994) had been the same size as the population at-risk at the end of the 0-3 month category (1 October to 31 December 1994). As a result, the denominator used to calculate  $q_0^{PRr}$  should exactly equal  $N_0$ .

Or we can rearrange our formulae so that  $q_0 = A_0 / N_0$ ,  $q_1 = A_1 / N_0 r_1(1 - q_0 \rho_{01} R_1)$ ,

$$q_2 = A_2 / N_0 r_2(1 - q_0 \rho_{02} R_2)(1 - q_1 \rho_{11} R_1) \text{ etc. Now } N_0 r_1 - A_0(t-1) = N_1 - A_0(t-1) \text{ and}$$

represents the number recruited the previous quarter who were not admitted during their first three months on the waiting list. Either way, it becomes evident that formula 4.1 estimates the prevailing conditional likelihoods by making full allowance for the numbers surviving to the start of each waiting time category in the period of interest. In other words neither the Government Statistical Service method (formula 3.1) nor formulae 3.4 and 3.7 make enough allowance for the numbers known to have been recruited and observed to have been admitted prior to the waiting time category and calendar period of interest.

### Data required

*Hospital Episode Statistics* publishes a limited number of counts of records where each record in the electronic dataset for England represents an inpatient episode under the care of a particular clinician. IBM United Kingdom Limited copied six variables from each elective episode in the datasets for 1992/93, 1993/94, 1994/95, 1995/96, 1996/97 and 1997/98 and supplied the resulting data on CD-ROM. (The data for 1996/97 and 1997/98 were still provisional at 29 March 1999.) The Statistical Package for the Social Sciences was used to select episodes where dates of recruitment were neither missing nor set to the default value (15 Oct 1582), where waiting times did not take negative values and where elective 'admission' was to Trauma & Orthopaedic (110) units in South Thames Region. The selected episodes were tabulated by quarter of enrolment giving the total number of episodes generated by each cohort to date ( $N_x$ : table 4.1). The length of 'time-to-admission' was divided by the width of the quarter of enrolment and the resulting value converted to an integer. The selected episodes were then tabulated by quarter of enrolment and waiting time category (figure 4.2) and used to calculate the number surviving in each cohort to the start and at the end of each waiting time category during the period of interest (table 4.2).

## Results

Table 4.1 shows that valid elective episodes in Trauma & Orthopaedic surgery were still being captured five years after the date of their enrolment on the waiting list (RAZ, RDL, RDU, RHH). For the purpose of illustration, we assume these extracts captured every ‘time-since-enrolment’ which survived the period and waiting time categories of interest although patients enrolled between 1 June and 30 September 1994 are followed for less than three years.

Table 4.2 calculates the ratio of the number surviving one waiting time category during the calendar period of interest ( $S_{x0}$ ) to the number surviving the same waiting time category in the previous quarter ( $S_{x1}$ ). These ratios are used to adjust the observed admissions so they reflect the size of the population responsible for generating  $A_{00}$  i.e., to values consistent with stationary rates of recruitment and admission and with stationary category-specific conditional likelihoods of elective admission. Table 4.2 confirms that if the series of  $S_{x0}$  and  $S_{x1}$  values are correct, the sum of the expected admissions from each waiting time category should exactly equal  $N_0$ .

Figure 4.2: Period and category-specific counts of valid elective episodes under Trauma & Orthopaedic surgery at St. Helier’s NHS Hospital Trust (RAZ)

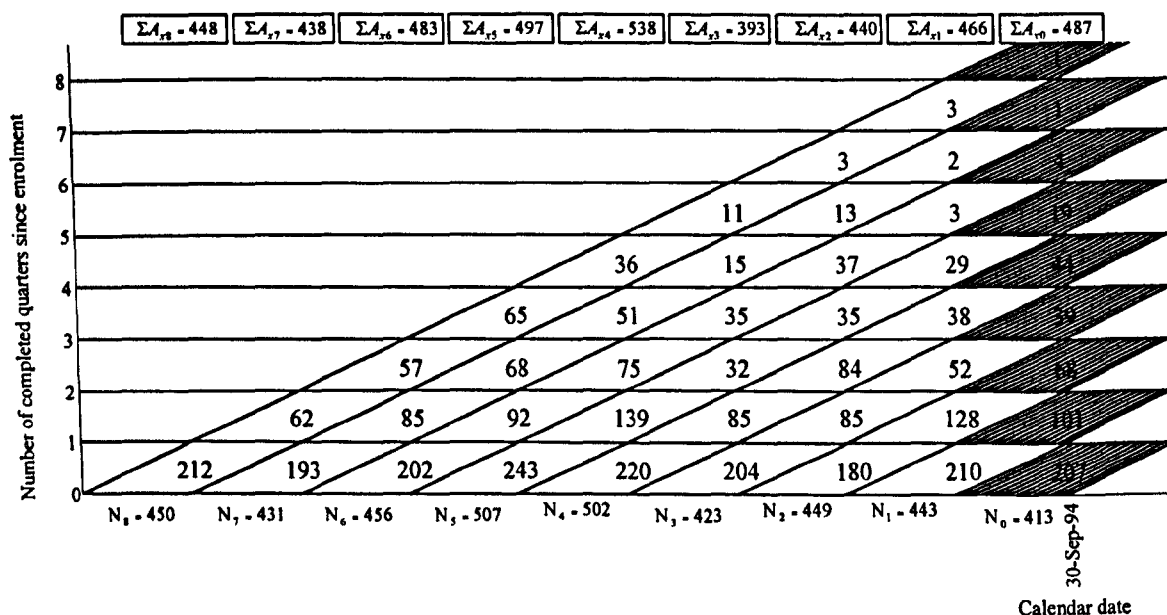

Table 4.3 compares the Government Statistical Service estimate ( ${}_3q_0^{admissions} = A_0 / \sum A_x$ ) with two alternatives that allow for non-stationary rates of recruitment and admission and for non-stationary category-specific conditional likelihoods of elective admission, namely  ${}_3q_0^{PRR}$  and  $A_0 / N_0$ . The sum of the expected admissions from each waiting time category equals  $N_0$  so that  ${}_3q_0^{PRR}$  exactly equals  $A_0 / N_0$  for 17 out of 34 Trauma & Orthopaedic waiting lists. (Where  ${}_3q_0^{PRR}$  does not equal  $A_0 / N_0$ , the simplest explanation is that some of the  $S_{x0}$  and  $S_{x1}$  values are too small i.e., there are ‘times-since-

enrolment' that will not be captured until 1998/99 or later so that some of the  $N_x$  values are too small.) Confining our remarks to the 17 values that are not in any doubt, the cumulative proportion of elective admissions under or over estimate the cumulative likelihood of elective admission by between +6.16 and – 7.62 percentage points. (The  $N_0$  values responsible for generating  $A_0$  allow us to assess whether the difference between the cumulative proportion and the cumulative likelihood is the result of using one small denominator ( $N_0$ ) rather than another ( $\sum A_x$ ) or represents a much more substantial discrepancy.)

Table 4.4 compares the values of  ${}_3q_0^{\text{admissions}}$  with the values of  $A_0/N_0$  over the eight quarters prior to 30 September 1994. It is evident that increases and decreases in the value of the Government Statistical Service estimate do not have to be matched by a commensurate increase or decrease in the value of  $A_0/N_0$ .

## Discussion

### The Government Statistical Service method

We have no direct measure of the number of lifelines, the extent of exposure or the person-time at-risk of elective admission at particular 'times-since-enrolment'. But the Government Statistical Service method invites us to believe we can take analyses a step further, as though each admission represented the same number of lifelines, the same extent of exposure and the same person-time at-risk. There are only two occasions when this approach might be reasonable. In the first, the count of admissions bears a fixed relationship to the underlying period, cohort and category-specific likelihoods of admission because the waiting list is stationary.  ${}_3q_0^{\rho Rr}$  adjusts the count of admissions so that each adjusted admission in the 3-6, 6-9, 9-12 month etc waiting time categories represents the same size of population at-risk and the same conditional likelihood as an admission in the 0-3 month waiting time category.

Where we are concerned with the size and direction of changes in period and category-specific likelihoods of elective admission, official statistics describe the one truly false set of results i.e., those produced under the assumption that there has been no change. The only exception to this occurs in the second instance where patients are admitted from the waiting list at random i.e., without regard for the length of 'time-since-enrolment'. In this situation, the number of admissions from a waiting time category faithfully reflects the size of the population at-risk regardless of non-stationary recruitment and admission rates because the conditional likelihoods of elective admission are the same in each waiting time category during a specified calendar period. As a result, the bias associated with non-stationary rates of recruitment, with non-stationary rates of admission and with non-stationary category-specific conditional likelihoods of elective admission cancel out and the Government Statistical Service estimate gives the same results as  ${}_3q_0^{\rho Rr}$  and  $A_0/N_0$ .



## References

1. Department of Health. *Hospital Episode Statistics. Volume 3. Finished consultant episodes: waiting time of elective admissions by diagnosis and operation; injury/poisoning by external causes. ENGLAND: Financial year 1994-95*, Government Statistical Service, 1996.

Table 4.1: Count of the number of valid \* elective episodes generated by Trauma & Orthopaedic waiting lists in South Thames Region

BY quarter enrolled BY hospital BY financial year episode finished

Hospital	Year	1994 Q3	1994 Q2	1994 Q1	1993 Q4	1993 Q3	1993 Q2	1993 Q1	1992 Q4	1992 Q3
RA1	1997/98 †									
	1996/97 †		2	2						
	1995/96	119	27	10	3	1				
	1994/95	445	548	389	171	127	7	8	1	
	1993/94			146	202	362	363	281	142	29
	1992/93							139	274	421
	<b>Total</b>		<b>564</b>	<b>577</b>	<b>547</b>	<b>376</b>	<b>490</b>	<b>370</b>	<b>428</b>	<b>417</b>
RA2	1997/98 †	2	1		1					
	1996/97 †	10	5	3	1					
	1995/96	135	117	93	41	7	6		1	1
	1994/95	224	287	215	164	138	69	64	36	7
	1993/94			117	260	287	283	221	139	106
	1992/93							122	240	260
	<b>Total</b>		<b>371</b>	<b>410</b>	<b>428</b>	<b>467</b>	<b>432</b>	<b>358</b>	<b>407</b>	<b>416</b>
RAX	1997/98 †									
	1996/97 †	1								
	1995/96	93	23	1						
	1994/95	290	339	258	137	75	26		1	
	1993/94			61	160	220	244	224	118	42
	1992/93							81	167	264
	<b>Total</b>		<b>384</b>	<b>362</b>	<b>320</b>	<b>297</b>	<b>295</b>	<b>270</b>	<b>305</b>	<b>286</b>
RAZ	1997/98 †			1		1		1		
	1996/97 †	1	2	2	3	3	1			
	1995/96	110	68	14	5	5	3	4	3	
	1994/95	302	373	327	160	148	75	14	4	6
	1993/94			105	255	345	428	328	188	156
	1992/93							109	236	288
	<b>Total</b>		<b>413</b>	<b>443</b>	<b>449</b>	<b>423</b>	<b>502</b>	<b>507</b>	<b>456</b>	<b>431</b>

Contd 4.1: Count of the number of valid \* elective episodes generated by Trauma & Orthopaedic waiting lists in South Thames Region

BY quarter enrolled BY hospital BY financial year episode finished

Hospital	Year	1994 Q3	1994 Q2	1994 Q1	1993 Q4	1993 Q3	1993 Q2	1993 Q1	1992 Q4	1992 Q3
RCY	1997/98 †				1					
	1996/97 †	5								
	1995/96	106	77	44	16	1				
	1994/95	136	203	184	158	59	6		1	
	1993/94			46	71	79	16	4		
	1992/93							43	158	229
	<b>Total</b>		<b>247</b>	<b>280</b>	<b>274</b>	<b>246</b>	<b>139</b>	<b>22</b>	<b>47</b>	<b>159</b>
RDL	1997/98 †				1				1	
	1996/97 †	8	1		1					
	1995/96	148	112	82	41	17	3	1	5	1
	1994/95	368	392	302	209	159	97	51	39	10
	1993/94			154	280	352	425	296	200	156
	1992/93							163	278	371
	<b>Total</b>		<b>524</b>	<b>505</b>	<b>538</b>	<b>532</b>	<b>528</b>	<b>525</b>	<b>511</b>	<b>523</b>
RDM	1997/98 †									
	1996/97 †	1								
	1995/96	183	112	73	25					
	1994/95	334	372	283	164	140	115	81	45	1
	1993/94			101	246	302	270	224	156	136
	1992/93							81	170	212
	<b>Total</b>		<b>518</b>	<b>484</b>	<b>457</b>	<b>435</b>	<b>442</b>	<b>385</b>	<b>386</b>	<b>371</b>
RDR	1997/98 †									
	1996/97 †									
	1995/96									
	1994/95	8	6	16	9	7	7	1	2	
	1993/94			6	3	11	5	8	6	6
	1992/93								2	7
	<b>Total</b>		<b>8</b>	<b>6</b>	<b>22</b>	<b>12</b>	<b>18</b>	<b>12</b>	<b>9</b>	<b>10</b>

Contd 4.1: Count of the number of valid \* elective episodes generated by Trauma & Orthopaedic waiting lists in South Thames Region

BY quarter enrolled BY hospital BY financial year episode finished

Hospital	Year	1994 Q3	1994 Q2	1994 Q1	1993 Q4	1993 Q3	1993 Q2	1993 Q1	1992 Q4	1992 Q3
RDU	1997/98 †	2	1		1				1	
	1996/97 †	7	9	4	4	2	2			
	1995/96	134	131	51	26	9	5	4	2	1
	1994/95	261	357	274	182	119	105	47	39	4
	1993/94			130	236	183	219	205	194	98
	1992/93							83	145	176
	<b>Total</b>		404	498	459	449	313	331	339	381
RDV	1997/98 †									
	1996/97 †		2							
	1995/96	155	106	67	34	3	3	2	1	
	1994/95	272	311	298	213	143	112	42	6	
	1993/94			59	196	226	271	269	247	112
	1992/93							45	191	344
	<b>Total</b>		427	419	424	443	372	386	358	445
RG1	1997/98 †									
	1996/97 †									
	1995/96	55	44	13	3					
	1994/95	263	247	147	87	58	33	24	8	
	1993/94			54	124	219	234	179	79	36
	1992/93 ‡									
	<b>Total</b>		318	291	214	214	277	267	203	87
RG2	1997/98 †					2				
	1996/97 †									
	1995/96	63	41	26	10	6	1			
	1994/95	234	260	243	132	114	56	36	33	10
	1993/94			67	134	253	319	212	101	75
	1992/93 ‡									
	<b>Total</b>		297	301	336	276	375	376	248	134

Contd 4.1: Count of the number of valid \* elective episodes generated by Trauma & Orthopaedic waiting lists in South Thames Region

BY quarter enrolled BY hospital BY financial year episode finished

Hospital	Year	1994 Q3	1994 Q2	1994 Q1	1993 Q4	1993 Q3	1993 Q2	1993 Q1	1992 Q4	1992 Q3
RG3	1997/98 †	3	1							
	1996/97 †	10	12	12	8	4	1			1
	1995/96	127	90	89	55	14	9	8	4	1
	1994/95	376	306	273	213	217	141	79	22	10
	1993/94			107	189	251	355	281	252	173
	1992/93 ‡									
	<b>Total</b>	<b>516</b>	<b>409</b>	<b>481</b>	<b>465</b>	<b>486</b>	<b>506</b>	<b>368</b>	<b>278</b>	<b>185</b>
RGU	1997/98 †									
	1996/97 †									
	1995/96	114	76	38	15	1	1			1
	1994/95	244	249	147	86	81	52	41	19	8
	1993/94			82	123	154	213	176	87	88
	1992/93 ‡									
	<b>Total</b>	<b>358</b>	<b>325</b>	<b>267</b>	<b>224</b>	<b>236</b>	<b>266</b>	<b>217</b>	<b>106</b>	<b>97</b>
RGV	1997/98 †									
	1996/97 †									
	1995/96	46	24	3						
	1994/95	225	238	235	91	59	26	11	1	1
	1993/94			46	149	183	183	165	118	99
	1992/93 ‡									
	<b>Total</b>	<b>271</b>	<b>262</b>	<b>284</b>	<b>240</b>	<b>242</b>	<b>209</b>	<b>176</b>	<b>119</b>	<b>100</b>
RGW	1997/98 †									
	1996/97 †									
	1995/96	44	31	36	5					
	1994/95	130	153	135	43	72	51	8	9	1
	1993/94			50	90	140	139	98	56	39
	1992/93 ‡									
	<b>Total</b>	<b>174</b>	<b>184</b>	<b>221</b>	<b>138</b>	<b>212</b>	<b>190</b>	<b>106</b>	<b>65</b>	<b>40</b>

Contd 4.1: Count of the number of valid \* elective episodes generated by Trauma & Orthopaedic waiting lists in South Thames Region

BY quarter enrolled BY hospital episode finished

Hospital	Year	1994 Q3	1994 Q2	1994 Q1	1993 Q4	1993 Q3	1993 Q2	1993 Q1	1992 Q4	1992 Q3
RGX	1997/98 †									
	1996/97 †									
	1995/96	10	1							
	1994/95	65	95	64	32	3				
	1993/94			36	58	79	94	61	35	14
	1992/93 ‡									
	<b>Total</b>	<b>75</b>	<b>96</b>	<b>100</b>	<b>90</b>	<b>82</b>	<b>94</b>	<b>61</b>	<b>35</b>	<b>14</b>
RGZ	1997/98 †									
	1996/97 †	2								
	1995/96	69	54	35	24	3				
	1994/95	281	300	171	74	60	41	27	5	
	1993/94			109	255	278	276	164	88	52
	1992/93 ‡									
	<b>Total</b>	<b>352</b>	<b>354</b>	<b>315</b>	<b>353</b>	<b>341</b>	<b>317</b>	<b>191</b>	<b>93</b>	<b>52</b>
RHE	1997/98 †		1	1						
	1996/97 †	4	2	1	1	2	1			1
	1995/96	107	70	47	29	15	4	2	2	1
	1994/95	80	131	131	126	130	85	43	24	18
	1993/94			24	42	59	102	104	108	85
	1992/93 ‡									
	<b>Total</b>	<b>191</b>	<b>204</b>	<b>204</b>	<b>198</b>	<b>206</b>	<b>192</b>	<b>149</b>	<b>134</b>	<b>105</b>
RHG	1997/98 †‡									
	1996/97 †									
	1995/96	30	6	1	1					
	1994/95	179	207	126	42	15	11	3	1	1
	1993/94			76	142	179	197	119	39	40
	1992/93 ‡									
	<b>Total</b>	<b>209</b>	<b>213</b>	<b>203</b>	<b>185</b>	<b>194</b>	<b>208</b>	<b>122</b>	<b>40</b>	<b>41</b>

Contd 4.1: Count of the number of valid \* elective episodes generated by Trauma & Orthopaedic waiting lists in South Thames Region

BY quarter enrolled BY hospital BY financial year episode finished

Hospital	Year	1994 Q3	1994 Q2	1994 Q1	1993 Q4	1993 Q3	1993 Q2	1993 Q1	1992 Q4	1992 Q3
RHH	1997/98 †	1		3				2	1	1
	1996/97 †	4	2	3		1	3		1	1
	1995/96	98	74	30	22	4	2	5	1	2
	1994/95	215	252	279	152	103	84	47	11	6
	1993/94			69	170	240	247	265	169	90
	1992/93 ‡									
	<b>Total</b>	<b>318</b>	<b>328</b>	<b>384</b>	<b>344</b>	<b>348</b>	<b>336</b>	<b>319</b>	<b>183</b>	<b>100</b>
RJ1	1997/98 †		1							
	1996/97 †	5	4	2	2	1		1		1
	1995/96	151	126	71	32	7	4	4		
	1994/95	300	312	315	180	127	95	85	48	6
	1993/94			151	248	400	399	308	157	144
	1992/93							1		
	<b>Total</b>	<b>456</b>	<b>443</b>	<b>539</b>	<b>462</b>	<b>535</b>	<b>498</b>	<b>399</b>	<b>205</b>	<b>151</b>
RJ2	1997/98 †									
	1996/97 †		1	1						
	1995/96	67	39	38	8	2	3	2		
	1994/95	238	302	178	154	109	50	39	13	6
	1993/94			95	195	198	260	179	92	60
	1992/93 ‡									
	<b>Total</b>	<b>305</b>	<b>342</b>	<b>312</b>	<b>357</b>	<b>309</b>	<b>313</b>	<b>220</b>	<b>105</b>	<b>66</b>
RJ6	1997/98 †	1	1	1						
	1996/97 †	4	2			1				
	1995/96	103	55	28	6	3	2		1	
	1994/95	416	396	340	177	162	81	48	9	10
	1993/94			100	214	334	310	365	217	152
	1992/93 ‡									
	<b>Total</b>	<b>524</b>	<b>454</b>	<b>469</b>	<b>397</b>	<b>500</b>	<b>393</b>	<b>413</b>	<b>227</b>	<b>162</b>

Contd 4.1: Count of the number of valid \* elective episodes generated by Trauma & Orthopaedic waiting lists in South Thames Region

BY quarter enrolled BY hospital BY financial year episode finished

Hospital	Year	1994 Q3	1994 Q2	1994 Q1	1993 Q4	1993 Q3	1993 Q2	1993 Q1	1992 Q4	1992 Q3
RJ7	1997/98 †									
	1996/97 †	2		2		1	1			
	1995/96	54	27	6		1	1			
	1994/95	245	294	203	70	21	37	15	4	6
	1993/94			89	159	88	153	148	55	25
	1992/93 ‡									
	<b>Total</b>	<b>301</b>	<b>321</b>	<b>300</b>	<b>229</b>	<b>111</b>	<b>192</b>	<b>163</b>	<b>59</b>	<b>31</b>
RJZ	1997/98 †									
	1996/97 †									
	1995/96	98	64	33	18					
	1994/95	191	203	209	134	83	70	54	32	5
	1993/94			60	106	130	153	185	137	127
	1992/93 ‡									
	<b>Total</b>	<b>289</b>	<b>267</b>	<b>302</b>	<b>258</b>	<b>213</b>	<b>223</b>	<b>239</b>	<b>169</b>	<b>132</b>
RN7	1997/98 †	1								
	1996/97 †	5	4	1						
	1995/96	174	107	44	12	5	1			
	1994/95	270	336	302	208	129	42	14	4	3
	1993/94 ‡									
	1992/93 ‡									
	<b>Total</b>	<b>450</b>	<b>447</b>	<b>347</b>	<b>220</b>	<b>134</b>	<b>43</b>	<b>14</b>	<b>4</b>	<b>3</b>
RPA	1997/98 †					1				
	1996/97 †		2							
	1995/96	111	59	41	38	8	3	2	3	
	1994/95	378	434	313	131	121	86	38	3	2
	1993/94 ‡									
	1992/93 ‡									
	<b>Total</b>	<b>489</b>	<b>495</b>	<b>354</b>	<b>169</b>	<b>130</b>	<b>89</b>	<b>40</b>	<b>6</b>	<b>2</b>



Contd 4.1: Count of the number of valid \* elective episodes generated by Trauma & Orthopaedic waiting lists in South Thames Region

BY quarter enrolled BY hospital BY financial year episode finished

Hospital	Year	1994 Q3	1994 Q2	1994 Q1	1993 Q4	1993 Q3	1993 Q2	1993 Q1	1992 Q4	1992 Q3
RPC	1997/98 †									
	1996/97 †									
	1995/96	1								
	1994/95	33	22	13	5	7	3	1	1	
	1993/94 ‡									
	1992/93 ‡									
	<b>Total</b>	<b>34</b>	<b>22</b>	<b>13</b>	<b>5</b>	<b>7</b>	<b>3</b>	<b>1</b>	<b>1</b>	<b>0</b>
RPD	1997/98 †									
	1996/97 †									
	1995/96	117	58	51	13	1				
	1994/95	246	258	261	170	112	64	66	23	
	1993/94 ‡									
	1992/93 ‡									
	<b>Total</b>	<b>363</b>	<b>316</b>	<b>312</b>	<b>183</b>	<b>113</b>	<b>64</b>	<b>66</b>	<b>23</b>	<b>0</b>
RPF	1997/98 †									
	1996/97 †	7	3	4	1					
	1995/96	219	139	97	12	17	4	2	4	
	1994/95	537	564	438	267	187	106	41	16	7
	1993/94 ‡									
	1992/93 ‡									
	<b>Total</b>	<b>763</b>	<b>706</b>	<b>539</b>	<b>280</b>	<b>204</b>	<b>110</b>	<b>43</b>	<b>20</b>	<b>7</b>
RPL	1997/98 †									
	1996/97 †	7	3	2	3	3	1	2		
	1995/96	195	118	57	18	10	4	2	1	1
	1994/95	350	409	333	255	166	93	61	35	11
	1993/94 ‡									
	1992/93 ‡									
	<b>Total</b>	<b>552</b>	<b>530</b>	<b>392</b>	<b>276</b>	<b>179</b>	<b>98</b>	<b>65</b>	<b>36</b>	<b>12</b>

Contd 4.1: Count of the number of valid \* elective episodes generated by Trauma & Orthopaedic waiting lists in South Thames Region

BY quarter enrolled BY hospital BY financial year episode finished

Hospital	Year	1994 Q3	1994 Q2	1994 Q1	1993 Q4	1993 Q3	1993 Q2	1993 Q1	1992 Q4	1992 Q3
RPR	1997/98 †	1	1							
	1996/97 †	3	1	2	1					
	1995/96	184	157	120	85	15	2	2		1
	1994/95	124	185	150	148	227	119	68	25	7
	1993/94 ‡									
	1992/93 ‡									
	<b>Total</b>	<b>312</b>	<b>344</b>	<b>272</b>	<b>234</b>	<b>242</b>	<b>121</b>	<b>70</b>	<b>25</b>	<b>8</b>
RPS	1997/98 †	1								
	1996/97 †	1	1			1		1		
	1995/96	102	70	42	17	3		2		
	1994/95	186	297	215	136	77	32	18	7	2
	1993/94 ‡									
	1992/93 ‡									
	<b>Total</b>	<b>290</b>	<b>368</b>	<b>257</b>	<b>153</b>	<b>81</b>	<b>32</b>	<b>21</b>	<b>7</b>	<b>2</b>

\* Episodes where the date of enrolment was neither blank nor set to '15 Oct 1582'

† *Hospital Episode Statistics* for 1996/97 and 1997/98 were still provisional at the time the extracts were supplied.

‡ *Hospital Episode Statistics* did not capture any valid elective episodes for Trauma & Orthopaedic Surgery at this hospital this year.

Table 4.2: Estimating the period-specific conditional likelihood of admission within three months among those 'admitted' electively Trauma & Orthopaedics at St. Helier's NHS Hospital Trust (RAZ)

Completed waiting time ('quarters')	$A_x$	$\frac{S_{00}}{S_{01}}$	$\frac{S_{10}}{S_{11}}$	$\frac{S_{20}}{S_{21}}$	$\frac{S_{30}}{S_{31}}$	$\frac{S_{40}}{S_{41}}$	$\frac{S_{50}}{S_{51}}$	$\frac{S_{60}}{S_{61}}$	$\frac{S_{70}}{S_{71}}$	$\frac{S_{80}}{S_{81}}$	$\frac{S_{90}}{S_{91}}$	$\frac{S_{100}}{S_{101}}$	(3)x(4)x(5)x(6)x(7)x(8)x(9)x(10)x(11)x(12)x(13)	$A_x \times (14)$	${}_3q_0^{pRr}$
	(2)	(3)	(4)	(5)	(6)	(7)	(8)	(9)	(10)	(11)	(12)	(13)			
0	207												1.0000	207.00	0.5012
1	101	206/233											0.8841	89.30	
2	68	206/233	132/141										0.8277	56.28	
3	39	206/233	132/141	73/82									0.7368	28.74	
4	44	206/233	132/141	73/82	43/75								0.4225	18.59	
5	19	206/233	132/141	73/82	43/75	31/29							0.4516	8.58	
6	4	206/233	132/141	73/82	43/75	31/29	10/12						0.3763	1.51	
7	1	206/233	132/141	73/82	43/75	31/29	10/12	8/4					0.7527	0.75	
8	1	206/233	132/141	73/82	43/75	31/29	10/12	8/4	3/1				2.2580	2.26	
9	0	206/233	132/141	73/82	43/75	31/29	10/12	8/4	3/1	0/3			0.0000	0.00	
10	1	206/233	132/141	73/82	43/75	31/29	10/12	8/4	3/1	0/3	3/116		0.0000	0.00	
11	2	206/233	132/141	73/82	43/75	31/29	10/12	8/4	3/1	0/3	3/116	115/211	0.0000	0.00	
Totals	487													413.00	

Table 4.3: Three estimates of the cumulative likelihood of admission among those 'admitted' electively from Trauma & Orthopaedic waiting lists in South Thames Region BY hospital

Hospital	${}_3q_0^{admissions}$	${}_3q_0^{pRr}$	${}_3q_0^{admissions} - {}_3q_0^{pRr}$	$N_0$	$A_0/N_0$	${}_3q_0^{admissions} - A_0/N_0$
RA1	0.4194	0.4149	+0.0045	564	0.4149	+0.0045
RA2	0.3706	0.3925	-0.0219	371	0.3935	-0.0230
RAX	0.4826	0.5052	-0.0226	384	0.5052	-0.0226
RAZ	0.4251	0.5012	-0.0762	413	0.5012	-0.0762
RCY	0.4678	0.4573	+0.0105	247	0.4413	+0.0265
RDL	0.5251	0.5199	+0.0052	524	0.5191	+0.0060
RDM	0.4044	0.3880	+0.0164	518	0.3880	+0.0164
RDR	0.2500	0.4078	-0.1578	8	0.3750	-0.1250
RDU	0.4909	0.4770	+0.0139	404	0.4678	+0.0231
RDV	0.3666	0.3469	+0.0196	427	0.3443	+0.0223
RG1	0.5294	0.5094	+0.0200	318	0.5094	+0.0200
RG2	0.3851	0.4343	-0.0493	297	0.4343	-0.0493
RG3	0.4534	0.5090	-0.0555	516	0.5000	-0.0466
RGU	0.5313	0.4972	+0.0341	358	0.4972	+0.0341
RGV	0.5154	0.5587	-0.0434	271	0.5572	-0.0418
RGW	0.4852	0.4920	-0.0068	174	0.4713	+0.0139
RGX	0.4805	0.4933	-0.0128	75	0.4933	-0.0128
RGZ	0.6781	0.6165	+0.0616	352	0.6165	+0.0616
RHE	0.2247	0.2700	-0.0454	191	0.2670	-0.0423
RHG	0.6202	0.6172	+0.0030	209	0.6172	+0.0030
RHH	0.3684	0.4182	-0.0498	318	0.4182	-0.0498
RJ1	0.4622	0.4693	-0.0071	456	0.4693	-0.0071
RJ2	0.4032	0.4098	-0.0066	305	0.4098	-0.0066
RJ6	0.4604	0.4653	-0.0049	524	0.4656	-0.0053
RJ7	0.5302	0.5249	+0.0053	301	0.5249	+0.0053
RJZ	0.3616	0.3841	-0.0225	289	0.3841	-0.0225
RN7	0.3818	0.3267	+0.0552	450	0.3267	+0.0552
RPA	0.5495	0.5028	+0.0467	489	0.4990	+0.0506
RPC	0.8125	0.9192	-0.1067	34	0.7647	+0.0478
RPD	0.4566	0.4353	+0.0214	363	0.4353	+0.0214
RPF	0.4810	0.4646	+0.0164	763	0.4640	+0.0170
RPL	0.4077	0.4042	+0.0035	552	0.4040	+0.0037
RPR	0.2303	0.2524	-0.0221	312	0.2532	-0.0229
RPS	0.3699	0.4079	-0.0380	290	0.4069	-0.0370

Table 4.4: Two estimates of the cumulative likelihood of admission within three months among those 'admitted' electively for Trauma & Orthopaedic surgery at St. Helier's NHS Hospital Trust (RAZ) BY quarter of enrolment

Hospital	Estimate	1994 Q3	1994 Q2	1994 Q1	1993 Q4	1993 Q3	1993 Q2	1993 Q1	1992 Q4	1992 Q3
RAZ	$A_0 / \sum A_x$	0.4251	0.4506	0.4091	0.5191	0.4089	0.4889	0.4182	0.4406	0.4732
	$A_0 / N_0$	0.5012	0.4740	0.4009	0.4823	0.4382	0.4793	0.4430	0.4478	0.4711

**First steps in analysing NHS waiting times: avoiding the 'stationary and closed population' fallacy**

**Summary**

Aim

To demonstrate the effect of excluding incomplete observations and competing events when calculating cross-sectional measures of NHS waiting times. To obtain a more accurate estimate of the 'time-to-admission' of those listed on NHS waiting lists using lifetable methods.

Method

The official 'times-since-enrolment' of all elective 'admissions' in England, 1 July to 31 December 1994 inclusive, were extracted from *Hospital Episode Statistics*. The official 'times-to-census' of all those on a waiting list in England at 30 September 1994 were obtained from aggregated KH07 data. The percentage waiting at least three months, at least six months etc., was calculated separately for each dataset and compared with a period lifetable derived from the combined data.

Results

The cumulative likelihood of elective admission is markedly overestimated across the whole range of waiting times. The experience of those still waiting, those removed from the list, those suspended or deferred and those put to the back of the queue is not taken into account in the calculation of official waiting times.

Conclusions

The Department of Health currently presents the 'time-since-enrolment' of those admitted as though it indicates how long all patients can expect to wait for admission. The consequent bias in published summary statistics incorrectly quantifies the real experience of patients. It is recommended that calculation of waiting times from KH07 census counts and *Hospital Episode Statistics* be reconsidered in the light of what patients, clinicians, managers and politicians need to know about treatment delay.

**Introduction**

Background

In October 1993, "*Professor Turnberg said that more than half of the patients on routine waiting lists should be classed as urgent and seen within six weeks*" while the Department of Health spokesperson insisted that "*... half of all patients on waiting lists are already seen in five weeks ...*"<sup>1</sup>.

Now if half those still waiting should be classed as urgent and if urgent patients are actually given priority then more than half those enrolled on the waiting list must originally have been thought to require urgent admission. And, in retrospect, an even greater proportion of those already admitted may well turn out to have been urgent cases because the longer people have to wait for admission, the less likely they are ever to

be admitted. The relationship between those admitted, those censused and those enrolled is poorly understood by those debating the state of NHS waiting lists.

Government statistics compound the problem by reporting two different sets of waiting times. The 'times-since-enrolment' of those still waiting at a particular date <sup>2</sup> and the 'times-since-enrolment' of those 'admitted' electively <sup>3</sup> over a specified calendar period provide two different cross-sections of the English waiting list. Yet published summary measures use each set of data as if it represented a group of patients enrolled together and followed up until all had been admitted. As a result, we know neither how long people wait nor whether those who wait longest are best able to do so.

### Objectives

This chapter uses cross-sectional data to construct a lifetable estimate of the cumulative likelihood of admission among those at-risk of elective admission from English waiting lists between 1 July and 31 December 1994 inclusive. It illustrates the extent to which government statistics underestimate the 'time-to-admission' of those listed.

### **Materials and Methods**

#### The data available

*Hospital Waiting List Statistics: England at 30 September 1994* <sup>2</sup> were compiled using the KH06 <sup>4</sup> and KH07 <sup>4</sup> forms for ordinary and day case waiting lists in England which were submitted by 6 October 1994. The KH07 return counts the number of people still at-risk of elective admission in each three month waiting time category. This census excludes all those not at-risk of elective admission at the time it is taken i.e., those who had been admitted or removed and those who were temporarily suspended, deferred on medical grounds or already in hospital for something else <sup>2</sup> at the time of the census.

The KH06 and KH07A <sup>4</sup> returns together describe patient flows on and off the waiting list. The KH06 records the number of new 'decisions-to-admit' to the waiting list during the last three months as well as the numbers removed, suspended or admitted. The KH07A reports the number of patients whose accumulated time on the list ended in self-deferral or in a failure to attend and who were penalised by being put to the back of the queue as though newly recruited on the date they should otherwise have been admitted. Unfortunately, we do not know how many patients were 'reset-to-zero' in this fashion nor do we know the number 'reinstated' following medical deferral or administrative suspension each quarter nor do we know the waiting times of those whose experience of the waiting list ended in elective admission or some competing event.

The Government Statistical Service has been content with estimating patient waiting times from *Hospital Episode Statistics* <sup>3</sup> or KH07 returns. And it doesn't need any of this 'missing' data to assess patient compliance or the validity of the waiting list census. But we want to estimate the size of the population at-risk of elective admission within each waiting time category in order to calculate the proportion of those at-risk who were admitted i.e., the conditional likelihoods of elective admission. So we adopt a number of

simplifying assumptions which fill the gaps in our knowledge of waiting lists and allow construction of a period lifetable.

### The approximations required

#### *Waiting times ending in an elective admission*

*Hospital Episode Statistics*<sup>3</sup> collates electronic extracts of inpatient and day case episodes from the Patient Administration System. It includes the experience of private patients and others who were treated electively in NHS hospitals in England regardless of whether they appeared in *Hospital Waiting List Statistics: England at 30 September 1994*<sup>2</sup>. It reports 1.21 valid elective episodes for each elective admission documented in the aggregate KH06 returns between 1 July and 31 December 1994 inclusive. *Hospital Episode Statistics* defines 'time-since-enrolment' as the interval between the date of 'admission' and the date of enrolment whereas the KH07 return defines 'time-since-enrolment' as the interval between the date of the census and the date of enrolment or the date when the patient was last 'put-to-the-back-of-the-queue'. Clearly, the 'times-since-enrolment' obtained from valid elective episodes do not reflect the practice of putting patients to the back of the queue. As a result, we would expect them to be longer than would have been the case had the KH07 waiting time definitions applied. Nevertheless, we shall assume that the distribution of valid elective episodes by quarter of enrolment, three-month waiting time category and quarter of 'admission' is the same as the unknown distribution of KH06 admissions.

Electronic records with valid dates of enrolment were cross-tabulated by quarter of enrolment, three-month waiting time category and quarter of 'admission'. The counts for the quarter ending 30 September were divided by 1.21 i.e., the ratio of valid elective episodes (1,007,103) to KH06 admissions (832,065) for the period 1 July to 30 September 1994. And the counts of valid elective episodes for the quarter ending 31 December were divided by 1.21 i.e., the ratio of valid elective episodes (1,010,582) to KH06 admissions (833,682) for the period 1 October to 31 December 1994. This provides an approximate distribution for the KH06 admissions.

#### *Waiting times ending in a competing event*

The distribution of competing events by quarter of enrolment, three-month waiting time category and quarter of admission was estimated using the following procedure:

1. The number censused in the 3-6 month waiting time category at 30 September 1994 was subtracted from the number censused in the 0-3 month waiting time category at 30 June 1994. In the same way, the number censused in the 6-9 month waiting time category at 30 September 1994 was subtracted from the number censused in the 3-6 month waiting time category at 30 June 1994, and so on. For each enrolment cohort, this gives the number of waiting times that must have ended in admission or a competing event at some point between the two censuses.
2. Each intercensal difference was adjusted by subtracting the numbers 'known' to have been admitted during the 92 day intercensal period, leaving a remainder who must have experienced a competing event instead.
3. Each enrolment cohort traversed two waiting time categories between 30 June and 30 September. 'Competing events' were imputed to these categories in the same proportion as 'admissions'.



4. The number censused in the 0-3 month waiting time category on 30 September has to be subtracted from the number enrolled in the previous quarter i.e., the number listed with a waiting time of zero days at any point between midnight 30 June and midnight 30 September 1994. (This was estimated as the number of new 'decisions-to-admit' plus the number reported as self-deferring or failing to attend that quarter.) This difference was adjusted to allow for the number 'known' to have been admitted, leaving the number of competing events preceding the first census of this cohort.

These steps were repeated for the quarter of admission which ended at midnight 31 December 1994.

#### Four alternative measures?

The number of elective 'admissions' falling in each waiting time category was calculated as a proportion of all elective 'admissions' <sup>5</sup> between 1 July and 31 December 1994 inclusive ( ${}_n q_x^{admissions}$ ). ( $n$  represents the length of the waiting time category and is normally three months,  $x$  represents the start of the waiting time category e.g., 0 months, 3 months, 6 months etc., and the *admissions* superscript reminds us that we are using the method based solely on elective 'admissions'.) The complementary proportion with longer 'times-since-enrolment' was also calculated for each waiting time category ( ${}_n p_x^{admissions} = 1 - {}_n q_x^{admissions}$ ). Finally, the cumulative proportion with longer 'times-since-enrolment' was calculated as the product of the  ${}_n p_x^{admissions}$  values for all the categories preceding the waiting time of interest. The cumulative proportion of those with longer 'times-since-enrolment' describes the 'time-since-enrolment' of those admitted.

In a similar fashion, the number censused in each waiting time category was calculated as a proportion of all those still at-risk of admission <sup>5</sup> on 30 September 1994 ( ${}_n q_x^{census}$ ). (The *census* superscript reminds us that we are using the method based solely on census counts.) The complementary proportion with longer 'times-to-census' was also calculated for each waiting time category ( ${}_n p_x^{census} = 1 - {}_n q_x^{census}$ ). Finally, the cumulative proportion with longer 'times-since-enrolment' was calculated as the product of the  ${}_n p_x^{census}$  values for all the categories preceding the waiting time of interest. The cumulative proportion of those with longer 'times-since-enrolment' describes the 'time-to-census' of those censused.

Thirdly, the likelihood of admission from each waiting time category was calculated using formula 2.3 <sup>6</sup>

$${}_n q_x^{upper} = \frac{{}_n A_x^+ + {}_n A_x^-}{{}_n A_x^+ + {}_n P_x + {}_n C_x^+} \text{ where } {}_n P_x \text{ represents the number still at-risk of admission from the category}$$

at the time of the census,  ${}_n A_x^+$  and  ${}_n A_x^-$  represent the numbers admitted from the category before and after the census respectively and  ${}_n C_x^+$  represents all those whose experience of the waiting list ended when they were removed, reset to zero, deferred or suspended from the list before the census. The complementary probability of not having been admitted was also calculated for each waiting time category ( ${}_n p_x^{upper} = 1 - {}_n q_x^{upper}$ ). Finally, the cumulative probability of not having been admitted was calculated as the product of  ${}_n p_x^{upper}$  for all the categories preceding the waiting time of interest. This cumulative probability of not having been admitted describes the upper limit of the 'time-to-admission' of those listed.

Fourthly, a lower estimate of the cumulative probability of not having been admitted was calculated using

formula 2.4 <sup>6</sup>  ${}_n q_x^{lower} = \frac{{}_n A_x^+ + {}_n A_x^-}{{}_n A_x^+ + {}_n P_x - {}_n C_x^-}$  and describes the lower limit of the 'time-to-admission' of those

listed.

## Results

### The KH06, KH07A and KH07 returns

Patients appear in table 5.1 if they were at-risk of admission from the English waiting list at any point between midnight 30 June and midnight 31 December. The table describes the same group of patients on two different classifications, comparing their status on entering the group at-risk of admission (E) with their status on leaving (L). The number of patients waiting at the start of a calendar period of interest or who counted as new 'decisions-to-admit' or as those 'reset-to-zero' or 'reinstated' during it, must be reconciled with the numbers admitted, removed, self-deferred, failed, medically deferred or suspended during the calendar period of interest or still awaiting admission at its close. As a result, the internal consistency of this table should be 100% and the 'error of closure' <sup>7</sup> should be 0%.

Table 5.1 shows that the data collected still only gives an incomplete picture of the English waiting list. There is no information on the numbers medically deferred or on the numbers 'reinstated' following medical deferral or suspension from the list and there is no count of the numbers 'reset-to-zero' each quarter. In this instance, the number self-deferring or failing to attend will only overestimate the number 'reset-to-zero' that quarter if patients normally give three or more months notice of their intention to defer admission.

Table 5.1 shows a small, regular excess of elective admissions and censored observations over the number at-risk during the calendar period of interest. Although this 'error of closure' is modest and never exceeds 2.3%, it does not compare favourably with values reported for the population of Great Britain <sup>8</sup>. A number of explanations can be suggested for this systematic discrepancy.

- The KH06, KH07A and KH07 returns for the quarter ending Friday, 30 September 1994, were supposed to reach the Government Statistical Service on Thursday, 6 October 1994 <sup>2</sup>. If four days' records had not been entered on the Patient Administration System at the time the KH06 returns were completed, the number of new 'recruits' reported could have been 60,000 too few. Some of these would also be missing from the 0-3 month category of the KH07 census. Despite this, they generate admissions (and competing events) during the next quarter or appear as a count in the 3-6 month category of the census on 31 December 1994. If this surmise were correct, the census count ( ${}_3 P_0$ ) in the 0-3 month category of table 5.2 should be increased along with our estimates of the number of competing events occurring in the 0-3 month category before ( ${}_3 C_0^+$ ) and after ( ${}_3 C_0^-$ ) 30 September 1994. Unfortunately, the extent of such underenumeration cannot be estimated from the

error of closure because both ‘stock’ and ‘flow’ statistics are affected. Any such underenumeration would inflate our estimate of  ${}_3q_0^{upper}$  and  ${}_3q_0^{lower}$ .

- The count of patients removed from the waiting list may include some who have already been admitted<sup>9</sup>. This sort of double-counting will exaggerate the number of incomplete observations and competing events reported by the KH07 and KH06 returns. And as a result of steps 1-4 above, it shifts competing events from the waiting time category of the actual admission to the cohort and waiting time category of the ostensible ‘removal’. The size of any overenumeration cannot be obtained from the error of closure because ‘stock’ and ‘flow’ statistics are affected equally. This sort of double-counting will have little effect on our estimates of  ${}_3q_0^{upper}$  and  ${}_3q_0^{lower}$  provided removal occurs in the quarter following admission.
- Some patients may be admitted so promptly that they neither count as a new ‘recruit’ nor figure in a waiting list census<sup>10</sup>. In this case, we underestimate the number of competing events prior ( ${}_3C_0^+$ ) to 30 September 1994 and inflate our estimate of  ${}_3q_0^{upper}$ .

It seems likely that the source of this ‘error of closure’ will only be established by verifying KH06, KH07A and KH07 counts against contemporary Patient Administration System records.

The number of competing events in each waiting time category is calculated from what is left of the difference between successive census counts having allowed for ‘admissions’. In other words, the excessive number reported as leaving (L) the population at-risk (table 5.1) is ascribed to over-reporting of competing events. This approach admits there will be no ‘error of closure’ when we give a complete and accurate account of what happened to the people clinicians contracted to serve. (Although the NHS is obliged to produce complete and accurate reports of how it used public monies, the same standard has yet to be applied to accounts of what became of patients enrolled on the waiting list for England.) And this approach also takes the most optimistic view of the admissions reported on the KH06 return. As a result, our estimate of  ${}_nq_x^{upper}$  will be inflated if part of the excess leaving the population at-risk ought to have been ascribed to over-reporting of KH06 admissions.

#### The calendar period lifetable

The KH06 and KH07A returns report the numbers admitted from the waiting list etc., during a particular three month period of data collection and these are represented by the ‘columns’ in figure 5.1. All those enrolled during one of these three month periods must subsequently be admitted, removed, deferred on medical or administrative grounds or be reset-to-zero and until then should (normally) appear in the census at the end of each quarter survived: these enrolment cohorts are represented by the ‘diagonals’ in figure 5.1.

Figure 5.1A cross-tabulates valid elective episodes by the quarter of their enrolment on the waiting list, by

Figure 5.1: Lexis diagrams describing imputation from KH06, KH07A and KH07 data and from valid elective episodes. (All specialties and all NHS hospitals in England)

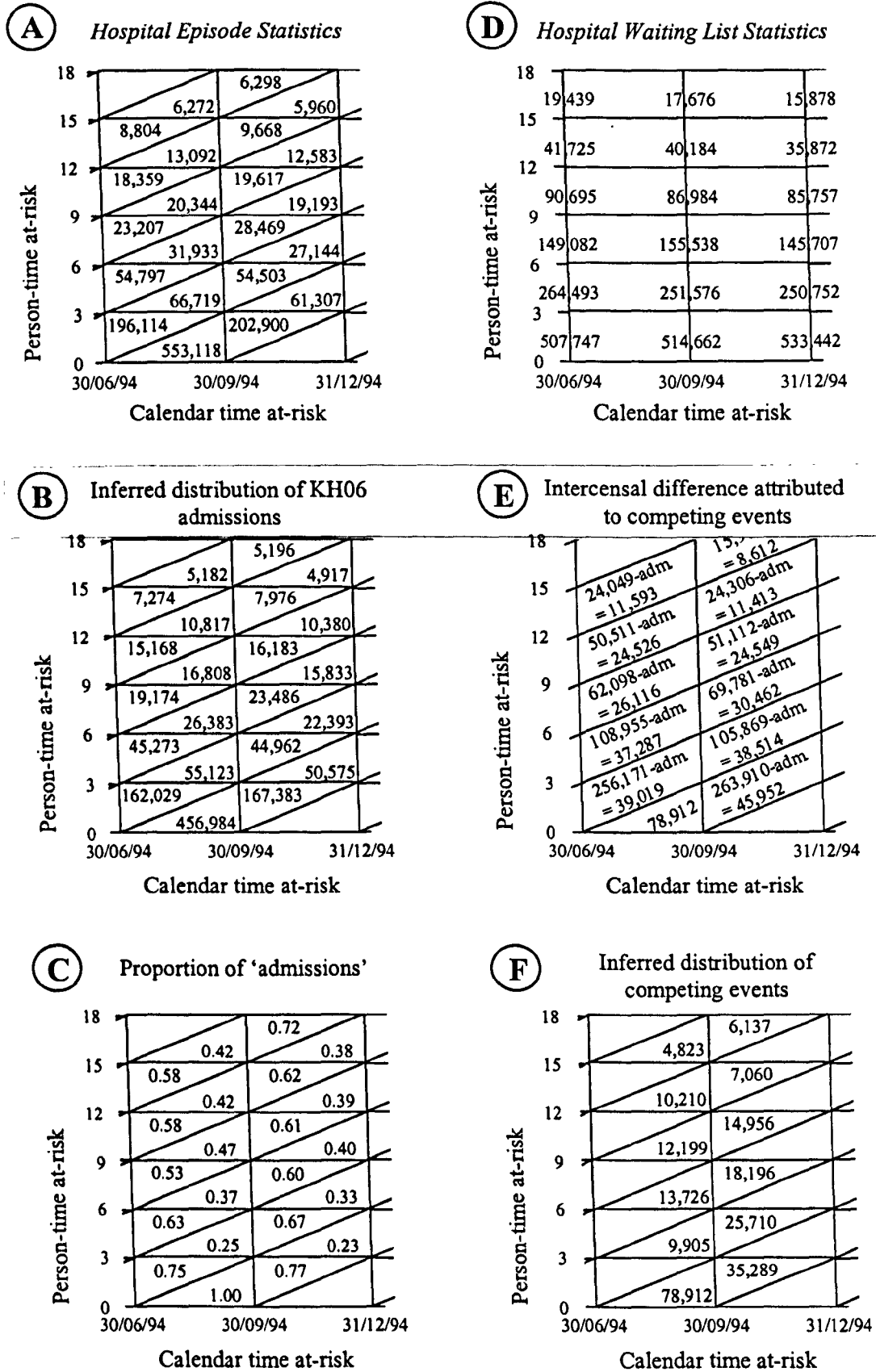

the quarter of their 'admission' from the waiting list and by the three-month waiting time category which best describes their 'time-since-enrolment'. For example, those enrolled between midnight 31 March and midnight 30 June generated 196,114 valid elective episodes in the 0-3 month waiting time category between midnight 30 June and midnight 30 September. Figure 5.1B scales these down to a level consistent with the total number of elective admissions reported to the Department of Health for the quarter using the KH06 return (832,065). As there were 1.21 valid elective episodes for each KH06 admission, we assume that those enrolled between midnight 31 March and midnight 30 June contributed  $196,114 \div 1,007,103 / 832,065 = 162,029$  KH06 admissions to the overall figure reported. Figure 5.1C shows the split of valid elective episodes (and the assumed split of KH06 admissions) between the waiting time categories traversed by an enrolment cohort during a particular quarter of admission.  $196,114 / (196,114 + 66,719) = 0.7462$  of the valid elective episodes generated by this cohort between midnight 30 June and midnight 30 September had been enrolled on the waiting list less than three months previously.

Figure 5.1D reports the numbers censused in each three-month waiting time category at the close of each quarter of admission. 507,747 of those enrolled between midnight 31 March and midnight 30 June were still eligible for elective admission on the morning of 1 July but only 251,576 of these were still waiting 92 days later at midnight 30 September 1994. Figure 5.1E shows that once we allow for  $(162,029 + 55,123) = 217,152$  KH06 admissions, we have to assume that about 39,019 waiting times must have ended in an event other than elective admission. Figure 5.1F imputes  $(1 - 0.7462)$  of these to the 3-6 month waiting time category.

Table 5.2 assembles the numbers used to calculate the conditional likelihood of elective admission from each waiting time category and table 5.3 shows the four sets of cumulative probabilities plotted on figure 5.2. The procedure used to estimate the number of competing events in each waiting time category calculates them as what is left of the difference between successive census counts having allowed for 'admissions'. But this approach cannot allow for patients 'reinstated' to the list and their subsequent exposure to the risk of elective admission. Where such patients appear in the next census, they produce a one-for-one underestimate of the number of competing events during the intercensal period. This will also be the case if reinstatement ends in a competing event before the next census. And if they are admitted before the next census, they produce a one-for-one underestimate of the actual number of competing events. The lifetable estimates presented here  $({}_n q_x^{upper}, {}_n q_x^{lower})$  overestimate the true conditional likelihoods because some patients are reinstated to the waiting list for England.

The unknown 'time-since-enrolment' of KH06 admissions should lie below and to the left of the 'time-since-enrolment' derived from valid elective episodes (figure 5.2) because of their differing approach to patients who have been put to the back of the queue. Despite delayed data entry and reinstatement of patients, the 'time-to-admission' of those listed may also begin below and to the left of the estimates plotted in figure 5.2 and will subsequently adopt a flatter course. The lifetable estimate for the population generating valid elective episodes would begin to the right and above that plotted in figure 5.2. As a result, when we come to examine a comprehensive, internally consistent set of data that documents 'times-to-

admission', 'times-to-competing-event' and 'times-to-census', we may find a larger discrepancy than suggested by figure 5.2.

Figure 5.2: Four alternative measures of the 'time-to-admission' of those listed on waiting lists in England around 30 September 1994

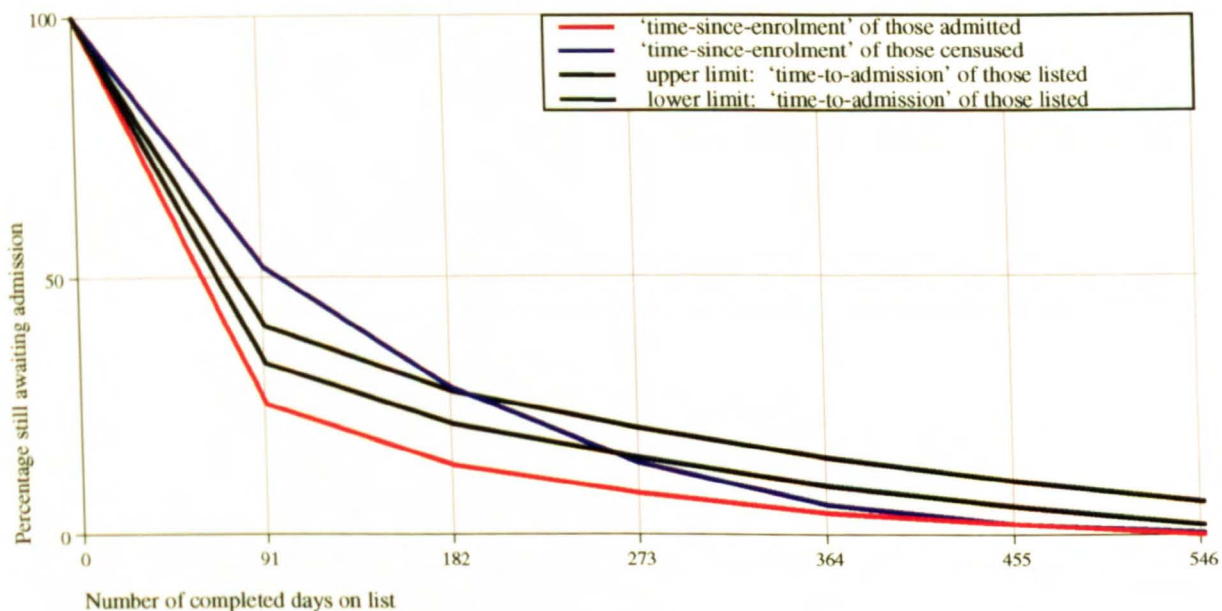

Data from the aggregated KH07 returns and from *Hospital Episode Statistics* are used interchangeably in the literature as though the group of patients censused were also responsible for generating the 'admissions' observed. The lifetable method described here makes a less demanding assumption to justify combining information from the two sets of data<sup>10</sup> i.e., that both populations share the same distribution of 'times-since-enrolment'. As a result, it is clear that the Government Statistical Service overestimates the proportion admitted within three months ( ${}_3q_0^{admissions} = 0.75$ ) even if we choose to ignore the additional contribution of competing events:

$${}_3q_0^{lower} = \frac{{}_3A_0^+ + {}_3A_0^-}{{}_3A_0^+ + {}_3P_0 - {}_3C_0^-} = \frac{456,984 + 167,383}{456,984 + 514,662 - 35,289} = 0.67,$$

$${}_3p_0^{lower} = (1 - {}_3q_0^{lower}) = 0.33.$$

But the two populations do not share a common distribution of 'times-since-enrolment'. The ratio of valid elective episodes to KH06 admissions is assumed to be 1.21 regardless of the sub-groups considered yet General Medicine generated 1.94 valid elective episodes for each KH06 admission between 1 July and 31 December 1994. These episodes have very short 'times-since-enrolment'. As a result, we might expect our values of  ${}_3q_0^{upper}$  and  ${}_3q_0^{lower}$  to be inflated because we have not reduced the contribution of valid

elective episodes from General Medicine to a level consistent with the number of KH06 admissions reported for the specialty.

## Discussion

### Are urgent patients given enough priority?

When Professor Turnberg claimed that "... *more than half of the patients on routine waiting lists should be classed as urgent and seen within six weeks ...*"<sup>1</sup>, he seemed to be referring to those still on routine waiting lists i.e., those who would be censused. The Department of Health could not query his assertion that half of the patients should be classed as urgent because the numbers of urgent and non-urgent patients still awaiting elective admission in England had not been collected since 1 April 1987<sup>11</sup>. And the information available nationally only allowed the Government Statistical Service to consider the numbers censused within three month waiting time categories. But the Conference of Medical Royal Colleges obtained its information direct from clinicians so it may have been able to determine what proportion of those censused should be classed as urgent and what proportion of those censused had 'times-since-enrolment' within six weeks.

Figure 5.2 shows that more than half the patients on the English waiting list at 30 September 1994 had already waited more than six weeks. But in 1993, the Department of Health spokesperson side-stepped the issue by directing attention to the group of patients fortunate enough to have already been admitted<sup>1</sup>. It is completely unremarkable that the 'times-since-enrolment' of those admitted are shorter than the 'times-since-enrolment' of those not i.e., those censused. Instead, the Department of Health spokesperson had to demonstrate that the 'times-since-enrolment' of those admitted were so much shorter that they guaranteed prompt admission of all those classified as urgent.

It is not generally recognised that the mix of urgency categories captured in a census is different from the mix of urgency categories captured in an admissions database. Nor is it recognised that the mix of urgency categories differs again among those enrolled together and yet again among those listed together. As a result, it was possible for Professor Turnberg and the Department of Health spokesperson to talk at cross-purposes and this remains the case today.

### How long might I expect to wait for elective admission?

It is widely recognised that the 'time-since-enrolment' of those censused provides a biased estimate of how long patients might expect to wait for elective admission. But the properties of this prevalence measure have been widely misconstrued following the lead given by Don, Lee & Goldacre in 1987<sup>12</sup>. The proportion contributed by any group destined to wait a long time will be exaggerated by a census but that does not mean that long waiting times are over-represented. If anything the census over-represents short waiting times because it includes some which are destined to end after short waiting times and others which only happen to be short at the time of the census and are destined to end after relatively long waiting times. Whereas the event-based measure allows us to talk about the proportion of completed 'times-to-admission', the census measures a quite different quantity namely the proportion of the total person-time at-risk.

However, it is not widely recognised that the event-based measure is also prone to bias (chapter 2). In fact, the method currently used by the Government Statistical Service would require special justification were it applied to cancer survival, the development of prognostic indicators or to improvements in life expectancy as a result of treatment. The period lifetable reported serves to illustrate that NHS waiting times cannot be described adequately without allowing for competing events and incomplete observations<sup>13, 14, 15</sup>. Taken separately, the ‘times-since-enrolment’ censused by the KH07 return and the ‘times-since-enrolment’ captured in the *Hospital Episode Statistics* are not representative of the ‘times-to-admission’ of those listed. As a result, official estimates of how long patients might expect to wait for admission would be misleading even if the data collected was entirely accurate and perfectly valid.

It follows that:

- Patient Administration System<sup>16</sup> tables of the ‘times-since-enrolment’ of those still awaiting treatment underestimate the full length of ‘time-to-admission’ actually experienced by these patients;
- Health Service Indicators<sup>17</sup> have misled purchasers about the absolute performance of providers;
- Patients’ Charter Performance Tables<sup>18</sup> have misled the public on the likely ‘time-to-admission’ of those listed;
- Department of Health press releases<sup>19</sup> and spokespersons<sup>1</sup> overestimate the percentage admitted within five weeks of enrolment and the volume of urgent cases comfortably accommodated within existing levels of activity.

### Information for Health

Parliament regularly debates shifts of a few percentage points in the proportion of those censused still waiting 365 days after their enrolment on the list. Given the margin of uncertainty suggested in figure 5.2, Members of Parliament need better estimates of the likelihood of elective admission among those listed.

Period lifetables do not assume that the waiting list is stationary or closed, they do not call for complete and consistent sets of historical data and they do not require a minimum length of follow-up after enrolment on the waiting list. In other words, period lifetables can provide up-to-the-minute, unbiased estimates of the prevailing cumulative likelihood of elective admission if we collect and combine three sets of cross-sectional data namely:

1. The ‘times-since-enrolment’ of all those still awaiting elective admission at the end of the calendar period of interest;
2. The ‘times-since-enrolment’ of all those admitted and treated (or investigated) electively during the period of interest and
3. The ‘times-since-enrolment’ of all whose wait for elective admission ended in some other fashion during the period of interest.

This information is already available throughout England on each separate Patient Administration System so the simplest approach would involve collecting items 1 and 3 alongside the data already captured in *Hospital Episode Statistics*. The additional data would allow construction of period lifetables for any sub-population of the waiting list we care to define using diagnostic group or procedure code and would allow replacement of the misleading summary measures issued in published volumes of *Hospital Episode*



*Statistics.* We believe this recommendation is consistent with the expressed aims of the *Information for Health strategy* <sup>20</sup>.

Unfortunately, *Hospital Episode Statistics* take several years to compile and validate so it may be useful to consider how the KH06, KH07 and KH07A returns might be amended to provide more timely information albeit without the same flexibility, exactness and accuracy. Now for our purpose, the most important deficiency of these returns is the absence of any information on 'times-to-admission' and 'times-to-competing-event'. It would be unrealistic to recommend collection of new items that increase the burden of data collection where hospitals are struggling to maintain the accuracy of central returns. But given the apparent discrepancy between the 'time-since-enrolment' of those censused and the 'time-to-admission' of those listed there seems little point attempting to distinguish between ordinary and day case waiting lists or between provider-based demand and resident-based demand <sup>21</sup>. So we recommend that the Department of Health limit central returns to a single waiting list population whether of inpatients plus day cases or just inpatients or just day cases. And we recommend that the superfluous returns be replaced by a requirement to separately report the number of admissions and competing events generated by each enrolment cohort within the waiting time category 'sectioned' by the KH07 census. This information would allow us to construct approximate period lifetables using fewer assumptions and a much simpler method than proved necessary here. And as the series accumulates, stable population theory and conditional likelihoods could be used to produce better estimates still.

### Concluding remarks

The Government Statistical Service does not calculate the conditional likelihoods of elective admission among those listed within each three-month waiting time category nor does it collect the information needed to do this. As a result, we have had to make several less than satisfactory assumptions in order to compare published estimates with those obtained from a period lifetable. With the right data, period lifetables are hardly more complicated than the method currently preferred by the Government Statistical Service and are undoubtedly less susceptible to bias. This chapter advocates collection of the right data to allow definitive assessment of the size of the discrepancy in official estimates. And it recommends that calculation of waiting times from *Hospital Episode Statistics* <sup>22</sup> and KH07 census counts <sup>23</sup> be reconsidered in the light of what patients, clinicians, managers and politicians need to know about treatment delay.

### References

1. Laurance J. 'Top doctor says NHS is failing priority patients', *The Times*, 20 October 1993, page 4.
2. Department of Health, NHSME. *Hospital Waiting List Statistics: England at 30 September 1994*, Government Statistical Service, Finance and Corporate Information Division, Branch MIAB, Leeds, 1994.

3. Department of Health. *Hospital Episode Statistics. Volume 3. Finished consultant episodes: waiting time of elective admissions by diagnosis and operation; injury/poisoning by external causes. ENGLAND: Financial year 1994-95*, Government Statistical Service, 1996.
4. Department of Health, NHS Management Executive, Information Management Group. 'Patients awaiting elective admission', In: *The data manual: module 1: hospital services. Version 1.0*, Department of Health, Stanmore, 1992. Pages 5/15-5/18.
5. Department of Health. *Statistical Bulletin. Elective admissions and patients waiting: England at 31 March 1994*, Government Statistical Service, Leeds, 1994. Page 1.
6. Kaplan EL, Meier P. 'Nonparametric estimation from incomplete observations', *American Statistical Association Journal*, 53, 457-481 (1958).
7. Newell C. 'The basic demographic equation', In: *Methods and Models in Demography*, Belhaven Press, London, 1988. Chapter 1, page 8.
8. Benjamin B. *Health and Vital Statistics*, George Allen & Unwin, London, 1968. Page 22.
9. Donaldson LJ, Maratos JI, Richardson RA. 'Review of an orthopaedic in-patient waiting list', *Health Trends*, 16, 14-15 (1984).
10. NHS Executive. *Supplement to Department of Health Statistical Bulletin 1996-1. Elective Admissions and Patients Waiting - description of the method used to estimate waiting times of patients admitted from waiting lists*, Government Statistical Service, Leeds, 1996. Page 14.
11. DHSS. *Management Services. Post Korner aggregate statistical returns. SM(86)2/12*. Statistics and Research Division, DHSS, 1986.
12. Don B, Lee A, Goldacre MJ. 'Waiting list statistics. III. Comparison of two measures of waiting times', *BMJ*, 295, 1247-1248 (1987).
13. Daly LE, Bourke GJ, McGilvray J. 'Medical Studies and Epidemiological Statistics', In: *Interpretation and Uses of Medical Statistics*, 4th Edition, Blackwell Scientific Publications, Oxford, 1992.
14. Peto R, Pike MC, Armitage P, Breslow NE, Cox DR, Howard SV, Mantel N, McPherson K, Peto J, Smith PG. 'Design and analysis of randomised clinical trials requiring prolonged observation of each patient. II. Analysis and examples', *British Journal of Cancer*, 35, 1-39 (1977). (Pages 14, 15.)

15. Moon L. *Waiting for elective surgery in Australian public hospitals 1995*, Australian Institute of Health and Welfare, Canberra, 1996. (Pages 16, 26.).
16. Shared Medical Systems Corporation. *Action UK Model In-patient Application Waiting List. Release 5.0. Application Manual*, Shared Medical Systems United Kingdom Ltd., Basingstoke, 1992.
17. NHS Executive. *Health Service Indicators Handbook 1994/95, FPA - Comparative Information & Analysis*, Department of Health, Leeds, 1996. WL44, WL92-WL94.
18. NHS Executive. *How long might you expect to wait for ... an ambulance? a hospital appointment? an operation? How do your local health services measure up to the Patient's Charter? South-Thames Summary 1996-97*, Department of Health, Leeds, 1997.
19. Department of Health. *Second Quarter Waiting Time Figures Published. Press Release 94\529*, Department of Health, 1994.
20. NHS Executive. *Information for Health. An information strategy for the modern NHS 1998-2005*. NHS Executive, 1998.
21. NHS Executive. *Changes to collection of waiting lists/times date in 1998/99. HSC 1998/152*. NHS Executive, 1998.
22. NHS Executive. *The new NHS Modern and Dependable: A national framework for assessing performance. Consultation Document*, Department of Health, 1998. Page 41.
23. NHS Executive. *The NHS Performance Assessment Framework*, Department of Health, 1999. Page 19.

Table 5.1: Internal consistency of KH06, KH07A and KH07 returns: who counts in official waiting times for England and who doesn't?  
(1 July to 31 December inclusive)

Year	Entering the group 'at-risk' of admission (E)				Error of Closure E-L (% = [E-L]/E*100)	Leaving the group 'at-risk' of admission (L)						Censused 31.12.94 [KH07]
	Censused 30.06.94 [KH07]	'Decisions- to-admit' [KH06]	'Reset-to- zero' *	'Re- instated' †		Admitted [KH06]	Removed [KH06]	Self-deferred [KH07A]	Failed [KH06]	Medic. Defrrd	Suspended [KH06]	
1998												
1997	1,207,515	‡	‡	‡	‡	‡	‡	‡	‡	-	‡	1,261,915
1996	1,056,122	2,067,520	306,572	123,383	-54,216 (-1.5%)	1,799,013	273,861	193,345	113,227	-	123,383	1,104,984
1995	1,052,958	1,972,067	288,143	92,966	-43,331 (-1.3%)	1,739,917	273,491	182,723	105,420	-	92,966	1,054,948
1994	1,077,497	1,861,754	257,577	50,008	-48,381 (-1.5%)	1,665,747	251,393	160,343	97,234	-	50,008	1,070,492
1993	1,019,341	1,731,690	225,203	-	-68,237 (-2.3%)	1,531,449	222,034	133,802	91,401	-	-	1,065,785
1992	937,054	1,748,716	204,380	-	-47,014 (-1.6%)	1,553,237	202,358	111,373	93,007	-	-	977,189
1991	964,050	1,614,328	190,474	-	-32,115 (-1.2%)	1,463,869	196,526	93,065	97,409	-	-	950,098
1990	955,786	1,485,021	210,352	-	-52,845 (-2.0%)	1,373,394	154,738	101,028	109,324	-	-	965,520
1989	922,877	1,446,243	307,945	-	-48,321 (-1.8%)	1,323,492	122,104	99,189	208,756	-	-	971,845
1988	878,306	1,389,133	298,687	-	-45,574 (-1.8%)	1,286,087	95,431	95,508	203,179	-	-	931,495

\* Estimated as the number who self-deferred or failed-to-attend for admission to hospital that quarter.

† Estimated as the number temporarily suspended or deferred on medical grounds that quarter.

‡ The quarterly counts were not collected in 1997/98.

Note: The numbers in italics contribute nothing to the difference between E and L so the 'error of closure' is really a comparison of columns 2 & 3 with columns 7, 8 & 13.

Table 5.2: Counts of those listed on the English waiting list around 30 September 1994

Completed waiting time (days)	Admissions pre-census ( ${}_n A_x^+$ )	Admissions post-census ( ${}_n A_x^-$ )	'Person-quarters' at- risk ( ${}_n P_x$ )	Competing events pre-census ( ${}_n C_x^+$ )	Competing events post-census ( ${}_n C_x^-$ )
0	456,984	167,383	514,662	78,912	35,289
92	55,123	44,962	251,576	9,905	25,710
183	26,383	23,486	155,538	13,726	18,196
273	16,808	16,183	86,984	12,199	14,956
365	10,817	7,976	40,184	10,210	7,060
457	5,182	5,196	17,676	4,823	6,137
548	2,693	1,811	2,834	3,175	- 1,491 *
Total	575,370	268,587	1,071,101		

\* This is clearly invalid so table 5.3 and figure 5.2 close with the 457-548 day waiting time category.

Table 5.3: Are there four alternative measures of the 'time-to-admission' of those listed on the waiting list in England around 30 September 1994?

Completed waiting time (days)	Chance of being admitted $({}_n q_x^{upper})$ (2.3)	Chance of not being admitted $({}_n p_x^{upper})$	Chance of being admitted $({}_n q_x^{lower})$ (2.4)	Chance of not being admitted $({}_n p_x^{lower})$	'time-to-admission' of those listed at 30.09.94 $(I_x^{upper})$	'time-to-admission' of those listed at 30.09.94 $(I_x^{lower})$	'time-since-enrolment' of those admitted 01.07 to 31.12.94 (HES)	'time-since-enrolment' of those censused at midnight 30.09.94 (KH07)
0	0.5943	0.4057	0.6668	0.3332	100.00%	100.00%	100.00%	100.00%
92	0.3161	0.6839	0.3562	0.6438	40.57%	33.32%	25.32%	51.95%
183	0.2549	0.7451	0.3046	0.6954	27.74%	21.45%	13.55%	28.46%
273	0.2844	0.7156	0.3714	0.6286	20.67%	14.92%	8.06%	13.94%
365	0.3070	0.6929	0.4277	0.5723	14.79%	9.38%	4.22%	5.82%
457	0.3749	0.6251	0.6207	0.3793	10.25%	5.37%	2.03%	2.07%
548	-	-	-	-	6.41%	2.04%	0.08%	0.42%

**Comparing the length of NHS waiting times: can we trust official statistics?**

**Summary**

In the UK, the Government Statistical Service (GSS) reports the cumulative percentage of elective 'admissions' that took place within a given 'time-since-enrolment' on the waiting list. These percentages are calculated from cross-sectional data using the total number of valid elective episodes within a specified calendar period as denominator and the number of these who were enrolled on the waiting list three or twelve months previously as numerator. The GSS publishes these statistics as an indication of the promptness of elective admission from the waiting list.

Now if these percentages describe patients admitted from a stationary waiting list, they estimate the likely 'times-to-admission' of those destined to be admitted under the same conditions over some subsequent calendar period. But they have nothing to say about the 'times-since-enrolment' of those who will never be admitted. In other words, the published statistics allow those already admitted to look back over their shoulder and assess how typical their experience was. And the published statistics allow those destined to be admitted to assess their chance of admission within any given 'time-since-enrolment'. But patients, clinicians, managers and politicians want to know how long new recruits might expect to wait because they cannot predict whose 'time-since-enrolment' will end in admission and whose 'time-since-enrolment' will end in some competing event. As a result, the published caveats fail to protect users from misinterpreting official statistics: the cumulative percentage 'admitted' is only of interest as an indication of how long new recruits might expect to wait so users assume that this is what it gives.

Counts of the number of patients admitted, removed, put to the back of the waiting list or suspended each quarter were extracted from the KH06 and KH07A returns for 34 Trauma & Orthopaedic waiting lists in South Thames Region. Valid elective episodes in Trauma & Orthopaedics were extracted from *Hospital Episode Statistics* for 34 Provider units in South Thames Region. The GSS method was used to calculate the cumulative proportion of elective 'admissions' within three months (range: 0.62-0.27). KH06 and KH07A counts were used to estimate the likelihood of a waiting time having ended in elective admission rather than some competing event (range: 0.93-0.31). And these two probabilities were multiplied to estimate the cumulative likelihood of elective admission within three months among all those at-risk (range: 0.55-0.12). This measure gives a very different ranking of waiting list performance from the GSS estimate and confirms that elective admission may be very much less prompt than suggested by official statistics.

**Introduction**

**Background**

The Government Statistical Service overestimates the cumulative likelihood of elective admission among those at-risk and underestimates the proportion still waiting at every 'time-since-enrolment' on the waiting list (chapter 5). But the cumulative percentage of valid elective episodes 'admitted' is used to rank the

performance of waiting lists as well as to assess the rapidity of elective admission. Purchasers use these statistics to identify which hospital admitted elective patients most promptly in the past and might be relied upon to do so again in the future<sup>1</sup> and providers use them to compare their performance with that of their competitors<sup>1</sup>. Patients are encouraged to use the cumulative percentage of valid elective episodes 'admitted', within three or twelve months of enrolment, to decide which waiting list they would prefer to join<sup>2</sup>. And Members of Parliament use such statistics to compare local services with the standard available nationally<sup>3</sup>. Does the cumulative percentage of valid elective episodes 'admitted' give a reliable indication of ranked performance despite its inaccuracy as a measure of how long those at-risk might expect to wait<sup>2</sup>?

Waiting lists are compared using the number admitted within three months or the number admitted within twelve months as proportions of all those admitted electively<sup>1,2</sup>. We capture information on all those admitted during a specified calendar period, measure the length of time that each individual waited for elective admission and summarise the data by calculating the proportion admitted within three months of their enrolment on the list. But this approach resembles the use of proportional mortality ratios to compare age-specific mortality<sup>4</sup> where we capture information on all those who died during a specified calendar period, measure the age of each individual at death and summarise the data by calculating the proportion that died before reaching a particular anniversary. As a result, we can expect the cumulative percentage of valid elective episodes 'admitted' to suffer from the same difficulties associated with the cumulative proportion that died. So when the proportion admitted within three months from one waiting list appears high, we do not know whether this is due to a high rate of admission within the first three months of enrolment or to a low rate of admission thereafter. Does the cumulative percentage of valid elective episodes 'admitted' give a reliable indication of ranked performance despite its inability to allow for variation in the structure of person-time at-risk?

### Objectives

This chapter compares 11 specialty-specific waiting lists for England at 30 September 1994 using the cumulative percentage of valid elective episodes 'admitted' and lifetable estimates of the cumulative likelihood of elective admission among those at-risk. It discusses the circumstances in which we might expect the same ranked performance on both measures and examines whether 11 specialty-specific waiting lists for England met these conditions. It also examines whether these conditions were satisfied by Trauma & Orthopaedic waiting lists at 34 hospitals in South Thames Region between 1 July and 31 December 1994.

### **Materials & Methods**

#### Approximate estimates of the cumulative likelihood of elective admission among all those at-risk

The internal consistency of the KH06<sup>5</sup>, KH07A<sup>5</sup> and KH07<sup>5,6</sup> returns was examined for the 11 specialties which contributed 90% of those at-risk of elective admission in England between 1 July and 31 December 1994 (table 6.1 & appendix 6). Upper and lower lifetable estimates were then calculated for each specialty at 30 September 1994 using the method described in chapter 5 (tables 6.3, 6.4 & appendix 6).



Figure 6.1: Lexis diagrams describing imputation from KH06, KH07A and KH07 data and from valid elective episodes. (Trauma & Orthopaedics (110), all NHS hospitals in England)

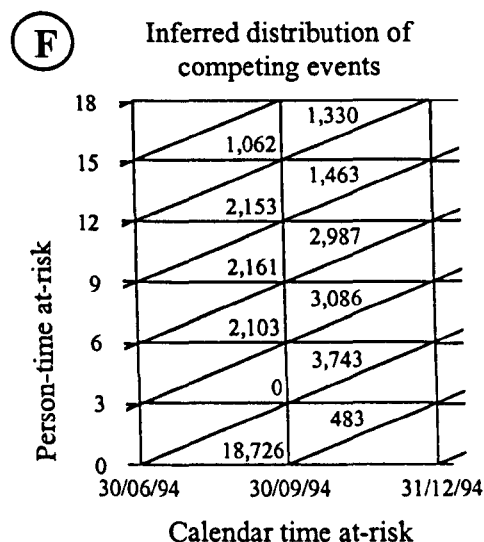
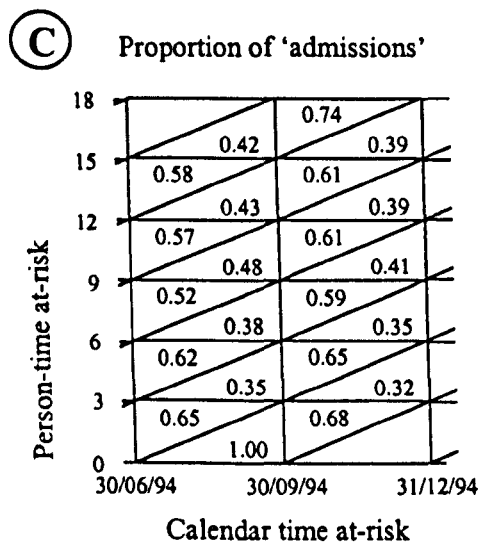
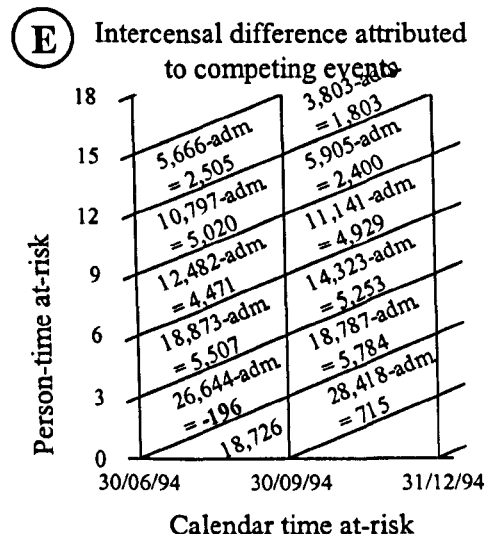
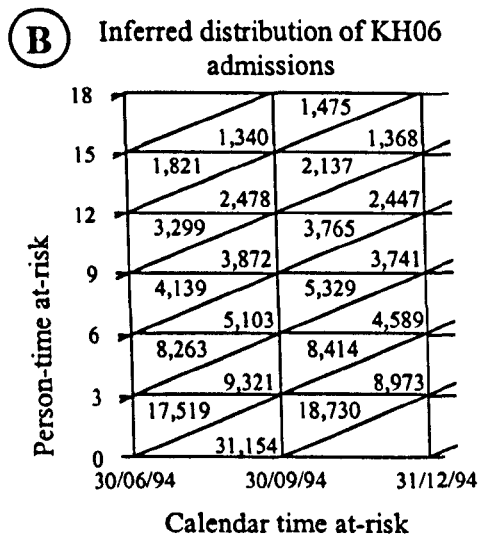
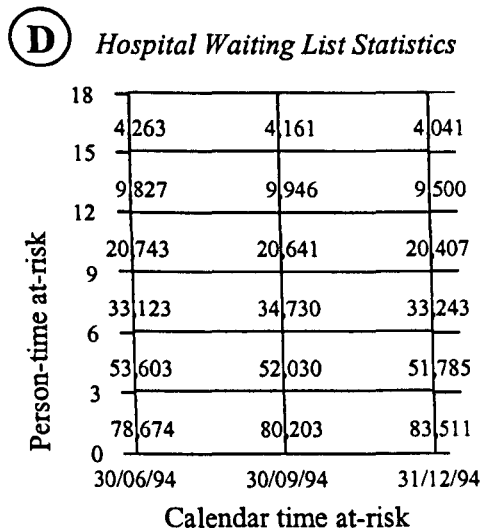
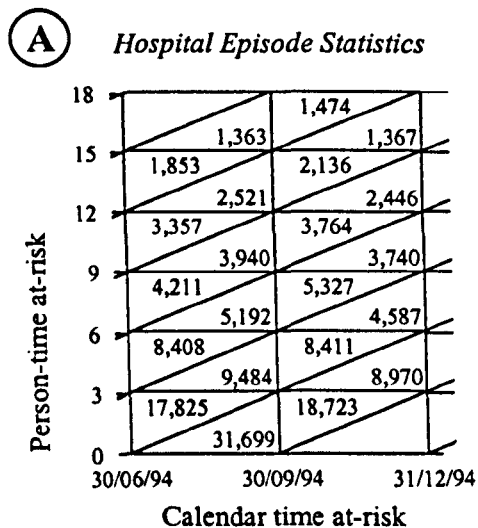

Despite scaling the count of valid elective episodes<sup>7</sup> up or down to a level consistent with the count of admissions reported in the KH06 return (table 6.2), the inferred distribution of ‘times-to-admission’ (figure 6.1, B) conflicts with the loss of patients from enrolment cohorts over the intercensal period (figure 6.1, E).

There appear to be too few competing events and too many elective admissions in the 0-3 and 3-6 month waiting time categories following the 0-3 month census count on 30 June 1994. As a result, combining data from the KH06, KH07 and KH07A returns and from valid elective episodes gives impossible results for Urology, Trauma & Orthopaedics, Ophthalmology, Plastic & Burns Surgery and Cardiothoracic Surgery and implausible results for General Surgery, ENT, Oral Surgery, General Medicine, Cardiology and Obstetrics & Gynaecology (appendix 6, figures 6.1, E) even at the level of waiting lists for all England. So tables 6.5 and 6.6 are unable to give a robust answer to the question of whether lifetable estimates would change the ranking of relative performance three months and twelve months after enrolment on the waiting list.

#### Published estimates are conditional on ‘having been admitted’

In the UK, the Government Statistical Service reports the cumulative percentage of elective ‘admissions’ that took place within a given ‘time-since-enrolment’ on the waiting list. These percentages are calculated from cross-sectional data<sup>7</sup> using the total number of valid elective episodes within a specified calendar period as denominator and the number of these who were enrolled on the waiting list three or twelve months previously as numerator. The Government Statistical Service publishes these statistics as an indication of the promptness of elective admission from the waiting list.

Now the cumulative percentage of valid elective episodes ‘admitted’  $\left( {}_{x+n}q_0^{admissions} \right)$ , within three months or within twelve months, excludes all those who have yet to be admitted. As a result, the measure fails to allow for changes in the structure of person-time ‘at-risk’ such as those produced by variation in the number recruited to a waiting list each quarter and by variation in the number admitted electively from it each quarter. So the cumulative percentage of valid elective episodes ‘admitted’ will only give the same ranking as the cumulative likelihood of admission among those ‘admitted’ electively  $\left( {}_{x+n}q_0^{RR} \right)$  if each waiting list shows the same historical increases and decreases in recruitment and admission (chapter 3) and in category-specific conditional likelihoods (chapter 4). Perhaps more importantly, the cumulative percentage of valid elective episodes ‘admitted’ excludes all ‘times-since-enrolment’ that end in a competing event (chapter 2). At best, the estimates published by the Government Statistical Service only describe those fortunate enough to have already been admitted and only apply to those destined to be admitted at some point in the future. They do not describe the cumulative likelihood of elective admission among all those at-risk  $\left( {}_{x+n}q_0 \right)$ .

#### The multiplicative rule

Figure 6.2 shows how we calculate the chance of getting a double-six when we throw a pair of dice. The probability of getting a six on one die is quite independent of the probability of getting a six on the other.

(It is a peculiarity of this example that the two independent probabilities have the same value and that there is no natural order to them: it doesn't matter which die is thrown first or whether they are thrown together.) There is a  $1/6$  chance of throwing a six on the 'second' die having already got a six on the 'first' so we expect to get a double-six one in six out of one in six throws i.e.,  $1/6 \times 1/6 = 1/36$ .

Figure 6.2: Conditional and unconditional likelihoods - have we been given the complete picture?

'First' die	'Second' die	Chance of throwing a double-six
$\frac{1}{6}$	$\times$	$=$
$\frac{1}{6}$	$\frac{1}{6}$	$\frac{1}{36}$

Proportion of 'times-since-enrolment' ending within three months, as a result of elective admission rather than a competing event	Cumulative likelihood of elective admission within three months, conditional on 'having been admitted' electively	Cumulative likelihood of elective admission within three months among all those 'at-risk'
$1.00$	$\times$	$=$
$0.75$	$0.75$	$0.75$

We could use a similar approach to calculate the cumulative likelihood of elective admission within three months among those at-risk ( ${}_3q_0$ ). We assume that our two probabilities are independent, we expect that they will seldom share the same value and we recognise that they have a definite order: the second probability is conditional on the first. The first probability is the likelihood that a 'time-since-enrolment' ending within three months ended in elective admission rather than some competing event ( $p(3)$ )<sup>9</sup>. The second probability is the cumulative likelihood of admission within three months among those 'admitted' electively ( ${}_3q_0^{pRr}$ ). And we calculate the cumulative likelihood of elective admission within three months among those at-risk by simple multiplication<sup>8</sup> i.e.,  ${}_3q_0 = {}_3q_0^{pRr} \times p(3)$ . Figure 6.2 calculates the cumulative likelihood of elective admission within three months among those at-risk where all 'times-since-enrolment' ending within three months ended in elective admission ( $p(3) = 1.00$ ).

Generalising from this formula, we could calculate the cumulative likelihood of elective admission among those at-risk ( ${}_{x+n}q_0$ ), multiplying the cumulative likelihood of admission among those 'admitted'

electively ( ${}_{x+n}q_0^{PRr}$ ) by the likelihood of a waiting time ending in elective admission rather than some competing event, within a specified 'time-since-enrolment' ( $p(x+n)$ ). Now if the values taken by  $p(x+n)$  were the same for each waiting list, we would expect to get the same ranked performance regardless of whether we used the cumulative likelihood of elective admission among those at-risk ( ${}_{x+n}q_0$ ) or the cumulative likelihood of admission among those 'admitted' electively ( ${}_{x+n}q_0^{PRr}$ ). Unfortunately, no information is collected on the length of 'times-to-competing-event' so we cannot check any of the specific  $p(x+n)$  values using Department of Health data.

However, waiting lists can only have the same  $p(x+n)$  values at each and every 'time-since-enrolment', if the overall ratio of elective admissions to elective admissions plus competing events ( $p(\infty)$ ) were the same for each list regardless of 'time-since-enrolment'. The KH06<sup>5</sup> and KH07A<sup>5</sup> returns provide the information we need to calculate the proportion of 'times-since-enrolment' which ended in elective admission rather than some competing event i.e., the likelihood of 'having been admitted'. For the purposes of this chapter we will assume that Government Statistical Service estimates ( ${}_3q_0^{admissions}$ ) describe stationary waiting lists so that the cumulative proportion of valid elective episodes 'admitted' equals the cumulative likelihood of admission among those admitted electively ( ${}_3q_0^{admissions} = {}_3q_0^{PRr}$ ). This allows us to calculate the cumulative likelihood of elective admission within three months of enrolment among those at-risk as  ${}_3q_0 = {}_3q_0^{admissions} \times p(\infty)$ .

## Results

### The quality of administrative data

The Department of Health does not collect information on the numbers leaving the waiting list each quarter as a result of deferral on medical grounds. Nor does the Department of Health collect information on the numbers rejoining the waiting list each quarter as a result of being 'put-to-the-back-of-the-queue' or as a result of 'reinstatement'. But if the KH06, KH07 and KH07A returns gave a complete and accurate report then the numbers entering (E) the population at-risk of elective admission should exactly equal the numbers leaving (L) i.e., the 'error of closure' should be 0.00%. So in preparing tables 6.1 and 6.8, we have assumed that the number 'reset-to-zero' exactly equals the number self-deferring or failing to attend that quarter and that the number 'reinstated' exactly equals the number deferred on medical grounds or suspended on administrative grounds. We view large 'errors of closure' as indicating poor data quality.

Table 6.1 shows how the internal consistency of the KH06, KH07A and KH07 returns varied from one specialty to another in England (-0.1% to -5.3%) and table 6.8 confirms that sub-groups defined even more finely show even more variation (+8.5% to -12.2%). Plastic & Burns Surgery is the specialty which underestimated the numbers entering or overestimated the numbers leaving the population at-risk of elective admission most seriously between 1 July and 31 December 1994 (table 6.1). But inconsistency is much more impressive at the level of the individual provider unit (table 6.8). Trauma & Orthopaedic units

at RDM, RGW, RGZ and RPD submitted counts that were perfectly consistent for the period 1 July to 31 December 1994 and the KH06, KH07 and KH07A returns completed by RAX, RGV, RHE, RJZ, RPF, RPL and RPS had 'errors of closure' within  $\pm 0.5\%$ . But at the other end of the scale, the counts submitted by RCY (-334%) and RGX (-69.2%) bear little relation to the true position: in fact it seems likely that RCY and RGX failed to submit their KH07<sup>6</sup> returns for 30 June 1994. And there was little room for complacency at RG2 (-12.2%), RPA (-9.0%), RN7 (-7.4%), RPC (-6.0%), RJ7 (-5.0%) or RJ2 (+5.3%).

The Department of Health does not collect information on the 'times-since-enrolment' of those counted as admissions on the KH06 return nor does it count the number of competing events associated with the 'times-since-enrolment' ending as valid elective episodes in *Hospital Episode Statistics*. So we want to assume that the distribution of the 'times-since-enrolment' of valid elective episodes is the same as the unknown distribution of the 'times-since-enrolment' of the KH06 admissions. The simplest check on the validity of this assumption is shown in tables 6.2 and 6.9.

Table 6.2 shows how the ratio of valid elective episodes to KH06 admissions varies from specialty to specialty (0.96 to 1.94). Data from the KH07 census and from the *Hospital Episode Statistics* are sometimes used interchangeably as though reflecting different aspects of the same population e.g., as though the 'admissions' database and the census count relevant 'lifelines' from the same population of 'times-since-enrolment'. This practice seems reasonable in Obstetrics & Gynaecology, Oral Surgery and Trauma & Orthopaedics where the count of KH06 admissions almost equals the number of valid elective episodes but becomes absurd when we look at General Medicine where there are substantially fewer admissions for each valid elective episode. In this case, the 'units' counted as admissions on the KH06 return must be very different from the 'units' collated electronically as elective episodes with valid dates of enrolment.

Table 6.9 shows how the ratio of valid elective episodes to KH06 admissions varies from hospital to hospital (0.71 to 4.84) in Trauma & Orthopaedics. Here we find the number of valid elective episodes and KH06 admissions were very similar for a number of Trauma & Orthopaedic waiting lists in South Thames Region (RAX, RAZ, RDV, RHE, RHG, RHH, RJ7, RPC, RPR, RPS). As a result, KH06 admissions might be viewed as giving an early though error-prone estimate of the number of valid elective episodes to be expected. And substantial discrepancies between the two counts might be viewed as indicating poor data collection. (In fact, were we to use elective episodes with enrolment dates regardless of whether they are valid or not, we could include the effect of failing to replace the default date ('15 Oct 1582') with a more plausible value (cf. RCY, appendix 3, table 3.3b).)

Where the number of elective episodes with valid enrolment dates and the count of KH06 admissions are similar, we can substitute one for the other in table 6.8 without substantially increasing the size of the 'error of closure' e.g., RGZ (0.00%), RGW (-0.01%) and RGV (-0.01%) (appendix 6, table 6.8a). We surmise that electronic downloads for *Hospital Episode Statistics* match enrolment dates with the first elective episode identified for each entry on the waiting list. And table 6.9a (appendix 6) highlights the fact that

there were many more elective episodes (with or without enrolment dates) than KH06 admissions: there were as many as 3.37 elective episodes for each valid elective episode in Trauma & Orthopaedic units, South Thames Region.

### The effect on ranked performance

Table 6.7 shows how the likelihood of 'having been admitted' ( $p(\infty)$ ) varies from specialty to specialty (0.85-0.65) and table 6.10 again confirms that sub-groups defined even more finely show even more variation (0.93-0.31). ( $p(\infty)$  is calculated as the ratio of all KH06 admissions to all those admitted, removed, self-deferred, failed, deferred or suspended between 1 July and 31 December 1994.) In view of this, the cumulative proportion of valid elective episodes 'admitted' within three months ( ${}_3q_0^{\text{admissions}}$ ) will probably give a very different ranking from the cumulative likelihood of elective admission within three months among those at-risk ( ${}_3q_0$ ).

Figure 6.3 shows how ranked performance depends upon the measure used. Of 34 Trauma & Orthopaedic units in South Thames Region, only RDR and RPR occupied exactly the same rank position on  ${}_3q_0$  as on  ${}_3q_0^{\text{admissions}}$ . And a Spearman's correlation coefficient of 0.73 suggests that ranked performance on  ${}_3q_0^{\text{admissions}}$  only predicts ranked performance on  ${}_3q_0$  with 53% accuracy.

## **Discussion**

### Limitations of approximate lifetable

The Government Statistical Service collects no information on the length of 'times-since-enrolment' of the KH06 admission or on the length of 'times-since-enrolment' of 'waits' ending in a competing event. So in chapter 5, we assumed that the 'times-since-enrolment' of KH06 admissions were distributed in the same fashion as the 'times-since-enrolment' of valid elective episodes despite a substantial disparity between the two sets of counts for All Specialties (1999: table 6.2). We assumed that the loss of patients from a cohort over the intercensal period was due either to 'admission' or to the occurrence of a competing event. And we assumed that the distribution of competing events between waiting time categories was the same as the distribution of 'admissions' from the enrolment cohort. As a result, there are three reasons approximate lifetables cannot establish how ranked performance would change with the introduction of exact lifetables.

1. The approximate method ties the attributed 'times-since-enrolment' of KH06 admissions to the observed 'times-since-enrolment' of valid elective episodes within the cross-tabulation of waiting time category, enrolment cohort and quarter of 'admission'. Yet it is evident from figure 6.1, E, that the imputed 'times-since-enrolment' must differ from the real 'times-since-enrolment' even when there is little disparity between numbers of valid elective episodes and the count of KH06 admissions. Between 1 July and 30 September 1994, KH06 returns reported 91,208 admissions from Trauma & Orthopaedic waiting lists in England. The count of valid elective episodes for Trauma & Orthopaedics during this period came to 92,803 - an excess of only 1.75%. Yet the

Figure 6.3: Does the cumulative proportion of valid elective episodes 'admitted' give a reliable indication of the cumulative likelihood of elective admission within three months of enrolment? (Trauma & Orthopaedics at 34 hospitals in South Thames Region - 1 July to 31 December 1994)

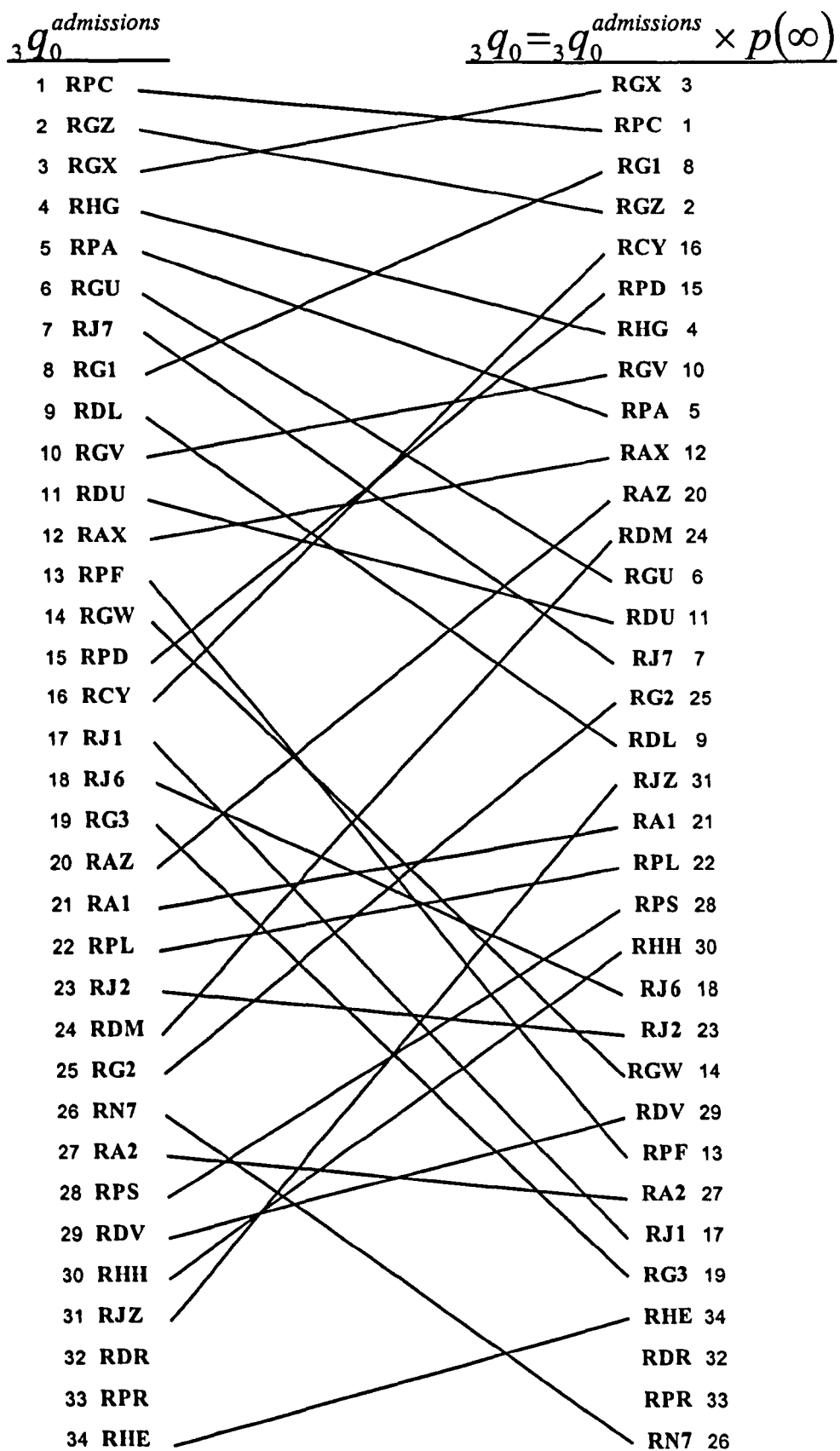

Spearman's  $r = 0.73$

number of KH06 admissions attributed to the cohort enrolled between 1 April and 30 June exceeds the count of patients lost during the intercensal period 1 July to 30 September (figure 6.1, B & E). The ‘times-since-enrolment’ of valid elective episodes are clearly not the same as the ‘times-since-enrolment’ of the KH06 admissions generated by the population sampled in the KH07 census. As a result, KH07 census counts and *Hospital Episode Statistics* should no longer be used as two views on the same population; they enumerate the size and throughput of the English waiting list in different ‘units’ and measure the length of waiting times under different definitions of person-time at-risk. (Alternatively, we might take the view that the KH07 census fails to count all those still at-risk of elective admission in the 0-3 month waiting time category e.g., by at least  $873/(16,128+873) = 5.13\%$  at midnight 30 June 1994 in the case of Plastic & Burns Surgery (160) (appendix 6).)

2. The approximate method makes the number of competing events depend upon the distribution of valid elective episodes between enrolment cohorts and quarter of ‘admission’ and upon the difference between successive census counts in successive waiting time categories. It even ties ‘times-to-competing-events’ to the distribution of valid elective episodes between waiting time categories within a cohort during a quarter. This ignores the possibility of reinstatement to the waiting list and eliminates much of the variation we would expect to see in practice. For example, the error of closure is fixed at 0.00%. And the ‘times-to-competing-events’ are made to follow a random, non-informative distribution, which assumes that competing events cannot be used to clear patients off the waiting list.
  
3. Unless we have more and better data or make further assumptions, the approximate method cannot give a single precise cumulative likelihood of elective admission among those at-risk  $({}_{x+n}q_0)$ . Three months after enrolment on specialty-specific waiting lists for England, the upper and lower estimates lie 3-13 percentage points apart. This indicates the amount of uncertainty when we don’t even know the order in which competing events occur relative to admissions, within a waiting time category.

#### Should we expect a change in ranked performance?

Chapter 4 has already confirmed that the cumulative likelihood of admission among those ‘admitted’ electively  $({}_{x+n}q_0^{pRr})$  will be smaller than the cumulative proportion of valid elective episodes ‘admitted’  $({}_{x+n}q_0^{admissions})$  where the size of the population at-risk has been increasing. And where the size of the population at-risk has been decreasing, the cumulative likelihood of admission among those ‘admitted’ electively will be larger than the cumulative proportion of valid elective episodes ‘admitted’. Moreover, the size of the difference between the two measures may be larger, smaller or in the opposite direction when we compare one waiting list with another unless both waiting lists experienced the same historical increases and decreases in recruitment and admission rates. For the purposes of illustration, this chapter assumes that waiting lists were stationary i.e., that  ${}_{x+n}q_0^{admissions} = {}_{x+n}q_0^{pRr}$ .



And chapter 5 has already confirmed that the cumulative likelihood of elective admission among all those at-risk ( ${}_{x+n}q_0$ ) will be smaller than the cumulative proportion of valid elective episodes 'admitted'. But the routinely available data does not allow us to produce reliable lifetable estimates so we cannot use this approach to assess the actual effect on ranked performance. Instead, we have to consider how the Government Statistical Service estimate would be changed by moving to lifetable estimation of the cumulative likelihood of elective admission among all those at-risk. Should we expect the published statistics for each waiting list to be reduced by the same fixed ratio, as in figure 6.2, or should we expect the reduction to vary from one group of patients to another?

Table 6.7 showed the proportion of patients whose experience of the waiting list ended in admission from specialty-specific waiting lists rather than some competing event. Although the likelihoods of 'having been admitted' ranged from 0.85 to 0.65 over 11 specialty-specific waiting lists for England, they were almost identical for General Surgery, Urology and Ophthalmology. As a result, we might expect lifetable methods to estimate a cumulative likelihood of elective admission among those at-risk which is smaller than the cumulative proportion of valid elective episodes 'admitted', without altering ranked performance. But very different likelihoods of 'having been admitted' change the apparent performance of Trauma & Orthopaedics much more than that of General Medicine. This suggests that ranked performance will only be unaffected if the likelihoods of 'having been admitted' show very little variation compared with the cumulative proportion of valid elective episodes 'admitted' ( ${}_3q_0^{admissions}$ : 0.95-0.53) and if the likelihoods of 'having been admitted' are positively correlated with the cumulative proportion of valid elective episodes 'admitted'.

We have already discussed the consistency of counts submitted to the Department of Health in the KH06, KH07 and KH07A returns for the period 1 July to 31 December 1994. Although some of the data submitted on Trauma & Orthopaedic waiting lists was exemplary, the returns completed by other provider units fell far short of this standard. Now the size of the Government Statistical Service underestimate and its precise effect on ranked performance clearly depend on the size of the likelihood of 'having been admitted' over the period of interest. But the validity of the argument presented here does not depend on the quality of the data used to illustrate it. If the Government Statistical Service method is applied to 'open' waiting lists, it will underestimate the cumulative likelihood of elective admission among all those at-risk. And if the likelihoods of 'having been admitted' were very variable, the Government Statistical Service method will also yield misleading performance indicators.

#### Limitations of conditional likelihoods

The approach described here assumed that the waiting lists were stationary so that the cumulative proportion of valid elective episodes 'admitted' exactly equalled the cumulative likelihood of admission among those 'admitted' electively i.e.,  ${}_{x+n}q_0^{admissions} = {}_{x+n}q_0^{DR}$ . In fact, the error produced by non-stationary rates of recruitment and admission and by category-specific conditional likelihoods of elective

admission further weakens the correlation between Government Statistical Service estimates and the cumulative likelihood of elective admission among those at-risk ( ${}_{x+n}q_0$ ).

Moreover, the approach described assumes that the two probabilities,  $p(x+n)$  and  ${}_{x+n}q_0^{RR}$ , are independent i.e., that competing events occur at random regardless of the length of ‘time-since-enrolment’ so that  $p(3)$  and  $p(12) = p(x+n) = p(\infty)$ . Now in survival analysis this convenient hypothesis has to be tested rather than just taken for granted. If competing events occurred ‘informatively’, rather than ‘non-informatively’, this would be evidence that competing events were used to change the shape of the distribution of ‘times-since-enrolment’. As a result, although we know that the Government Statistical Service estimate is over-optimistic, we still don’t know the size of the overestimate because the Department of Health does not collect information on the length of ‘times-since-enrolment’ which ended in competing events.

Let us imagine that the likelihood of a ‘time-since-enrolment’ ending in elective admission rather than a competing event does depend upon the length of ‘time-since-enrolment’ so that  $p(x+n) \neq p(\infty)$ . In other words, the actual value of  $p(3)$  might be smaller than the calculated value of  $p(\infty)$  so that  ${}_3q_0$  should be very different from  ${}_3q_0^{admissions}$  or  $p(3)$  might be larger than the calculated value of  $p(\infty)$  so that  ${}_3q_0$  should not be so very different from  ${}_3q_0^{admissions}$ . And let us assume that no ‘time-since-enrolment’ ended in a competing event within three months of enrolment so that  $p(3) = A_0 / (A_0 + C_1)$ . ( $A_0$  represents the number of KH06 admissions from the 0-3 month waiting time category and  $C_1$  represents all competing events, none of which were generated by the 0-3 month waiting time category.)

This can be rearranged so that 
$$p(3) = \frac{({}_3q_0^{admissions} \times \text{KH06 admissions})}{({}_3q_0^{admissions} \times \text{KH06 admissions}) + \text{Competing Events}}$$

Now the scope for variation from  $p(\infty)$  will be greatest where  $p(\infty)$  and  ${}_3q_0^{admissions}$  take values furthest from 1.0. If three months was the critical ‘time-since-enrolment’ used to assess waiting list performance and if competing events were used to clear ‘long-waiters’ off the list, this formula would show the amount of uncertainty concerning the true cumulative likelihood of elective admission within three months among those at-risk.

### Conclusions & Recommendations

The Government Statistical Service has chosen to exclude ‘times-since-enrolment’ ending in competing events from analyses of patient waiting times.  $p(\infty)$  can be viewed as the ratio of the advertised cumulative proportion of valid elective episodes ‘admitted’ to the true cumulative likelihood of elective admission among those at-risk. So by its own account, the true cumulative likelihood of elective admission among those at-risk at Dartford & Gravesham NHS Trust (RN7) was only 31% of the value reported by the Government Statistical Service. And as  $p(\infty)$  is the proportion of the population at-risk

whose ‘times-since-enrolment’ ended in elective admission,  $(1 - p(\infty))$  represents the proportion ending in a competing event instead. According to Dartford and Gravesham NHS Trust, 69% of the ‘times-since-enrolment’ which ended between 1 July and 31 December 1994 ended in some fashion other than elective admission. In the absence of a reliable estimate of the cumulative likelihood of elective admission among all those at-risk, we need to know the likelihood of ‘having been admitted’: we want to know whether we will get admitted before we need to how quickly such admission might take place.

We have argued that ranked performance depends on the method used to estimate the cumulative likelihood of elective admission among those at-risk. Although the data collected by the Government Statistical Service does not lend itself to an empirical demonstration of the effect of adopting exact lifetable estimates it does lead us to expect a substantial change in ranked performance. So the implications for published statistics are considerable. Official estimates of how long patients might expect to wait for admission would be seriously misleading even if the raw data were 100% complete, entirely accurate and perfectly valid. And the bias described here will invalidate the published ranking of hospitals even if they use common definitions of clinical priority<sup>11</sup>, serve an identical mix of cases and have the same thresholds for adding patients to waiting lists<sup>12</sup>. As a result, we might expect *Health Service Indicators* to have misled purchasers about the relative performance of hospitals serving their residents. And we might expect *The NHS Performance Guide* to have misrepresented the relative performance of hospitals and specialties to members of the public.

The implications for patients and services are more difficult to assess and depend on whether official statistics had any effect on referrals and how they were used to choose one waiting list rather than another. If patients were referred to Trauma & Orthopaedic waiting lists regardless of the ranked performance of the units in question, the ranking was irrelevant and so was the bias! But if patients were referred to lists which appeared to offer prompter admission, official statistics have misled some of the very people who were prepared to shop around for better services and whose mobility is the nearest thing to competition that exists in the UK NHS. We believe there is a danger that existing statistics may continue to be used for want of anything better or may needlessly discredit other summary measures from these publications. We therefore recommend that these performance indicators be withdrawn or published alongside estimates of the likelihood of ‘having been admitted’ ( $p(\infty)$ ) until lifetable estimates can be calculated using exact data from the Patient Administration System (chapter 5).

## References

1. NHS Executive. *Health Service Indicators. Background information 1994/95*, Government Statistical Service, FPA - Performance Analysis, Leeds, 1996. WL44, WL92-WL94.

2. NHS Executive. *How long might you expect to wait for ... an ambulance? a hospital appointment? an operation? How do your local health services measure up to the Patient's Charter?*, Department of Health, Leeds, 1997.
3. 'Waiting times', In: *House of Commons Hansard* for 12 November 1996, (part 21), columns 185, 186.
4. Hennekens CH, Buring JE. *Epidemiology in Medicine*, [Edited by Mayrent SL.], Little, Brown & Co., Boston, 1987. Page 85.
5. Department of Health, NHS Management Executive, Information Management Group. 'Patients awaiting elective admission', In: *The data manual: module 1: hospital services. Version 1.0*, Department of Health, Stanmore, 1992. Pages 5/15-5/18.
6. Department of Health, NHSME. *Hospital waiting list statistics: England at 30 September 1994*, Government Statistical Service, Finance and Corporate Information Division, Branch MIAB, Leeds, 1994.
7. Department of Health. *Hospital Episode Statistics. Volume 3. Finished consultant episodes: waiting time of elective admissions by diagnosis and operation; injury/poisoning by external causes. ENGLAND: Financial year 1994-95*, Government Statistical Service, 1996.
8. Kirkwood BR. 'Probability', In: *Essentials of Medical Statistics*, Blackwell Scientific Publications, Oxford, 1988.
9. Estève J, Benhamou E, Raymond L. *Statistical Methods in Cancer Research. Volume IV. Descriptive Epidemiology*, [Translated from French by Sinclair M.], International Agency for Research on Cancer (WHO), IARC Scientific Publications No. 128, Lyons, 1994. Page 12.
10. Government Committee on Choices in Health Care. 'Rationing: who is next?', In: *Choices in Health Care*, Ministry of Welfare, Health and Cultural Affairs, Rijswijk, The Netherlands, 1992. Pages 102, 104.
11. Pope CJ, Roberts JA, Black NA. 'Dissecting a waiting list', *Health Services Management Research*, 4(2), 112-119 (1991). Page 117.
12. Sanderson HF. 'What's in a waiting list?', *BMJ*, 285, 1368-1369 (1982).

Table 6.1: Internal consistency of KH06, KH07A and KH07 returns for period 1 July to 31 December 1994 inclusive  
BY specialty (England)

	Entering the group 'at-risk' of admission (E)					Leaving the group 'at-risk' of admission (L)						
	Censused 30.06.94 [KH07]	'Decisions- to-admit' [KH06]	'Reset-to- zero' *	'Re- instated' †	Error of Closure E-L (% = [E-L]/E*100)	Admitted [KH06]	Removed [KH06]	<i>Self-deferred</i> [KH07A]	<i>Failed</i> [KH06]	<i>Medic. Defrdr</i> [KH06]	<i>Suspended</i> [KH06]	<i>Censused</i> 31.12.94 [KH07]
	General Surgery	217,696	403,788	<i>60,763</i>	<i>10,492</i>	-5,344 (-0.8%)	361,434	50,577	<i>39,280</i>	<i>21,483</i>	-	<i>10,492</i>
Urology	90,061	160,191	<i>22,525</i>	<i>3,516</i>	-1,080 (-0.4%)	141,187	21,443	<i>12,556</i>	<i>9,969</i>	-	<i>3,516</i>	<i>88,702</i>
Trauma & Orthopaedics	200,911	222,914	<i>42,405</i>	<i>14,312</i>	-8,394 (-1.8%)	184,464	44,796	<i>31,101</i>	<i>11,304</i>	-	<i>14,312</i>	<i>202,959</i>
ENT	128,066	162,374	<i>30,981</i>	<i>4,575</i>	-5,043 (-1.6%)	149,811	23,826	<i>18,751</i>	<i>12,230</i>	-	<i>4,575</i>	<i>121,846</i>
Ophthalmology	119,435	147,553	<i>16,345</i>	<i>4,452</i>	-6,893 (-2.4%)	131,535	23,387	<i>9,900</i>	<i>6,445</i>	-	<i>4,452</i>	<i>118,959</i>
Oral Surgery	63,840	83,905	<i>16,347</i>	<i>3,394</i>	-1,319 (-0.8%)	72,176	13,515	<i>10,317</i>	<i>6,030</i>	-	<i>3,394</i>	<i>63,373</i>
Plastic & Burns Surgery	42,609	56,669	<i>10,104</i>	<i>2,433</i>	-5,908 (-5.3%)	51,320	8,830	<i>6,405</i>	<i>3,699</i>	-	<i>2,433</i>	<i>45,036</i>
Cardiothoracic Surgery	10,800	18,810	<i>1,081</i>	<i>190</i>	-31 (-0.1%)	16,989	1,928	<i>644</i>	<i>437</i>	-	<i>190</i>	<i>10,724</i>
General Medicine	17,217	91,524	<i>7,674</i>	<i>389</i>	-1,234 (-1.1%)	84,782	7,480	<i>3,170</i>	<i>4,504</i>	-	<i>389</i>	<i>17,713</i>
Cardiology	15,924	33,337	<i>2,797</i>	<i>149</i>	-675 (-1.3%)	30,624	3,472	<i>1,510</i>	<i>1,287</i>	-	<i>149</i>	<i>15,840</i>
Obstetrics & Gynaecology	121,250	273,864	<i>32,425</i>	<i>4,065</i>	-4,198 (-1.0%)	248,670	32,971	<i>19,000</i>	<i>13,425</i>	-	<i>4,065</i>	<i>117,671</i>

\* Estimated as the number who self-deferred or failed-to-attend for admission to hospital that quarter

† Estimated as the number temporarily suspended or deferred on medical grounds that quarter

Note: The numbers in italics contribute nothing to the difference between E and L so the 'error of closure' is really a comparison of columns 2 & 3 with columns 7, 8 & 13.

Table 6.2: Ratio of valid \* elective episodes (HES) to KH06 admissions BY specialty BY quarter of admission

Specialties	1 June to 30 September 1994 incl.			1 October to 31 December 1994 incl.			OVERALL
	HES	KH06	HES/KH06	HES	KH06	HES/KH06	HES/KH06
General Surgery	189,229	182,411	1.04	188,811	179,023	1.06	1.05
Urology	78,161	69,266	1.13	80,084	71,921	1.11	1.12
Trauma & Orthopaedics	92,803	91,208	1.02	93,221	93,256	1.00	1.01
ENT	72,277	74,288	0.97	72,516	75,523	0.96	0.97
Ophthalmology	61,779	63,723	0.97	64,527	67,812	0.95	0.96
Oral Surgery	36,185	36,475	0.99	35,691	35,701	1.00	1.00
Plastic & Burns Surgery	24,681	25,649	0.96	24,755	25,671	0.96	0.96
Cardiothoracic Surgery	9,598	8,637	1.11	9,278	8,352	1.11	1.11
General Medicine	81,860	42,939	1.91	82,566	41,843	1.97	1.94
Cardiology	17,225	15,595	1.10	17,140	15,029	1.14	1.12
Obstetrics & Gynaecology	124,913	124,153	1.00	123,250	123,781	1.00	1.00
<b>All specialties (999)</b>	<b>1,007,103</b>	<b>832,065</b>	<b>1.21</b>	<b>1,010,582</b>	<b>833,682</b>	<b>1.21</b>	<b>1.21</b>

\* Episodes where the date of enrolment was neither blank nor set to '15 Oct 1582'

Table 6.3: Counts of those listed on the English waiting list for Trauma & Orthopaedics (110) around 30 September 1994

Completed waiting time (days)	Admissions pre-census ( ${}_n A_x^+$ )	Admissions post-census ( ${}_n A_x^-$ )	'Person-quarters' at- risk ( ${}_n P_x$ )	Competing events pre-census ( ${}_n C_x^+$ )	Competing events post-census ( ${}_n C_x^-$ )
0	31,154	18,730	80,203	18,726	483
92	9,321	8,414	52,030	0 *	3,743
183	5,103	5,329	34,730	2,103	3,086
273	3,872	3,765	20,641	2,161	2,987
365	2,478	2,137	9,946	2,153	1,463
457	1,340	1,475	4,161	1,062	1,330
548					

\* This is actually estimated as -68 in figure 6.1 and is too small to be true

Table 6.4: Are there four alternative measures of the 'time-to-admission' of those listed on the English waiting list for Trauma & Orthopaedics around 30 September 1994?

Completed waiting time (days)	Chance of being admitted	Chance of not being admitted	Chance of being admitted	Chance of not being admitted	'time-to-admission' of those listed at 30.09.94	'time-to-admission' of those listed at 30.09.94	'time-since-enrolment' of those admitted 01.07 to 31.12.94	'time-since-enrolment' of those censused at midnight 30.09.94
	$({}_n Q_x^{upper})$ (2.3)	$({}_n P_x^{upper})$	$({}_n Q_x^{lower})$ (2.4)	$({}_n P_x^{lower})$	$(I_x^{upper})$	$(I_x^{lower})$	(HES)	(KH07)
0	0.3835	0.6165	0.4499	0.5501	100.00%	100.00%	100.00%	100.00%
92	0.2891	0.7109	0.3079	0.6921	61.65%	55.01%	46.81%	60.36%
183	0.2488	0.7512	0.2839	0.7161	43.83%	38.07%	27.85%	34.64%
273	0.2863	0.7137	0.3548	0.6452	32.93%	27.27%	17.46%	17.47%
365	0.3166	0.6834	0.4210	0.5790	23.50%	17.59%	9.51%	7.27%
457	0.4289	0.5711	0.6749	0.3251	16.06%	10.19%	4.69%	2.35%
548	-	-	-	-	9.17%	3.31%	1.72%	0.29%



Table 6.5: Percentage still awaiting elective admission at 92 days  
BY specialty (England)

Specialty *	'time-since-enrolment' of those admitted 01.07 to 31.12.94		'time-to-admission' of those listed at 30.09.94		'time-to-admission' of those listed at 30.09.94		'time-since-enrolment' of those censused at midnight 30.09.94	
	(HES)	Rank	$(I_x^{upper})$	Rank	$(I_x^{lower})$	Rank	(KH07)	Rank
Ophthalmology	46.96	11	56.24	9	51.04	10	57.24	9
Trauma & Orthopaedics	46.81	10	61.65	11	55.01	11	60.36	10
ENT	45.07	9	57.28	10	49.14	9	54.53	6
Plastic & Burns Surgery	37.35	8	50.09	7	41.80	7	60.49	11
Oral Surgery	35.92	7	52.61	8	44.71	8	57.03	8
Urology	33.71	6	47.99	6	34.84	6	50.02	5
Cardiothoracic Surgery	27.46	5	36.72	4	33.77	5	56.59	7
General Surgery	25.95	4	41.78	5	31.14	4	49.60	4
Cardiology	25.76	3	36.61	3	30.92	3	41.61	3
Obs & Gynae	22.29	2	36.35	2	26.49	2	41.07	2
General Medicine	5.21	1	18.69	1	7.41	1	21.26	1
<b>All Specialties (999)</b>	<b>25.32</b>		<b>40.57</b>		<b>33.32</b>		<b>51.95</b>	

\* The eleven specialties which contribute the first 90% of those at-risk of elective admission

Table 6.6: Percentage still awaiting elective admission at 365 days  
BY specialty (England)

Specialty *	'time-since-enrolment' of those admitted 01.07 to 31.12.94		'time-to-admission' of those listed at 30.09.94		'time-to-admission' of those listed at 30.09.94		'time-since-enrolment' of those censused at midnight 30.09.94	
	(HES)	Rank	$(I_x^{upper})$	Rank	$(I_x^{lower})$	Rank	(KH07)	Rank
Plastic & Burns Surgery	10.77	11	19.34	9	14.93	10	11.07	11
Trauma & Orthopaedics	9.51	10	23.50	11	17.59	11	7.27	10
Ophthalmology	8.83	9	15.75	8	11.64	8	4.99	5
Oral Surgery	6.96	8	20.28	10	13.68	9	6.74	9
ENT	6.14	7	13.46	7	8.68	7	4.60	4
Urology	5.59	6	10.69	4	6.90	4	6.35	8
General Surgery	4.67	5	13.01	6	7.82	5	6.07	7
Cardiothoracic Surgery	4.41	4	12.01	5	8.31	6	5.65	6
Obs & Gynae	2.24	3	8.11	3	3.72	2	3.98	3
Cardiology	2.06	2	7.32	2	3.95	3	2.55	2
General Medicine	0.47	1	4.12	1	0.97	1	1.39	1
<b>All Specialties (999)</b>	<b>4.22</b>		<b>14.79</b>		<b>9.38</b>		<b>5.82</b>	

\* The eleven specialties which contribute the first 90% of those at-risk of elective admission

Table 6.7: Proportion of 'waits' ending in admission i.e., the likelihood of 'having been admitted', between 1 July and 31 December 1994 inclusive BY specialty (England)

Specialties (1)	KH06 admissions (2)	Competing events * (3)	$p(\infty) = 2/(2+3)$ (4)	${}_3q_0^{\text{admissions}}$ (5)	Rank (6)	${}_3q_0 = {}_3q_0^{\text{admissions}} \times p(\infty)$ (7)	Rank (8)
General Surgery	361,434	121,832	0.7479	0.7405	4	0.5538	5
Urology	141,187	47,484	0.7483	0.6629	6	0.4960	6
Trauma & Orthopaedics	184,464	101,513	0.6450	0.5319	10	0.3431	11
ENT	149,811	59,382	0.7161	0.5493	9	0.3934	10
Ophthalmology	131,535	44,184	0.7486	0.5304	11	0.3971	9
Oral Surgery	72,176	33,256	0.6846	0.6408	7	0.4387	8
Plastic & Burns Surgery	51,320	21,367	0.7060	0.6265	8	0.4423	7
Cardiothoracic Surgery	16,989	3,199	0.8415	0.7254	5	0.6104	3
General Medicine	84,782	15,543	0.8451	0.9479	1	0.8011	1
Cardiology	30,624	6,418	0.8267	0.7424	3	0.6137	2
Obstetrics & Gynaecology	248,670	69,461	0.7817	0.7771	2	0.6075	4
<b>All Specialties (999)</b>	<b>1,665,747</b>	<b>558,978</b>	<b>0.7487</b>	<b>0.7468</b>		<b>0.5591</b>	

\* Estimated as the number removed, self-deferred, failing-to-attend or suspended on administrative grounds

Table 6.8: Internal consistency of KH06, KH07A and KH07 returns for period 1 July to 31 December 1994 inclusive  
Trauma & Orthopaedics BY hospital (South Thames Region)

Code	Entering the group 'at-risk' of admission (E)				Error of Closure E-L (% = [E-L]/E*100)	Leaving the group 'at-risk' of admission (L)						Censused 31.12.94 [KH07]
	Censused 30.06.94 [KH07]	'Decisions- to-admit' [KH06]	'Reset-to- zero' *	'Re- instated' †		Admitted [KH06]	Removed [KH06]	Self-deferred [KH07A]	Failed [KH06]	Medic. Defrrd	Suspended [KH06]	
	RA1	1,025	1,319	240		0	-57 ( -2.2%)	1,027	240	233	7	
RA2	1,120	865	141	0	-89 ( -4.2%)	706	219	138	3	-	0	1,149
RAX	741	931	122	0	-2 ( -0.1%)	751	187	121	1	-	0	736
RAZ	975	978	110	0	-30 ( -1.5%)	948	144	104	6	-	0	891
RCY	0	216	18	0	-781 (-334%)	204	4	0	18	-	0	789
RDL	1,111	1,661	89	0	-20 ( -0.7%)	976	632	49	40	-	0	1,184
RDM	1,659	1,272	19	0	0 ( 0.0%)	1,012	193	9	10	-	0	1,726
RDR	73	34	3	0	2 ( 2.0%)	24	13	1	2	-	0	68
RDU	1,140	818	223	0	-54 ( -2.5%)	675	139	219	4	-	0	1,198
RDV	1,128	1,133	150	0	-31 ( -1.3%)	764	158	148	2	-	0	1,370
RG1	668	862	17	0	131 ( 8.5%)	611	29	4	13	-	0	759
RG2	805	573	85	0	-179 (-12.2%)	674	87	72	13	-	0	796
RG3	1,543	1,194	482	100	-54 ( -1.6%)	949	447	427	55	-	100	1,395
RGU	1,003	935	82	0	-65 ( -3.2%)	561	279	0	82	-	0	1,163
RGV	497	616	60	44	-2 ( -0.2%)	627	81	23	37	-	44	407
RGW	540	564	97	9	0 ( 0.0%)	372	189	45	52	-	9	543

Contd 6.8: Internal consistency of KH06, KH07A and KH07 returns for period 1 July to 31 December 1994 inclusive

Trauma & Orthopaedics BY hospital (South Thames Region)

Code	Entering the group 'at-risk' of admission (E)				Error of Closure E-L (% = [E-L]/E*100)	Leaving the group 'at-risk' of admission (L)						
	Censused 30.06.94 [KH07]	'Decisions- to-admit' [KH06]	'Reset-to- zero' *	'Re- instated' †		Admitted [KH06]	Removed [KH06]	Self-deferred [KH07A]	Failed [KH06]	Medic. Defrrd	Suspended [KH06]	Censused 31.12.94 [KH07]
	RGX	0	180	2		0	-126 (-69.2%)	180	26	2	0	-
RGZ	691	858	94	72	0 ( 0.0%)	631	185	94	0	-	72	733
RHE	893	549	85	0	3 ( 0.2%)	430	85	76	9	-	0	924
RHG	315	450	127	0	-21 ( -2.4%)	398	97	117	10	-	0	291
RHH	975	877	100	0	13 ( 0.7%)	712	155	100	0	-	0	972
RJ1	1,391	1,369	198	97	-40 ( -1.3%)	933	528	164	34	-	97	1,339
RJ2	873	1,290	438	0	139 ( 5.3%)	1,054	121	293	145	-	0	849
RJ6	1,111	1,122	388	0	-73 ( -2.8%)	901	254	359	29	-	0	1,151
RJ7	502	800	230	0	-76 ( -5.0%)	611	200	195	35	-	0	567
RJZ	850	182	12	0	5 ( 0.5%)	200	36	4	8	-	0	791
RN7	1,041	470	295	0	-134 ( -7.4%)	206	163	276	19	-	0	1,276
RPA	1,078	860	349	0	-205 ( -9.0%)	847	164	334	15	-	0	1,132
RPC	24	70	11	2	-6 ( -6.0%)	51	14	6	5	-	2	35
RPD	969	730	27	0	0 ( 0.0%)	628	65	27	0	-	0	1,006
RPF	1,531	2,158	206	0	-10 ( -0.3%)	1,182	868	76	130	-	0	1,649
RPL	1,489	1,186	157	0	-5 ( -0.2%)	946	268	157	0	-	0	1,466

Contd 6.8: Internal consistency of KH06, KH07A and KH07 returns for period 1 July to 31 December 1994 inclusive  
Trauma & Orthopaedics BY hospital (South Thames Region)

Code	Entering the group 'at-risk' of admission (E)				Error of Closure E-L (% = [E-L]/E*100)	Leaving the group 'at-risk' of admission (L)						
	Censused 30.06.94 [KH07]	'Decisions- to-admit' [KH06]	'Reset-to- zero' *	'Re- instated' †		Admitted [KH06]	Removed [KH06]	Self-deferred [KH07A]	Failed [KH06]	Medic. Defrrd	Suspended [KH06]	Censused 31.12.94 [KH07]
RPR	1,446	903	97	0	-72 ( -2.9%)	650	189	87	10	-	0	1,582
RPS	680	721	81	0	-4 ( -0.3%)	602	101	81	0	-	0	702

\* Estimated as the number who self-deferred or failed-to-attend for admission to hospital that quarter

† Estimated as the number temporarily suspended or deferred on medical grounds that quarter

Note: The numbers in italics contribute nothing to the difference between E and L so the 'error of closure' is really a comparison of columns 2 & 3 with columns 7, 8 & 13.

Table 6.9: Ratio of valid \* elective episodes (HES) to KH06 admissions from Trauma & Orthopaedic waiting lists in South Thames Region  
BY quarter of admission BY hospital

Hospital	1994 Q4	1994 Q3	1994 Q2	1994 Q1	1993 Q4	1993 Q3	1993 Q2	1993 Q1	1992 Q4	1992 Q3
RA1	1.0437	1.0649	1.0587	0.9907	1.0030	0.9975	0.9973	1.0073	1.0242	1.0087
RA2	1.0169	1.0370	1.0571	1.0400	1.0453	1.0075	0.9916	1.0051	1.0053	1.0087
RAV	-	-	-	-	-	-	-	-	-	-
RAX	0.9968	0.9977	1.0155	1.0062	1.0038	1.0000	0.9960	0.9960	1.0038	0.9970
RAZ	1.0181	1.0079	1.0051	1.0134	1.0114	1.0000	1.0000	1.0061	1.0000	0.9975
RCY	2.1471	2.1667	-	-	-	-	-	-	-	-
RDL	1.0242	1.0291	1.0411	1.0288	1.5556	1.0569	1.0807	1.0384	1.0413	0.8889
RDM	0.9498	0.9451	0.9351	0.9506	0.9281	0.9310	0.9177	0.9676	0.9449	1.0629
RDR	1.2500	1.0833	1.2500	1.6667	1.0000	3.0000	1.3333	1.0000	1.2000	1.0909
RDU	1.2738	1.1921	1.2042	1.0267	1.1767	1.0000	1.0034	1.0000	1.0042	1.0000
RDV	1.0000	1.0045	1.0000	1.0022	0.9968	1.0000	1.0114	1.0322	1.0054	1.0024
RG1	0.9645	0.9468	0.9468	0.9130	0.9652	1.0317	1.0640	-	-	-
RG2	1.0095	1.0140	1.0583	1.3255	1.1569	1.3673	1.6904	-	-	-
RG3	1.2140	1.1102	1.1685	1.2405	1.2753	1.2959	1.2479	-	-	-
RGU	1.0664	1.0909	1.1474	1.3843	1.1204	1.1341	1.3054	-	-	-
RGV	0.8766	0.9260	0.8604	0.9674	0.8016	0.8011	0.8885	-	-	-
RGW	0.9385	1.0000	1.1250	1.3363	1.4956	1.5405	0.9439	-	-	-
RGX	1.0106	0.9884	1.0000	0.9126	1.0000	1.0238	1.1429	-	-	-

Contd 6.9: Ratio of valid \* elective episodes (HES) to KH06 admissions from Trauma & Orthopaedic waiting lists in South Thames Region

BY quarter of admission BY hospital

Hospital	1994 Q4	1994 Q3	1994 Q2	1994 Q1	1993 Q4	1993 Q3	1993 Q2	1993 Q1	1992 Q4	1992 Q3
RGZ	0.9777	1.0063	0.9667	1.0000	1.0073	1.0000	0.9974	-	-	-
RHE	0.9952	0.9955	1.0000	1.0045	0.9894	1.0084	0.9935	-	-	-
RHG	0.9943	0.9910	1.0169	1.0185	1.0105	1.0000	1.0000	-	-	-
RHH	1.0052	1.0061	1.0066	1.0091	1.0028	1.0066	1.0210	-	-	-
RJ1	0.8753	0.9706	1.0022	1.0975	1.0580	1.9297	2.5158	-	-	-
RJ2	0.9615	0.7058	0.8939	1.3508	0.8065	0.9415	1.1843	-	-	-
RJ6	1.0510	1.0822	1.0579	1.0039	0.9741	0.9661	1.0204	-	-	-
RJ7	1.0057	1.0038	1.0066	1.0000	1.0141	0.9926	1.0224	-	-	-
RJZ	2.5000	3.1100	1.0069	2.9278	2.6804	1.0640	0.9920	-	-	-
RN7	3.0620	4.8442	2.5399	-	-	-	-	-	-	-
RPA	1.0724	1.0464	1.0695	-	-	-	-	-	-	-
RPC	1.0000	1.0000	1.0000	-	-	-	-	-	-	-
RPD	1.0668	1.0951	1.0930	-	-	-	-	-	-	-
RPF	1.1912	1.2222	1.2312	-	-	-	-	-	-	-
RPL	1.1324	1.1033	1.1166	-	-	-	-	-	-	-
RPR	0.9971	1.0033	0.9962	-	-	-	-	-	-	-
RPS	1.0061	1.0181	1.0061	-	-	-	-	-	-	-

\* Episodes where the date of enrolment was neither blank nor set to '15 Oct 1582'



Table 6.10: Proportion of Trauma & Orthopaedic (110) 'waits' ending in elective admission i.e., the likelihood of 'having been admitted', between 1 July and 31 December 1994 inclusive BY hospital (South Thames Region)

Code	Name of Hospital	Admitted (1)	Competing Events (2)	$p(\infty) =$ $1/(1+2)$ (3)	${}_3q_0^{\text{admissions}}$ Rank (4)	Rank (5)	${}_3q_0 =$ $p(\infty) \times {}_3q_0^{\text{admissions}}$ (6)	Rank (7)
RG1	Mid Kent Healthcare NHS Trust	611	46	0.9300	0.5243	8	0.4876	3
RCY	Ashford Hospital NHS Trust	204	22	0.9027	0.4658	16	0.4205	5
RPD	Kent and Sussex Weald NHS Trust	628	92	0.8722	0.4688	15	0.4089	6
RGX	Eastbourne & County Healthcare NHS Trust	180	28	0.8654	0.6316	3	0.5466	1
RDM	Hastings & Rother NHS Trust	1,012	212	0.8268	0.4020	24	0.3324	12
RJZ	King's Healthcare NHS Trust	200	48	0.8065	0.3627	31	0.2925	18
RG2	Greenwich Healthcare NHS Trust	674	172	0.7967	0.3909	25	0.3114	16
RAZ	St. Helier's NHS Trust	948	254	0.7887	0.4304	20	0.3395	11
RGV	Thanet Healthcare NHS Trust	627	185	0.7722	0.5136	10	0.3966	8
RPS	Mid-Sussex NHS Trust	602	182	0.7679	0.3699	28	0.2840	21
RHH	East Surrey Hospital and Community Healthcare NHS Trust	712	255	0.7363	0.3674	30	0.2705	22
RHE	Crawley and Horsham NHS Trust	430	170	0.7167	0.2287	34	0.1639	31
RDV	St. Peter's Hospital NHS Trust	764	308	0.7127	0.3693	29	0.2632	26
RAX	Kingston Hospital NHS Trust	751	309	0.7085	0.4814	12	0.3411	10
RPR	The Royal West Sussex NHS Trust	650	286	0.6944	0.2351	33	0.1633	33
RPL	Worthing and Southlands Hospitals NHS Trust	946	425	0.6900	0.4184	22	0.2887	20
RA1	Epsom Health Care NHS Trust	1,027	480	0.6815	0.4239	21	0.2889	19

Contd 6.10: Proportion of Trauma & Orthopaedic (110) 'waits' ending in elective admission i.e., the likelihood of 'having been admitted',  
between 1 July and 31 December 1994 inclusive BY hospital (South Thames Region)

Code	Name of Hospital	Admitted (1)	Competing Events (2)	$p(\infty) =$ $1/(1+2)$ (3)	${}_3q_0^{\text{admissions}}$ (4)	Rank (5)	${}_3p(\infty) \times {}_3q_0^{\text{admissions}}$ (6)	Rank (7)
RA2	The Royal Surrey County & St. Luke's Hospital Trust	706	360	0.6623	0.3734	27	0.2473	28
RPC	The Queen Victoria Hospital NHS Trust	51	27	0.6538	0.8125	1	0.5312	2
RJ2	Lewisham Hospital NHS Trust	1,054	559	0.6534	0.4098	23	0.2678	24
RDU	Frimley Park Hospital NHS Trust	675	362	0.6509	0.4935	11	0.3212	14
RGZ	Queen Mary's Sidcup NHS Trust	631	351	0.6426	0.6867	2	0.4413	4
RHG	Richmond, Twickenham & Roehampton Healthcare NHS Trust	398	224	0.6399	0.6232	4	0.3988	7
RPA	Medway NHS Trust	847	513	0.6228	0.5495	5	0.3422	9
RGU	Brighton Health Care NHS Trust	561	361	0.6085	0.5361	6	0.3262	13
RDR	South Downs	24	16	0.6000	0.2727	32	0.1636	32
RJ7	St. George's Healthcare NHS Trust	611	430	0.5869	0.5338	7	0.3133	15
RJ6	Mayday Health Care NHS Trust	901	642	0.5839	0.4604	18	0.2688	23
RDL	Eastbourne Hospitals NHS Trust	976	721	0.5751	0.5231	9	0.3008	17
RGW	Kent and Canterbury Hospitals NHS Trust	372	295	0.5577	0.4795	14	0.2674	25
RJ1	Guy's and St. Thomas' NHS Trust	933	823	0.5313	0.4642	17	0.2466	29
RPF	South Kent Hospitals NHS Trust	1,182	1,074	0.5239	0.4803	13	0.2516	27
RG3	Bromley Hospitals NHS Trust (Bromley Acute)	949	1,029	0.4798	0.4591	19	0.2203	30
RN7	Dartford and Gravesham NHS Trust	206	458	0.3102	0.3818	26	0.1184	34

Survival analysis and queuing discipline: new light on the synthetic cohort?

**Summary**

Aim

To show that exact lifetables make full use of all the available data and give identical results whether we count lifelines 'horizontally' or 'vertically'.

Method

A period lifetable was constructed for a synthetic cohort using 'horizontal' counts of the number of lifelines and the number of events at each 'time-since-enrolment'. Another period lifetable was constructed for the same synthetic cohort using 'vertical' counts of the number of lifelines sharing the same position in the queue and of the number of events occurring at particular queuing positions at each date and time since enrolment.

Results

The two approaches gave exactly the same cumulative likelihood of 'first-selection' among those at-risk which was smaller than the cumulative proportion 'first-selected' at every 'time-since-enrolment'.

Conclusion

If we do not use period lifetable techniques, we wrongly estimate the cumulative likelihood of the event of interest. We are also guilty of analysing waiting times without taking queuing position into account.

**Introduction**

Background

In chapter 5, we used aggregate data to construct a period lifetable for the English waiting list, 1 July to 31 December 1994. In the absence of numbers for each exact 'time-since-enrolment', we used aggregate counts of elective 'admissions' and of competing events which fell within three month waiting time categories and were generated by cohorts of patients enrolled over three month calendar periods. We used data collected 'vertically' as well as data collected 'horizontally'. Ignorant of the number at-risk 3 months, 6 months, 9 months etc after enrolment, we combined the numbers still at-risk of elective admission from each waiting time category at midnight, 30 September 1994, with cohort and category-specific counts of 'admissions' between 1 July and 31 December 1994. And we combined individual 'times-to-admission' with the rank order of 'times-since-enrolment' within each waiting time category. We estimated the conditional likelihoods of elective admission assuming that competing events precede 'admission' and then estimated it again assuming that elective 'admissions' precede competing events. Although the data used in chapter 5 left a lot to be desired (chapter 6), there was nothing inherently wrong with the method.

In this chapter, we compare two estimates of the cumulative likelihood of not experiencing an event of interest ( $S(t)$ ) by each 'time-since-enrolment'. The Kaplan-Meier estimate<sup>1</sup> counts lifelines horizontally e.g., the number still awaiting 'first-selection' at each 'time-since-enrolment' between 1 July and 31 December 1994, and it calculates the instantaneous risk ( $h(t)$ ) as the ratio of lifelines ending in 'first-selection' to the number of lifelines at-risk. The 'queuing position' estimate counts lifelines vertically e.g., the number still awaiting 'first-selection' at the start of each new date from 1 July to 31 December 1994, and it calculates instantaneous risk as the ratio of lifelines ending in 'first-selection' to the number of lifelines at-risk with the same 'time-since-enrolment' on each date, combined over the 184 dates of interest. The queuing position estimate takes analysis of period effects to its logical conclusion by allowing us to ask how the survival function ( $S(t)$ ) varies from one calendar date to the next.

### Objectives

This chapter uses lexis diagrams to argue that horizontal and vertical methods ought to give identical results where the number of complete days since enrolment are measured in terms of the number of changes of date since enrolment. It develops one set of procedures which give the horizontal counts required to produce a period Kaplan-Meier estimate and a second set which produce the vertical counts of lifelines required by the queuing position estimate. It confirms the exact equivalence of the results produced under the two methods and explores the relationship between the instantaneous risk of 'first-selection' and an assessment of queuing discipline.

### **Materials & Methods**

#### Materials

Details of entries on the Orthopaedic waiting list at Kingston Hospital NHS Trust (RAX) between 1 July and 31 December 1994 are held electronically on the Patient Administration System<sup>2</sup>. The KH06, KH07A and KH07 returns describe this waiting list under one set of official definitions at 30 September and 31 December 1994<sup>3</sup> and the *Hospital Episode Statistics 1994/95*<sup>4</sup>, compiled at a much later date, provide an alternative description under a different set of definitions.

No attempt was made to reconstruct patient waiting times using either of the official definitions. Instead, attention was restricted to the interval between the 'decision-to-admit' to the waiting list and the first occasion when the patient was selected to be offered a date for admission to hospital, termed the 'first-active-wait'. On rare occasions, the first thing that happens to a patient is that they are temporarily or permanently removed from the waiting list and these are viewed as competing events. The 'decision-to-admit' to the waiting list and the decision to offer a date for admission to hospital are made at the clinician's behest<sup>5,6</sup>. As a result, the factors which determine the length of the 'first-active-wait' and the cumulative likelihood of not being 'first-selected' should tell us something about clinical decision-making.

The Patient Information Database<sup>7</sup> was used to copy three pieces of information about each entry on the waiting list namely the date the initial entry was made, the date the status of the entry first changed and the

status of the entry as a result of that change. There were 1,391 entries where at least part of the 'first-active-wait' fell between 1 July and 31 December 1994 inclusive. 883 of these ended in 'first-selection' between 1 July and 31 December 1994 and another 39 in temporary or permanent removal from the waiting list i.e., the unconditional likelihood of having been 'first-selected' was  $p(\infty) = 95.8\%$ .

The horizontal method: aggregating data on 'time-since-enrolment'

Given a variable which measures length of 'time-since-enrolment' and another which indicates whether or not the event of interest occurred, the Advanced Statistics module of the Statistical Package for the Social Sciences<sup>8</sup> rapidly produces Kaplan-Meier survival functions for enrolment cohorts. Unfortunately, the module does not allow for left censoring and therefore cannot be used to produce a period lifetable; it would include the length of 'time-since-enrolment' prior to 1 July 1994 as though capable of 'first-selection' between 1 July and 31 December 1994. Instead, we calculate the instantaneous risk of 'first-selection' and the cumulative likelihood of surviving 'first-selection' at the end of the lengthy process of data aggregation described below ('aprax.sps' and 'cprax.sps', appendix 7):

1. SPSS was used to identify every record where day zero of the 'first-active-wait' fell between 1 July and 31 December 1994 and to create a variable (risk000) which indicated whether day zero's exposure ended in 'first-selection' (1), a competing event (0) or left the patient still at-risk of 'first-selection' (0). (This procedure had to be repeated for each and every day up to the longest 'time-since-enrolment' of interest i.e., 371 complete days.)
2. SPSS was then used to identify every record where any part of the 'first-active-wait' fell between 1 July and 31 December 1994 and to aggregate them, creating three new variables for each 'risk' variable. The first counted the number of non-missing values ( $n000=N(\text{risk000})$ ), the second counted the number of 'first-selections' ( $a000=\text{SUM}(\text{risk000})$ ) and the third gave the mean outcome of the day's exposure ( $m000=\text{MEAN}(\text{risk000})$ ) i.e., the instantaneous risk of 'first-selection'.
3. The aggregated data was exported to an Excel<sup>9</sup> spreadsheet where the row of aggregate counts and columns of variable names were transposed and rearranged to provide the first four columns in table 7.1.
4. Step 1 was repeated creating a variable (crisk000) which indicated whether the day's exposure ended in a competing event (1), in 'first-selection' (0) or left the patient still at-risk of a competing event. SPSS was used to identify every record where any part of the 'first-active-wait' fell between 1 July and 31 December 1994 and to aggregate them, creating one new variable which summed the outcome of the day's exposure to the risk of a competing event ( $c000=\text{SUM}(\text{crisk000})$ ). Step

3 was then repeated providing a count of competing events for each time-since-enrolment (column 5, table 7.1).

5. The two spreadsheets were taken back into SPSS, merged and returned to Excel as a single spreadsheet where it was sorted in ascending order of 'time-since-enrolment' and descending order of mean outcome of exposure. Column 6 was then calculated as the product of the complement of the instantaneous risk of 'first-selection' i.e., as  $l_x = \prod(1 - {}_1A_{t-1}/N_{t-1})$  and plotted in figure 7.1. (Merging the two spreadsheets gives two rows of  $l_x$  values for each 'time-since-enrolment' and allows us to represent each 'first-selection' by a stepwise decrement in  $S(t)$ .)

Figure 7.1: Three estimates of the cumulative likelihood of 'surviving' first-selection from the Orthopaedic waiting list at Kingston Hospital NHS Trust between 1 July and 31 December 1994

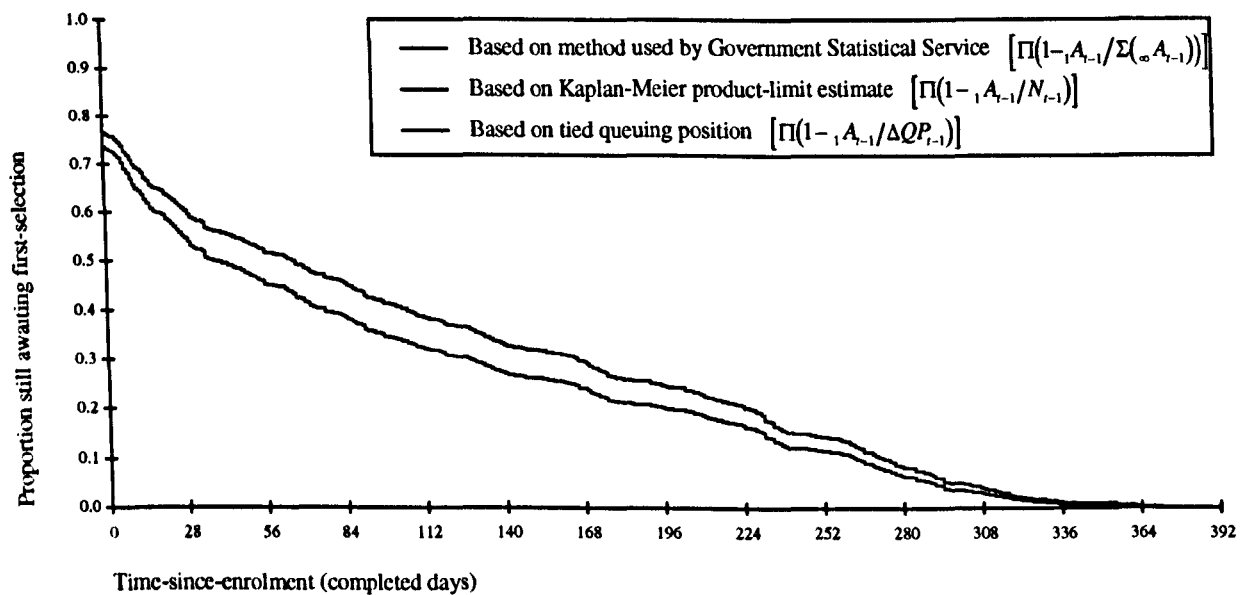

The vertical method: aggregation on date of enrolment and on date of interest

The vertical method ranks lifelines in ascending order of the date of enrolment and therefore in descending order of length of 'time-since-enrolment'. As a result, there are several ways of estimating the number of lifelines with 'times-since-enrolment' tied at time  $t$ . We can count the number censused at the start of the day ( $P_{t-1,t}^s$ ) or we can add the number of lifelines ending in 'first-selection' ( ${}_1A_t$ ) or a competing event ( ${}_1C_t$ ) during the course of the day to the number censused at the end of the day ( $P_{t,t+1}^e$ ). Or it can be obtained as the number of lifelines with a 'time-since-enrolment' between  $t$  and  $t+1$  between midnight

at the start of date  $d$  and midnight at the end of date  $d$  i.e., as the number of tied positions in the waiting list queue between  $QP_t$  and  $QP_{t+1}$  on day  $d$ .

Figure 7.2: Three different ways of counting the numbers at-risk of first-selection  $t$  days after enrolment on the waiting list

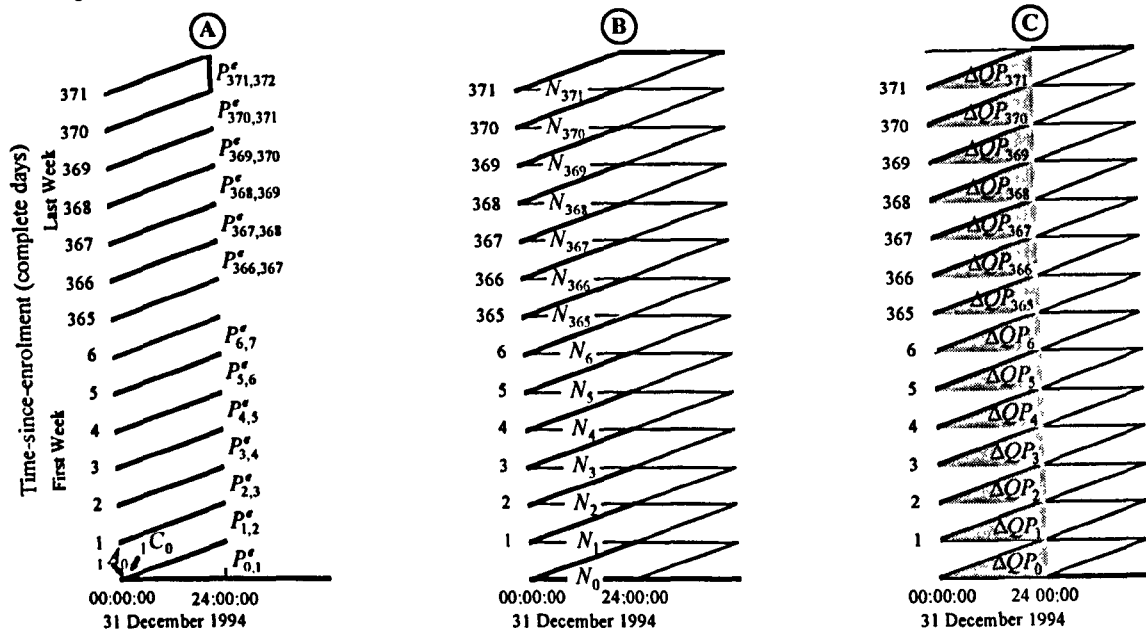

$$S(t) = \left[ \prod (1 - {}_1A_{t-1} / ({}_1A_{t-1} + C_{t-1} + P_{t-1,t}^e)) \right]$$

$$S(t) = \left[ \prod (1 - {}_1A_{t-1} / N_{t-1}) \right]$$

$$S(t) = \left[ \prod (1 - {}_1A_{t-1} / \Delta QP_{t-1}) \right]$$

The steps adopted were as follows ('aqrax.sps', appendix 7):

1. All records with a 'first-active-wait' on 1 July 1994 were selected in SPSS and ranked in ascending order of their date of enrolment on the waiting list. A variable was created which recorded the rank of each entry where ties i.e., those with the same date of enrolment, were given the same high value (h010794). A second variable was created which gave tied entries the same low value (l010794). And a third variable was created which reported the high value only where the 'first-active-wait' ended in 'first-selection' that day (a010794). (This procedure had to be repeated for each of the 184 calendar dates in the period of interest.)
2. All records with a 'first-active-wait' falling between 1 July and 31 December 1994 were selected and aggregated using the date of enrolment as break variable. This procedure was used to produce three separate tables of data:
  - a) The first presented the mean rank of those enrolled on the waiting list on the same day where tied 'times-since-enrolment' were given the same high value e.g., mh0107=MEAN(h010794);
  - b) the second presented the mean rank of those enrolled on the same day where tied 'times-since-enrolment' were each given the same low value e.g., ml0107=MEAN(l010794) and

- c) the third presented the number enrolled on the same day and ‘first-selected’ on the date of interest e.g.,  $a0107 = \text{SUM}(a010794)$ .

Each of these was merged with a file which contained a complete series of dates from 1 July to 31 December 1994 then aggregated a second time to provide a single set of variables against each date of enrolment and saved as a spreadsheet. Table 7.3a (appendix 7) shows part of the table of mean high ties. The unshaded rows of empty cells represent dates on which no-one was recruited to the waiting list and the cells shaded grey are those which have to be deleted, moving values up the table so that rank in the queue at each ‘time-since-enrolment’ can be compared across the 184 dates of interest (table 7.3b, appendix 7).

3. We calculated  $QP_{t:d} - QP_{t+1:d}$  as the number of tied ranks for each date and time since enrolment (table 7.2). We summed  ${}_1A_{t:d}$  and we summed  $QP_{t:d} - QP_{t+1:d}$  across the 184 dates in the period of interest and then calculated the instantaneous risk of ‘first-selection’ at time  $t$  in a fashion exactly analogous to the horizontal method:

$$\frac{{}_1A_t}{N_t} = \frac{\sum {}_1A_{t:d}}{\sum (QP_{t:d} - QP_{t+1:d})}$$

4. ‘Time-since-enrolment’ and the instantaneous risk of ‘first-selection’ at time  $t$  were exported to SPSS and merged with a file which contained a complete series of ‘times-since-enrolment’. Back in Excel, the merged file was sorted in ascending order of ‘time-since-enrolment’ and in descending order of the instantaneous risk of ‘first-selection’. Finally, we calculated the cumulative likelihood of surviving ‘first-selection’  $S(t)$  so that each ‘first-selection’ could be represented by a stepwise decrement in figure 7.1.

## Results

Table 7.1 reports the Kaplan-Meier estimate of  $S(t)$  for the synthetic cohort listed between 1 July and 31 December 1994. In an enrolment cohort, the numbers at-risk should decrease from one ‘time-since-enrolment’ to the next by an amount exactly equal to the number of ‘first-selections’ and competing events observed. But this need not be the case in a synthetic cohort. Indeed, the numbers at-risk may even show an increase ( $N_3 = 726$ ,  $N_4 = 734$ ) where the instantaneous risk of ‘first-selection’ is very small ( $M_3 = 0.0028$ ) and where the numbers recruited are very variable. We would only expect numerical consistency in a synthetic cohort or period lifetable if the population were stationary.

Figure 7.1 compares the survival functions ( $S(t)$ ) calculated using horizontal and vertical methods and confirms that the two step functions are exactly identical. And the cumulative proportion not ‘first-selected’ (among those experiencing ‘first-selection’) confirms that the method used by the Government Statistical Service overestimates the cumulative likelihood of ‘first-selection’ at every ‘time-since-enrolment’ on the list.



## Discussion

### Equivalence: when a survivorship ratio equals the conditional likelihood of survival

When we calculate ‘time-since-enrolment’, we count the number of changes of date survived. And if only the date is recorded, we are forced to make some assumption about the distribution of enrolments over the 24 hour period. In practice, patients with the same date of enrolment are assumed to have been enrolled together at the very start of the day in question i.e., at 00:00:00 hours. Locating the time of enrolment and of events such as ‘first-selection’ in this fashion allows us to view each change of date as another 24:00:00 hours on the waiting list. The approach admits that we have no information on the actual sequence of enrolment each day and avoids unwarranted assumptions about that part of each 24:00:00 hours since enrolment spent either side of midnight. Although enrolment and ‘first-selection’ normally take place during office hours rather than just after midnight, the approach has important benefits for the analysis of the likelihood of ‘first-selection’.

Figure 7.2A shows the sort of data available: we know the numbers enrolled on each date and the numbers ending in ‘first-selection’ or a competing event  $t$  changes of date later. And if the population were closed, the chance of surviving the  $t$ ’th change of date would be called a survivorship ratio rather than a conditional likelihood of surviving the event. Figure 7.2B is analogous to figure 2.1 and shows the data needed to calculate the conditional likelihood of ‘first-selection’ for each ‘time-since-enrolment’ on the list. Unfortunately, this requires information on the exact time as well as on the exact date of each enrolment and of each event so that ‘first-selections’ and competing events may be identified as following or preceding the change of date. However when dates of enrolment, ‘first-selection’ and competing events are assumed to occur immediately after the change of date, the ratios calculated from A will be the same as those calculated from B or C. The entire exposure to the risk of ‘first-selection’ at time  $t$  and date  $d$  and all the events of interest are captured on the black diagonal lines of figure 7.2. As a result,

$$P_{t-1,t}^s = {}_1N_t = P_{t,t+1}^e + {}_1A_t + {}_1C_t = QP_t - QP_{t+1}.$$

### Equivalence: when event times are ranked within the set of ‘times-since-enrolment’

The Kaplan-Meier survival function is concerned with the rank order of event times within the overall distribution of times observed i.e., with the rank order of ‘times-to-first-selection’ within the set of ‘times-since-enrolment’. Where waiting times end in a competing event or an incomplete observation, we only need to know if the length of ‘time-since-enrolment’ equalled or exceeded the length of ‘time-to-first-selection’<sup>10</sup>. This allows a certain parsimony in data collection and allows inclusion of censored observations but is not particularly meaningful where we are concerned with enrolment cohorts. However, this changes when event times are sampled cross-sectionally and when interest shifts to the calendar period in which effects were observed.

At the start of any date of interest, the rank order of the dates of enrolment reflects the rank order of the ‘times-since-enrolment’ of those still at-risk and the queuing position of those ‘first-selected’ automatically reflects the rank order of event times within the set of ‘times-since-enrolment’ at-risk. Each event will

reflect the conditional likelihood of ‘first-selection’ among those enrolled together on the same date and still at-risk  $t$  days from enrolment so that the conditional likelihood of ‘first-selection’

$${}_1A_t/N_{t:d} = {}_1A_t/(QP_{t:d} - QP_{t+1:d}).$$

Figure 7.3: The cumulative likelihood of ‘surviving’ first-selection to any given position on the queue for elective Orthopaedic surgery at Kingston Hospital NHS Trust between 1 July and 31 December 1994

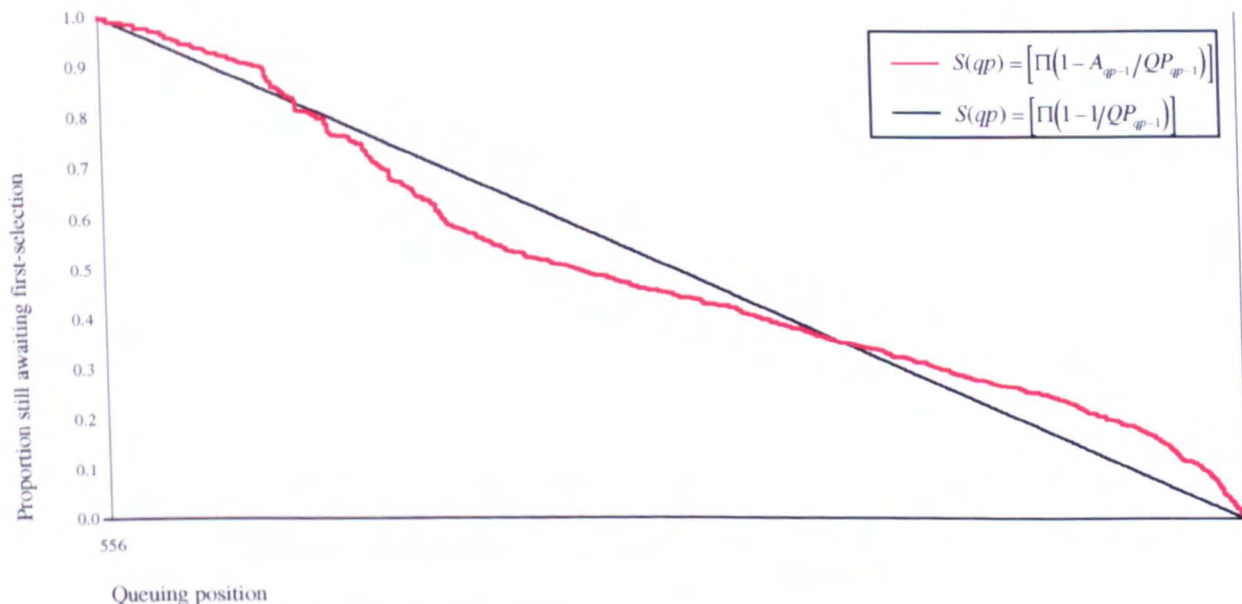

### Conclusions & recommendations

Figure 7.1 confirms that the Government Statistical Service method wrongly estimates the cumulative likelihood of ‘first-selection’ at every ‘time-since-enrolment’ suggesting that 63.99% of ‘first-selection’ occur within three months of enrolment when the true figure was 57.32%. It shows the sort of information lost by aggregating data on three month waiting time categories: 23.32% of those enrolled ‘went home’ from outpatients with a date ‘to-come-in’ to hospital while another 34% were ‘first-selected’ at some subsequent point during their first three months on the waiting list. And the exact equivalence of the horizontal and vertical methods indicates that when we analyse waiting times using the Government Statistical Service method, we ignore patients’ position in the queue.

Table 7.2 makes it clear that the data is very ‘lumpy’ with recruitment and ‘first-selection’ concentrated on certain calendar dates. Having identified position in the queue on the date and time of ‘first-selection’, we might take the analysis a step further by substituting ‘queuing position’ for ‘time-since-enrolment’ as a measure of individuals’ progress through the waiting list. This would allow us to ignore the timing and frequency of recruitment and ‘first-selection’ and would allow us to ask whether ‘first-selection’ has anything to do with position in the queue. Moreover, we would only need to know the position reached by

those experiencing the event of interest because our calculation of queuing position has already taken account of censored observations i.e., we could prepare figure 7.3 from event-based data if queuing position had been determined at an earlier stage in data-processing.

$S(qp) = \prod (1 - 1/QP_{qp-1})$  predicts the cumulative likelihood of surviving 'first-selection' to occupy any given position in the queue, assuming that the instantaneous risk of 'first-selection' is shared equally among all those at least as close to the top of the queue i.e., among all those occupying position 1 through to  $QP_{qp-1}$ . This shows the cumulative likelihood of surviving 'first-selection' where individuals are selected from the waiting list queue at random.  $S(qp) = \prod (1 - A_{qp-1}/QP_{qp-1})$  allows us to assess whether the observed likelihood of admission was 'consistent' with their position in the queue. We recommend that this approach be developed further before being used in earnest.

## References

1. Kaplan EL, Meier P. 'Nonparametric estimation from incomplete observations', *American Statistical Association Journal*, 53, 457-481 (1958). (Page 463.)
2. SMS United Kingdom Ltd. *A-UK Model Inpatient Application Waiting List. Release 5.0. Application Manual*, Shared Medical Systems Corporation, Basingstoke, 1992.
3. Department of Health, NHS Management Executive, Information Management Group. 'Patients awaiting elective admission', In: *The data manual: module 1: hospital services. Version 1.0*, Department of Health, Stanmore, 1992. Pages 5/15-5/18.
4. Department of Health. *Hospital Episode Statistics. Volume 3. Finished consultant episodes: waiting time of elective admissions by diagnosis and operation; injury/poisoning by external causes. ENGLAND: Financial Year 1994-95*, Government Statistical Service, 1996.
5. The Royal College of Surgeons of England. *Guidelines for the management of surgical waiting lists*, The Royal College of Surgeons, London, 1991. Section B, paragraph 3b and section D, paragraph 3a.
6. Churchill K, Howard J, Jayes R. *Managing waiting lists for in-patients and day cases*, Department of Health, Birmingham, 1990. Pages II/6, II/7.
7. Healthcare Computing Resources. *SCAN user guide. A comprehensive guide to the SCAN information management toolkit*, Healthcare Computing Resources, London, 1995.

8. Norušis MJ, SPSS Inc. 'Kaplan-Meier survival analysis', In: *SPSS Advanced Statistics 6.0*, SPSS Inc., USA, 1994. Pages 275-290.
9. Microsoft Corporation. *User's Guide 1. Microsoft Excel. Spreadsheet with Business Graphics and Database. Version 4.0 for Apple Macintosh Series or Windows Series*, Microsoft Corporation, USA, 1992. Pages 210-212.
10. Collett D. In: *Modelling survival data in medical research*, Chapman & Hall, London, 1994. Pages 19-21.

Table 7.1: An abridged PERIOD lifetable of the cumulative likelihood of 'surviving' first-selection from the Orthopaedic waiting list at Kingston Hospital NHS Trust (RAX) between 1 July and 31 December 1994 - prepared using the Kaplan-Meier assumption about tied event times

Time-since-enrolment ( $t$ complete days)	Number at-risk ( $N_t$ )	Number of first-selections ( ${}_1A_t$ )	Mean outcome of exposure ( $M_t = {}_1A_t/N_t$ )	Number of competing events ( ${}_1C_t$ )	$l_x = \prod(1 - {}_1A_{t-1}/N_{t-1})$
0	939	219 *	0.2332	0	1.0000
1	726	4	0.0055	0	0.7668
2	723	4	0.0055	0	0.7625
3	726	2	0.0028	0	0.7583
4	734	5	0.0068	0	0.7562
5	729	5	0.0069	0	0.7511
6	724	8	0.0110	0	0.7459
.	.	.	.	.	.
.	.	.	.	.	.
.	.	.	.	.	.
365	1	0	0.0000	0	0.0018
366	1	0	0.0000	0	0.0018
367	1	0	0.0000	0	0.0018

Contd 7.1: An abridged PERIOD lifetable of the cumulative likelihood of 'surviving' first-selection from the Orthopaedic waiting list at Kingston Hospital NHS Trust (RAX) between 1 July and 31 December 1994 - prepared using the Kaplan-Meier assumption about tied event times

Time-since-enrolment ( <i>t</i> complete days)	Number at-risk ( $N_t$ )	Number of first-selections ( ${}_1A_t$ )	Mean outcome of exposure ( $M_t = {}_1A_t/N_t$ )	Number of competing events ( ${}_1C_t$ )	$l_x = \prod(1 - {}_1A_{t-1}/N_{t-1})$
368	1	0	0.0000	0	0.0018
369	1	0	0.0000	0	0.0018
370	1	0	0.0000	0	0.0018
371	1	1	1.0000	0	0.0018
<b>Total</b>		<b>833</b>		<b>39</b>	

\* The large number of 'first-selections' on the day of enrolment probably reflects the practice of booking elective admission to hospital at the time of the 'decision-to-admit' to the waiting list.

Table 7.2: An abridged PERIOD lifetable of the cumulative likelihood of 'surviving' first-selection from the Orthopaedic waiting list at Kingston Hospital NHS Trust (RAX) between 1 July and 31 December 1994 - prepared using the number of tied queuing positions to estimate the number of 'first-active-waits' at-risk

Time-since-enrolment ( <i>t</i> complete days)	25/08/1994		1/09/1994		8/09/1994		16/09/1994		1 July to 31 December 1994		
	$\Delta QP_{(t,d)}$	${}_1A_{(t,d)}$	$\Delta QP_{(t,d)}$	${}_1A_{(t,d)}$	$\Delta QP_{(t,d)}$	${}_1A_{(t,d)}$	$\Delta QP_{(t,d)}$	${}_1A_{(t,d)}$	$\Delta QP_{(t,d)}$	${}_1A_{(t,d)}$	$l_x = \prod(1 - {}_1A_{t-1}/\Delta QP_{t-1})$
0	4	3	15	11	5	5	7	3	939	219	1.0000
1	0	0	2	0	6	0	3	0	726	4	0.7668
2	5	0	3	0	5	2	0	0	723	4	0.7625
3	10	0	0	0	9	0	8	0	726	2	0.7583
4	0	0	0	0	0	0	13	0	734	5	0.7562
5	0	0	0	0	0	0	0	0	729	5	0.7511
6	4	0	11	0	5	0	0	0	724	8	0.7459
.	.	.	.	.	.	.	.	.	.	.	.
.	.	.	.	.	.	.	.	.	.	.	.
.	.	.	.	.	.	.	.	.	.	.	.
365	0	0	0	0	0	0	0	0	1	0	0.0018
366	0	0	0	0	0	0	0	0	1	0	0.0018

Contd 7.2: An abridged PERIOD lifetable of the cumulative likelihood of 'surviving' first-selection from the Orthopaedic waiting list at Kingston Hospital NHS Trust (RAX) between 1 July and 31 December 1994 - prepared using the number of tied queuing positions to estimate the number of 'first-active-waits' at-risk

Time-since-enrolment ( <i>t</i> complete days)	25/08/1994		1/09/1994		8/09/1994		16/09/1994		1 July to 31 December 1994		
	$\Delta QP_{(t,d)}$	${}_1A_{(t,d)}$	$\Delta QP_{(t,d)}$	${}_1A_{(t,d)}$	$\Delta QP_{(t,d)}$	${}_1A_{(t,d)}$	$\Delta QP_{(t,d)}$	${}_1A_{(t,d)}$	$\Delta QP_{(t,d)}$	${}_1A_{(t,d)}$	$l_x = \prod(1 - {}_1A_{t-1}/\Delta QP_{t-1})$
367	0	0	0	0	0	0	0	0	1	0	0.0018
368	0	0	0	0	0	0	0	0	1	0	0.0018
369	0	0	0	0	0	0	0	0	1	0	0.0018
370	0	0	0	0	0	0	0	0	1	0	0.0018
371	0	0	0	0	0	0	0	0	1	1	0.0018
<b>Total</b>		<b>38</b>		<b>30</b>		<b>49</b>		<b>40</b>		<b>833</b>	



## Concluding remarks

### John Graunt and Edmund Halley

*"... This does not mean, however, that in the absence of reliable ... data it is worth while continuing the time-honoured precedents of examining and publishing data on the size and length of waiting lists. The absence of any source of valid information cannot transform meaningless statistics into a useful management tool."*

Sanderson HF. 'What's in a waiting list?', *BMJ*, 285, 1369 (1982).<sup>1</sup>

Current analyses of the 'times-since-enrolment' of those admitted electively resemble the approach pioneered by John Graunt in his *'Natural and Political Observations on the Bills of Mortality'* in 1662<sup>2</sup>. Graunt wanted to assess the likelihood of surviving to a particular age and used the Bills of Mortality as his primary source of information. He knew that Londoners fled the city to avoid the plague and estimated that immigration not only replaced the number lost to plague but was also sufficient to swell the population of London year on year. He had no information on the ages of the dead, on the numbers and ages of the living<sup>3</sup> or on the numbers and ages of those settling in London or removing from it. So in order to assess the likelihood of surviving to a particular age Graunt was obliged to assume that the population of London was stationary.

He began by deducing the 'ages-at-death' of those who died. He estimated the risk of death before the sixth birthday from causes of death where he believed under six-year-olds contributed most, if not all, the deaths observed. He attributed deaths caused by being 'aged' to the interval between the 76th and 80th birthdays and assumed that no one lived to celebrate their 80th birthday. He allocated the remaining risk to the intervening seventy years using an entirely arbitrary rule of thumb, seeking '*six mean proportional numbers ... because men do not die in exact proportions, nor in fractions*'<sup>2</sup>. He '*supposed that the rates of mortality were approximately independent of age through a long period of life*'<sup>4</sup>. In the absence of data on the 'times-since-enrolment' of KH06 admissions, we would have been obliged to adopt a similarly arbitrary approach were the 'times-since-enrolment' of valid elective episodes ruled inapplicable.

Edmund Halley<sup>5</sup> (1693) had a much better understanding of the nature of the stationary population. He criticized Graunt's deductions from the Bills of Mortality when the size of the population and the ages of those dying in London was unknown and when there were far more deaths than christenings and the effect of immigration and emigration was expected to be considerable. He drew attention to the similarity between the number of births and the number of deaths between 1687 and 1691 in the city of Breslau and attributed the shortfall in deaths (5.2%) to the enlistment of some citizens in the military. He believed that a closed population should become stationary and tested the extent to which the data for Breslau was consistent with such an assumption. Unfortunately, Halley's understanding of population dynamics has been missing from analyses of NHS waiting lists.

John Graunt failed to appreciate the sort of errors likely to arise from his assumption that the population of London was stationary although there was little else he could have done given the nature of the data available<sup>3</sup>. Halley set out to calculate an unbiased measure of survivorship but was obliged to make the stationary population assumption because his correspondent provided the wrong summary counts<sup>3</sup>. But the Government Statistical Service has not chosen to use lifetable methods like those pioneered by Halley and his successors despite having the data to do so. Instead the waiting list population is assumed to be stationary without having satisfied the acid test applied by Halley. And the Government Statistical Service has failed to publicize the sort of errors necessarily associated with the estimates obtained.

### Queuing priority

*“... changing priorities, and thus changing the queue discipline, will not affect mean (average) waiting times.”*

Mullen PM. *Waiting lists and the NHS review*, HSMC, Birmingham, 1992.<sup>6</sup>

The author intended to assess whether there was evidence of queuing within Trauma & Orthopaedic waiting lists at 14 District General Hospitals in the former South West Thames Regional Health Authority. The research protocol proposing this novel application of survival techniques was approved by a medical statistician and withstood peer review. But it became obvious that official statistics used very different assumptions from those implied by lifetable analysis. A paper submitted to the *Journal of Health Services Research & Policy* was criticised by one reviewer on the grounds that it used unfamiliar methods! Given the potential repercussions on published research and the complacency of the intended audience, a fuller defence of the method appeared necessary. The lack of response from colleagues in the Department of Health forced the author to look for arguments and proofs that did not depend upon the quality of administrative data or on the validity of a series of assumptions (chapter 5). So although we discuss the consistency of existing methods with the idea of a health service queue (chapter 4) and show the unique relevance of the period lifetable to analysis of queuing priority (chapter 7), we do not begin to assess the extent of queuing within these Trauma & Orthopaedic waiting lists.

Mullen argues that average waiting times are not affected by the order of admission from the waiting list so that queuing, random selection and reverse queuing make no difference. But Mullen's assertion is based on a false premise, on a group of patients enrolled between two calendar dates and followed until every last one has been admitted to hospital. As a result, changing the order of admission 'pairs-off' dates of admission with different dates of enrolment so that the distribution of 'times-to-admission' changes on either side of the mean. The total time between enrolment and admission cannot change because the dates involved are unaltered and the mean 'time-to-admission' cannot change because the numbers admitted are also unaltered. Consider instead a group of patients listed together between two calendar dates of interest. They will all eventually be admitted but there were already some waiting at the beginning of the period of interest and there will still be some waiting at the close of the period of interest. As a result, the observed dates of admission 'could have been' allocated to individuals who were not admitted during the period of observation. The observed 'times-to-admission' and the observed 'times-to-census' are the product of one

particular series of decisions about who should be admitted next where a number of different sets of such decisions were possible.

The original question remains of interest though not so fundamentally important as unbiased estimation of patient waiting times. When the waiting list module of the Patient Administration System was introduced in the late 1980's and early 1990's, it offered the chance of making the waiting list explicit. Where patients cannot be added, admitted or removed without using the computer, there can be little excuse for 'overlooking' anyone which is more than could be said of the Kalamazoo or index card systems<sup>7</sup>. Now the computer is particularly good at sorting records and offered the chance of doing this rapidly where it once meant fumbling through stacks of dog-eared cards. But introducing the electronic waiting list meant persuading clinicians to surrender records held in desk drawers, it meant depriving medical secretaries of authority they enjoyed exercising and it meant changing the way in which admissions staff liked to work<sup>7</sup> so 'surrender' was sometimes conditional on carrying over established customs and practice. Anecdotal evidence suggests that some clinicians may pick patients they remember seeing as outpatients, unconsciously reversing the sequence of admissions from that recommended<sup>8,9</sup>. And the computer itself is quite capable of sorting records in the opposite fashion to that desired if there has been any mistake in setting it up. Hence, is there any evidence that 'time-since-enrolment' determines who is selected next where the only difference between patients is the length of time since their enrolment on the list?

#### Main contribution of thesis

*"We are seen as giving – independently of our employer – an assurance of validity, of completeness, of no bias, to the information that is released. Rarely can anyone else tell if that responsibility has been carried out well. The responsibility should be taken seriously."*

Simpson L. *Radical Statistics*, 71, 45-60, 1999.<sup>10</sup>

Some time ago, the Department of Health commissioned a review of the literature on waiting lists which was to provide an overview of the field and an indication of the lines of enquiry to be pursued in subsequent research. The unpublished draft<sup>11</sup> said very little about the measures used to describe patient waiting times, reflecting the literature's preoccupation with poor data and its blindness to the possibility of bad method; this thesis goes some way towards correcting that deficiency. In 1995, we believed there was a need for more waiting list research yet never dreamt it would be necessary to test the basic tools used in this area. So although there are few surprises here for the demographer, the epidemiologist or the medical statistician, we believe the findings of this thesis are of fundamental importance to research on waiting times and to that branch of the Government Statistical Service with responsibilities within the Department of Health.

This thesis highlights the implicit and improbable assumption that waiting lists are stationary and closed populations. It identifies four factors which might bias estimation of the cumulative likelihood of elective admission among all those at-risk  $({}_{x+n}q_0)$  when we use the method currently preferred by the Government Statistical Service in England  $({}_{x+n}q_0^{admissions})$  namely,

1. non-stationary rates of recruitment,
2. non-stationary rates of admission,
3. non-stationary category-specific conditional likelihoods and
4. likelihoods of 'having been admitted' that are not equal to 1.00.

It also illustrates the size of the errors possible if the data collected by the Department of Health were a plausible representation of the activities of Trauma & Orthopaedic units in South Thames Region between 1 July and 31 December 1994.

Where there are competing events, this thesis expects the Government Statistical Service method to overestimate the promptness of elective admission at every 'time-since-enrolment'. As a result, the burden of proof has shifted. Evidence that the waiting list is closed and stationary should accompany every future use of this method. Alternatively, there should be a clear explanation of why an inferior method was chosen and some assessment of the likely size and direction of bias. This thesis also expects ranked performance to depend on whether we use the Government Statistical Service measure or the cumulative likelihood of elective admission among all those at-risk.

Official statistics have led patients, clinicians, managers and politicians to believe that patient waiting times are rather better than is really the case. And *Health Service Indicators*<sup>12</sup> and *The NHS Performance Guide*<sup>13</sup> have led them to believe that good performance can be identified and rewarded although the rank correlation between the Government Statistical Service measure and the cumulative likelihood of elective admission among all those at-risk is far from perfect. With few exceptions<sup>14,15,16</sup>, independent researchers have used the Government Statistical Service method so the literature on waiting lists reports few waiting times which are immune to the bias described here<sup>16</sup>.

*"Where there are patients of equal clinical priority, preference should be given to those who have been waiting longest"*<sup>8</sup> and *"the principle 'first come, first served' for identical clinical conditions should be strictly adhered to"*<sup>9</sup>. But the number of people with longer or shorter 'times-since-enrolment' is what determines the position of the individual in the queue. And the Government Statistical Service method works by excluding large parts of the population at-risk. As a result, it is doubtful there has been any quantitative assessment of the extent of departure from strict queuing discipline i.e., the topic we originally set out to investigate remains as important as ever.

Now if we don't know how long people wait for elective admission, we can't expect to know who waits longest nor whether they are clinically best able to do so (chapter 5). We can't expect to address these questions satisfactorily unless we are prepared to invest in cohort studies, apply survival techniques or construct period lifetables for the population at-risk of elective admission. There is little such research in the literature on waiting lists.

The model described in this thesis changes our interpretation of the existing literature. It undermines our confidence in validation as a way of reducing the size of the waiting list. The validation exercise will not find anyone who needs to be removed, suspended or deferred where the records are already accurate and

up-to-the-minute<sup>17</sup>. And it suggests that an increase in admission rates may be partially offset by a decrease in competing events so the effect on the size of the waiting list may be less obvious than expected<sup>18</sup>.

Frankel<sup>19</sup> described the conditions which are common among long-waiters, noted that there was little there for the clinician to write home about and suggested that clinical disinterest might be responsible for long waiting times for these patients. But patients with long 'times-since-enrolment' could have exactly the same conditions as patients with short 'times-since-enrolment'. Frankel failed to establish whether the conditions which were common among long-waiters were equally common among patients newly recruited to the same urgency category.

We don't know whether putting patients to the back of the queue penalises those who 'self-deferred' or 'failed-to-attend' or rewards them with prompter admission! The Department of Health doesn't collect information on the 'times-since-enrolment' of KH06 admissions and certainly doesn't draw any distinction between those which followed a 'decision-to-admit' and those that had last been 'reset-to-zero'.

This thesis rehearses a very old argument in a new guise. Where we want to analyse length of time to the occurrence of an event, we must make proper allowance for right and left censored observations or else produce biased estimates. And if we choose to ignore censoring, we must explain how our method comes to be bias-free, contrary to all expectation. As a result, we expect the percentage of outpatients seen within 13 weeks and within 3 months of referral will prove to be vulnerable to bias in many of the ways outlined in this thesis although the presence, size and direction of bias needs to be separately established in each case. Regrettably, valid data provides no guarantee that statistics will be meaningful or useful<sup>1</sup>.

### Dissemination of results

*"One of the implications of this ... is that the problems that are not measured tend to get less attention or are not attended to at all. 'The assumption (is made) that what is not counted is not there'."*

Thomas R. *Radical Statistics*, 71, 66-73, 1999.<sup>20</sup>

The author has failed to convey the seriousness of these findings to the Department of Health despite a number of attempts to do so. An earlier version of the material that now forms chapters 2 & 5 had been copied to a number of colleagues within the Department of Health, the NHS and the Health Services Research community by March 1998. Several folk wrote back helpfully and at some length and none considered the work to be trivial or fallacious. And the material was well received at the British Society for Population Studies (1997), at the annual meeting of the Society for Social Medicine (1997), at 'Strategic Issues in Health Care Management' (1998) and at an international conference on Reliability and Survival Analysis (1998). The author also used this material to contribute to the formal consultation on High Level Performance Indicators<sup>21</sup> and to express concern about Cancer Waiting Times<sup>22</sup>. Despite several letters and a number of phone calls, the Department of Health has given no indication whether it accepts or rejects the case presented.

The material that forms chapters 3, 4, 6 & 7 was developed between August and November 1998 when the author was concentrating on writing the thesis for submission by 31 December 1998. The final report for this project was accepted by the Research & Development Directorate, South Thames Regional Office, in March 1999<sup>23</sup>. The author does not expect to pursue the matter further until the University of London has finally accepted this thesis.

## References

1. Sanderson HF. 'What's in a waiting list?', *BMJ*, 285, 1369 (1982).
2. Graunt J. 'Natural and Political observations made upon the Bills of Mortality', *Journal of the Institute of Actuaries*, 90(1), 1-? (1964). (Page 46.)
3. Greenwood M. 'Halley's life table', In: *Medical Statistics from Graunt to Farr*, Cambridge University Press, Cambridge, 1948. Pages 40-41.
4. Westergaard H. *Contributions to the history of statistics*, King, London, 1932. Page 22.
5. Halley E. 'An estimate of the degree of the mortality of mankind drawn from curious tables of the births and funerals of the city of Breslau', *Philosophical Transactions of the Royal Society of London*, 17, 596-610 (1693).
6. Mullen PM. *Waiting lists and the NHS review*, Health Services Management Centre, University of Birmingham, Birmingham, 1992. Page 2.
7. Pope C. 'Trouble in store: some thoughts on the management of waiting lists', *Sociology of Health & Illness*, 13(2), 193-212 (1991). Pages 198, 199, 206.
8. The Royal College of Surgeons of England. *Guidelines for the management of surgical waiting lists*, The Royal College of Surgeons of England, London, 1991. Section D, paragraph 3b.
9. Churchill K, Howard J, Jayes R. *Managing waiting lists for in-patients and day cases*, Qa Business Services Ltd., Department of Health, Birmingham, 1990. Pages II/7, III/17, III/19.
10. Simpson L. 'Statistical exclusion and social exclusion: the impact of missing data', *Radical Statistics*, 71, 45-60, (1999).
11. Faulkner A, Frankel S. *Delayed access to non-emergency NHS services. A review of NHS waiting times and waiting list research issues*, Health Care Evaluation Unit, Department of Social Medicine, University of Bristol, Bristol, 1993. .

12. NHS Executive. *Health Service Indicators. Background Information 1994/95*, Government Statistical Service, FPA-Performance Analysis, Leeds, 1996. WL44, WL92-WL94.
13. NHS Executive. *The NHS Performance Guide 1994-95*, Department of Health, Central Office of Information, Leeds, 1995.
14. Coid DR. 'Managing the Fife ENT waiting list: the 1989 review of problems', *Health Services Management Research*, 3(2), 82-86, (1990).
15. Williams DRR, West RJ, Hagard S, Dias AFS, 'Waiting list monitoring using information from hospital activity analysis and SBH 203 returns', *Community Medicine*, 5, 311-316, (1983).
16. Sharples L, Belcher C, Dennis C, Higenbotham T, Wallwork J. 'Who waits longest for heart and lung transplantation?', *Journal of Heart & Lung Transplantation*, 13(2), 282-91, (1994).
17. Lee A, Don B, Goldacre MJ. 'Waiting list statistics. II: an estimate of inflation of waiting list length', *BMJ*, 295, 1197-1198 (1987).
18. NHS Executive. *Additional resources in 1998-99 for 'whole systems' action to support sustained reductions in NHS waiting lists. HSC 1998/096*, NHS Executive, Department of Health, 1998.
19. Frankel S. 'The natural history of waiting lists – some wider explanations for an unnecessary problem', *Health Trends*, 21, 56-58, (1989).
20. Thomas R. 'Statistics and policy-making', *Radical Statistics*, 71, 66-73, (1999).
21. NHS Executive. *The new NHS Modern and Dependable: A National Framework for Assessing Performance. Consultation Document*. NHS Executive, Department of Health, 1998.
22. NHS Executive. *Cancer Waiting Times Audit. HSC 1998/014*, Department of Health, 1998.
23. Armstrong PW. *Some are Chosen, Some are Left! Who waits for elective orthopaedic surgery and why?*, Research & Development Directorate, South Thames Regional Office, London, 1999.

**Non nobis domine, domine**

**You trained my mind for understanding, my ear for truth.**

**Error jangled, bias glared.**

**You checked my progress and reined back my eager haste.**

**You tried the case and mended it's defence.**

**When all my confidence was gone, still you made me press on.**

**You exposed the lie before my eyes.**

**The bones are here for all to see.**





**[Source:** Department of Health, NHS Management Executive, Information Management Group. *The data manual: module 1.0: hospital services. Version 1.0,* Department of Health, Stanmore, 1992.]

PAGE NUMBERING AS IN THE  
ORIGINAL THESIS









[Source: Department of Health, NHS Management Executive, Information Management Group. *The data manual: module 1.0: hospital services. Version 1.0, Department of Health, Stanmore, 1992.*]

DE FORM PART **1**

ORDINARY ADMISSIONS

**KH06**

MAIN SPECIALTY FUNCTION	CODE	(4)	(5)	(6)	(7)	(8)
		NUMBER OF DECISIONS TO ADMIT	ADMISSIONS ARRANGED ADMITTED	PATIENT FAILED TO ATTEND	REMOVALS OTHER THAN ADMISSIONS	
GENERAL SURGERY	100					
UROLOGY	101					
TRAUMA AND ORTHOPAEDICS	110					
ENT	120					
OPHTHALMOLOGY	130					
ORAL SURGERY	140					
RESTORATIVE DENTISTRY	141					
PAEDIATRIC DENTISTRY	142					
ORTHODONTICS	143					
NEUROSURGERY	150					
PLASTIC SURGERY	160					
CARDIOTHORACIC SURGERY	170					
PAEDIATRIC SURGERY	171					
ACCIDENT & EMERGENCY	180					
ANAESTHETICS	190					
GENERAL MEDICINE	200					
GASTROENTEROLOGY	301					
ENDOCRINOLOGY	302					
HAEMATOLOGY (CLINICAL)	303					
CLINICAL PHYSIOLOGY	304					
CLINICAL PHARMACOLOGY	305					
AUDIOLOGICAL MEDICINE	310					
CLINICAL GENETICS	311					
CLINICAL CYTOGENETICS AND MOLECULAR GENETICS	312					
CLINICAL IMMUNOLOGY AND ALLERGY	313					
REHABILITATION	314					
PALLIATIVE MEDICINE	315					
CARDIOLOGY	320					
DERMATOLOGY	330					
THORACIC MEDICINE	340					
INFECTIOUS DISEASES	350					
GENITO URINARY MEDICINE	360					
PAGE TOTAL	KXXXX					

Sample



MAIN SPECIALTY FUNCTION	CODE	(4) NUMBER OF DECISIONS TO ADMIT	(6) ADMISSIONS ARRANGED		(8) REMOVALS OTHER TEAM ADMISSIONS
			(7) ADMITTED	(7) PATIENT FAILED TO ATTEND	
GENERAL SURGERY	100				
UROLOGY	101				
TRAUMA AND ORTHOPAEDICS	110				
ENT	120				
OPHTHALMOLOGY	130				
ORAL SURGERY	140				
RESTORATIVE DENTISTRY	141				
PAEDIATRIC DENTISTRY	142				
ORTHODONTICS	143				
NEUROSURGERY	150				
PLASTIC SURGERY	160				
CARDIOTHORACIC SURGERY	170				
PAEDIATRIC SURGERY	171				
ACCIDENT & EMERGENCY	180				
ANAESTHETICS	200				
GENERAL MEDICINE	300				
GASTROENTEROLOGY	301				
ENDOCRINOLOGY	302				
HAEMATOLOGY (CLINICAL)	303				
CLINICAL PHYSIOLOGY	304				
CLINICAL PHARMACOLOGY	305				
AUDIOLOGICAL MEDICINE	310				
CLINICAL GENETICS	311				
CLINICAL CYTOGENETICS AND MOLECULAR GENETICS	312				
CLINICAL IMMUNOLOGY AND ALLERGY	313				
REHABILITATION	314				
PALLIATIVE MEDICINE	315				
CARDIOLOGY	320				
DERMATOLOGY	330				
THORACIC MEDICINE	340				
INFECTIOUS DISEASES	350				
GENITO URINARY MEDICINE	360				
PAGE TOTAL	KXXX				

MAIN SPECIALTY FUNCTION	CODE	(4)	(5)	(6)	(7)	(8)	(9)	(10)	(11)	(12)	(13)	(14)	(15)	(16)	
		PATIENTS WAITING FOR ADMISSION			PATIENTS WAITING FOR ADMISSION BY MONTHS WAITING										
		WITH DATE	NO DATE	TOTAL	LESS THAN 3 MONTHS	3-5 MONTHS	6-8 MONTHS	9-11 MONTHS	12-14 MONTHS	15-17 MONTHS	18-20 MONTHS	21-23 MONTHS	24 MONTHS OR MORE		
GENERAL SURGERY	100														
UROLOGY	101														
TRAUMA AND ORTHOPAEDICS	110														
ENT	120														
OPHTHALMOLOGY	130														
ORAL SURGERY	140														
RESTORATIVE DENTISTRY	141														
PAEDIATRIC DENTISTRY	142														
ORTHODONTICS	143														
NEUROSURGERY	150														
PLASTIC SURGERY	160														
CARDIOTHORACIC SURGERY	170														
PAEDIATRIC SURGERY	171														
ACCIDENT & EMERGENCY	180														
ANAESTHETICS	190														
GENERAL MEDICINE	300														
GASTROENTEROLOGY	301														
ENDOCRINOLOGY	302														
HAEMATOLOGY (CLINICAL)	303														
CLINICAL PHYSIOLOGY	304														
CLINICAL PHARMACOLOGY	305														
PAGE TOTAL															

Sample

MAIN SPECIALTY FUNCTION	CODE	(4)	(5)	(6)	(7)	(8)	(9)	(10)	(11)	(12)	(13)	(14)	(15)	(16)	
		PATIENTS WAITING FOR ADMISSION			PATIENTS WAITING FOR ADMISSION BY MONTHS WAITING										
		WITH DATE	NO DATE	TOTAL	LESS THAN 3 MONTHS	3-5 MONTHS	6-8 MONTHS	9-11 MONTHS	12-14 MONTHS	15-17 MONTHS	18-20 MONTHS	21-23 MONTHS	24 MONTHS OR MORE		
GENERAL SURGERY	100														
UROLOGY	101														
TRAUMA AND ORTHOPAEDICS	110														
ENT	120														
OPHTHALMOLOGY	130														
ORAL SURGERY	140														
RESTORATIVE DENTISTRY	141														
PAEDIATRIC DENTISTRY	142														
ORTHODONTICS	143														
NEUROSURGERY	150														
PLASTIC SURGERY	160														
CARDIOTHORACIC SURGERY	170														
PAEDIATRIC SURGERY	171														
ACCIDENT & EMERGENCY	180														
ANAESTHETICS	190														
GENERAL MEDICINE	300														
GASTROENTEROLOGY	301														
ENDOCRINOLOGY	302														
HAEMATOLOGY (CLINICAL)	303														
CLINICAL PHYSIOLOGY	304														
CLINICAL PHARMACOLOGY	305														
PAGE TOTAL															

Sample

MAIN SPECIALTY FUNCTION	CODE	(4)		(5)		(6)	
		DEFERRED ADMISSIONS					
		ORDINARY ADMISSIONS		DAY CASE ADMISSIONS			
GENERAL SURGERY	100						
UROLOGY	101						
TRAUMA AND ORTHOPAEDICS	110						
ENT	120						
OPHTHALMOLOGY	130						
ORAL SURGERY	140						
RESTORATIVE DENTISTRY	141						
PAEDIATRIC DENTISTRY	142						
ORTHODONTICS	143						
NEUROSURGERY	150						
PLASTIC SURGERY	160						
CARDIOTHORACIC SURGERY	170						
PAEDIATRIC SURGERY	171						
ACCIDENT & EMERGENCY	180						
ANAESTHETICS	190						
GENERAL MEDICINE	300						
GASTROENTEROLOGY	301						
ENDOCRINOLOGY	302						
HAEMATOLOGY (CLINICAL)	303						
CLINICAL PHYSIOLOGY	304						
CLINICAL PHARMACOLOGY	305						
AUDIOLOGICAL MEDICINE	310						
CLINICAL GENETICS	311						
CLINICAL CYTOGENETICS & MOLECULAR GENETICS	312						
CLINICAL IMMUNOLOGY AND ALLERGY	313						
REHABILITATION	314						
PALLIATIVE MEDICINE	315						
CARDIOLOGY	320						
DERMATOLOGY	330						
THORACIC MEDICINE	340						
INFECTIOUS DISEASES	350						
GENITO-URINARY MEDICINE	360						
PAGE TOTAL	XXXX						

Sample

"PRINT\_QUESTION d1001/local"

TITLE "PID Download from PATIENT and WAITLSTENTRY."  
NEWLINE  
"-----"  
NEWLINE NEWLINE.

```
SELECT patient
THEN waitlstentry OF patient
WHERE count OF waitlstentry = 1
AND (codesubspeci OF waitlstentry ~ "11%"
OR codesubspeci OF waitlstentry ~ " "
OR codesubspeci OF waitlstentry ~ ")
THEN wlactivhist OF waitlstentry
WHERE orderwlhist OF wlactivhist = "000000001"
THEN wlacthistali OF wlactivhist
WHERE orderwlhist OF wlacthistali = "000000002"
OR orderwlhist OF wlacthistali < "000000001"

THEN mfmarralst OF patient
THEN mfreliigion OF patient
THEN mfeethnicorig OF patient

THEN mfwlurgency OF waitlstentry
THEN waitlist OF waitlstentry
THEN consultt OF waitlstentry
THEN subspeci OF waitlstentry
THEN mfhospital OF waitlstentry
THEN intendmanage OF waitlstentry
THEN mfwldiaggrp OF waitlstentry
THEN sourcerefer OF waitlstentry
THEN mfcategori OF waitlstentry
THEN specialcase OF waitlstentry
THEN mforward OF waitlstentry
THEN providers OF waitlstentry
THEN mftransport OF waitlstentry
THEN incare OF waitlstentry
THEN jntsubspeci OF waitlstentry
THEN jointconsult OF waitlstentry
THEN mfcontract OF waitlstentry
THEN waitliststat OF waitlstentry
THEN purchasers OF waitlstentry
THEN mfgdp OF waitlstentry
THEN mfgp OF waitlstentry
THEN mfintendmang OF waitlstentry
THEN mfjointspeci OF waitlstentry
THEN mfmethadamt OF waitlstentry
THEN mfspecialty OF waitlstentry
THEN mfwlremoval OF waitlstentry

THEN authority OF wlactivhist
THEN distres OF wlactivhist
THEN methodadmt OF wlactivhist
THEN mfwaitnglist OF wlactivhist.
```

DEFINE todate AS DATE1 = <TODAY>.

SORT waitlistkey OF waitlstentry.

```
FORMAT idpatient OF patient [9a]
FORMAT hospitalnum OF patient [10a] HEADED " " "PATPATN".
FORMAT sex OF patient [qaq] HEADED " " "HOSPNUM".
FORMAT validdob OF patient [3qa3q] HEADED " " "SEX".
FORMAT dob OF patient [6x4d7ydd": "6ydd": "7x] HEADED " " "VLIDDOB".
FORMAT deathind OF patient [3qa2q] HEADED " " "BIRTHDT".
FORMAT dateofdeath OF patient [6x4d7ydd": "6ydd": "7x] HEADED " " "DTHIND".
FORMAT codeoccupatn OF patient [2q4aq] HEADED " " "DEATHDT".
FORMAT occupatndesc OF patient [20a] HEADED " " "CDOCCUP".
FORMAT spouseoccdes OF patient [20a] HEADED " " "TXTOCCU".
FORMAT birthplace OF patient [20a] HEADED " " "SPOUSOC".
FORMAT pasmaristat OF patient [3qa3q] HEADED " " "BRTHPLC".
FORMAT descmaristat OF mfmarralst [20a] HEADED " " "MARITAL".
FORMAT pasreligion OF patient [2q4aq] HEADED " " "DSCMRTL".
FORMAT descreligion OF mfreliigion [20a] HEADED " " "RELIGIN".
FORMAT pasethncorg OF patient [2q4aq] HEADED " " "DSCRLGN".
FORMAT descethncorg OF mfeethnicorig [30a] HEADED " " "ETHNORG".
FORMAT birthePINum OF patient [9a] HEADED " " "DSCETHN".
FORMAT pasgp OF patient [6a] HEADED " " "MPARITY".
FORMAT pasgdp OF patient [6a] HEADED " " "PASGDP".
FORMAT idprovider OF patient [q5aq] HEADED " " "PASGDP".
FORMAT codeauthorth OF patient [2q3a2q] HEADED " " "PATPROV".
HEADED " " "PATAUTH".
```

FORMAT	bloodgroup	OF	patient	[2q3a2q]	HEADED	"	"	"BLODGRP".
FORMAT	allergies1	OF	patient	[15a]	HEADED	"	"	"ALLRGY1".
FORMAT	allergies2	OF	patient	[15a]	HEADED	"	"	"ALLRGY2".
FORMAT	waitlistkey	OF	waitlstentry	[27a]	HEADED	"	"	"WTLSTKY".
FORMAT	wlepisode	OF	waitlstentry	[q9a]	HEADED	"	"	"NTRYRK1".
FORMAT	pasurgency	OF	waitlstentry	[3qa3q]	HEADED	"	"	"URGENCY".
FORMAT	descurgency	OF	mfwlurgency	[15a]	HEADED	"	"	"DSCURGE".
FORMAT	paswaitlist	OF	waitlstentry	[q6a]	HEADED	"	"	"WAITLIST".
FORMAT	namewaitlist	OF	waitlist	[25a]	HEADED	"	"	"NMWLST".
FORMAT	codeconsultt	OF	waitlstentry	[q6a]	HEADED	"	"	"CONSULT".
FORMAT	nameconsultt	OF	consultt	[25a]	HEADED	"	"	"NMCNSLT".
FORMAT	codesubspeci	OF	waitlstentry	[2q3a2q]	HEADED	"	"	"SUBSPEC".
FORMAT	namesubspeci	OF	subspeci	[25a]	HEADED	"	"	"NMSBSPC".
FORMAT	pashospital	OF	waitlstentry	[2q4aq]	HEADED	"	"	"HOSPITL".
FORMAT	pasnamehospt	OF	mfhospital	[30a]	HEADED	"	"	"NMHSPTL".
FORMAT	shortnotice	OF	waitlstentry	[2q3a2q]	HEADED	"	"	"SHORTNT".
FORMAT	codemethadmt	OF	waitlstentry	[3q2a2q]	HEADED	"	"	"HOWLSTD".
FORMAT	codeintndman	OF	waitlstentry	[3qa3q]	HEADED	"	"	"NATADMN".
FORMAT	descintendmn	OF	intendmanage	[25a]	HEADED	"	"	"DSCNATA".
FORMAT	dateonlist	OF	waitlstentry	[6x4d7ydd": "6ydd": "7x]	HEADED	"	"	"ONLSTDT".
FORMAT	datestamp	OF	waitlstentry	[6x4d7ydd": "6ydd": "7x]	HEADED	"	"	"STAMPDT".
FORMAT	datewleftive	OF	waitlstentry	[6x4d7ydd": "6ydd": "7x]	HEADED	"	"	"EFTVEDT".
FORMAT	admissreason	OF	waitlstentry	[60a]	HEADED	"	"	"ADMSRSN".
FORMAT	operation	OF	waitlstentry	[60a]	HEADED	"	"	"OPERATN".
FORMAT	codewldiagr	OF	waitlstentry	[6aq]	HEADED	"	"	"DTAGGRP".
FORMAT	descwldiagr	OF	mfwldiagr	[30a]	HEADED	"	"	"DSCDIAG".
FORMAT	codesorceref	OF	waitlstentry	[3qa3q]	HEADED	"	"	"WHORFRD".
FORMAT	namesorceref	OF	sourcerefer	[25a]	HEADED	"	"	"NMWHORF".
FORMAT	pascategory	OF	waitlstentry	[2q3a2q]	HEADED	"	"	"ADMNCAT".
FORMAT	descpascateg	OF	mfcateg	[20a]	HEADED	"	"	"DSCADMN".
FORMAT	codeauthorty	OF	waitlstentry	[2q3a2q]	HEADED	"	"	"LSTAUTH".
FORMAT	codedistres	OF	waitlstentry	[2q3a2q]	HEADED	"	"	"DISTRES".
FORMAT	codeopproc	OF	waitlstentry	[2q4aq]	HEADED	"	"	"COPPRC".
FORMAT	pasprimproc	OF	waitlstentry	[q5aq]	HEADED	"	"	"PRMPROC".
FORMAT	codesubproc	OF	waitlstentry	[2q4aq]	HEADED	"	"	"CDSBPRC".
FORMAT	passubproc	OF	waitlstentry	[q5aq]	HEADED	"	"	"SUBPROC".
FORMAT	codespeccase	OF	waitlstentry	[2q3a2q]	HEADED	"	"	"SPECCESE".
FORMAT	namespeccase	OF	specialcase	[25a]	HEADED	"	"	"NMSPPCS".
FORMAT	pasward	OF	waitlstentry	[2q4aq]	HEADED	"	"	"HSPWARD".
FORMAT	pasnameward	OF	mforward	[30a]	HEADED	"	"	"NMHSPWD".
FORMAT	idprovider	OF	waitlstentry	[q5aq]	HEADED	"	"	"LSTPROV".
FORMAT	name	OF	providers	[50a]	HEADED	"	"	"NMPRVDR".
FORMAT	expectlensty	OF	waitlstentry	[7z-d]	HEADED	"	"	"XPLNSTY".
FORMAT	exptheatrme	OF	waitlstentry	[10a]	HEADED	"	"	"XPTHETR".
FORMAT	overseaexemp	OF	waitlstentry	[2q3a2q]	HEADED	"	"	"OVERSEA".
FORMAT	pastransport	OF	waitlstentry	[3q2a2q]	HEADED	"	"	"TRNSPRT".
FORMAT	descstransprt	OF	mfransport	[20a]	HEADED	"	"	"DSCTRNS".
FORMAT	accomperson	OF	waitlstentry	[2q3a2q]	HEADED	"	"	"ACCPND".
FORMAT	datelastrewv	OF	waitlstentry	[6x4d7ydd": "6ydd": "7x]	HEADED	"	"	"REVEWDT".
FORMAT	codefundhd5	OF	waitlstentry	[q5aq]	HEADED	"	"	"FUNDHLD".
FORMAT	codegdpdoh	OF	waitlstentry	[8a]	HEADED	"	"	"NATGDPS".
FORMAT	codegpdoh	OF	waitlstentry	[8a]	HEADED	"	"	"NATGPS".
FORMAT	codeincare	OF	waitlstentry	[2q3aq]	HEADED	"	"	"INCARE".
FORMAT	nameincare	OF	incare	[25a]	HEADED	"	"	"NMINCAR".
FORMAT	codepractice	OF	waitlstentry	[6a]	HEADED	"	"	"PRACT".
FORMAT	codjntsubspe	OF	waitlstentry	[2q3a2q]	HEADED	"	"	"JNTSPEC".
FORMAT	namesubspeci	OF	jntsubspeci	[25a]	HEADED	"	"	"NMJNTSP".
FORMAT	codjointcons	OF	waitlstentry	[q6a]	HEADED	"	"	"JNTCONS".
FORMAT	nameconsultt	OF	jointconsult	[25a]	HEADED	"	"	"NMJNTCO".
FORMAT	cont suffix	OF	waitlstentry	[q6a]	HEADED	"	"	"CONTSUF".
FORMAT	pasdescontr	OF	mcontract	[30a]	HEADED	"	"	"DSCCONT".
FORMAT	currcontrflg	OF	waitlstentry	[3qa3q]	HEADED	"	"	"CURCONT".
FORMAT	currdistrlg	OF	waitlstentry	[3qa3q]	HEADED	"	"	"CURDIST".
FORMAT	currentstat	OF	waitlstentry	[11a]	HEADED	"	"	"CURSTAT".
FORMAT	namewlstatus	OF	waitliststat	[40a]	HEADED	"	"	"NMCURST".
FORMAT	datewlcancel	OF	waitlstentry	[6x4d7ydd": "6ydd": "7x]	HEADED	"	"	"CANCLDT".
FORMAT	expdateadmis	OF	waitlstentry	[6x4d7ydd": "6ydd": "7x]	HEADED	"	"	"XPADMDT".
FORMAT	expectopdate	OF	waitlstentry	[6x4d7ydd": "6ydd": "7x]	HEADED	"	"	"XPOPDTTE".
FORMAT	dtol	OF	waitlstentry	[6x4d7ydd": "6ydd": "7x]	HEADED	"	"	"DTONL".
FORMAT	gpreferalnum	OF	waitlstentry	[8a]	HEADED	"	"	"GPRFNUM".
FORMAT	idadmission	OF	waitlstentry	[18a]	HEADED	"	"	"IDADMSN".
FORMAT	idpurchaser	OF	waitlstentry	[q5aq]	HEADED	"	"	"LSTPRCH".
FORMAT	name	OF	purchasers	[50a]	HEADED	"	"	"NMPURCH".
FORMAT	idpatient	OF	waitlstentry	[9a]	HEADED	"	"	"LSTPATN".
FORMAT	idwaitdiaggr	OF	waitlstentry	[12a]	HEADED	"	"	"WTDIAGR".
FORMAT	pasgdp	OF	waitlstentry	[q6a]	HEADED	"	"	"LSTGDPS".
FORMAT	pasnamegdp	OF	mfgdp	[35a]	HEADED	"	"	"NMGDPS".
FORMAT	pasgp	OF	waitlstentry	[6a]	HEADED	"	"	"LSTGPS".
FORMAT	pasnamegp	OF	mfgp	[34a]	HEADED	"	"	"NMGPS".
FORMAT	pasintendman	OF	waitlstentry	[3qa3q]	HEADED	"	"	"LOCADMN".

FORMAT descintendmn	OF	mfintendmang	[25a]						
FORMAT pasjointspec	OF	waitlstentry	[2q4aq]	HEADED	"	"	"	"DSCLOCA".	
FORMAT descspeci	OF	mfjointspeci	[30a]	HEADED	"	"	"	"PJNTSPC".	
FORMAT pasmethadmit	OF	waitlstentry	[3q2a2q]	HEADED	"	"	"	"DSCJNTS".	
FORMAT descmethadmt	OF	mfmethodadmt	[25a]	HEADED	"	"	"	"PHOWLST".	
FORMAT passpeci	OF	waitlstentry	[2q4aq]	HEADED	"	"	"	"DSCHOWL".	
FORMAT descspeci	OF	mfspecialty	[30a]	HEADED	"	"	"	"PSBSPEC".	
FORMAT postcode7	OF	waitlstentry	[7a]	HEADED	"	"	"	"DSCSBSP".	
FORMAT priproc_read	OF	waitlstentry	[7a]	HEADED	"	"	"	"PSTCDE7".	
FORMAT reviewresult	OF	waitlstentry	[22a]	HEADED	"	"	"	"READCDE".	
FORMAT timeonlist	OF	waitlstentry	[2qdd": "dd]	HEADED	"	"	"	"REVIEWD".	
FORMAT timestamp	OF	waitlstentry	[2qdd": "dd]	HEADED	"	"	"	"ONLSTTM".	
FORMAT timewlcancel	OF	waitlstentry	[2qdd": "dd]	HEADED	"	"	"	"STAMP TM".	
FORMAT codepurchasr	OF	waitlstentry	[2q3a2q]	HEADED	"	"	"	"CANCLTM".	
FORMAT idconsspec	OF	waitlstentry	[9a]	HEADED	"	"	"	"CDPURCH".	
FORMAT idcontract	OF	waitlstentry	[16a]	HEADED	"	"	"	"CNSSPEC".	
FORMAT idjntconspec	OF	waitlstentry	[9a]	HEADED	"	"	"	"CONTRCT".	
FORMAT idwaitinglst	OF	waitlstentry	[18a]	HEADED	"	"	"	"JNTCNBP".	
FORMAT monthonlist	OF	waitlstentry	[q6a]	HEADED	"	"	"	"LSTWTNG".	
FORMAT waitdistres	OF	waitlstentry	[9a]	HEADED	"	"	"	"MNTONHL".	
				HEADED	"	"	"	"WTDSTRS".	
FORMAT actstartdate	OF	wlactivhist	[6x4d7ydd": "6ydd": "7x]	HEADED	"	"	"	"STRTDT1".	
FORMAT actenddate	OF	wlactivhist	[6x4d7ydd": "6ydd": "7x]	HEADED	"	"	"	"ENDDT1 ".	
FORMAT orderwlhist	OF	wlactivhist	[9a]	HEADED	"	"	"	"ORDER01".	
FORMAT waitlistactv	OF	wlactivhist	[11a]	HEADED	"	"	"	"STATUS1".	
FORMAT paswlremove	OF	waitlstentry	[2q4aq]	HEADED	"	"	"	"CNCLRSN".	
FORMAT descwlremove	OF	mfwlremoval	[30a]	HEADED	"	"	"	"DSCCNCL".	
FORMAT defersusprsn	OF	wlactivhist	[30a]	HEADED	"	"	"	"DFSPRS1".	
FORMAT histreason	OF	wlactivhist	[2q4aq]	HEADED	"	"	"	"HSTRSN1".	
FORMAT codepreadcby	OF	wlactivhist	[3qa3q]	HEADED	"	"	"	"PRADCB1".	
FORMAT actendtime	OF	wlactivhist	[2qdd": "dd]	HEADED	"	"	"	"ENDTM1 ".	
FORMAT actstarttime	OF	wlactivhist	[2qdd": "dd]	HEADED	"	"	"	"STRTTM1".	
FORMAT codeauthority	OF	wlactivhist	[2q3a2q]	HEADED	"	"	"	"HSTATH1".	
FORMAT descauthority	OF	authority	[40a]	HEADED	"	"	"	"DCATH1".	
FORMAT codedistres	OF	wlactivhist	[2q3a2q]	HEADED	"	"	"	"HSTDST1".	
FORMAT namedistrict	OF	distres	[25a]	HEADED	"	"	"	"NMDISTR".	
FORMAT codemethadmt	OF	wlactivhist	[3q2a2q]	HEADED	"	"	"	"HSTHOW1".	
FORMAT descmethadmt	OF	methodadmit	[25a]	HEADED	"	"	"	"DSCHOW1".	
FORMAT deferuntildt	OF	wlactivhist	[6x4d7ydd": "6ydd": "7x]	HEADED	"	"	"	"DFRNDT1".	
FORMAT enddistres	OF	wlactivhist	[9a]	HEADED	"	"	"	"ENDDST1".	
FORMAT hideflag	OF	wlactivhist	[3qa3q]	HEADED	"	"	"	"HIDFLG1".	
FORMAT idpatient	OF	wlactivhist	[9a]	HEADED	"	"	"	"HSTPAT1".	
FORMAT idwaitlhist	OF	wlactivhist	[27a]	HEADED	"	"	"	"WTLHST1".	
FORMAT idwaitinglst	OF	wlactivhist	[18a]	HEADED	"	"	"	"HSTWTN1".	
FORMAT monthofend	OF	wlactivhist	[q6a]	HEADED	"	"	"	"MNTND1".	
FORMAT padmcanctate	OF	wlactivhist	[6x4d7ydd": "6ydd": "7x]	HEADED	"	"	"	"PADMCD1".	
FORMAT padmcanctime	OF	wlactivhist	[2qdd": "dd]	HEADED	"	"	"	"PADMCT1".	
FORMAT padmeadmdate	OF	wlactivhist	[6x4d7ydd": "6ydd": "7x]	HEADED	"	"	"	"PADMED1".	
FORMAT padmeadmtime	OF	wlactivhist	[2qdd": "dd]	HEADED	"	"	"	"PADMET1".	
FORMAT paswaitlist	OF	wlactivhist	[q6a]	HEADED	"	"	"	"HSTWT1 ".	
FORMAT descwaitlist	OF	mfwaitnglist	[30a]	HEADED	"	"	"	"DSCLST1".	
FORMAT ppadmeadmte	OF	wlactivhist	[6x4d7ydd": "6ydd": "7x]	HEADED	"	"	"	"PPADED1".	
FORMAT ppadmeadmtime	OF	wlactivhist	[2qdd": "dd]	HEADED	"	"	"	"PPAET1".	
FORMAT waitingsince	OF	wlactivhist	[6x4d7ydd": "6ydd": "7x]	HEADED	"	"	"	"SINCED1".	
FORMAT waitlhistkey	OF	wlactivhist	[36a]	HEADED	"	"	"	"HSTKEY1".	
FORMAT wlepisode	OF	wlactivhist	[9a]	HEADED	"	"	"	"NTRYRK2".	
FORMAT actstartdate	OF	wlacthistali	[6x4d7ydd": "6ydd": "7x]	HEADED	"	"	"	"STRTDT2".	
FORMAT actenddate	OF	wlacthistali	[6x4d7ydd": "6ydd": "7x]	HEADED	"	"	"	"ENDDT2 ".	
FORMAT orderwlhist	OF	wlacthistali	[9a]	HEADED	"	"	"	"ORDER02".	
FORMAT waitlistactv	OF	wlacthistali	[11a]	HEADED	"	"	"	"STATUS2".	
FORMAT defersusprsn	OF	wlacthistali	[30a]	HEADED	"	"	"	"DFSPRS2".	
FORMAT histreason	OF	wlacthistali	[2q4aq]	HEADED	"	"	"	"HSTRSN2".	
FORMAT codepreadcby	OF	wlacthistali	[3qa3q]	HEADED	"	"	"	"PRADCB2".	
FORMAT actendtime	OF	wlacthistali	[2qdd": "dd]	HEADED	"	"	"	"ENDTM2 ".	
FORMAT actstarttime	OF	wlacthistali	[2qdd": "dd]	HEADED	"	"	"	"STRTTM2".	
FORMAT codeauthority	OF	wlacthistali	[2q3a2q]	HEADED	"	"	"	"HSTATH2".	
FORMAT codedistres	OF	wlacthistali	[2q3a2q]	HEADED	"	"	"	"HSTDST2".	
FORMAT codemethadmt	OF	wlacthistali	[3q2a2q]	HEADED	"	"	"	"HSTHOW2".	
FORMAT deferuntildt	OF	wlacthistali	[6x4d7ydd": "6ydd": "7x]	HEADED	"	"	"	"DFRNDT2".	
FORMAT enddistres	OF	wlacthistali	[9a]	HEADED	"	"	"	"ENDDST2".	
FORMAT hideflag	OF	wlacthistali	[3qa3q]	HEADED	"	"	"	"HIDFLG2".	
FORMAT idpatient	OF	wlacthistali	[9a]	HEADED	"	"	"	"HSTPAT2".	
FORMAT idwaitlhist	OF	wlacthistali	[27a]	HEADED	"	"	"	"WTLHST2".	
FORMAT idwaitinglst	OF	wlacthistali	[18a]	HEADED	"	"	"	"HSTWTN2".	
FORMAT monthofend	OF	wlacthistali	[q6a]	HEADED	"	"	"	"MNTND2".	
FORMAT padmcanctate	OF	wlacthistali	[6x4d7ydd": "6ydd": "7x]	HEADED	"	"	"	"PADMCD2".	
FORMAT padmcanctime	OF	wlacthistali	[2qdd": "dd]	HEADED	"	"	"	"PADMCT2".	
FORMAT padmeadmdate	OF	wlacthistali	[6x4d7ydd": "6ydd": "7x]	HEADED	"	"	"	"PADMED2".	
FORMAT padmeadmtime	OF	wlacthistali	[2qdd": "dd]	HEADED	"	"	"	"PADMET2".	
FORMAT paswaitlist	OF	wlacthistali	[q6a]	HEADED	"	"	"	"HSTWT2 ".	

```

FORMAT ppadmeadmte OF wlaclhistali [6x4d7ydd":"6ydd":"7x] HEADED "" "" "PPADED2".
FORMAT ppadmeadmtme OF wlaclhistali [2qdd":"dd] HEADED "" "" "PPADET2".
FORMAT waitingsince OF wlaclhistali [6x4d7ydd":"6ydd":"7x] HEADED "" "" "SINCED2".
FORMAT waitlhistkey OF wlaclhistali [36a] HEADED "" "" "HSTKEY2".
FORMAT wlepisode OF wlaclhistali [9a] HEADED "" "" "NTRYRK3".

```

```

FORMAT todate OF DEFINE [6x4d7ydd":"6ydd":"7x].

```

```

FIELDGAP 0.
PAGESIZE 1000000.
NOHEAD.

```

```

HEAD "PATPATN ""|" "HOSPNUM ""|" "SEX""|" "VLIDDOB""|" "BIRTHDT ""|"
"DTHIND""|" "DEATHDT ""|" "CDOCCUP""|" "TXTOCCU ""|"
"SPOUSOC ""|" "BRTHPLC ""|" "MARITAL""|"
"DSCMRTL ""|" "RELIGIN""|" "DSCRLGN ""|"
"ETHNORG""|" "DSCETHN ""|" "MPARITY ""|"
"PASGPS""|" "PASGDP""|"
"PATPROV""|" "PATAUTH""|" "BLODGRP""|" "ALLRGY1 ""|"
"ALLRGY2 ""|"

"WTLSTKY ""|" "NTRYRK1 ""|" "URGENCY""|"
"DSCURGE ""|" "WAITLST""|" "NMWLST ""|"
"CONSULT""|" "NMCNSLT ""|" "SUBSPEC""|"
"NMSBSPC ""|" "HOSPITL""|"
"NMHSPTL ""|" "SHORTNT""|"
"HOWLSTD""|" "NATADMN""|" "DSCNATA ""|"
"ONLSTDT ""|" "STAMPDT ""|" "EFTVEDT ""|"
"ADMSRSN ""|"
"OPERATN ""|"
"DIAGGRP""|" "DSCDIAG ""|" "WHORFRD""|"
"NMWHORF ""|" "ADMNCAT""|" "DSCADMN ""|"
"LSTAUTH""|" "DISTRES""|" "CDOPPRC""|" "PRMPROC""|" "CDSBPRC""|"
"SUBPROC""|" "SPECCESE""|" "NMSPCCS ""|" "HSPWARD""|"
"NMHSPWD ""|"
"LSTPROV""|" "NMPRVDR ""|"
"XPLNSTY ""|" "XPTHETR ""|" "OVERSEA""|"
"TRNSPRT""|" "DSCTRNS ""|"
"ACMPND""|" "REVEWDT ""|" "FUNDHLD""|" "NATGDPS ""|"
"NATGPS ""|" "INCARE ""|" "NMINCAR ""|"
"PRACT ""|" "JNTSPEC""|" "NMJNTSP ""|" "JNTCONS""|"
"NMJNTCO ""|" "CONTSUF""|"
"DSCCONT ""|" "CURCONT""|" "CURDIST""|"
"CURSTAT ""|" "NMCURST ""|"
"CANCLDT ""|"
"XPADMDT ""|" "XPOPDTE ""|" "DTONL ""|" "GPRFNUM ""|"
"IDADMSN ""|" "LSTPRCH""|"
"NMPURCH ""|" "LSTPATN ""|"
"WTDIAGR ""|" "LSTGDPS""|" "NMGDPS ""|"
"LSTGSPS""|" "NMGPS ""|"
"LOCADMN""|" "DSCLOCA ""|"
"PJNTSPC""|" "DSCJNTS ""|" "PHOWLST""|"
"DSCHOWL ""|" "PSBSPEC""|"
"DSCSBSP ""|"
"PSTCDE7""|" "READCDE""|" "REVIEWD ""|" "ONLSTTM""|"
"STAMPMT""|" "CANCLTM""|" "CDPURCH""|" "CNSSPEC ""|"
"CONTRCT ""|" "JNTCNSP ""|" "LSTWTNG ""|"
"MNTHONL""|" "WTDSTRS ""|"

"STRTDT1 ""|" "ENDDT1 ""|" "ORDER01 ""|" "STATUS1 ""|"
"CNCLRSN""|" "DSCCNCL ""|"
"DFSPRS1 ""|" "HSTRSN1""|"
"PRADCB1""|" "ENDTM1 ""|" "STRTTM1""|" "HSTATH1""|"
"DSCATH1 ""|" "HSTDST1""|"
"NMDISTR ""|" "HSTHOW1""|" "DSCHOW1 ""|"
"DFRNDT1 ""|" "ENDDST1 ""|" "HIDFLG1""|" "HSTPAT1 ""|"
"WTLHST1 ""|" "HSTWTN1 ""|" "MNTHND1""|"
"PADMCD1 ""|" "PADMCT1""|" "PADMED1 ""|" "PADMET1""|" "HSTWT1 ""|"
"DSCLST1 ""|"
"PPADED1 ""|" "PPADET1""|" "SINCED1 ""|"
"HSTKEY1 ""|" "NTRYRK2 ""|"

"STRTDT2 ""|" "ENDDT2 ""|" "ORDER02 ""|" "STATUS2 ""|"
"DFSPRS2 ""|" "HSTRSN2""|"
"PRADCB2""|" "ENDTM2 ""|" "STRTTM2""|" "HSTATH2""|" "HSTDST2""|"
"HSTHOW2""|" "DFRNDT2 ""|" "ENDDST2 ""|" "HIDFLG2""|" "HSTPAT2 ""|"
"WTLHST2 ""|" "HSTWTN2 ""|" "MNTHND2""|"
"PADMCD2 ""|" "PADMCT2""|" "PADMED2 ""|" "PADMET2""|" "HSTWT2 ""|"
"PPADED2 ""|" "PPADET2""|" "SINCED2 ""|"
"HSTKEY2 ""|" "NTRYRK3 ""|"
NEWLINE.

```



PRINT

"	"	idpatient	OF patient	"	"	hospitalnum	OF patient
"	"	sex	OF patient	"	"	validdob	OF patient
"	"	dob	OF patient	"	"	deathind	OF patient
"	"	dateofdeath	OF patient	"	"	codeoccupatn	OF patient
"	"	occupatndesc	OF patient	"	"	spouseoccdes	OF patient
"	"	birthplace	OF patient	"	"	pasmaristat	OF patient
"	"	descmaristat	OF mfmarristat	"	"	pasreligion	OF patient
"	"	descreligion	OF mfreigion	"	"	pasethncorg	OF patient
"	"	descethncorg	OF mfethncorig	"	"	birthePINum	OF patient
"	"	pasgp	OF patient	"	"	pasgdp	OF patient
"	"	idprovider	OF patient	"	"	codeauthoty	OF patient
"	"	bloodgroup	OF patient	"	"	allergiesl	OF patient
"	"	allergies2	OF patient	"	"		
"	"	waitlistkey	OF waitlstentry	"	"	wlepisode	OF waitlstentry
"	"	pasurgency	OF waitlstentry	"	"	descurgency	OF mfwlurgency
"	"	paswaitlist	OF waitlstentry	"	"	namewaitlist	OF waitlist
"	"	codeconsultt	OF waitlstentry	"	"	nameconsultt	OF consultt
"	"	codesubspeci	OF waitlstentry	"	"	namesubspeci	OF subspeci
"	"	pashospital	OF waitlstentry	"	"	pasnamehospt	OF mfhospital
"	"	shortnotice	OF waitlstentry	"	"	codemethadmt	OF waitlstentry
"	"	codeintndman	OF waitlstentry	"	"	descintendmn	OF intendmanage
"	"	dateonlist	OF waitlstentry	"	"	datestamp	OF waitlstentry
"	"	dateleftive	OF waitlstentry	"	"	admissreason	OF waitlstentry
"	"	operation	OF waitlstentry	"	"	codewldiagrp	OF waitlstentry
"	"	descwldiagrp	OF mfwldiagrp	"	"	codesorceref	OF waitlstentry
"	"	namesorceref	OF sourcerefer	"	"	pascategory	OF waitlstentry
"	"	descpascateg	OF mfcategory	"	"	codeauthoty	OF waitlstentry
"	"	codedistres	OF waitlstentry	"	"	codeopproc	OF waitlstentry
"	"	pasprimproc	OF waitlstentry	"	"	codesubproc	OF waitlstentry
"	"	passubproc	OF waitlstentry	"	"	codespeccase	OF waitlstentry
"	"	namespeccase	OF specialcase	"	"	pasward	OF waitlstentry
"	"	pasnameward	OF mforward	"	"	idprovider	OF waitlstentry
"	"	name	OF providers	"	"	expectlensty	OF waitlstentry
"	"	exptheatrtme	OF waitlstentry	"	"	overseaexemp	OF waitlstentry
"	"	pastransport	OF waitlstentry	"	"	desctransprt	OF mftransport
"	"	accomperson	OF waitlstentry	"	"	datelastrevw	OF waitlstentry
"	"	codefundhd5	OF waitlstentry	"	"	codegdpdoh	OF waitlstentry
"	"	codegpdoh	OF waitlstentry	"	"	codeincare	OF waitlstentry
"	"	nameincare	OF incare	"	"	codepractice	OF waitlstentry
"	"	codjntsubspe	OF waitlstentry	"	"	namesubspeci	OF jntsubspeci
"	"	codjointcons	OF waitlstentry	"	"	nameconsultt	OF jointconsult
"	"	cont_suffix	OF waitlstentry	"	"	pasdescontr	OF mfcontract
"	"	currContrflg	OF waitlstentry	"	"	currdistrlflg	OF waitlstentry
"	"	currentstat	OF waitlstentry	"	"	namewlstatus	OF waitliststat
"	"	datewlcancel	OF waitlstentry	"	"	expdateadmis	OF waitlstentry
"	"	expectopdate	OF waitlstentry	"	"	dtonl	OF waitlstentry
"	"	gpreferalnum	OF waitlstentry	"	"	idadmission	OF waitlstentry
"	"	idpurchaser	OF waitlstentry	"	"	name	OF purchasers
"	"	idpatient	OF waitlstentry	"	"	idwaitdiaggr	OF waitlstentry
"	"	pasgdp	OF waitlstentry	"	"	pasnamegdp	OF mfgdp
"	"	pasgp	OF waitlstentry	"	"	pasnamegp	OF mfgp
"	"	pasintendman	OF waitlstentry	"	"	descintendmn	OF mfintendmang
"	"	pasjointspec	OF waitlstentry	"	"	descspeci	OF mfjointspeci
"	"	pasmethadmit	OF waitlstentry	"	"	descmethadmt	OF mfmethadadmt
"	"	passpeci	OF waitlstentry	"	"	descspeci	OF mfspecialty
"	"	postcode7	OF waitlstentry	"	"		
"	"	priproc_read	OF waitlstentry	"	"	reviewresult	OF waitlstentry
"	"	timeonlist	OF waitlstentry	"	"	timestamp	OF waitlstentry
"	"	timewlcancel	OF waitlstentry	"	"	codepurchasr	OF waitlstentry
"	"	idconspec	OF waitlstentry	"	"	idcontract	OF waitlstentry
"	"	idjntconspec	OF waitlstentry	"	"	idwaitinglst	OF waitlstentry
"	"	monthonlist	OF waitlstentry	"	"	waitdistres	OF waitlstentry
"	"	actstartdate	OF wlactivhist	"	"	actenddate	OF wlactivhist
"	"	orderwlhist	OF wlactivhist	"	"	waitlistactv	OF wlactivhist
"	"	paswlremove	OF waitlstentry	"	"	descwlremove	OF mfwlremoval
"	"	defersusprsn	OF wlactivhist	"	"	histreason	OF wlactivhist
"	"	codepreadcby	OF wlactivhist	"	"	actendtime	OF wlactivhist
"	"	actstarttime	OF wlactivhist	"	"	codeauthoty	OF wlactivhist
"	"	descauthoty	OF authority	"	"	codedistres	OF wlactivhist
"	"	namedistrict	OF distres	"	"	codemethadmt	OF wlactivhist
"	"	descmethadmt	OF methodadmit	"	"	deferuntildt	OF wlactivhist
"	"	enddistres	OF wlactivhist	"	"	hideflag	OF wlactivhist
"	"	idpatient	OF wlactivhist	"	"	idwaitlhist	OF wlactivhist
"	"	idwaitinglst	OF wlactivhist	"	"	monthofend	OF wlactivhist
"	"	padmcancdate	OF wlactivhist	"	"	padmcancntime	OF wlactivhist
"	"	padmeadmdate	OF wlactivhist	"	"	padmeadmtime	OF wlactivhist
"	"	paswaitlist	OF wlactivhist	"	"	descwaitlist	OF mfwaitnglist
"	"	ppadmeadmte	OF wlactivhist	"	"	ppadmeadmtime	OF wlactivhist
"	"	waitingsince	OF wlactivhist	"	"	waitlhistkey	OF wlactivhist
"	"	wlepisode	OF wlactivhist	"	"		

```

|" actstartdate OF wlaclhistali "|" actenddate OF wlaclhistali
|" orderwlhist OF wlaclhistali "|" waitlistactv OF wlaclhistali
|" defersusprsn OF wlaclhistali "|" histreason OF wlaclhistali
|" codepreadcby OF wlaclhistali "|" actendtime OF wlaclhistali
|" actstarttime OF wlaclhistali "|" codeauthorty OF wlaclhistali
|" codedistres OF wlaclhistali "|" codemethadmt OF wlaclhistali
|" deferuntildt OF wlaclhistali "|" enddistres OF wlaclhistali
|" hideflag OF wlaclhistali "|" idpatient OF wlaclhistali
|" idwaitlhist OF wlaclhistali "|" idwaitinglst OF wlaclhistali
|" monthofend OF wlaclhistali "|" padmcanccdate OF wlaclhistali
|" padmcanctime OF wlaclhistali "|" padmeadmdate OF wlaclhistali
|" padmeadmtime OF wlaclhistali "|" paswaitlist OF wlaclhistali
|" ppadmeadmte OF wlaclhistali "|" ppadmeadmtime OF wlaclhistali
|" waitingsince OF wlaclhistali "|" waitlhistkey OF wlaclhistali
|" wlepisode OF wlaclhistali "|".

```

```

TOTAL0 NEWLINE NEWLINE NEWLINE NEWLINE
"PWA/dl001/" todate.

```

TITLE "PID Download from WLACTIVHIST."  
 NEWLINE  
 "~~~~~"  
 NEWLINE NEWLINE.

```
SELECT waitlstentry
WHERE (codesubspeci OF waitlstentry ~ "11%"
OR codesubspeci OF waitlstentry ~ " "
OR codesubspeci OF waitlstentry ~ "")
THEN wlactivhist OF waitlstentry
WHERE orderwlhist OF wlactivhist > "000000001"

THEN authority OF wlactivhist
THEN distres OF wlactivhist
THEN methodadmit OF wlactivhist
THEN mfwaitnglist OF wlactivhist.
```

DEFINE todate AS DATE1 = <TODAY>.

```
FORMAT actstartdate OF wlactivhist [6x4d7ydd": "6ydd": "7x] HEADED "" "" "STRTDT ".
FORMAT actenddate OF wlactivhist [6x4d7ydd": "6ydd": "7x] HEADED "" "" "ENDDT ".
FORMAT orderwlhist OF wlactivhist [9a] HEADED "" "" "ORDER ".
FORMAT waitlistactv OF wlactivhist [11a] HEADED "" "" "STATUS ".
FORMAT defersusprsn OF wlactivhist [30a] HEADED "" "" "DFSPRS ".
FORMAT histreason OF wlactivhist [2q4aq] HEADED "" "" "HSTRSN ".
FORMAT codepreadcby OF wlactivhist [3qa3q] HEADED "" "" "PRADCB ".
FORMAT actendtime OF wlactivhist [2qdd": "dd] HEADED "" "" "ENDTM ".
FORMAT actstarttime OF wlactivhist [2qdd": "dd] HEADED "" "" "STRTTM ".
FORMAT codeauthority OF wlactivhist [2q3a2q] HEADED "" "" "HSTATH ".
FORMAT descauthority OF authority [40a] HEADED "" "" "DSCATH ".
FORMAT codedistres OF wlactivhist [2q3a2q] HEADED "" "" "HSTDST ".
FORMAT namedistrict OF distres [25a] HEADED "" "" "NMDIST ".
FORMAT codemethadmt OF wlactivhist [3q2a2q] HEADED "" "" "HSTHOW ".
FORMAT descmethadmt OF methodadmit [25a] HEADED "" "" "DSCHOW ".
FORMAT deferuntildt OF wlactivhist [6x4d7ydd": "6ydd": "7x] HEADED "" "" "DFRNDT ".
FORMAT enddistres OF wlactivhist [9a] HEADED "" "" "ENDDST ".
FORMAT hideflag OF wlactivhist [3qa3q] HEADED "" "" "HIDFLG ".
FORMAT idpatient OF wlactivhist [9a] HEADED "" "" "HSTPAT ".
FORMAT idwaitlhist OF wlactivhist [27a] HEADED "" "" "WTLHST ".
FORMAT idwaitinglst OF wlactivhist [18a] HEADED "" "" "HSTWTN ".
FORMAT monthofend OF wlactivhist [q6a] HEADED "" "" "MNTHND ".
FORMAT padmcanctate OF wlactivhist [6x4d7ydd": "6ydd": "7x] HEADED "" "" "PADMCD ".
FORMAT padmcanctime OF wlactivhist [2qdd": "dd] HEADED "" "" "PADMCT ".
FORMAT padmeadmdate OF wlactivhist [6x4d7ydd": "6ydd": "7x] HEADED "" "" "PADMED ".
FORMAT padmeadmtime OF wlactivhist [2qdd": "dd] HEADED "" "" "PADMET ".
FORMAT paswaitlist OF wlactivhist [q6a] HEADED "" "" "HSTWT ".
FORMAT descwaitlist OF mfwaitnglist [30a] HEADED "" "" "DSCLST ".
FORMAT ppadmeadmte OF wlactivhist [6x4d7ydd": "6ydd": "7x] HEADED "" "" "PPADED ".
FORMAT ppadmeadmtime OF wlactivhist [2qdd": "dd] HEADED "" "" "PPADET ".
FORMAT waitingsince OF wlactivhist [6x4d7ydd": "6ydd": "7x] HEADED "" "" "SINCED ".
FORMAT waitlhistkey OF wlactivhist [36a] HEADED "" "" "HSTKEY ".
FORMAT wlepisode OF wlactivhist [9a] HEADED "" "" "NTRYRK ".
FORMAT todate OF DEFINE [6x4d7ydd": "6ydd": "7x].
```

FIELDGAP 0.  
 PAGESIZE 1000000.  
 NOHEAD.

```
HEAD "STRTDT ""|" "ENDDT ""|" "ORDER ""|" "STATUS ""|"
      "DFSPRS ""|" "HSTRSN ""|"
      "PRADCB ""|" "ENDTM ""|" "STRTTM ""|" "HSTATH ""|"
      "DSCATH ""|" "HSTDST ""|"
      "NMDIST ""|" "HSTHOW ""|" "DSCHOW ""|"
      "DFRNDT ""|" "ENDDST ""|" "HIDFLG ""|" "HSTPAT ""|"
      "WTLHST ""|" "HSTWTN ""|" "MNTHND ""|"
      "PADMCD ""|" "PADMCT ""|" "PADMED ""|" "PADMET ""|" "HSTWT ""|"
      "DSCLST ""|"
      "PPADED ""|" "PPADET ""|" "SINCED ""|"
      "HSTKEY ""|" "NTRYRK ""
```

```
PRINT actstartdate OF wlactivhist "|" actenddate OF wlactivhist
      orderwlhist OF wlactivhist "|" waitlistactv OF wlactivhist
      defersusprsn OF wlactivhist "|" histreason OF wlactivhist
      codepreadcby OF wlactivhist "|" actendtime OF wlactivhist
      actstarttime OF wlactivhist "|" codeauthority OF wlactivhist
      descauthority OF authority "|" codedistres OF wlactivhist
      namedistrict OF distres "|" codemethadmt OF wlactivhist
      descmethadmt OF methodadmit "|" deferuntildt OF wlactivhist
      enddistres OF wlactivhist "|" hideflag OF wlactivhist
      idpatient OF wlactivhist "|" idwaitlhist OF wlactivhist
```

"|" idwaitinglst OF wlactivhist "|" monthofend OF wlactivhist  
"|" padmcanccdate OF wlactivhist "|" padmcanctime OF wlactivhist  
"|" padmeadmdate OF wlactivhist "|" padmeadmtime OF wlactivhist  
"|" paswaitlist OF wlactivhist "|" descwaitlist OF mfwaitnglist  
"|" ppadmeadmte OF wlactivhist "|" ppadmeadmtime OF wlactivhist  
"|" waitingsince OF wlactivhist "|" waitlhistkey OF wlactivhist  
"|" wlepisode OF wlactivhist "|".

TOTAL0 NEWLINE NEWLINE NEWLINE NEWLINE  
"PWA/D1002/" todate.



Table 3.1a: Count of the total number of valid elective episodes generated by Trauma & Orthopaedic waiting lists in South Thames Region BY quarter enrolled BY hospital

Source:	<i>Hospital Episode Statistics 1994/95</i>				1994/95 & 1993/94		
Hospital	1995 Q1	1994 Q4	1994 Q3	1994 Q2	1994 Q1	1993 Q4	1993 Q3
RA1	159	336	447	552	389+146=535	171+202=373	127+362=489
RA2	90	176	227	288	215+117=332	166+260=426	140+287=427
RAV	-	-	-	-	-	-	-
RAX	91	195	291	342	258+ 61=319	137+160=297	75+220=295
RAZ	135	292	305	374	328+105=433	161+255=416	148+345=493
RCY	36	122	136	206	184+ 46=230	158+ 71=229	59+ 79=138
RDL	98	306	374	397	303+154=457	213+280=493	162+352=514
RDM	142	272	340	376	287+101=388	165+246=411	140+302=442
RDR	2	1	8	6	16+ 6= 22	9+ 3= 12	7+ 11= 18
RDU	154	231	263	358	279+130=409	184+236=420	120+183=303
RDV	117	281	276	313	300+ 59=359	215+196=411	143+226=369
RG1	90	213	264	250	148+ 56=204	87+124=211	58+219=277
RG2	59	168	234	263	244+ 67=311	132+134=266	116+253=369
RG3	132	319	379	311	275+107=382	216+189=405	217+251=468
RGU	111	233	248	250	149+ 82=231	86+123=209	81+154=235
RGV	94	178	229	240	236+ 46=282	91+149=240	59+183=242
RGW	44	138	130	153	135+ 50=185	43+ 90=133	72+140=212
RGX	45	62	65	95	64+ 36=100	32+ 58= 90	3+ 79= 82
RGZ	105	221	282	303	172+109=281	76+255=331	63+278=341
RHE	26	63	80	134	132+ 24=156	128+ 42=170	130+ 59=189
RHG	79	146	180	208	126+ 76=202	42+142=184	16+179=195
RHH	97	188	216	258	280+ 69=349	153+170=323	103+240=343
RJ1	104	192	304	313	318+151=469	186+248=434	128+400=528
RJ2	103	225	243	304	180+ 95=275	156+195=351	109+198=307
RJ6	173	297	419	402	349+100=449	178+214=392	162+334=496
RJ7	116	262	246	295	203+ 89=292	70+159=229	21+ 88=109
RJZ	51	122	191	204	210+ 60=270	137+106=243	83+130=213
RN7	46	206	276	342	308	208	130
RPA	165	284	382	434	315	134	124
RPC	10	17	33	22	13	5	7
RPD	76	183	250	262	264	170	112
RPF	173	446	543	569	449	267	190
RPL	132	299	357	413	338	258	166
RPR	70	126	125	186	161	152	227
RPS	95	197	187	297	217	136	77

Contd 3.1a: Count of the total number of valid elective episodes generated by Trauma & Orthopaedic waiting lists in South Thames Region BY quarter enrolled BY hospital

Source:

*Hospital Episode Statistics 1994/95, 1993/94 & 1992/93*

Hospital	1993 Q2	1993 Q1	1992 Q4	1992 Q3
RA1	7+363=370	8+281+139=428	1+142+274=417	0+ 29+421=450
RA2	69+283=352	64+221+122=407	36+139+240=415	7+106+260=373
RAV	-	-	-	-
RAX	26+244=270	0+224+ 81=305	1+118+167=286	0+ 42+264=306
RAZ	76+428=504	14+328+109=451	4+188+236=428	6+156+288=450
RCY	6+ 16= 22	0+ 4+ 43= 47	1+ 0+158=159	0+ 0+229=229
RDL	97+425=522	51+296+163=510	39+200+278=517	10+156+371=537
RDM	115+270=385	81+224+ 81=386	45+156+170=371	1+136+212=349
RDR	7+ 5= 12	1+ 8+ 0= 9	2+ 6+ 2= 10	0+ 6+ 7= 13
RDU	106+219=325	47+205+ 83=335	39+194+145=378	4+ 98+176=278
RDV	113+271=384	42+269+ 45=356	6+247+191=444	0+112+344=456
RG1	33+234=267	24+179=203	8+79=87	0+36=36
RG2	56+319=375	36+212=248	33+101=134	10+75=85
RG3	141+355=496	80+281=361	22+252=274	10+173=183
RGU	52+213=265	41+176=217	19+87=106	8+88=96
RGV	26+183=209	11+165=176	1+118=119	1+99=100
RGW	51+139=190	8+98=106	9+56=65	1+39=40
RGX	0+ 94= 94	0+61=61	0+35=35	0+14=14
RGZ	41+276=317	27+164=191	5+88=93	0+52=52
RHE	85+102=187	43+104=147	24+108=132	18+85=103
RHG	11+197=208	3+119=122	1+39=40	1+40=41
RHH	84+247=331	48+265=313	11+169=180	6+90=96
RJ1	97+399=496	86+308=394	48+157=205	6+144=150
RJ2	51+260=311	39+179=218	13+92=105	6+60=66
RJ6	81+310=391	48+365=413	10+217=218	10+152=162
RJ7	37+153=190	15+148=163	4+55=59	6+25=31
RJZ	70+153=223	54+185=239	32+137=169	5+127=132
RN7	42	14	4	3
RPA	86	38	3	2
RPC	3	1	1	0
RPD	64	66	23	0
RPF	107	41	16	7
RPL	93	61	35	11
RPR	119	68	25	7
RPS	33	18	7	2

Table 3.3a: Count of the total number of elective episodes generated by Trauma & Orthopaedic waiting lists in South Thames Region  
BY quarter of admission BY hospital

Specialty	1994 Q4 $\Sigma A$	1994 Q3 $\Sigma A$	1994 Q2 $\Sigma A$	1994 Q1 $\Sigma A$	1993 Q4 $\Sigma A$	1993 Q3 $\Sigma A$	1993 Q2 $\Sigma A$	1993 Q1 $\Sigma A$	1992 Q4 $\Sigma A$	1992 Q3 $\Sigma A$
RA1	852	890	846	765	616	727	714	739	713	794
RA2	860	926	878	873	871	840	738	817	784	697
RAV	-	-	-	-	-	-	-	-	-	-
RAX	699	773	692	672	574	647	656	689	677	759
RAZ	775	878	654	715	765	817	742	766	737	767
RCY	412	431	456	438	444	471	510	337	464	468
RDL	811	831	889	932	792	754	773	723	740	843
RDM	773	741	745	736	723	780	650	571	642	619
RDR	18	15	20	17	23	12	19	17	10	13
RDU	793	732	795	807	667	592	664	564	555	544
RDV	732	947	925	909	778	803	894	851	845	911
RG1	590	616	539	500	483	538	503	48	-	-
RG2	720	763	777	761	775	763	820	61	3	-
RG3	837	772	693	676	627	762	766	72	1	-
RGU	873	904	938	828	779	894	852	95	1	-
RGV	537	565	532	525	520	583	515	35	-	1
RGW	539	584	574	478	531	553	527	33	2	1
RGX	97	87	97	96	103	86	97	2	-	1
RGZ	632	672	650	557	592	666	651	37	1	1
RHE	415	481	418	471	418	399	371	32	1	-
RHG	411	459	452	482	450	432	460	47	-	-
RHH	807	715	741	694	759	744	717	80	-	-
RJ1	879	870	890	909	865	907	919	100	1	-
RJ2	608	598	672	620	529	537	565	44	1	-
RJ6	829	830	846	825	750	861	834	87	2	-
RJ7	678	582	586	605	534	552	579	71	1	-
RJZ	597	708	693	604	532	588	602	41	3	-



Contd 3.3a: Count of the total number of elective episodes generated by Trauma & Orthopaedic waiting lists in South Thames Region  
BY quarter of admission BY hospital

Specialty	1994 Q4 <i>ΣA</i>	1994 Q3 <i>ΣA</i>	1994 Q2 <i>ΣA</i>	1994 Q1 <i>ΣA</i>	1993 Q4 <i>ΣA</i>	1993 Q3 <i>ΣA</i>	1993 Q2 <i>ΣA</i>	1993 Q1 <i>ΣA</i>	1992 Q4 <i>ΣA</i>	1992 Q3 <i>ΣA</i>
RN7	846	821	883	47	1	-	-	-	-	1
RPA	760	943	992	76	-	-	-	-	-	-
RPC	30	22	38	-	-	-	-	-	-	-
RPD	719	698	744	49	-	-	-	-	-	-
RPF	1,116	1,173	1,076	67	1	-	-	-	-	-
RPL	958	947	899	77	1	-	-	-	-	-
RPR	645	648	596	46	2	-	-	-	-	-
RPS	588	519	528	32	1	4	1	-	-	-

Table 3.3b: Count of the total number of non-missing elective episodes generated by Trauma & Orthopaedic waiting lists in South Thames Region  
BY quarter of admission BY hospital

Specialty	1994 Q4	1994 Q3	1994 Q2	1994 Q1	1993 Q4	1993 Q3	1993 Q2	1993 Q1	1992 Q4	1992 Q3
	$\Sigma A$	$\Sigma A$	$\Sigma A$	$\Sigma A$	$\Sigma A$	$\Sigma A$	$\Sigma A$	$\Sigma A$	$\Sigma A$	$\Sigma A$
RA1	542	558	525	449	364	427	414	460	419	498
RA2	361	366	359	393	418	406	359	404	381	351
RAV	-	-	-	-	-	-	-	-	-	-
RAX	330	466	337	333	270	264	259	261	275	357
RAZ	461	530	409	468	466	549	485	503	468	480
RCY	225	226	283	191	221	238	293	100	232	230
RDL	513	501	588	649	502	431	486	461	455	505
RDM	511	448	461	462	439	445	368	330	377	355
RDR	15	13	15	15	17	6	16	16	6	12
RDU	459	413	465	525	362	247	295	277	245	171
RDV	335	445	464	463	325	300	381	364	386	450
RG1	312	297	264	239	248	275	285	14	-	-
RG2	333	410	420	388	394	321	426	12	2	-
RG3	591	515	429	393	403	474	449	31	-	-
RGU	366	372	389	385	299	352	332	28	-	-
RGV	315	318	312	337	326	350	294	19	-	-
RGW	197	182	207	160	174	181	188	0	-	-
RGX	96	85	93	94	103	86	96	2	-	-
RGZ	307	319	319	273	275	353	379	11	-	-
RHE	217	242	174	242	208	133	158	11	-	-
RHG	179	225	188	224	196	197	231	12	-	-
RHH	416	356	338	349	372	329	366	40	-	-
RJ1	478	522	524	544	488	518	507	46	1	-
RJ2	367	314	398	366	221	339	318	15	1	-
RJ6	497	495	505	540	460	507	462	22	-	-
RJ7	370	282	320	324	258	268	273	27	-	-
RJZ	251	311	290	285	260	270	265	16	-	-

Contd 3.3b: Count of the total number of non-missing elective episodes generated by Trauma & Orthopaedic waiting lists in South Thames Region  
BY quarter of admission BY hospital

Specialty	1994 Q4 $\Sigma A$	1994 Q3 $\Sigma A$	1994 Q2 $\Sigma A$	1994 Q1 $\Sigma A$	1993 Q4 $\Sigma A$	1993 Q3 $\Sigma A$	1993 Q2 $\Sigma A$	1993 Q1 $\Sigma A$	1992 Q4 $\Sigma A$	1992 Q3 $\Sigma A$
RN7	400	377	416	13	-	-	-	2	-	-
RPA	400	498	523	33	-	-	-	-	-	-
RPC	29	22	35	0	-	-	-	-	-	-
RPD	367	312	376	10	-	-	-	-	-	-
RPF	680	748	623	26	-	-	-	-	-	-
RPL	565	516	506	22	-	-	-	-	-	-
RPR	354	318	273	10	1	-	-	-	-	-
RPS	329	287	329	18	-	1	1	-	-	-

Table 3.3c: KH06 admissions generated by Trauma & Orthopaedic waiting lists in South Thames Region  
BY quarter of admission BY hospital

Admitted:	1994 Q4	1994 Q3	1994 Q2	1994 Q1	1993 Q4	1993 Q3	1993 Q2	1993 Q1	1992 Q4	1992 Q3
Hospital	$\Sigma A$	$\Sigma A$	$\Sigma A$	$\Sigma A$	$\Sigma A$	$\Sigma A$	$\Sigma A$	$\Sigma A$	$\Sigma A$	$\Sigma A$
RA1	503	524	460	431	332	405	368	411	372	461
RA2	355	351	333	375	397	398	359	395	374	346
RAV	-	-	-	-	-	-	-	515	454	515
RAX	311	440	322	325	265	259	251	248	262	332
RAZ	442	506	395	447	440	533	473	491	443	399
RCY	102	102	-	-	-	-	-	-	-	-
RDL	495	481	559	624	322	404	446	443	436	448
RDM	538	474	493	486	473	478	401	340	399	334
RDR	12	12	12	9	17	2	12	16	5	11
RDU	347	328	377	428	300	242	294	275	237	168
RDV	324	440	451	446	314	277	352	342	373	425
RG1	310	301	263	230	230	252	250	-	-	-
RG2	317	357	343	255	255	196	239	-	-	-
RG3	486	463	362	316	316	365	359	-	-	-
RGU	286	275	251	216	216	246	203	-	-	-
RGV	316	311	308	307	347	352	278	-	-	-
RGW	195	177	184	113	113	111	196	-	-	-
RGX	94	86	93	103	103	84	84	-	-	-
RGZ	314	317	330	273	273	353	380	-	-	-
RHE	208	222	159	224	189	119	153	-	-	-
RHG	176	222	177	216	190	191	223	-	-	-
RHH	382	330	305	330	354	305	334	-	-	-
RJ1	457	476	463	482	448	256	190	-	-	-
RJ2	364	690	396	248	248	325	255	-	-	-
RJ6	451	450	466	516	424	502	451	-	-	-
RJ7	350	261	301	306	142	136	134	-	-	-
RJZ	100	100	288	97	97	250	249	-	-	-

Contd 3.3c: KH06 admissions generated by Trauma & Orthopaedic waiting lists in South Thames Region  
 BY quarter of admission BY hospital

Admitted:	1994 Q4	1994 Q3	1994 Q2	1994 Q1	1993 Q4	1993 Q3	1993 Q2	1993 Q1	1992 Q4	1992 Q3
Hospital	$\Sigma A$	$\Sigma A$	$\Sigma A$	$\Sigma A$	$\Sigma A$	$\Sigma A$	$\Sigma A$	$\Sigma A$	$\Sigma A$	$\Sigma A$
RN7	129	77	163	-	-	-	-	-	-	-
RPA	373	474	489	-	-	-	-	-	-	-
RPC	29	22	34	-	-	-	-	-	-	-
RPD	344	284	344	-	-	-	-	-	-	-
RPF	570	612	506	-	-	-	-	-	-	-
RPL	491	455	429	-	-	-	-	-	-	-
RPR	344	306	262	-	-	-	-	-	-	-
RPS	326	276	327	-	-	-	-	-	-	-



Figure 6.1: Lexis diagrams describing imputation from KH06, KH07A and KH07 data and from valid elective episodes. (General Surgery (100), all NHS hospitals in England)

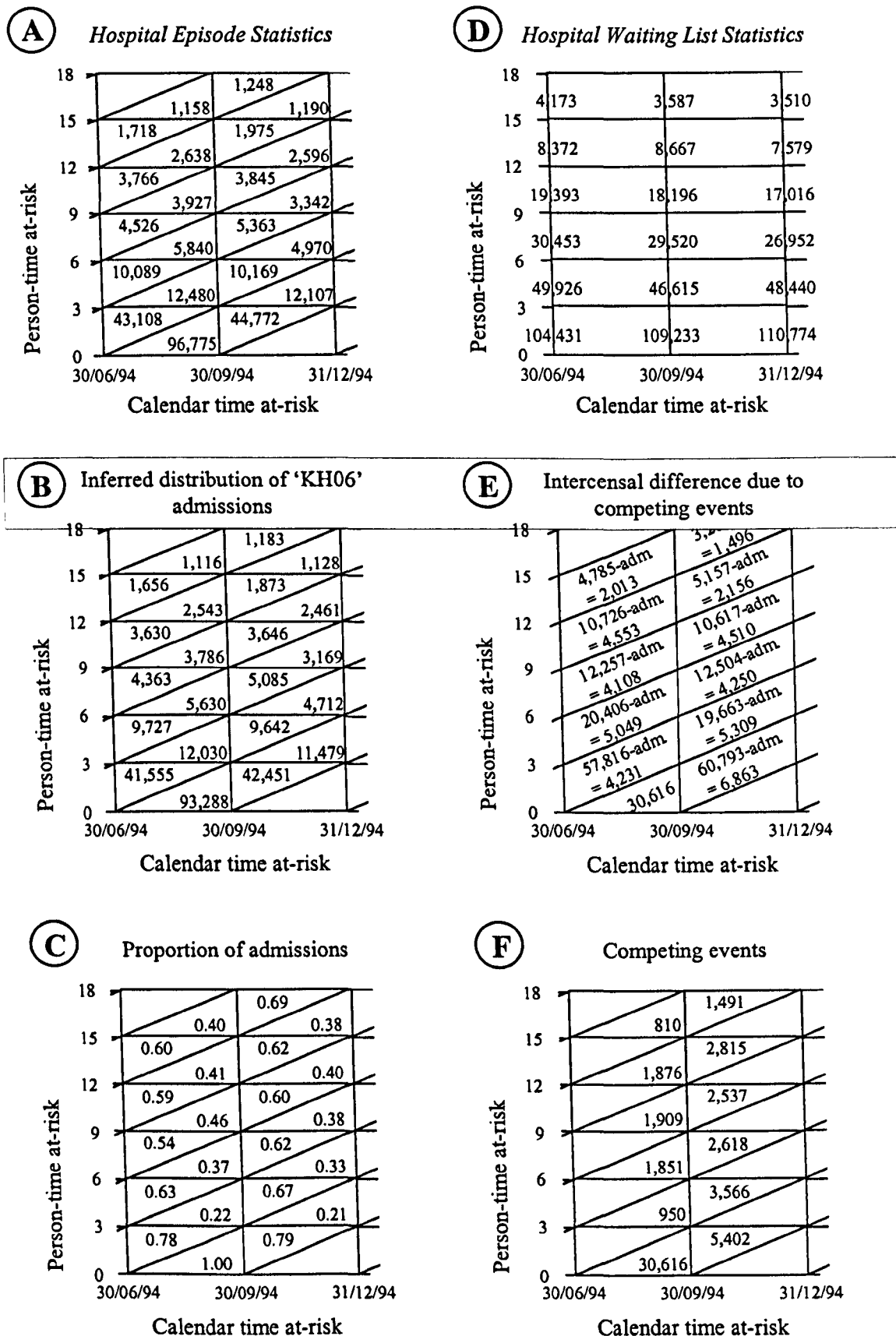

Figure 6.1: Lexis diagrams describing imputation from KH06, KH07A and KH07 data and from valid elective episodes. (Urology (101), all NHS hospitals in England)

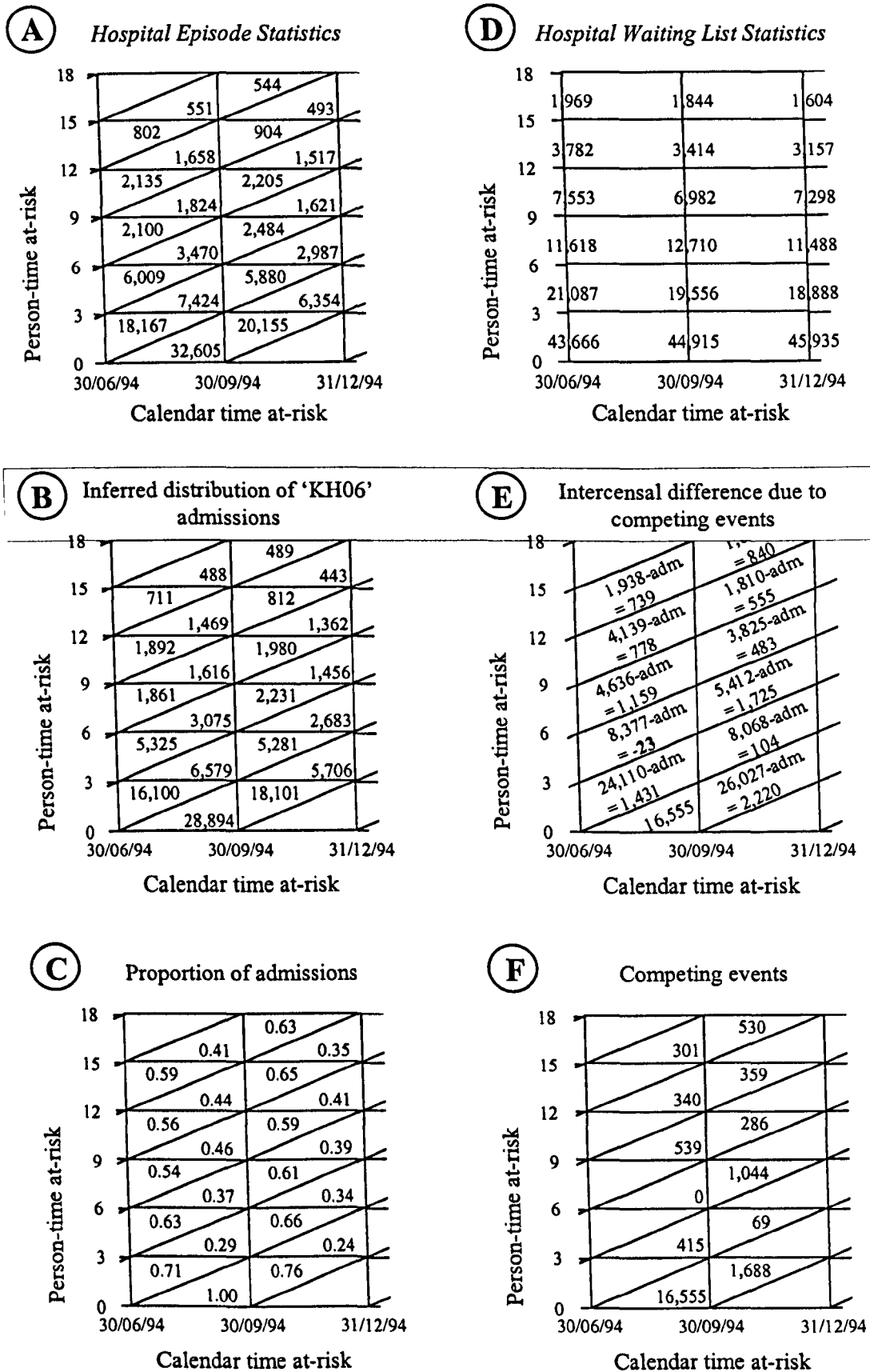



Figure 6.1: Lexis diagrams describing imputation from KH06, KH07A and KH07 data and from valid elective episodes. (Trauma & Orthopaedics (110), all NHS hospitals in England)

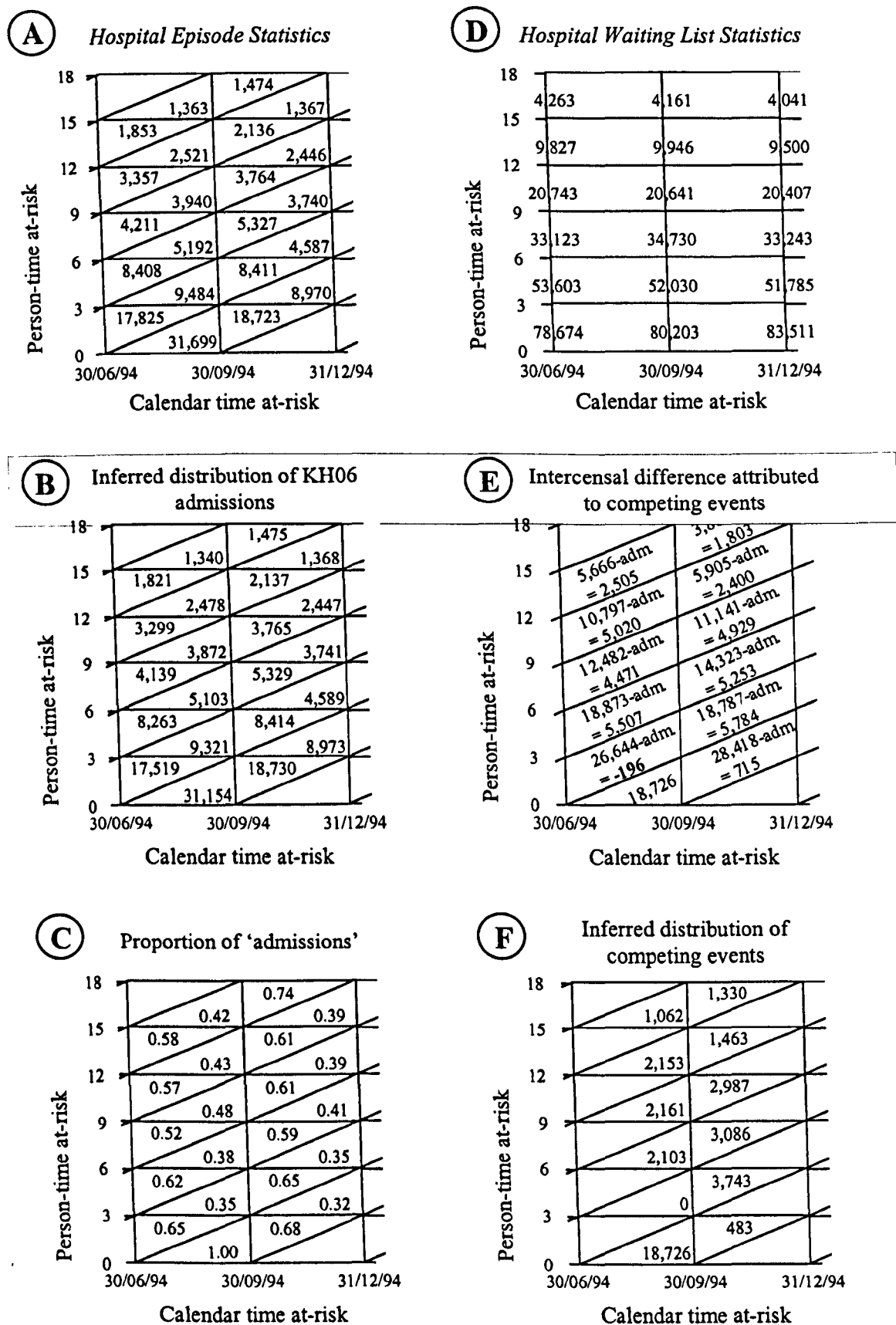

Figure 6.1: Lexis diagrams describing imputation from KH06, KH07A and KH07 data and from valid elective episodes. (ENT (120), all NHS hospitals in England)

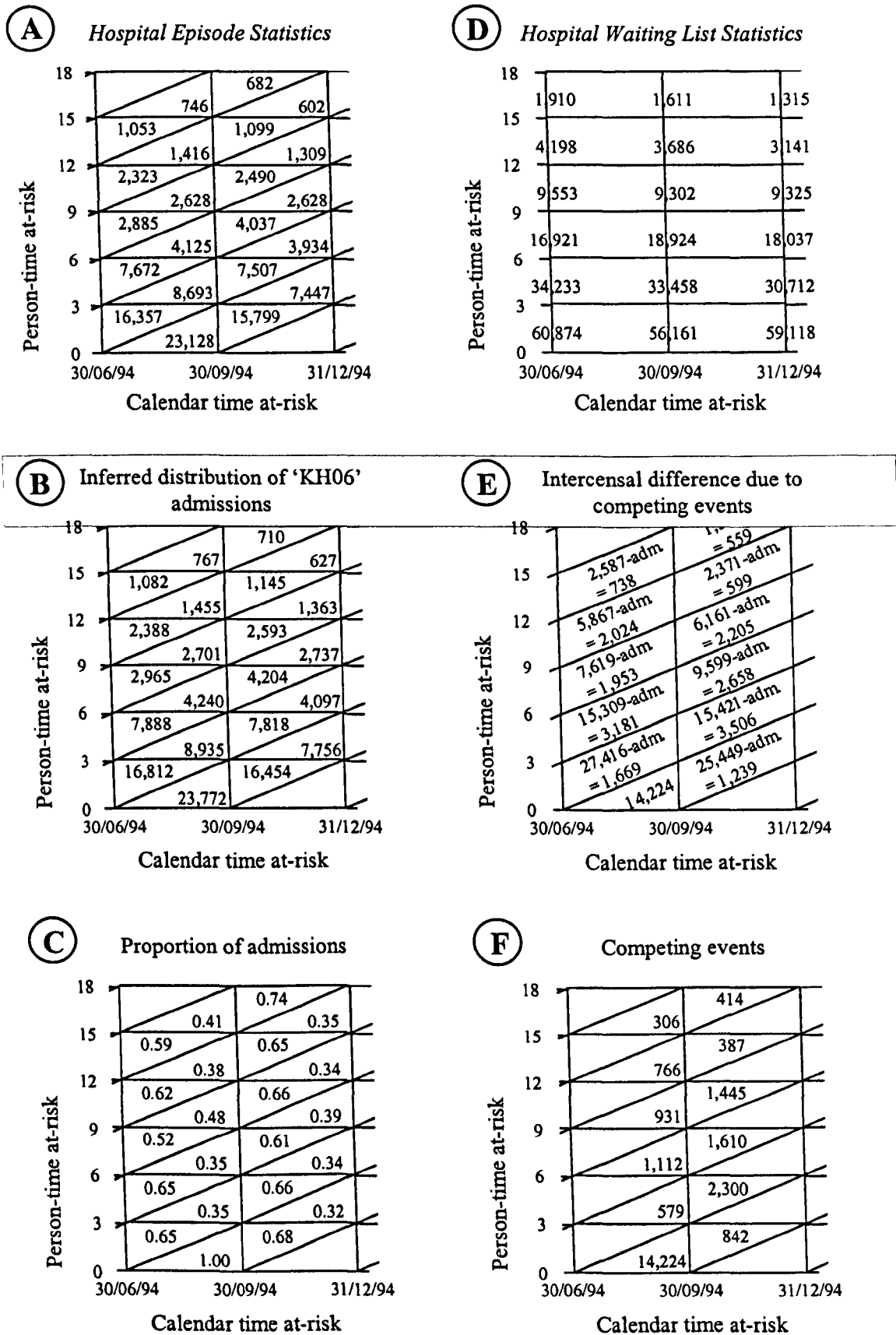

Figure 6.1: Lexis diagrams describing imputation from KH06, KH07A and KH07 data and from valid elective episodes. (Ophthalmology (130), all NHS hospitals in England)

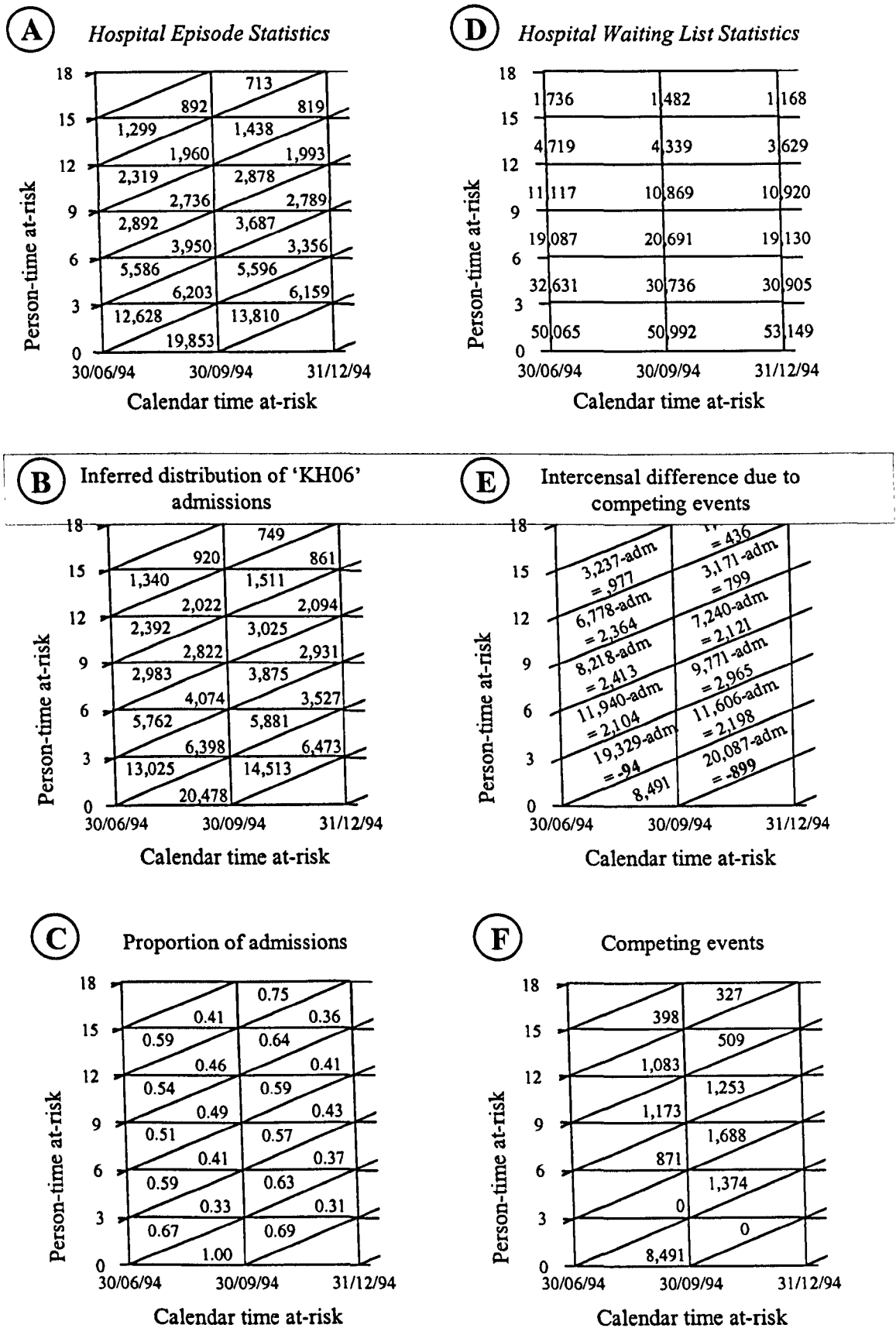

Figure 6.1: Lexis diagrams describing imputation from KH06, KH07A and KH07 data and from valid elective episodes. (Oral Surgery (140), all NHS hospitals in England)

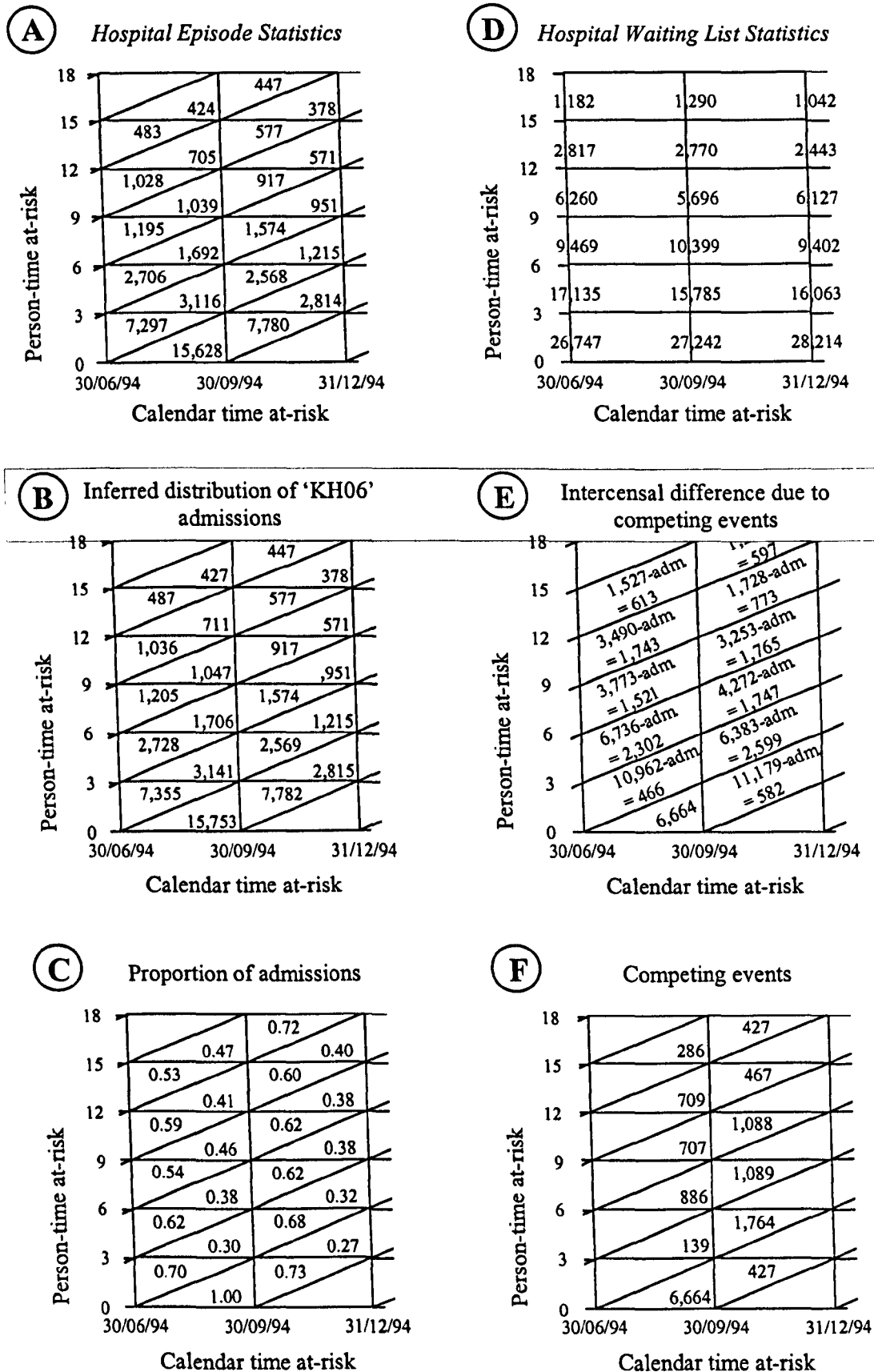

Figure 6.1: Lexis diagrams describing imputation from KH06, KH07A and KH07 data and from valid elective episodes. (Plastic Surgery (160), all NHS hospitals in England)

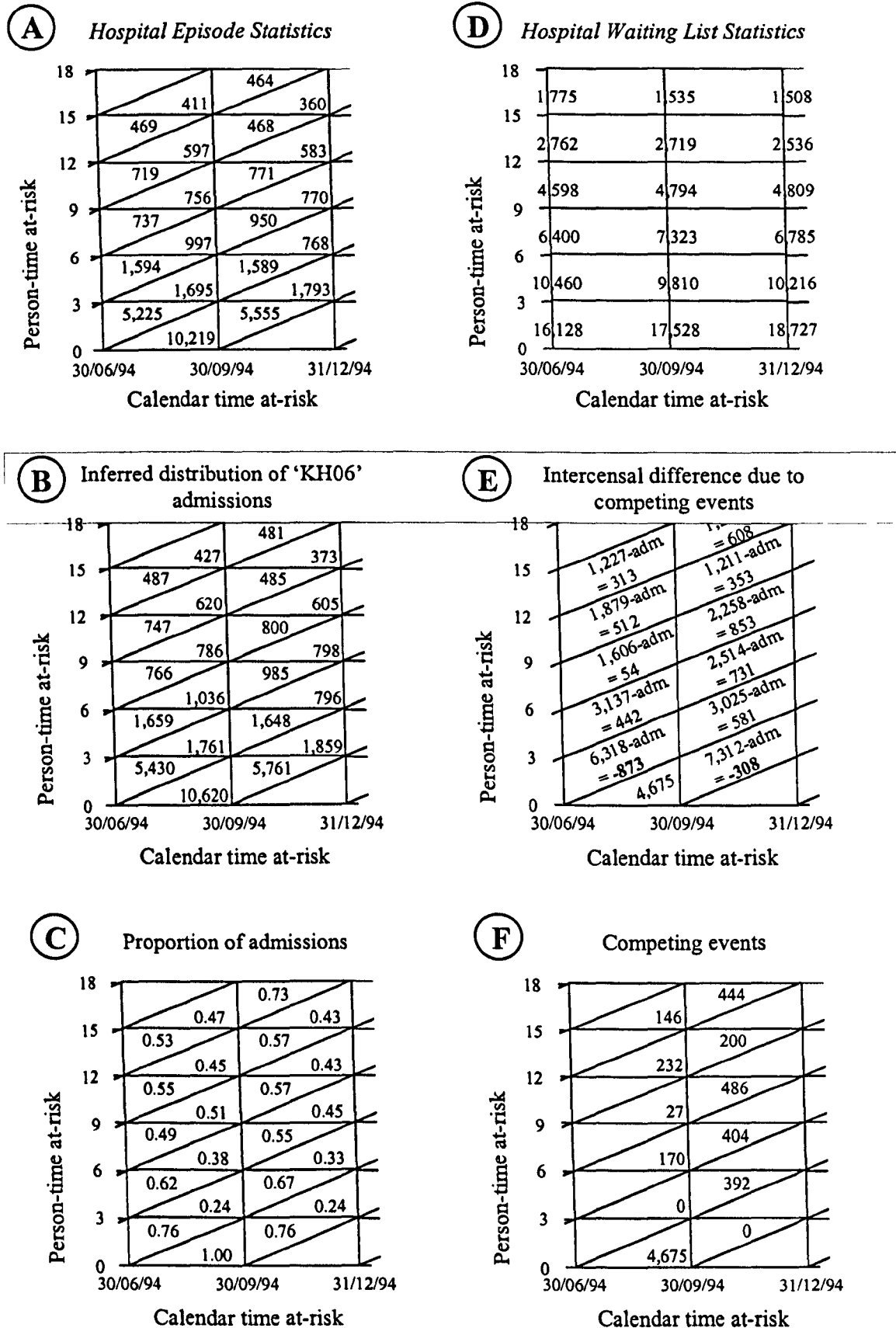

Figure 6.1: Lexis diagrams describing imputation from KH06, KH07A and KH07 data and from valid elective episodes. (Cardiothoracic Surgery (170), all NHS hospitals in England)

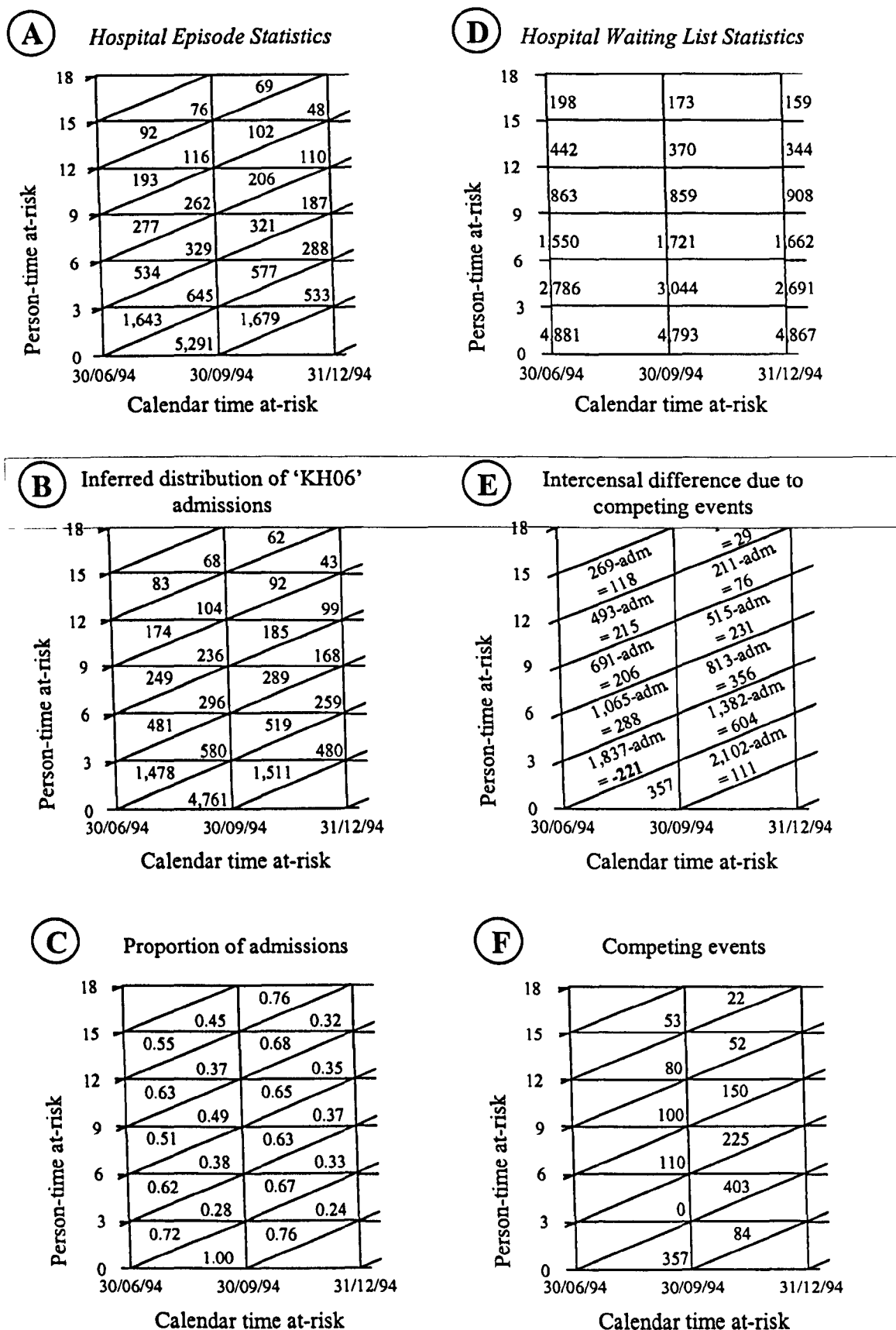

Figure 6.1: Lexis diagrams describing imputation from KH06, KH07A and KH07 data and from valid elective episodes. (General Medicine (300), all NHS hospitals in England)

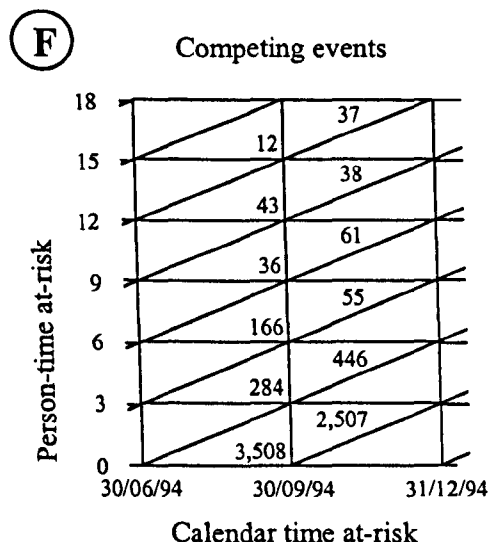
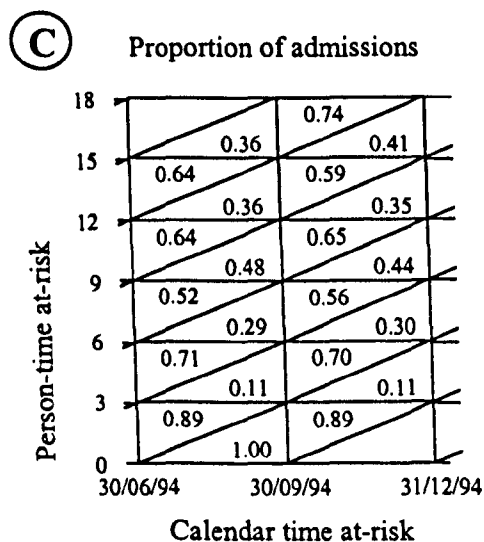
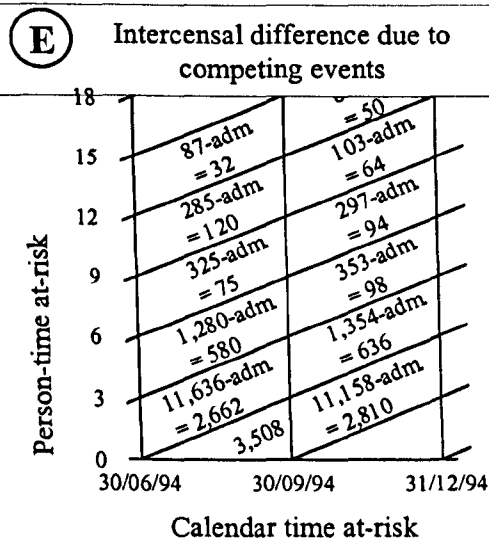
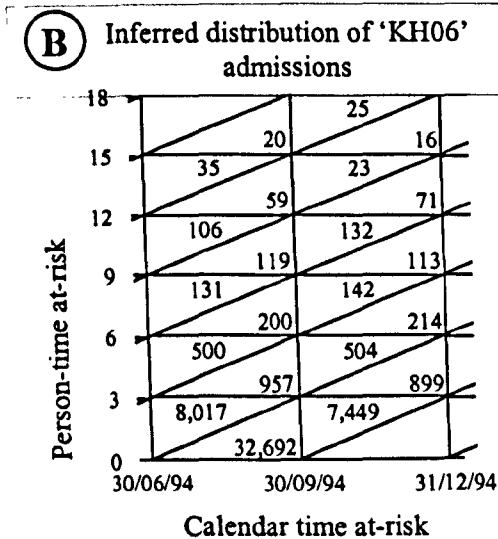
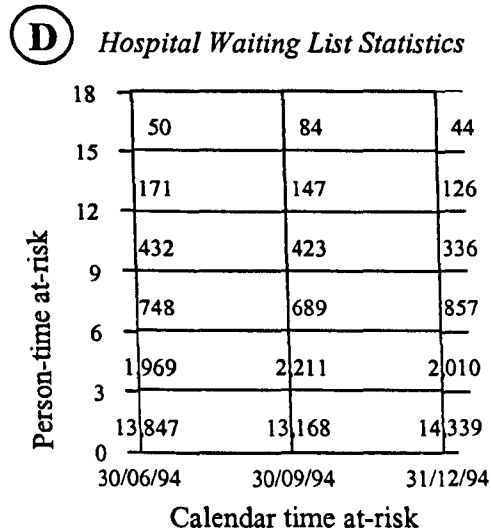
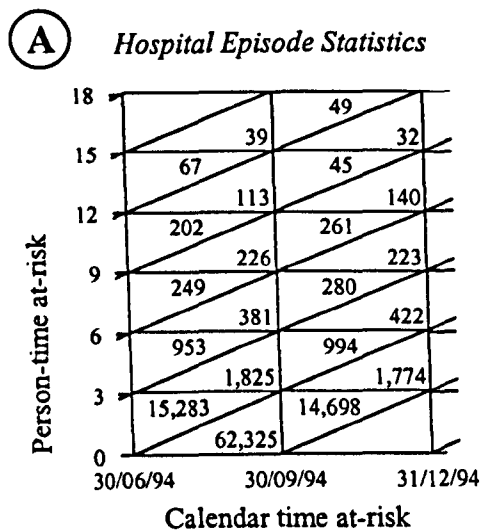

Figure 6.1: Lexis diagrams describing imputation from KH06, KH07A and KH07 data and from valid elective episodes. (Cardiology (320), all NHS hospitals in England)

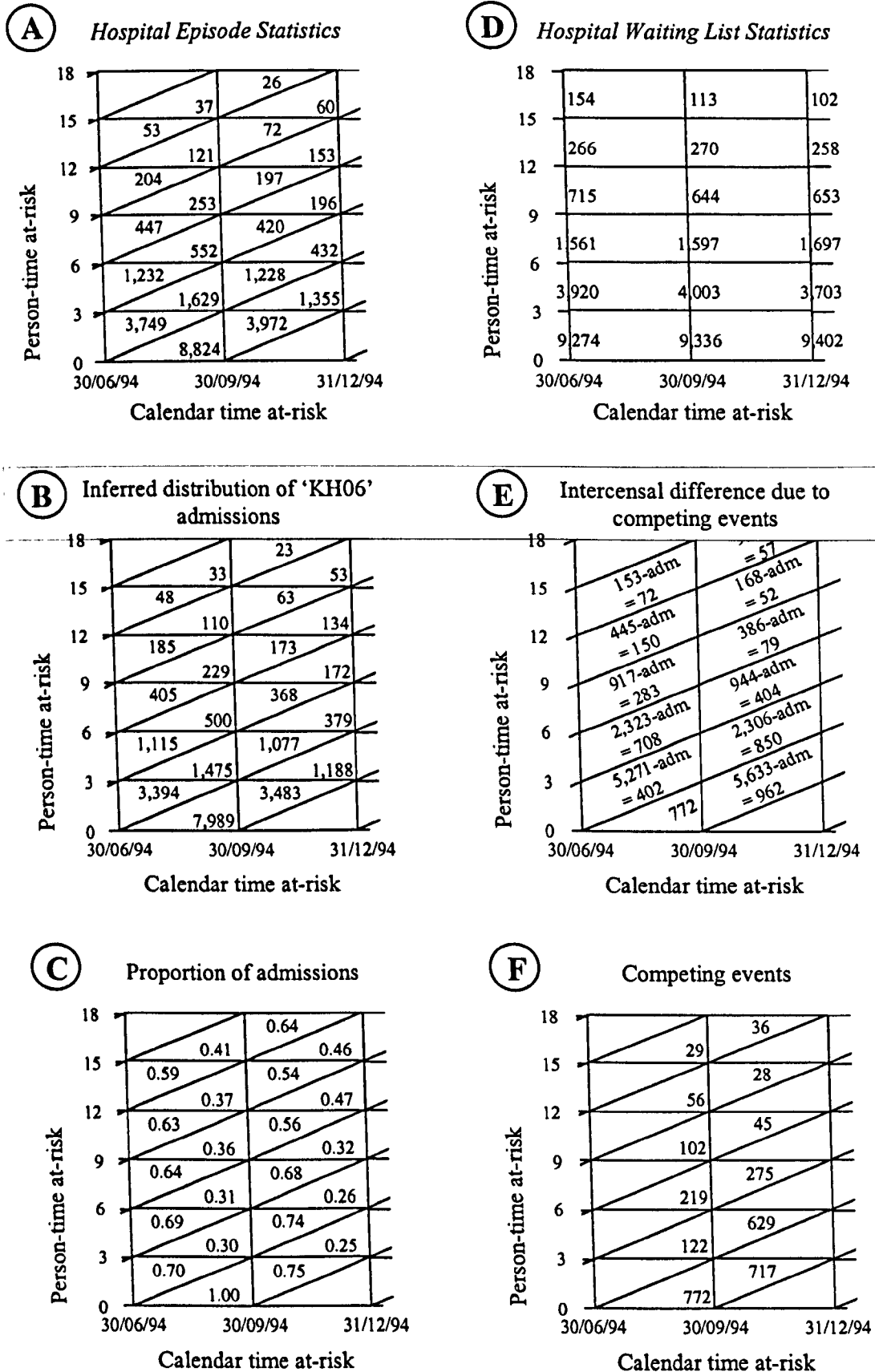



Figure 6.1: Lexis diagrams describing imputation from KH06, KH07A and KH07 data and from valid elective episodes. (Gynaecology (502), all NHS hospitals in England)

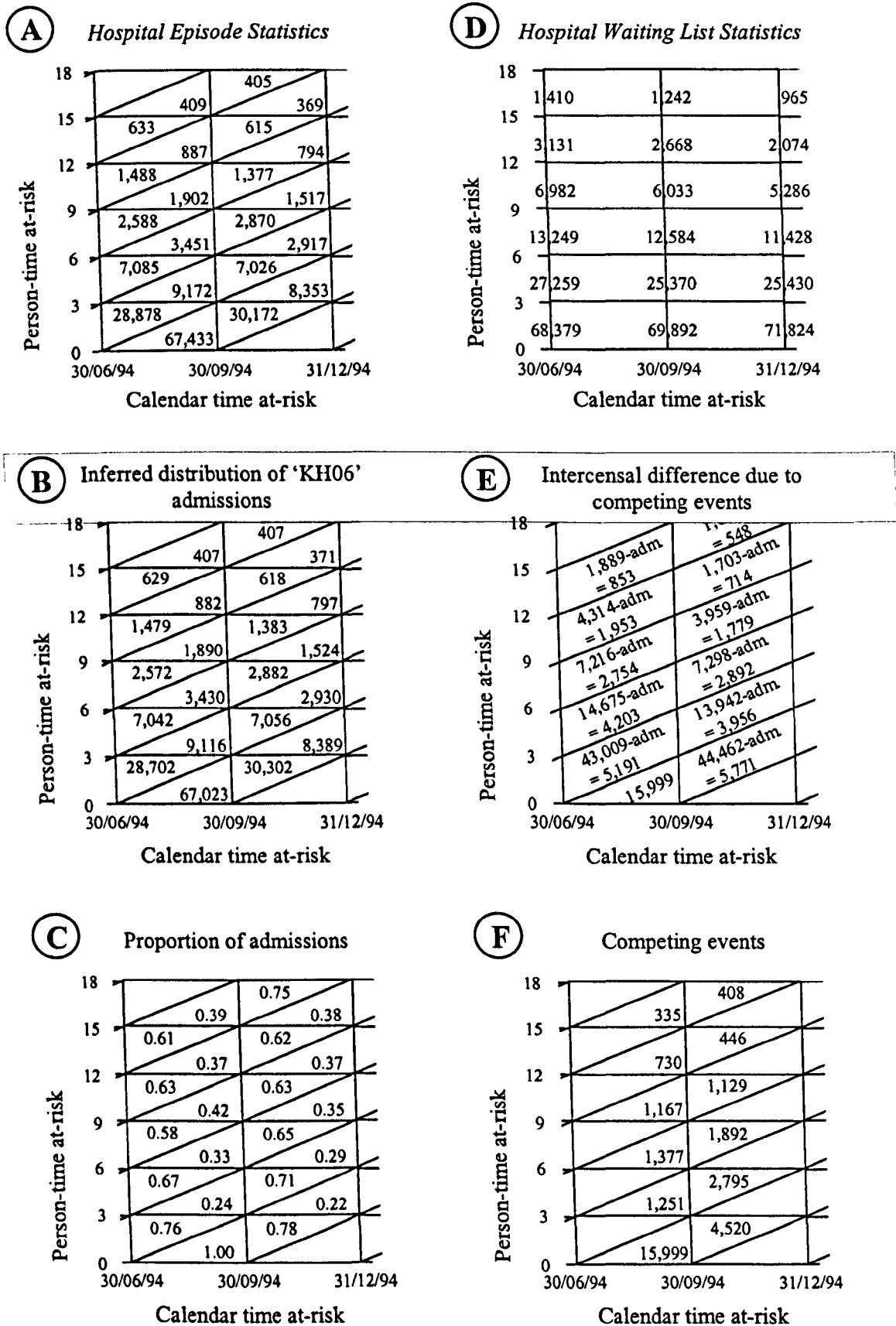

Table 6.8a: Internal consistency of KH06, KH07A and KH07 returns with elective episodes for period 1 July to 31 December 1994 inclusive  
Trauma & Orthopaedics BY hospital (South Thames Region)

Code	Entering the group 'at-risk' of admission (E)				Error of Closure E-L (% = [E-L]/E*100)	Leaving the group 'at-risk' of admission (L)						
	Censused 30.06.94 [KH07]	'Newly- Recruited' [KH06]	'Reset-to- zero' *	'Re- instated' †		Admitted ‡	Removed [KH06]	Self-deferred [KH07A]	Failed [KH06]	Medic. Defrrd	Suspended [KH06]	Censused 31.12.94 [KH07]
RA1	1,025	1,319	240	0	-130 (-5.03%)	1,100	240	233	7	-	0	1,134
RA2	1,120	865	141	0	-110 (-5.17%)	727	219	138	3	-	0	1,149
RAX	741	931	122	0	-47 (-2.62%)	796	187	121	1	-	0	736
RAZ	975	978	110	0	-73 (-3.54%)	991	144	104	6	-	0	891
RCY	0	216	18	0	-1,028 (-439%)	451	4	0	18	-	0	789
RDL	1,111	1,661	89	0	-58 (-2.03%)	1,014	632	49	40	-	0	1,184
RDM	1,659	1,272	19	0	53 (1.80%)	959	193	9	10	-	0	1,726
RDR	73	34	3	0	-2 (-1.82%)	28	13	1	2	-	0	68
RDU	1,140	818	223	0	-251 (-11.51%)	872	139	219	4	-	0	1,198
RDV	1,128	1,133	150	0	-47 (-1.95%)	780	158	148	2	-	0	1,370
RG1	668	862	17	0	133 (8.60%)	609	29	4	13	-	0	759
RG2	805	573	85	0	-248 (-16.95%)	743	87	72	13	-	0	796
RG3	1,543	1,194	482	100	-211 (-6.36%)	1,106	447	427	55	-	100	1,395
RGU	1,003	935	82	0	-242 (-11.98%)	738	279	0	82	-	0	1,163
RGV	497	616	60	44	-8 (-0.01%)	633	81	23	37	-	44	407
RGW	540	564	97	9	-7 (-0.01%)	379	189	45	52	-	9	543
RGX	0	180	2	0	-127 (-69.78%)	181	26	2	0	-	0	100
RGZ	691	858	94	72	5 (0.00%)	626	185	94	0	-	72	733
RHE	893	549	85	0	-26 (-1.70%)	459	85	76	9	-	0	924
RHG	315	450	127	0	-27 (-3.03%)	404	97	117	10	-	0	291
RHH	975	877	100	0	-47 (-2.41%)	772	155	100	0	-	0	972
RJ1	1,391	1,369	198	97	-107 (-3.50%)	1,000	528	164	34	-	97	1,339
RJ2	873	1,290	438	0	512 (19.68%)	681	121	293	145	-	0	849
RJ6	1,111	1,122	388	0	-164 (-6.26%)	992	254	359	29	-	0	1,151
RJ7	502	800	230	0	-117 (-7.64%)	652	200	195	35	-	0	567
RJZ	850	182	12	0	-357 (-34.20%)	562	36	4	8	-	0	791
RN7	1,041	470	295	0	-705 (-39.04%)	777	163	276	19	-	0	1,276
RPA	1,078	860	349	0	-256 (-11.19%)	898	164	334	15	-	0	1,132

Contd 6.8a: Internal consistency of KH06, KH07A and KH07 returns elective episodes for period 1 July to 31 December 1994 inclusive  
Trauma & Orthopaedics BY hospital (South Thames Region)

Code	Entering the group 'at-risk' of admission (E)				Error of Closure E-L (% = [E-L]/E*100)	Leaving the group 'at-risk' of admission (L)						
	Censused 30.06.94 [KH07]	'Newly- Recruited' [KH06]	'Reset-to- zero' *	'Re- instated' †		Admitted ‡	Removed [KH06]	Self-deferred [KH07A]	Failed [KH06]	Medic. Defr'd	Suspended [KH06]	Censused 31.12.94 [KH07]
RPC	24	70	11	2	-6 ( -5.61%)	51	14	6	5	-	2	35
RPD	969	730	27	0	-51 ( -2.95%)	679	65	27	0	-	0	1,006
RPF	1,531	2,158	206	0	-256 ( -6.57%)	1,428	868	76	130	-	0	1,649
RPL	1,489	1,186	157	0	-140 ( -4.94%)	1,081	268	157	0	-	0	1,466
RPR	1,446	903	97	0	-94 ( -3.84%)	672	189	87	10	-	0	1,582
RPS	680	721	81	0	-18 ( -1.21%)	616	101	81	0	-	0	702

- \* Estimated as the number who self-deferred or failed-to-attend for admission to hospital that quarter.  
† Estimated as the number temporarily suspended or deferred on medical grounds in the same quarter.  
‡ The number of elective *Hospital Episode Statistics* with enrolment dates, valid or '15.10.1582'

Note: The numbers in italics contribute nothing to the difference between E and L so the 'error of closure' is really a comparison of columns 2 & 3 with columns 7, 8 & 13.

Table 6.9a: Ratio of elective episodes with or without enrolment dates to elective episodes with enrolment dates  
Trauma & Orthopaedics BY quarter of admission BY hospital (South Thames Region)

Hospital	1994 Q4	1994 Q3	1994 Q2	1994 Q1	1993 Q4	1993 Q3	1993 Q2	1993 Q1	1992 Q4	1992 Q3
RA1	1.5720	1.5950	1.6114	1.7038	1.6923	1.7026	1.7246	1.6065	1.7017	1.5944
RA2	2.3823	2.5301	2.4457	2.2214	2.0837	2.0690	2.0557	2.0223	2.0577	1.9858
RAV	-	-	-	-	-	-	-	-	-	-
RAX	2.1182	1.6588	2.0534	2.0180	2.1259	2.4508	2.5328	2.6398	2.4618	2.1261
RAZ	1.6811	1.6566	1.5990	1.5278	1.6416	1.4882	1.5299	1.5229	1.5748	1.5979
RCY	1.8311	1.9071	1.6113	2.2932	2.0090	1.9790	1.7406	3.3700	2.0000	2.0348
RDL	1.5809	1.6587	1.5119	1.4361	1.5777	1.7494	1.5905	1.5683	1.6264	1.6693
RDM	1.5127	1.6540	1.6161	1.5931	1.6469	1.7528	1.7663	1.7303	1.7029	1.7437
RDR	1.2000	1.1500	1.3300	1.1300	1.3500	2.0000	1.1900	1.0600	1.67	1.08
RDU	1.7277	1.7724	1.7097	1.5371	1.8425	2.3968	2.2508	2.0360	2.2653	3.1813
RDV	2.1851	2.1281	1.9935	1.9633	2.3938	2.6767	2.3465	2.3379	2.1891	2.0244
RG1	1.8910	2.0741	2.0417	2.0921	1.9476	1.9564	1.7649			
RG2	2.1622	1.8610	1.8500	1.9613	1.9670	2.3769	1.9249			
RG3	1.4162	1.4990	1.6154	1.7201	1.5558	1.6076	1.7060			
RGU	2.3852	2.4301	2.4113	2.1506	2.6054	2.5398	2.5663			
RGV	1.7048	1.7767	1.7051	1.5579	1.5951	1.6657	1.7517			
RGW	2.7360	3.2088	2.7729	2.9875	3.0517	3.0552	2.8032			
RGX	1.0104	1.0235	1.0430	1.0213	1.0000	1.0000	1.0104			
RGZ	2.0586	2.1066	2.0376	2.0403	2.1527	1.8867	1.7177			
RHE	1.9124	1.9876	2.4023	1.9463	2.0096	3.0000	2.3481			
RHG	2.2961	2.0400	2.4043	2.1518	2.2959	2.1929	1.9913			
RHH	1.9399	2.0084	2.1923	1.9885	2.0403	2.2614	1.9590			
RJ1	1.8389	1.6667	1.6985	1.6710	1.7725	1.7510	1.8126			
RJ2	1.6567	1.9045	1.6884	1.6940	2.3937	1.5841	1.7767			
RJ6	1.6680	1.6768	1.6752	1.5278	1.6304	1.6982	1.8052			
RJ7	1.8324	2.0638	1.8313	1.8673	2.0698	2.0597	2.1209			
RJZ	2.3785	2.2765	2.3897	2.1193	2.0462	2.1778	2.2717			
RN7	2.1150	2.1777	2.1226							
RPA	1.9000	1.8936	1.8967							
RPC	1.0300	1.0000	1.0900							
RPD	1.9591	2.2372	1.9787							

Contd 6.9a: Ratio of elective episodes with or without enrolment dates to elective episodes with enrolment dates  
 Trauma & Orthopaedics BY quarter of admission BY hospital (South Thames Region)

Hospital	1994 Q4	1994 Q3	1994 Q2	1994 Q1	1993 Q4	1993 Q3	1993 Q2	1993 Q1	1992 Q4	1992 Q3
RPD	1.9591	2.2372	1.9787							
RPF	1.6412	1.5682	1.7271							
RPL	1.6956	1.8353	1.7767							
RPR	1.8220	2.0377	2.1832							
RPS	1.7872	1.8084	1.6049							



APRAX.SPS

Extract from an SPSS batch file which counts the number of 'first-active-waits' at-risk of 'first-selection' at each 'time-since-enrolment' between 1 July and 31 December 1994 and the number of 'first-selections' observed as a result.

GET

```
FILE='l:\oraxwk.sav'.
EXECUTE .
RECODE
  status2
  ('IP ADM'=1) ('PREADM ***'=1) ('PREADM TCI'=1) (ELSE=0) INTO status.
VARIABLE LABELS status 'Admitted electively or censored'.
EXECUTE .
SAVE OUTFILE='l:\aprax.sav' /KEEP=status strt1 strt2 /COMPRESSED.
```

GET

```
FILE='l:\aprax.sav'.
EXECUTE .
IF (XDATE.DATE(strt1) >= (DATE.DMY(01,07,1994) - TIME.DAYS(0))
  & XDATE.DATE(strt1) <= (DATE.DMY(31,12,1994) - TIME.DAYS(0))
  & XDATE.DATE(strt2) >= (XDATE.DATE(strt1) + TIME.DAYS(0))) risk000 = 0 .
EXECUTE .
IF (XDATE.DATE(strt1) >= (DATE.DMY(01,07,1994) - TIME.DAYS(0))
  & XDATE.DATE(strt1) <= (DATE.DMY(31,12,1994) - TIME.DAYS(0))
  & XDATE.DATE(strt2) = (XDATE.DATE(strt1) + TIME.DAYS(0)) & ABS(status) = 1) risk000 =
1 .
EXECUTE .
IF ...

IF ...

IF ...

IF (XDATE.DATE(strt1) >= (DATE.DMY(01,07,1994) - TIME.DAYS(371))
  & XDATE.DATE(strt1) <= (DATE.DMY(31,12,1994) - TIME.DAYS(371))
  & XDATE.DATE(strt2) >= (XDATE.DATE(strt1) + TIME.DAYS(371))) risk371 = 0 .
EXECUTE .
IF (XDATE.DATE(strt1) >= (DATE.DMY(01,07,1994) - TIME.DAYS(371))
  & XDATE.DATE(strt1) <= (DATE.DMY(31,12,1994) - TIME.DAYS(371))
  & XDATE.DATE(strt2) = (XDATE.DATE(strt1) + TIME.DAYS(371)) & ABS(status) = 1) risk371
= 1 .
EXECUTE .
GET
FILE='l:\aprax.sav'.
EXECUTE .
IF (XDATE.DATE(strt1) >= DATE.DMY(01,07,1994) & XDATE.DATE(strt1) <=
DATE.DMY(31,12,1994)) qtr9434 = 1 .
EXECUTE .
IF (XDATE.DATE(strt1) <= DATE.DMY(30,06,1994) & MISSING(strt2)=1)
qtr9434 = 1 .
EXECUTE .
IF (XDATE.DATE(strt1) <= DATE.DMY(30,06,1994) & MISSING(strt2)=0 &
XDATE.DATE(strt2) >= DATE.DMY(01,07,1994)) qtr9434 = 1 .
EXECUTE .
IF (XDATE.DATE(strt2) < DATE.DMY(01,07,1994)) qtr9434 = 0 .
EXECUTE .
IF (XDATE.DATE(strt1) > DATE.DMY(31,12,1994)) qtr9434 = 0 .
```

```

EXECUTE .
VARIABLE LABELS qtr9434 ""Third & Fourth Quarters of 1994" .
EXECUTE .
VALUE LABELS qtr9434
0 "No"
1 "Yes".
SAVE OUTFILE='l:\aprax.sav' /COMPRESSED.

GET
FILE='l:\aprax.sav'.
EXECUTE .
FILTER OFF.
USE ALL.
SELECT IF(ABS(qtr9434) = 1).
EXECUTE .
AGGREGATE
/OUTFILE=*
/BREAK=qtr9434
/m000 = MEAN(risk000) / . / . / . /m371 = MEAN(risk371) /N_BREAK=N.
SAVE TRANSLATE OUTFILE='l:\apraxmn.xls'
/TYPE=XLS /MAP /REPLA /FIELDNAMES.

GET
FILE='l:\aprax.sav'.
EXECUTE .
FILTER OFF.
USE ALL.
SELECT IF(ABS(qtr9434) = 1).
EXECUTE .
AGGREGATE
/OUTFILE=*
/BREAK=qtr9434
/a000 = SUM(risk000) / . / . / . /a371 = SUM(risk371) /N_BREAK=N.
SAVE TRANSLATE OUTFILE='l:\apraxsm.xls'
/TYPE=XLS /MAP /REPLA /FIELDNAMES.

GET
FILE='l:\aprax.sav'.
EXECUTE .
FILTER OFF.
USE ALL.
SELECT IF(ABS(qtr9434) = 1).
EXECUTE .
AGGREGATE
/OUTFILE=*
/BREAK=qtr9434
/n000 = N(risk000) / . / . / . /n371 = N(risk371) /N_BREAK=N.
SAVE TRANSLATE OUTFILE='l:\apraxn.xls'
/TYPE=XLS /MAP /REPLA /FIELDNAMES.

```



CPRAX.SPS

Extract from an SPSS batch file which identifies the 'first-active-waits' at-risk of 'first-selection' at each 'time-since-enrolment' between 1 July and 31 December 1994 and counts the number ending in temporary or permanent removal from the waiting list.

```
GET
  FILE='l:\oraxwk.sav'.
EXECUTE .
RECODE
  status2
  ('WL CANC'=1) ('WL SUSP'=1) ('WL DEFER'=1) (ELSE=0) INTO status.
VARIABLE LABELS status 'Temporarily or permanently removed or else censored'.
EXECUTE .
SAVE OUTFILE='l:\cprax.sav' /KEEP=status strt1 strt2 /COMPRESSED.

GET
  FILE='l:\cprax.sav'.
EXECUTE .
IF (XDATE.DATE(strt1) >= (DATE.DMY(01,07,1994) - TIME.DAYS(0))
  & XDATE.DATE(strt1) <= (DATE.DMY(31,12,1994) - TIME.DAYS(0))
  & XDATE.DATE(strt2) >= (XDATE.DATE(strt1) + TIME.DAYS(0)))          crisk000 = 0 .
EXECUTE .
IF (XDATE.DATE(strt1) >= (DATE.DMY(01,07,1994) - TIME.DAYS(0))
  & XDATE.DATE(strt1) <= (DATE.DMY(31,12,1994) - TIME.DAYS(0))
  & XDATE.DATE(strt2) = (XDATE.DATE(strt1) + TIME.DAYS(0)) & ABS(status) = 1) crisk000 =
1 .
EXECUTE .
IF ...

IF ...

IF ...

IF (XDATE.DATE(strt1) >= (DATE.DMY(01,07,1994) - TIME.DAYS(371))
  & XDATE.DATE(strt1) <= (DATE.DMY(31,12,1994) - TIME.DAYS(371))
  & XDATE.DATE(strt2) >= (XDATE.DATE(strt1) + TIME.DAYS(371)))          crisk371 = 0 .
EXECUTE .
IF (XDATE.DATE(strt1) >= (DATE.DMY(01,07,1994) - TIME.DAYS(371))
  & XDATE.DATE(strt1) <= (DATE.DMY(31,12,1994) - TIME.DAYS(371))
  & XDATE.DATE(strt2) = (XDATE.DATE(strt1) + TIME.DAYS(371)) & ABS(status) = 1) crisk371
= 1 .
EXECUTE .
GET
  FILE='l:\cprax.sav'.
EXECUTE .
IF (XDATE.DATE(strt1) >= DATE.DMY(01,07,1994) & XDATE.DATE(strt1) <=
DATE.DMY(31,12,1994)) qtr9434 = 1 .
EXECUTE .
IF (XDATE.DATE(strt1) <= DATE.DMY(30,06,1994) & MISSING(strt2)=1)
  qtr9434 = 1 .
EXECUTE .
IF (XDATE.DATE(strt1) <= DATE.DMY(30,06,1994) & MISSING(strt2)=0 &
  XDATE.DATE(strt2) >= DATE.DMY(01,07,1994)) qtr9434 = 1 .
EXECUTE .
IF (XDATE.DATE(strt2) < DATE.DMY(01,07,1994)) qtr9434 = 0 .
EXECUTE .
IF (XDATE.DATE(strt1) > DATE.DMY(31,12,1994)) qtr9434 = 0 .
```

```
EXECUTE .  
VARIABLE LABELS qtr9434 "Third & Fourth Quarters of 1994" .  
EXECUTE .  
VALUE LABELS qtr9434  
0 "No"  
1 "Yes".  
SAVE OUTFILE='I:\cprax.sav' /COMPRESSED.
```

```
GET  
FILE='I:\cprax.sav'.  
EXECUTE .  
FILTER OFF.  
USE ALL.  
SELECT IF(ABS(qtr9434) = 1).  
EXECUTE .  
AGGREGATE  
/OUTFILE=*  
/BREAK=qtr9434  
/c000 = SUM(crisk000) / . / . /c371 = SUM(crisk371) /N_BREAK=N.  
SAVE TRANSLATE OUTFILE='I:\cpraxsc.xls'  
/TYPE=XLS /MAP /REPLA /FIELDNAMES.
```

## AQRAX.SPS

Extract from an SPSS batch file which determines the rank queuing position of each 'first-active-wait' on each calendar date, allocating position 1 to the entry with the longest 'time-since-enrolment', and which allows tabulation of the number of 'first-selections' and the number of tied queuing positions on each date at each 'time-since-enrolment'.

GET

FILE='d:\aprax.sav'.

EXECUTE .

SAVE OUTFILE='l:\aqrax.sav' /KEEP=STATUS STRTDT1 STRTDT2 /COMPRESSED.

GET

FILE='l:\aqrax.sav'.

EXECUTE .

IF (XDATE.DATE(strtdt1) <= DATE.DMY(01,07,1994)  
& XDATE.DATE(strtdt2) >= DATE.DMY(01,07,1994)) indicate = 1.

EXECUTE .

IF (XDATE.DATE(strtdt1) <= DATE.DMY(01,07,1994)  
& MISSING(strtdt2) = 1) indicate = 1.

EXECUTE .

USE ALL.

COMPUTE filter\_\$=(ABS(indicate) = 1).

FILTER BY filter\_\$ .

RANK VARIABLES=strtdt1 (A) /RANK INTO h010794 /PRINT=NO /TIES=HIGH.

RANK VARIABLES=strtdt1 (A) /RANK INTO i010794 /PRINT=NO /TIES=LOW.

IF(XDATE.DATE(strtdt2) = DATE.DMY(01,07,1994) & ABS(status) = 1) a010794 = ABS(h010794).

EXECUTE.

FORMATS h010794 (F7).

FORMATS i010794 (F7).

FORMATS a010794 (F7).

SAVE OUTFILE='l:\aqrax.sav' /DROP=indicate filter\_\$ /COMPRESSED.

GET ...

GET ...

GET ...

GET

FILE='l:\aqrax.sav'.

EXECUTE .

IF (XDATE.DATE(strtdt1) <= DATE.DMY(31,12,1994)  
& XDATE.DATE(strtdt2) >= DATE.DMY(31,12,1994)) indicate = 1.

EXECUTE .

IF (XDATE.DATE(strtdt1) <= DATE.DMY(31,12,1994)  
& MISSING(strtdt2) = 1) indicate = 1.

EXECUTE .

USE ALL.

COMPUTE filter\_\$=(ABS(indicate) = 1).

FILTER BY filter\_\$ .

RANK VARIABLES=strtdt1 (A) /RANK INTO h311294 /PRINT=NO /TIES=HIGH.

RANK VARIABLES=strtdt1 (A) /RANK INTO i311294 /PRINT=NO /TIES=LOW.

IF(XDATE.DATE(strtdt2) = DATE.DMY(31,12,1994) & ABS(status) = 1) a311294 = ABS(h311294).

EXECUTE.

FORMATS h311294 (F7).

FORMATS i311294 (F7).

FORMATS a311294 (F7).

SAVE OUTFILE='l:\aqrax.sav' /DROP=indicate filter\_\$ /COMPRESSED.

```

GET
  FILE='l:\aqrax.sav'.
EXECUTE .
AGGREGATE
  /OUTFILE=*
  /BREAK=strtdt1
  /h0107= MEAN(h010794) / . / . /h3112 = MEAN(h311294) /N_BREAK=N.
ADD FILES /FILE=*
  /FILE='l:\dates.sav'.
EXECUTE.
AGGREGATE
  /OUTFILE=*
  /BREAK=strtdt1
  /mh0107= MEAN(h0107) / . / . /mh3112 = MEAN(h3112) /n_break = MAX(n_break) /N=N.
SAVE OUTFILE='l:\aqraxhmn.sav'
  /COMPRESSED.
SAVE TRANSLATE OUTFILE='l:\aqraxhmn.xls'
  /TYPE=XLS /MAP /REPLA /FIELDNAMES.

```

```

GET
  FILE='l:\aqrax.sav'.
EXECUTE .
AGGREGATE
  /OUTFILE=*
  /BREAK=strtdt1
  /i0107 = MEAN(i010794) / . / . /i3112 = MEAN(i311294)
  /N_BREAK=N.
ADD FILES /FILE=*
  /FILE='l:\dates.sav'.
EXECUTE.
AGGREGATE
  /OUTFILE=*
  /BREAK=strtdt1
  /mi0107 = MEAN(i0107) / . / . /mi3112 = MEAN(i3112) /n_break = MAX(n_break) /N=N.
SAVE OUTFILE='l:\aqraxlmn.sav'
  /COMPRESSED.
SAVE TRANSLATE OUTFILE='l:\aqraxlmn.xls'
  /TYPE=XLS /MAP /REPLA /FIELDNAMES.

```

```

GET
  FILE='l:\aqrax.sav'.
EXECUTE .
AGGREGATE
  /OUTFILE=*
  /BREAK=strtdt1
  /a0107 = N(a010794) / . / . /a3112 = N(a311294) /N_BREAK=N.
ADD FILES /FILE=*
  /FILE='l:\dates.sav'.
EXECUTE.
AGGREGATE
  /OUTFILE=*
  /BREAK=strtdt1
  /sa0107 = SUM(a0107) / . / . /sa3112 = SUM(a3112) /n_break= MAX(n_break) /N=N.
SAVE OUTFILE='l:\aqraxsa.sav'
  /COMPRESSED.
SAVE TRANSLATE OUTFILE='l:\aqraxsa.xls'
  /TYPE=XLS /MAP /REPLA /FIELDNAMES.

```

Complete PERIOD lifetable of the cumulative likelihood of  
 'surviving' first-selection' from the Orthopaedic waiting list at  
 Kingston Hospital NHS Trust between 1 July and 31 December  
 1994

Table 7.1: Kaplan-Meier  
 estimate of  $I_x$

Time	N	A	M=A/N	C	$I_x$
0	939	219	0.2332		1.0000
1	726	4	0.0055		0.7668
2	723	4	0.0055		0.7625
3	726	2	0.0028		0.7583
4	734	5	0.0068		0.7562
5	729	5	0.0069		0.7511
6	724	8	0.0110		0.7459
7	720	12	0.0167		0.7377
8	713	7	0.0098		0.7254
9	710	10	0.0141		0.7183
10	701	9	0.0128		0.7082
11	698	7	0.0100		0.6991
12	685	5	0.0073		0.6921
13	668	6	0.0090		0.6870
14	669	10	0.0149		0.6808
15	663	6	0.0090		0.6707
16	648	9	0.0139		0.6646
17	636	4	0.0063		0.6554
18	633	2	0.0032		0.6512
19	628	1	0.0016		0.6492
20	609	3	0.0049		0.6481
21	607	7	0.0115		0.6450
22	605	4	0.0066		0.6375
23	597	4	0.0067		0.6333
24	592	5	0.0084		0.6291
25	599	6	0.0100		0.6237
26	589	4	0.0068		0.6175
27	581	5	0.0086		0.6133
28	586	4	0.0068		0.6080
29	590	7	0.0119		0.6039
30	571	8	0.0140	2	0.5967
31	558	3	0.0054		0.5884
32	552	3	0.0054		0.5852
33	543	0	0.0000		0.5820
34	536	3	0.0056		0.5820
35	534	11	0.0206		0.5787
36	523	2	0.0038		0.5668
37	519	1	0.0019		0.5647
38	510	2	0.0039		0.5636
39	512	1	0.0020		0.5614
40	505	0	0.0000		0.5603

Table 7.2: 'Queuing  
 position' estimate of  $I_x$

Time	QP	A	A/QP	$I_x$
0	939	219	0.2332	1.0000
1	726	4	0.0055	0.7668
2	723	4	0.0055	0.7625
3	726	2	0.0028	0.7583
4	734	5	0.0068	0.7562
5	729	5	0.0069	0.7511
6	724	8	0.0110	0.7459
7	720	12	0.0167	0.7377
8	713	7	0.0098	0.7254
9	710	10	0.0141	0.7183
10	701	9	0.0128	0.7082
11	698	7	0.0100	0.6991
12	685	5	0.0073	0.6921
13	668	6	0.0090	0.6870
14	669	10	0.0149	0.6808
15	663	6	0.0090	0.6707
16	648	9	0.0139	0.6646
17	636	4	0.0063	0.6554
18	633	2	0.0032	0.6512
19	628	1	0.0016	0.6492
20	609	3	0.0049	0.6481
21	607	7	0.0115	0.6450
22	605	4	0.0066	0.6375
23	597	4	0.0067	0.6333
24	592	5	0.0084	0.6291
25	599	6	0.0100	0.6237
26	589	4	0.0068	0.6175
27	581	5	0.0086	0.6133
28	586	4	0.0068	0.6080
29	590	7	0.0119	0.6039
30	571	8	0.0140	0.5967
31	558	3	0.0054	0.5884
32	552	3	0.0054	0.5852
33	543	0	0.0000	0.5820
34	536	3	0.0056	0.5820
35	534	11	0.0206	0.5787
36	523	2	0.0038	0.5668
37	519	1	0.0019	0.5647
38	510	2	0.0039	0.5636
39	512	1	0.0020	0.5614
40	505	0	0.0000	0.5603

39	512	1	0.0020	0.5614	39	512	1	0.0020	0.5614
40	505	0	0.0000	0.5603	40	505	0	0.0000	0.5603
41	499	3	0.0060	0.5603	41	499	3	0.0060	0.5603
42	498	0	0.0000	0.5569	42	498	0	0.0000	0.5569
43	503	3	0.0060	0.5569	43	503	3	0.0060	0.5569
44	496	1	0.0020	0.5536	44	496	1	0.0020	0.5536
45	494	3	0.0061	0.5525	45	494	3	0.0061	0.5525
46	500	2	0.0040	0.5491	46	500	2	0.0040	0.5491
47	493	0	0.0000	0.5469	47	493	0	0.0000	0.5469
48	485	3	0.0062	0.5469	48	485	3	0.0062	0.5469
49	485	4	0.0082	0.5435	49	485	4	0.0082	0.5435
50	484	2	0.0041	0.5390	50	484	2	0.0041	0.5390
51	493	3	0.0061	0.5368	51	493	3	0.0061	0.5368
52	488	2	0.0041	0.5335	52	488	2	0.0041	0.5335
53	493	3	0.0061	0.5314	53	493	3	0.0061	0.5314
54	486	3	0.0062	0.5281	54	486	3	0.0062	0.5281
55	476	1	0.0021	0.5249	55	476	1	0.0021	0.5249
56	479	7	0.0146	0.5238	56	479	7	0.0146	0.5238
57	475	1	0.0021	0.5161	57	475	1	0.0021	0.5161
58	467	0	0.0000	0.5150	58	467	0	0.0000	0.5150
59	467	1	0.0021	0.5150	59	467	1	0.0021	0.5150
60	465	1	0.0022	0.5139	60	465	1	0.0022	0.5139
61	461	1	0.0022	1 0.5128	61	461	1	0.0022	0.5128
62	452	0	0.0000	0.5117	62	452	0	0.0000	0.5117
63	454	3	0.0066	0.5117	63	454	3	0.0066	0.5117
64	454	4	0.0088	0.5083	64	454	4	0.0088	0.5083
65	445	1	0.0022	0.5038	65	445	1	0.0022	0.5038
66	441	3	0.0068	0.5027	66	441	3	0.0068	0.5027
67	439	6	0.0137	0.4993	67	439	6	0.0137	0.4993
68	430	1	0.0023	0.4925	68	430	1	0.0023	0.4925
69	426	2	0.0047	0.4913	69	426	2	0.0047	0.4913
70	429	4	0.0093	0.4890	70	429	4	0.0093	0.4890
71	427	2	0.0047	0.4845	71	427	2	0.0047	0.4845
72	420	5	0.0119	0.4822	72	420	5	0.0119	0.4822
73	406	2	0.0049	0.4764	73	406	2	0.0049	0.4764
74	403	2	0.0050	0.4741	74	403	2	0.0050	0.4741
75	397	0	0.0000	2 0.4717	75	397	0	0.0000	0.4717
76	383	0	0.0000	0.4717	76	383	0	0.0000	0.4717
77	383	6	0.0157	0.4717	77	383	6	0.0157	0.4717
78	379	1	0.0026	1 0.4644	78	379	1	0.0026	0.4644
79	376	0	0.0000	0.4631	79	376	0	0.0000	0.4631
80	373	2	0.0054	0.4631	80	373	2	0.0054	0.4631
81	372	0	0.0000	1 0.4606	81	372	0	0.0000	0.4606
82	368	1	0.0027	0.4606	82	368	1	0.0027	0.4606
83	363	2	0.0055	0.4594	83	363	2	0.0055	0.4594
84	366	3	0.0082	0.4569	84	366	3	0.0082	0.4569
85	366	4	0.0109	0.4531	85	366	4	0.0109	0.4531
86	362	1	0.0028	0.4482	86	362	1	0.0028	0.4482
87	361	4	0.0111	0.4469	87	361	4	0.0111	0.4469
88	350	3	0.0086	0.4420	88	350	3	0.0086	0.4420
89	351	1	0.0028	0.4382	89	351	1	0.0028	0.4382
90	343	2	0.0058	0.4369	90	343	2	0.0058	0.4369

91	341	6	0.0176	0.4344	91	341	6	0.0176	0.4344
92	346	3	0.0087	0.4268	92	346	3	0.0087	0.4268
93	340	0	0.0000	0.4231	93	340	0	0.0000	0.4231
94	338	1	0.0030	0.4231	94	338	1	0.0030	0.4231
95	336	2	0.0060	0.4218	95	336	2	0.0060	0.4218
96	329	0	0.0000	0.4193	96	329	0	0.0000	0.4193
97	326	2	0.0061	0.4193	97	326	2	0.0061	0.4193
98	327	4	0.0122	0.4167	98	327	4	0.0122	0.4167
99	325	0	0.0000	0.4116	99	325	0	0.0000	0.4116
100	325	1	0.0031	0.4116	100	325	1	0.0031	0.4116
101	316	1	0.0032	0.4104	101	316	1	0.0032	0.4104
102	315	2	0.0063	0.4091	102	315	2	0.0063	0.4091
103	312	1	0.0032	0.4065	103	312	1	0.0032	0.4065
104	304	2	0.0066	0.4052	104	304	2	0.0066	0.4052
105	310	0	0.0000	0.4025	105	310	0	0.0000	0.4025
106	312	4	0.0128	0.4025	106	312	4	0.0128	0.4025
107	304	1	0.0033	0.3973	107	304	1	0.0033	0.3973
108	302	2	0.0066	0.3960	108	302	2	0.0066	0.3960
109	306	3	0.0098	0.3934	109	306	3	0.0098	0.3934
110	299	1	0.0033	0.3895	110	299	1	0.0033	0.3895
111	291	1	0.0034	0.3882	111	291	1	0.0034	0.3882
112	295	2	0.0068	0.3869	112	295	2	0.0068	0.3869
113	294	1	0.0034	0.3843	113	294	1	0.0034	0.3843
114	290	2	0.0069	0.3830	114	290	2	0.0069	0.3830
115	289	0	0.0000	0.3803	115	289	0	0.0000	0.3803
116	288	0	0.0000	0.3803	116	288	0	0.0000	0.3803
117	286	1	0.0035	0.3803	117	286	1	0.0035	0.3803
118	279	2	0.0072	0.3790	118	279	2	0.0072	0.3790
119	279	4	0.0143	0.3763	119	279	4	0.0143	0.3763
120	275	2	0.0073	0.3709	120	275	2	0.0073	0.3709
121	271	0	0.0000	0.3682	121	271	0	0.0000	0.3682
122	274	1	0.0036	0.3682	122	274	1	0.0036	0.3682
123	278	1	0.0036	0.3669	123	278	1	0.0036	0.3669
124	277	0	0.0000	0.3655	124	277	0	0.0000	0.3655
125	277	1	0.0036	0.3655	125	277	1	0.0036	0.3655
126	280	0	0.0000	0.3642	126	280	0	0.0000	0.3642
127	284	1	0.0035	0.3642	127	284	1	0.0035	0.3642
128	276	3	0.0109	0.3629	128	276	3	0.0109	0.3629
129	273	2	0.0073	0.3590	129	273	2	0.0073	0.3590
130	273	3	0.0110	0.3564	130	273	3	0.0110	0.3564
131	270	1	0.0037	0.3524	131	270	1	0.0037	0.3524
132	266	1	0.0038	0.3511	132	266	1	0.0038	0.3511
133	270	4	0.0148	0.3498	133	270	4	0.0148	0.3498
134	266	1	0.0038	0.3446	134	266	1	0.0038	0.3446
135	262	3	0.0115	0.3433	135	262	3	0.0115	0.3433
136	258	2	0.0078	0.3394	136	258	2	0.0078	0.3394
137	259	1	0.0039	0.3368	137	259	1	0.0039	0.3368
138	256	1	0.0039	0.3355	138	256	1	0.0039	0.3355
139	246	2	0.0081	0.3342	139	246	2	0.0081	0.3342
140	246	2	0.0081	0.3314	140	246	2	0.0081	0.3314
141	247	2	0.0081	0.3288	141	247	2	0.0081	0.3288
142	243	0	0.0000	0.3261	142	243	0	0.0000	0.3261

143	240	2	0.0083	0.3261	143	240	2	0.0083	0.3261
144	239	0	0.0000	0.3234	144	239	0	0.0000	0.3234
145	237	0	0.0000	0.3234	145	237	0	0.0000	0.3234
146	233	1	0.0043	0.3234	146	233	1	0.0043	0.3234
147	233	1	0.0043	0.3220	147	233	1	0.0043	0.3220
148	233	1	0.0043	0.3206	148	233	1	0.0043	0.3206
149	231	0	0.0000	0.3192	149	231	0	0.0000	0.3192
150	231	0	0.0000	1 0.3192	150	231	0	0.0000	0.3192
151	233	0	0.0000	0.3192	151	233	0	0.0000	0.3192
152	228	1	0.0044	0.3192	152	228	1	0.0044	0.3192
153	227	1	0.0044	0.3178	153	227	1	0.0044	0.3178
154	232	0	0.0000	1 0.3164	154	232	0	0.0000	0.3164
155	232	2	0.0086	0.3164	155	232	2	0.0086	0.3164
156	227	0	0.0000	0.3137	156	227	0	0.0000	0.3137
157	228	2	0.0088	0.3137	157	228	2	0.0088	0.3137
158	230	0	0.0000	0.3109	158	230	0	0.0000	0.3109
159	230	0	0.0000	0.3109	159	230	0	0.0000	0.3109
160	227	1	0.0044	1 0.3109	160	227	1	0.0044	0.3109
161	225	1	0.0044	0.3096	161	225	1	0.0044	0.3096
162	227	1	0.0044	0.3082	162	227	1	0.0044	0.3082
163	226	1	0.0044	0.3068	163	226	1	0.0044	0.3068
164	221	1	0.0045	1 0.3055	164	221	1	0.0045	0.3055
165	223	2	0.0090	0.3041	165	223	2	0.0090	0.3041
166	219	4	0.0183	0.3014	166	219	4	0.0183	0.3014
167	209	0	0.0000	0.2959	167	209	0	0.0000	0.2959
168	212	1	0.0047	0.2959	168	212	1	0.0047	0.2959
169	212	3	0.0142	0.2945	169	212	3	0.0142	0.2945
170	206	4	0.0194	0.2903	170	206	4	0.0194	0.2903
171	201	2	0.0100	0.2847	171	201	2	0.0100	0.2847
172	201	1	0.0050	0.2818	172	201	1	0.0050	0.2818
173	198	3	0.0152	0.2804	173	198	3	0.0152	0.2804
174	190	1	0.0053	0.2762	174	190	1	0.0053	0.2762
175	191	2	0.0105	0.2747	175	191	2	0.0105	0.2747
176	190	4	0.0211	0.2719	176	190	4	0.0211	0.2719
177	188	1	0.0053	0.2661	177	188	1	0.0053	0.2661
178	186	1	0.0054	0.2647	178	186	1	0.0054	0.2647
179	184	1	0.0054	0.2633	179	184	1	0.0054	0.2633
180	183	0	0.0000	0.2619	180	183	0	0.0000	0.2619
181	178	1	0.0056	0.2619	181	178	1	0.0056	0.2619
182	177	1	0.0056	0.2604	182	177	1	0.0056	0.2604
183	176	0	0.0000	0.2589	183	176	0	0.0000	0.2589
184	174	1	0.0057	0.2589	184	174	1	0.0057	0.2589
185	172	1	0.0058	0.2574	185	172	1	0.0058	0.2574
186	170	0	0.0000	0.2559	186	170	0	0.0000	0.2559
187	170	0	0.0000	0.2559	187	170	0	0.0000	0.2559
188	168	0	0.0000	0.2559	188	168	0	0.0000	0.2559
189	168	0	0.0000	0.2559	189	168	0	0.0000	0.2559
190	168	0	0.0000	0.2559	190	168	0	0.0000	0.2559
191	166	3	0.0181	0.2559	191	166	3	0.0181	0.2559
192	162	0	0.0000	0.2513	192	162	0	0.0000	0.2513
193	163	1	0.0061	0.2513	193	163	1	0.0061	0.2513
194	161	0	0.0000	0.2498	194	161	0	0.0000	0.2498



195	160	2	0.0125	0.2498	195	160	2	0.0125	0.2498
196	158	1	0.0063	0.2466	196	158	1	0.0063	0.2466
197	157	1	0.0064	0.2451	197	157	1	0.0064	0.2451
198	156	0	0.0000	0.2435	198	156	0	0.0000	0.2435
199	157	1	0.0064	0.2435	199	157	1	0.0064	0.2435
200	159	0	0.0000	0.2420	200	159	0	0.0000	0.2420
201	159	0	0.0000	0.2420	201	159	0	0.0000	0.2420
202	158	0	0.0000	1 0.2420	202	158	0	0.0000	0.2420
203	157	3	0.0191	0.2420	203	157	3	0.0191	0.2420
204	155	0	0.0000	0.2374	204	155	0	0.0000	0.2374
205	154	1	0.0065	0.2374	205	154	1	0.0065	0.2374
206	158	2	0.0127	0.2358	206	158	2	0.0127	0.2358
207	158	0	0.0000	0.2328	207	158	0	0.0000	0.2328
208	158	1	0.0063	0.2328	208	158	1	0.0063	0.2328
209	155	2	0.0129	0.2314	209	155	2	0.0129	0.2314
210	153	3	0.0196	0.2284	210	153	3	0.0196	0.2284
211	152	1	0.0066	0.2239	211	152	1	0.0066	0.2239
212	150	1	0.0067	0.2224	212	150	1	0.0067	0.2224
213	148	1	0.0068	0.2209	213	148	1	0.0068	0.2209
214	152	2	0.0132	0.2194	214	152	2	0.0132	0.2194
215	150	0	0.0000	0.2166	215	150	0	0.0000	0.2166
216	150	2	0.0133	0.2166	216	150	2	0.0133	0.2166
217	148	0	0.0000	1 0.2137	217	148	0	0.0000	0.2137
218	148	2	0.0135	0.2137	218	148	2	0.0135	0.2137
219	146	0	0.0000	1 0.2108	219	146	0	0.0000	0.2108
220	147	1	0.0068	1 0.2108	220	147	1	0.0068	0.2108
221	150	1	0.0067	1 0.2093	221	150	1	0.0067	0.2093
222	148	0	0.0000	0.2079	222	148	0	0.0000	0.2079
223	145	2	0.0138	0.2079	223	145	2	0.0138	0.2079
224	150	4	0.0267	0.2051	224	150	4	0.0267	0.2051
225	146	0	0.0000	0.1996	225	146	0	0.0000	0.1996
226	144	1	0.0069	0.1996	226	144	1	0.0069	0.1996
227	142	1	0.0070	2 0.1982	227	142	1	0.0070	0.1982
228	141	3	0.0213	0.1968	228	141	3	0.0213	0.1968
229	138	1	0.0072	0.1926	229	138	1	0.0072	0.1926
230	135	3	0.0222	0.1912	230	135	3	0.0222	0.1912
231	132	8	0.0606	0.1870	231	132	8	0.0606	0.1870
232	124	1	0.0081	0.1757	232	124	1	0.0081	0.1757
233	122	1	0.0082	0.1742	233	122	1	0.0082	0.1742
234	123	6	0.0488	1 0.1728	234	123	6	0.0488	0.1728
235	112	0	0.0000	0.1644	235	112	0	0.0000	0.1644
236	111	2	0.0180	0.1644	236	111	2	0.0180	0.1644
237	107	3	0.0280	0.1614	237	107	3	0.0280	0.1614
238	105	2	0.0190	1 0.1569	238	105	2	0.0190	0.1569
239	102	2	0.0196	0.1539	239	102	2	0.0196	0.1539
240	98	0	0.0000	0.1509	240	98	0	0.0000	0.1509
241	99	1	0.0101	0.1509	241	99	1	0.0101	0.1509
242	100	0	0.0000	0.1494	242	100	0	0.0000	0.1494
243	100	0	0.0000	0.1494	243	100	0	0.0000	0.1494
244	100	0	0.0000	0.1494	244	100	0	0.0000	0.1494
245	100	0	0.0000	0.1494	245	100	0	0.0000	0.1494
246	100	1	0.0100	0.1494	246	100	1	0.0100	0.1494

247	99	1	0.0101	0.1479	247	99	1	0.0101	0.1479
248	98	0	0.0000	0.1464	248	98	0	0.0000	0.1464
249	99	2	0.0202	0.1464	249	99	2	0.0202	0.1464
250	97	0	0.0000	0.1434	250	97	0	0.0000	0.1434
251	95	1	0.0105	0.1434	251	95	1	0.0105	0.1434
252	97	0	0.0000	0.1419	252	97	0	0.0000	0.1419
253	98	1	0.0102	1 0.1419	253	98	1	0.0102	0.1419
254	93	1	0.0108	0.1405	254	93	1	0.0108	0.1405
255	95	0	0.0000	0.1390	255	95	0	0.0000	0.1390
256	96	0	0.0000	0.1390	256	96	0	0.0000	0.1390
257	95	1	0.0105	1 0.1390	257	95	1	0.0105	0.1390
258	91	2	0.0220	0.1375	258	91	2	0.0220	0.1375
259	90	1	0.0111	0.1345	259	90	1	0.0111	0.1345
260	90	0	0.0000	0.1330	260	90	0	0.0000	0.1330
261	90	3	0.0333	0.1330	261	90	3	0.0333	0.1330
262	91	2	0.0220	1 0.1285	262	91	2	0.0220	0.1285
263	91	3	0.0330	0.1257	263	91	3	0.0330	0.1257
264	88	1	0.0114	0.1216	264	88	1	0.0114	0.1216
265	87	1	0.0115	0.1202	265	87	1	0.0115	0.1202
266	86	5	0.0581	0.1188	266	86	5	0.0581	0.1188
267	81	0	0.0000	0.1119	267	81	0	0.0000	0.1119
268	81	1	0.0123	0.1119	268	81	1	0.0123	0.1119
269	80	3	0.0375	1 0.1105	269	80	3	0.0375	0.1105
270	75	2	0.0267	0.1064	270	75	2	0.0267	0.1064
271	73	2	0.0274	0.1035	271	73	2	0.0274	0.1035
272	71	1	0.0141	0.1007	272	71	1	0.0141	0.1007
273	70	2	0.0286	0.0993	273	70	2	0.0286	0.0993
274	68	0	0.0000	0.0964	274	68	0	0.0000	0.0964
275	68	3	0.0441	0.0964	275	68	3	0.0441	0.0964
276	64	1	0.0156	0.0922	276	64	1	0.0156	0.0922
277	63	4	0.0635	0.0908	277	63	4	0.0635	0.0908
278	58	0	0.0000	0.0850	278	58	0	0.0000	0.0850
279	58	2	0.0345	0.0850	279	58	2	0.0345	0.0850
280	58	2	0.0345	0.0821	280	58	2	0.0345	0.0821
281	56	0	0.0000	0.0792	281	56	0	0.0000	0.0792
282	56	0	0.0000	0.0792	282	56	0	0.0000	0.0792
283	56	0	0.0000	0.0792	283	56	0	0.0000	0.0792
284	57	5	0.0877	0.0792	284	57	5	0.0877	0.0792
285	52	0	0.0000	0.0723	285	52	0	0.0000	0.0723
286	52	0	0.0000	0.0723	286	52	0	0.0000	0.0723
287	52	2	0.0385	1 0.0723	287	52	2	0.0385	0.0723
288	49	0	0.0000	0.0695	288	49	0	0.0000	0.0695
289	49	2	0.0408	0.0695	289	49	2	0.0408	0.0695
290	47	2	0.0426	0.0667	290	47	2	0.0426	0.0667
291	44	3	0.0682	0.0638	291	44	3	0.0682	0.0638
292	41	0	0.0000	0.0595	292	41	0	0.0000	0.0595
293	40	1	0.0250	0.0595	293	40	1	0.0250	0.0595
294	39	5	0.1282	0.0580	294	39	5	0.1282	0.0580
295	35	0	0.0000	1 0.0506	295	35	0	0.0000	0.0506
296	33	1	0.0303	0.0506	296	33	1	0.0303	0.0506
297	33	1	0.0303	0.0490	297	33	1	0.0303	0.0490
298	32	0	0.0000	0.0475	298	32	0	0.0000	0.0475

299	32	0	0.0000	0.0475	299	32	0	0.0000	0.0475
300	30	0	0.0000	0.0475	300	30	0	0.0000	0.0475
301	30	1	0.0333	0.0475	301	30	1	0.0333	0.0475
302	29	0	0.0000	0.0460	302	29	0	0.0000	0.0460
303	28	1	0.0357	0.0460	303	28	1	0.0357	0.0460
304	28	1	0.0357	0.0443	304	28	1	0.0357	0.0443
305	27	0	0.0000	0.0427	305	27	0	0.0000	0.0427
306	27	0	0.0000	0.0427	306	27	0	0.0000	0.0427
307	27	2	0.0741	1 0.0427	307	27	2	0.0741	0.0427
308	25	1	0.0400	1 0.0396	308	25	1	0.0400	0.0396
309	23	1	0.0435	0.0380	309	23	1	0.0435	0.0380
310	21	1	0.0476	0.0363	310	21	1	0.0476	0.0363
311	21	0	0.0000	0.0346	311	21	0	0.0000	0.0346
312	21	1	0.0476	0.0346	312	21	1	0.0476	0.0346
313	20	1	0.0500	0.0330	313	20	1	0.0500	0.0330
314	19	1	0.0526	0.0313	314	19	1	0.0526	0.0313
315	18	1	0.0556	0.0297	315	18	1	0.0556	0.0297
316	17	0	0.0000	0.0280	316	17	0	0.0000	0.0280
317	17	2	0.1176	0.0280	317	17	2	0.1176	0.0280
318	15	1	0.0667	1 0.0247	318	15	1	0.0667	0.0247
319	14	1	0.0714	0.0231	319	14	1	0.0714	0.0231
320	13	0	0.0000	0.0214	320	13	0	0.0000	0.0214
321	13	1	0.0769	0.0214	321	13	1	0.0769	0.0214
322	13	0	0.0000	1 0.0198	322	13	0	0.0000	0.0198
323	12	1	0.0833	0.0198	323	12	1	0.0833	0.0198
324	11	0	0.0000	0.0181	324	11	0	0.0000	0.0181
325	13	1	0.0769	0.0181	325	13	1	0.0769	0.0181
326	12	0	0.0000	0.0167	326	12	0	0.0000	0.0167
327	12	0	0.0000	0.0167	327	12	0	0.0000	0.0167
328	12	0	0.0000	0.0167	328	12	0	0.0000	0.0167
329	12	0	0.0000	1 0.0167	329	12	0	0.0000	0.0167
330	11	1	0.0909	0.0167	330	11	1	0.0909	0.0167
331	10	1	0.1000	0.0152	331	10	1	0.1000	0.0152
332	10	0	0.0000	0.0137	332	10	0	0.0000	0.0137
333	10	0	0.0000	0.0137	333	10	0	0.0000	0.0137
334	10	1	0.1000	1 0.0137	334	10	1	0.1000	0.0137
335	8	0	0.0000	0.0123	335	8	0	0.0000	0.0123
336	8	1	0.1250	0.0123	336	8	1	0.1250	0.0123
337	7	0	0.0000	0.0108	337	7	0	0.0000	0.0108
338	6	0	0.0000	0.0108	338	6	0	0.0000	0.0108
339	6	0	0.0000	0.0108	339	6	0	0.0000	0.0108
340	6	0	0.0000	0.0108	340	6	0	0.0000	0.0108
341	6	1	0.1667	0.0108	341	6	1	0.1667	0.0108
342	5	0	0.0000	0.0090	342	5	0	0.0000	0.0090
343	5	0	0.0000	0.0090	343	5	0	0.0000	0.0090
344	5	0	0.0000	0.0090	344	5	0	0.0000	0.0090
345	5	0	0.0000	0.0090	345	5	0	0.0000	0.0090
346	5	0	0.0000	0.0090	346	5	0	0.0000	0.0090
347	5	0	0.0000	0.0090	347	5	0	0.0000	0.0090
348	5	0	0.0000	0.0090	348	5	0	0.0000	0.0090
349	5	0	0.0000	0.0090	349	5	0	0.0000	0.0090
350	5	0	0.0000	0.0090	350	5	0	0.0000	0.0090

351	5	0	0.0000	0.0090	351	5	0	0.0000	0.0090
352	5	0	0.0000	0.0090	352	5	0	0.0000	0.0090
353	5	0	0.0000	0.0090	353	5	0	0.0000	0.0090
354	5	0	0.0000	0.0090	354	5	0	0.0000	0.0090
355	5	2	0.4000	0.0090	355	5	2	0.4000	0.0090
356	3	0	0.0000	0.0054	356	3	0	0.0000	0.0054
357	3	0	0.0000	0.0054	357	3	0	0.0000	0.0054
358	3	0	0.0000	0.0054	358	3	0	0.0000	0.0054
359	3	0	0.0000	0.0054	359	3	0	0.0000	0.0054
360	3	0	0.0000	0.0054	360	3	0	0.0000	0.0054
361	3	0	0.0000	0.0054	361	3	0	0.0000	0.0054
362	3	1	0.3333	0.0054	362	3	1	0.3333	0.0054
363	2	1	0.5000	0.0036	363	2	1	0.5000	0.0036
364	1	0	0.0000	0.0018	364	1	0	0.0000	0.0018
365	1	0	0.0000	0.0018	365	1	0	0.0000	0.0018
366	1	0	0.0000	0.0018	366	1	0	0.0000	0.0018
367	1	0	0.0000	0.0018	367	1	0	0.0000	0.0018
368	1	0	0.0000	0.0018	368	1	0	0.0000	0.0018
369	1	0	0.0000	0.0018	369	1	0	0.0000	0.0018
370	1	0	0.0000	0.0018	370	1	0	0.0000	0.0018
371	1	1	1.0000	0.0018	371	1	1	1.0000	0.0018

Table 7.3a: Converting a tabulation by date of enrolment to a tabulation by 'time-since-enrolment'

STRTDT1	MH010	MH020	MH030	MH040	MH050	MH060	MH070	MH080	MH090	MH100	MH110	MH120	MH130	MH140	MH150	MH160	MH170	MH180	MH190	MH200	MH210	MH220	MH230	MH2407		
																							444	437	437	
																						445	438	431	431	
																					433	432	428	421	421	
																					444	430	430	426	419	419
																		435	433	426	426	422	415	415		
01-Jul-1994	459	459	459	458	458	455	454	447	446	446	439	406	405	385	383	381	381	381	379	373	373	369	363	363	363	
30-Jun-1994	452	452	452	451	451	449	448	441	440	440	433	400	399	379	377	375	375	375	373	367	367	363	357	357	357	
29-Jun-1994	446	446	446	445	445	443	443	436	435	435	428	396	395	375	373	371	371	371	369	363	363	359	353	353	353	
28-Jun-1994	445	445	445	444	444	442	442	435	434	434	427	395	394	374	372	370	370	370	368	362	362	358	352	352	352	
27-Jun-1994	438	438	438	437	437	435	435	428	427	427	421	389	388	368	366	364	364	364	362	357	357	353	347	347	347	
26-Jun-1994																										
25-Jun-1994																										
24-Jun-1994	427	427	427	426	426	424	424	418	417	417	411	380	379	360	358	356	356	356	354	349	349	345	339	339	339	
23-Jun-1994	423	423	423	422	422	420	420	414	413	413	407	376	375	356	354	352	352	352	350	345	345	341	335	335	335	
22-Jun-1994	418	418	418	417	417	415	415	409	408	408	402	371	370	351	349	347	347	347	345	341	341	337	331	331	331	
21-Jun-1994	414	414	414	413	413	411	411	405	404	404	398	367	366	347	345	343	343	343	341	337	337	333	328	328	328	
20-Jun-1994	410	410	410	409	409	407	407	401	400	400	394	364	363	344	342	340	340	340	338	334	334	330	325	325	325	
19-Jun-1994	402	402	402	401	401	399	399	393	392	392	386	356	355	336	334	332	332	332	330	326	326	322	317	317	317	
18-Jun-1994																										
17-Jun-1994	400	400	400	399	399	397	397	391	390	390	384	354	353	334	332	330	330	330	328	324	324	320	315	315	315	
16-Jun-1994	393	393	393	392	392	390	390	384	383	383	377	347	346	327	325	323	323	323	321	317	317	314	310	310	310	
15-Jun-1994	389	389	389	388	388	386	386	380	379	379	373	343	342	323	321	319	319	319	317	313	313	310	306	306	306	
14-Jun-1994	387	387	387	386	386	384	384	378	377	377	371	341	340	321	319	317	317	317	315	311	311	308	304	304	304	
13-Jun-1994	385	385	385	384	384	382	382	376	375	375	369	339	338	319	317	315	315	315	313	309	309	306	302	302	302	
12-Jun-1994																										
11-Jun-1994																										
10-Jun-1994	383	383	383	382	382	380	380	374	373	373	367	337	336	317	315	313	313	313	311	307	307	304	300	300	300	

Table 7.3b: Converting a tabulation by date of enrolment to a tabulation by 'time-since-enrolment'

Time	MH010	MH020	MH030	MH040	MH050	MH060	MH070	MH080	MH090	MH100	MH110	MH120	MH130	MH140	MH150	MH160	MH170	MH180	MH190	MH200	MH210	MH220	MH230	MH240
0	459			467	474	467	471				471	439	442	427	426			435	444	433	445	444		
1	452	459			466	465	466	464								422			433	430	432	438	437	
2	446	452	459			463	464	459				435	438	418	419				426	426	430	428	431	437
3	445	446	452	458			462	457	458	463			434	416	416	417	422					426	421	431
4	438	445	446	451	458			455	456	458	456				412	414	417	420			426	426	419	421
5		438	445	445	451	455			454	456	451	423				408	412	414	415	413			415	419
6			438	444	445	449	454			454	449	418	422				408	412	412	408	413			415
7	427			437	444	443	448	447			447	416	417	400				408	410	405	408	409		
8	423	427			437	442	443	441	446			414	415	395	398				406	403	405	404	402	
9	418	423	427			435	442	436	440	446			413	393	393	396				399	403	401	397	402
10	414	418	423	426			435	435	435	440	439			391	391	391	396				399	399	394	397
11	410	414	418	422	426			428	434	435	433	406			389	389	391	396				395	392	394
12	402	410	414	417	422	424			427	434	428	400	405			387	389	391	394				388	392
13		402	410	413	417	420	424			427	427	396	399	385			387	389	389	387				388
14	400		402	409	413	415	420	418			421	395	395	379	383			387	387	382	387			
15	393	400		401	409	411	415	414	417			389	394	375	377	381			385	380	382	383		
16	389	393	400		401	407	411	409	413	417			388	374	373	375	381			379	380	378	376	
17	387	389	393	399		399	407	405	408	413	411			368	372	371	375	381			379	376	371	376
18	385	387	389	392	399		399	401	404	408	407	380			366	370	371	375	379			375	370	371
19		385	387	388	392	397		393	400	404	402	376	379			364	370	371	373	373			369	370
20			385	386	388	390			392	400	398	371	375	360			364	370	369	367	373			369
21	383			384	386	386	390	391		392	394	367	370	356	358			364	368	363	367	369		
22	382	383			384	384	386	384	390		386	364	366	351	354	356			362	362	363	363	363	363
23	376	382	383		382	384	380	383	390			356	363	347	349	352	356			357	362	359	357	363
24		376	382	382			382	378	379	383	384		355	344	345	347	352	356			357	358	353	357
25	374		376	381	382			376	377	379	377	354		336	342	343	347	352	354			353	352	353
26	361	374		375	381	380			375	377	373	347	353		334	340	343	347	350	349			347	352
27		361	374		375	379	380			375	371	343	346	334		332	340	343	345	345	349			347
28	360		361	373	373	379	374				369	341	342	327	332		332	340	341	341	345	345		
29	350	360		360	373		373	373	373			339	340	323	325	330		332	338	337	341	341	339	
30		350	360		360	371	367		372	373			338	321	321	323	330		330	334	337	337	335	339
31	342		350	359		359	371		366	372	367			319	319	319	323	330		326	334	333	331	335
32		342		349	359		359	365		366	366	337			317	317	319	323	328		326	330	328	331
33			342		349	358		353	364		360	336	336			315	317	319	321	324		322	325	328
34				341	348	358			352	364		330	335	317			315	317	317	317	324		317	325
35	338				341	348		352		352	358		329	316	315		315	315	315	313	317	320		317
36		338			340		342		351		346	328		311	314	313			313	311	313	314	315	
37	337		338				340		341	351		319	327		309	312	313			309	311	310	310	315
38		337		337				334		341	345		318	309		307	312	313			309	308	306	310
39	335		337		337				333		335	318		300	307	307		312	311			306	304	306
40		335		336		336				333		308		317	298	305		307	310	307			302	304
41			335		336		336				327		307	299		296	305		305	306	307			302
42	331			334	335			330				300		289	297		296	305	301	306	304			
43	329	331			334	335			329				299		287	295		296	303	301	303		300	
44	324	329	331			333	329			329				281		285	295		294	299		298	299	300