

**HEALTH CARE IN CONTEXT, POLICY INTO
PRACTICE:
A POLICY ANALYSIS OF INTEGRATING
STD/HIV AND MCH/FP SERVICES IN GHANA**

SUSANNAH HARDING MAYHEW

**Thesis submitted to the Faculty of Science of the University of London
for the degree of Doctor of Philosophy**

**London School of Hygiene and Tropical Medicine
Department of Public Health and Policy
November 1998**

I

Abstract

This research is one contribution to understanding the nature of policy and of power, the interaction of the state and its machinery with individuals at all levels, the tensions between public and private choices and responsibilities, between public health and clinical health care.

Adapting a policy analysis approach, this thesis provides a case study of the development and implementation of reproductive health policies in Ghana. The aim is to enhance understanding of why there are differences between policy and practice and what the potentials are for integrating STD/HIV management into MCH/FP services in Ghana to improve reproductive health.

This thesis argues that all elements of policy and policy analysis are located within a 'contextual framework' and are influenced by a range of contextual factors (defined and illustrated through the thesis) which are seldom taken into account in policy process and analysis. It is argued that understanding the different levels of context is fundamental to understanding the processes of policy development and implementation, the actions of actors at all levels and the policy outcomes.

Using a multi-level focus and a combination of approaches, this thesis identifies the contextual factors and their manifestations at each level of the policy process and illustrates *how* they impact on policy. The analysis synthesises macro and micro dimensions gaining a more comprehensive understanding of the influences on and gaps between policy development and implementation.

At the implementation level, 27 clinics were visited and 94 clinic staff interviewed in one rural region of Ghana, to ascertain what STD/HIV management services are actually being provided and what factors influence service provision (policy implementation). Interviews with community leaders and focus groups with villagers were conducted in the same region to explore community perspectives of disease and health care services and understand the factors influencing service utilisation (policy outcome). The role of the regional health administration as an intermediary was considered and understanding sought of the concepts of power which influence administrative and management structures. The national level interviews with government and Ministry of Health officials and with donor, NGO and national group representatives, provide further insight into the concepts of power and status

and who influences policy making. Finally, all elements are brought together and discussed, a reworked framework is presented and suggestions for future policy and research directions are made.

II Acknowledgements

I am indebted to a great many people who have given invaluable support and guidance, in the UK and in Ghana. Inevitably they cannot all be mentioned and their contributions are many and varied.

In London, thanks must go first to my supervisor, Dr. Gill Walt, without whom this particular research might never have taken place. Her optimism in my abilities and her constant support and inspiration has made my research experience a positive one in which the down-turns of the proverbial wheel never lasted too long.

Also, to my advisory committee: Dr John Cleland, Dr Jessica Ogden and David Ross. Each, at various points throughout the process, gave helpful and encouraging advice and observations. Numerous other friends and colleagues (on various continents) gave motivation, comments and offers of late night beer - all much appreciated! Special thanks to Michael for various technical and organisational assistance and to Zsuzsa for helping me to play around with triangles.

Special acknowledgement is due to the Economic and Social Research Council (ESRC) who sponsored this venture. Without their assistance, I would not be doing this at all.

My deepest affection goes to my family who, as always, bore the brunt of my rants and saw me through the highs and lows with understanding and love providing a haven to which I could escape and simply 'be'. Lucy and Katharine proved the best field research assistants, tuning quickly into my wave-length and providing essential sounding-boards for my disparate thoughts - from community health nurses to Plato...

I am perhaps most indebted to the people of Ghana.

Dr Sam Adjei in the Health Research Unit of the Ministry of Health provided me with essential introductions, a permanent 'base' and invaluable advice. For his time and friendly concern I am most grateful. Tremendous intellectual support was given too by the researchers of the Navrongo Health Research Centre in the Upper East, particularly Dr Nazzar, who made their documents and thoughts available to me.

Mrs 'Auntie' Assiedu provided a welcome home in Accra and her 'institute' was the venue for many enlightening and thought-provoking discussions on Ghana and Ghanaians. In the Upper East, the Ayeebos gave me a second home, welcoming me as part of their family in Yelwoko, both in 1995 and during my fleeting visits throughout 1996-7. Similarly in Bolgatanga the people of the Anglican mission opened their compound to me. Thanks to the hard work of Azumah and Bebe I was left free to use my computer in the evenings - at least until the children came to ask if they could watch my 'television'.

At the regional Health Administration of the Upper East, sincere thanks go to Dr Amankuah who promptly issued me with the necessary introductions and most generously gave me the use of the Ministry vehicles and drivers (gratitude particularly to Mustapha) without whose local knowledge we would never have found the bush tracks to many of our sampled clinics.

Most of all, a heartfelt thanks to all the health staff at the clinics in the Upper East who gave their time to speak to us and who work with compassion against the odds.

This thesis is dedicated to the memory of Sam, and others like him, through whom I learned much of the harsher side of the health service delivery system; and to the people of the Upper East who, despite their struggle for life and health, *give* so much.

Table of Contents

Abstract	ii
Acknowledgements	iv
Table of Contents.....	vi
List of Appendices.....	xi
List of Tables.....	xii
List of Figures.....	xiii
Acronyms.....	xv
Chapter 1 Integrating STD/HIV and MCH/FP Services:	
What, where, why and how?.....	1
1.1 Introduction: Why integrate reproductive health services?.....	1
1.2 Orientation and Scope of the Study:	5
Justification for a policy analysis approach.....	7
1.3 Conceptual Framework and Terms of Reference.....	8
1.3.1 The policy analysis approach.....	9
1.3.2 Context: the crucial concern.....	10
1.3.3 Defining ‘reproductive health’ and ‘integration’	11
1.3.4 Power and policy: concepts and caveats.....	12
1.4 Aim and Objectives.....	12
1.4.1 Aim.....	12
1.4.2 Objectives.....	13
1.5 Methods.....	14
1.5.1 The case study approach.....	14
1.5.2 Ghana as a case study.....	15
1.5.3 Research tools.....	17
Introduction.....	17
Political mapping and stakeholder analysis.....	18
Document analysis.....	19
Key informant interviews.....	20
Semi-structured interviews.....	20
Situation analysis/structured observation at facilities.....	21
media analysis.....	21
1.5.4 Bias and validation techniques.....	22
1.5.5 Multi-level research.....	22
Sub-district.....	23
District.....	24
Region.....	25
National.....	26
1.6 Thesis Outline.....	27
Chapter 2 Reviewing the Terrain: International Reproductive Health Ideologies	
 and the Ghanaian context.....	29
2.1 Introduction.....	29

2.2 International Debates: vertical vs. horizontal - where do FP/MCH and STD/HIV programmes fit?.....	29
2.3 Realities of Integration: key issues of concern.....	32
2.3.1 Technical, programmatic issues.....	33
Costs and funding.....	33
Organisation and management.....	36
Resources, remits and workloads.....	38
2.3.2 Clinical issues.....	38
Clinical management and the syndromic approach.....	38
Contraceptive choice.....	40
2.3.3 Provider issues.....	41
Treatment focus.....	41
Stigmatisation and wider population.....	42
2.4 The Ghanaian context.....	44
2.4.1 Development and current status of STD/FP services.....	45
Family planning.....	45
STDs.....	47
2.5 Limitations in current literature and research and the importance of this study.....	53
2.5.1 The lack of case studies.....	53
2.5.2 Lack of clarity over definitions of ‘integrated reproductive health’.....	54
2.5.3 Research limitations and the importance of this research.....	56
Chapter 3 The Reality of STD management within MCH/FP: The Upper East.....	59
3.1 A Portrait of the Upper East Region.....	59
3.1.1 Realities of place: The Upper East, its districts and health profile.....	59
3.1.2 Health facilities and technical capacities.....	63
3.2 Policies and Practices: The reality of implementation.....	68
3.2.1 Clinical diagnosis.....	69
Training deficits, staff knowledge and resource controls.....	71
3.2.2 Syndromic management.....	72
STD training and dissemination of guidelines.....	72
3.2.3 Routine Syphilis screening and vaginal examinations.....	74
3.2.4 Routine screening for neo-natal ophthalmia.....	78
3.2.5 Verbal screening.....	78
3.2.6 HIV Screening, counselling and management of AIDS.....	79
3.2.7 Reagents, laboratory testing, surveillance and blood screening.....	80
3.3 Clinical Management Practices: referrals, hierarchies and drug availability.....	82
3.3.1 Referrals, practice-hierarchies and devolution of authority....	82
3.3.2 Drug availability, drug treatment preferences and costs.....	85
3.3.3 Summary of clinical STD management practices within MCH/FP.....	89
3.4 Health Information, Education and Advocacy.....	90
3.4.1 Facility based information/education, counselling and provider-client interactions.....	92
3.4.2 Community information and education.....	95
3.4.3 Reaching men and teenagers.....	97
3.4.4 Condom advocacy and cultural acceptability.....	99
3.4.5 Partner tracing.....	101
3.4.6 Summary.....	102

	3.5 Summary.....	103
Chapter 4	Community Contexts: Experiencing Health Services.....	105
	4.1 Bawku-West: A Rural Archetype.....	106
	4.1.1 Living environments and health profile: the context of life experiences.....	107
	4.1.2 Actors in the sub-district.....	110
	4.2 Health Services Available.....	113
	4.2.1 Binaba health centre.....	113
	4.2.2 Outreach, health education and alternative health care.....	118
	4.3 Service Delivery and Utilisation: social complexities.....	121
	4.3.1 Concepts of hierarchy and the culture of status.....	121
	4.3.2 Familial and social obligations: an economy of affection...	122
	4.3.3 Issues of infrastructure and non-residency.....	123
	4.3.4 Absentee-ism and Activity paralysis.....	124
	4.4 Summary.....	125
Chapter 5	Community Contexts: Community Attitudes and Beliefs.....	127
	5.1 Disease Priorities and Sexual Health.....	128
	5.1.1 Disease priorities: fundamentals of health.....	128
	5.1.2 Perceptions of sexual diseases and reproductive health.....	130
	Perceptions of AIDS.....	132
	Perceptions of STDs.....	134
	5.2 Social/cultural Sexual and Reproductive ‘norms’.....	137
	5.2.1 Attitudes towards sex and reproductive health.....	137
	Reproductive decision making and sexual violence.....	137
	Pronatalist attitudes and the essence of womanhood.....	139
	5.2.2 Sexual and reproductive behaviour ‘norms’.....	141
	Sexual networking and cultural practices: precedents for infection.....	141
	Family planning and condoms: community perspectives.....	142
	5.2.3 Traditional vs. western medical belief systems.....	145
	5.3 Summary.....	147
Chapter 6	Regional Administrations: Ambiguities and Uncertainties.....	149
	6.1 The Decentralisation Context.....	149
	6.2 Regional Health Actors: Organisation, links and network.....	151
	6.2.1 Linkage and networking opportunities.....	151
	6.3 Funding Mechanisms: ‘No money, no friend’.....	154
	6.3.1 Funding sources, controls and regional revenue capacities...	155
	6.3.2 Timeliness of funding.....	158
	6.3.3 Flexibility of finances and priority funding.....	159
	6.4 Supply Flows: Contraceptives, drugs and reagents.....	160
	6.4.1 Supply flows: donor inputs.....	161
	6.4.2 Drugs storage and transportation.....	163
	6.4.3 Pharmacy capacities.....	163
	6.5 Data Management, Surveillance Capacities and Priority Setting.....	165
	6.5.1 Reporting and data collection - vertical structures and management inefficiencies.....	165
	6.5.2 STD surveillance capacities and data collection.....	167
	6.6 Training and Follow-Up.....	169
	6.6.1 Some caveats regarding training.....	169

6.6.2	Current STD training: national curricula and regional activities.....	170
6.6.3	Development of training manuals and participant selection..	171
6.6.4	Streamlining and follow-up.....	173
6.7	Treatment Mandates, Health Education and Wider Networks.....	174
6.7.1	Treatment hierarchies.....	174
6.7.2	Health Education.....	174
	Health education: low priority and crisis orientated.....	175
6.7.3	Wider networking potentials.....	175
6.8	Summary.....	176
Chapter 7	National Stage, Multiple Voices.....	178
7.1	Policy Development and Programme Structures.....	178
7.1.1	The rise of Ghana's reproductive health policy vision.....	179
7.1.2	The National Council on Population - inhibited potential?....	182
	Family Planning in Ghana.....	182
7.1.3	MCH/FP and STD/HIV programmes.....	185
	Ministry programme structures and vertical organisation.....	185
	Donor influence and MoH response: exacerbating the splits.....	190
	AIDS vs. STDs.....	192
	Population, family planning and MCH.....	193
	Summary.....	195
7.2	The Wider Arena.....	195
7.2.1	Regional representatives: a cry in the dark.....	196
7.2.2	NGOs and religious organisations: a thorn in the side?.....	196
7.2.3	Academic and professional bodies.....	199
7.2.4	Media and private companies.....	200
7.3	Summary.....	202
Chapter 8	The 'Big Men' Supreme.....	203
8.1	The Donor Scene - 'He who pays the piper...'	203
8.1.1	Power balances and constraints.....	203
8.1.2	Donor-MoH relations: shifting sands.....	207
8.2	Hierarchy and Politics in the MoH: Implications for Reproductive Health Policy.....	211
8.2.1	Structural flux: the powers within.....	212
8.2.2	'Big-men, small-boys' and hierarchies of status.....	217
8.3	Summary.....	221
Chapter 9	Eyes for the Future.....	222
9.1	Policy Specifics and the Pervasiveness of Power.....	227
9.1.1	Service delivery level.....	227
	Clinical-technical and management issues.....	228
	Public health strategies and the targetting of men.....	228
	Medical practice hierarchies.....	229
	Social hierarchies.....	229
	Absentee-ism.....	230
	Activity paralysis.....	230
	Summary and discussion.....	230
9.1.2	Community level.....	231
	Health priorities and experiences of poverty.....	231
	Sexual practices.....	231

Social-sexual power structures and dynamics of respect.....	232
Traditional interpretations of STDs and AIDS.....	232
Summary and discussion.....	233
9.1.3 Regional level.....	233
Decentralisation and ambiguities.....	234
Resource deficiencies and national constraints.....	234
Importance of money.....	234
Hierarchies of status.....	235
Summary and discussion.....	235
9.1.4 National level.....	236
Balancing need and donor agendas.....	236
Power and money: MoH interests.....	237
Distancing the local voices.....	237
Summary and discussion.....	238
9.1.5 Conclusions.....	238
9.2 The Way Forward: distant voices in the corridors of power?.....	239
9.3 Towards the Future?.....	244

Appendices.....	246
------------------------	------------

Bibliography.....	307
--------------------------	------------

List of Appendices

Appendix 1	Interviews conducted.....	246
	Table A National level.....	247
	Table B Regional level.....	254
	Table C District level.....	256
Appendix 2	Health facilities visited during fieldwork. Upper East Region 1996-7.....	258
Appendix 3	Documents analysed during fieldwork and write-up.....	262
Appendix 4	Topic Checklist for key informant interviews.....	272
Appendix 5	Observation checklist for facility visits.....	276
Appendix 6	Interview checklist for semi-structured clinic staff interviews.....	278
Appendix 7	Key policy documents and their content.....	285
Appendix 8	Ranks of staff cadres in the Ministry of Health.....	288
Appendix 9	Laboratory tests available in the Upper East Region 1997.....	291
Appendix 10	STD drugs included on the Essential Drug List classifications and WHO/GoG STD algorithms.....	293
Appendix 11	STD infections and symptoms; WHO and GoG guidelines for management.....	295
Appendix 12	Policy discussion foras.....	298
Appendix 13	National and International NGOs working in health.....	301
Appendix 14	Academic and professional bodies involved in health.....	305

List of Tables

Table 1.1	Total number of health facilities visited and number as percentage of total health facilities in the Upper East Region, by facility type.....	24
Table 1.2	Staff interviewed, by rank, Upper East 1996-7.....	24
Table 2.1	Comparative STD statistics for selected African countries.....	49
Table 2.2	Comparative HIV statistics for selected African countries.....	50
Table 3.1	Comparative statistics for Upper East Region and Ghana: Incidence of AIDS; maternal mortality rate; FP and ANC coverage.....	62
Table 3.2	Health facilities visited and staff interviewed; Total facilities and staff in the Upper East, by facility type.....	63
Table 3.3	Number and percentage of facilities visited in each of the six districts in the Upper East Region.....	65
Table 3.4	National guidelines on clinical STD management policy, and practice.....	69
Table 3.5	Type of referrals for STD case management at facilities in the Upper East, 1996-7 (n = 27).....	84
Table 3.6	Summary of STD management practices at facilities in the Upper East, 1996-7.....	90
Table 3.7	Public Health management policies, and practice.....	92
Table 3.8	Summary of public health management practices in the Upper East, 1996-7.....	103
Table 5.1	Comparative costs of selected items in Bolgatanga, as at end 1997.....	129
Table 5.2	Common local names, causes and treatments of STDs, Binaba-Zonguire, Focus group findings, 1997.....	135
Table 6.1	Chemical sellers and pharmacists in Upper East, 1997.....	164
Table 7.1	Donor influences on the reform of Ghana's Population and Family Planning Programme.....	183
Table 7.2	MCH/FP and STD/HIV Programme structures.....	188
Table 7.3	Major donors in HIV/AIDS, STDs and MCH/FP.....	191
Table 7.4	Media Activities.....	201
Table 8.1	Personnel changes in key MoH posts 1996-7.....	216
Table 9.1	Contextual factors influencing STD/HIV and MCH/FP policies.....	224

List of Figures

Figure 1.1	A Framework for Policy Analysis (after Walt and Gilson 1994).....	9
Figure 1.2	A Model of Contextual Factors Influencing Policy.....	10
Figure 3.1	Upper East Region in relation to Accra.....	60
Figure 3.2	Selected reproductive health indicators as a percentage of all clinically recorded communicable disease cases. National and Upper East Region 1995-6.....	62
Figure 3.3	Upper East Region showing settlements where health facilities were surveyed.....	64
Figure 3.4	Selected characteristics of 27 facilities visited in Upper East.....	67
Figure 3.5	Percentage facilities with selected clinical equipment available.....	67
Figure 3.6	Typical hierarchy of services and referral pathways, Ghana 1998.....	68
Figure 3.7	Number of facilities with staff treating STDs, by staff type, Upper East Region 1997 (n = 27).....	70
Figure 3.8	Rank of medical officers in charge, by number of facilities visited, Upper East Region 1997 (n = 27).....	71
Figure 3.9	Facilities with staff who attended STD/HIV trainings held in the Upper East 1994-7, by staff type (n = 27).....	73
Figure 3.10	Staff (of 84 interviewed) attending STD/HIV training since 1994, by staff cadre and training level, Upper East 1997.....	73
Figure 3.11	Percentage of FP providers (of 38 interviewed) who have received some type of STD/HIV 'training'. Upper East 1997.....	74
Figure 3.12	Facilities performing syphilis screening and vaginal examinations, Upper East 1997 (n = 27).....	75
Figure 3.13	Laboratories with capacity for selected STD/HIV testing, Upper East Region 1997 (n = 27).....	81
Figure 3.14	Number of MCH/FP units with STD drugs on site (n = 27).....	85
Figure 3.15	Number of facilities experiencing stockouts of drugs and contraceptives, Upper East 1997 (n = 27).....	86
Figure 3.16	Common prescriptions and stockouts of recommended STD drugs, Upper East 1996.....	87
Figure 3.17	Facilities giving talks on STDs (n = 27).....	93
Figure 3.18	Facilities giving AIDS talks (n = 27).....	93

Figure 3.19	Facilities doing outreach education (n = 27).....	96
Figure 3.20	Facilities with condoms on site and doing condom advocacy (n = 27).....	100
Figure 4.1	Map of Bawku West sub-district.....	106
Figure 4.2	Hut compounds surrounded by tilled fields.....	107
Figure 4.3	Grain stores and huts in the chief's compound.....	108
Figure 4.4	Courtyard with shea nuts drying.....	108
Figure 4.5	Bore-hole with mango tree in a walled garden behind.....	109
Figure 4.6	Organogram of Actor-liaisons in Bawku-West District and Binaba- Zongoire sub-district.....	112
Figure 4.7	Binaba Health Centre and compound.....	114
Figure 4.8	The Bore Hole providing water for the Health Centre and the townspeople.....	114
Figure 4.9	Examination room in the maternity wing.....	115
Figure 4.10	The Injection room and registration desk.....	116
Figure 4.11	Malaria patient on a drip in the consulting ward.....	116
Figure 4.12	Dispensary.....	117
Figure 4.13	Child Welfare Unit.....	118
Figure 6.1	Organogram of actors involved in Health in Upper East Region.....	152
Figure 6.2	Flowchart of funding mechanisms.....	156
Figure 6.3	Drug and contraceptive flows.....	161
Figure 6.4	Reporting and administrative flows.....	166
Figure 6.5	Official and estimated annual incidence of STDs and HIV/AIDS in Upper East Region 1995-6.....	169
Figure 8.1	Organogram showing structure of MoH as at September 1997.....	213
Figure 9.1	Model for Understanding Influences on the Policy Process.....	223
Figure 9.2	Contextual Factors Influencing the Policy Process.....	226

III

Acronyms

AIDS	Acquired Immuno-Deficiency Syndrome
ANC	Ante-Natal Care
CBD	Community Based Distribution/Distributor
CHN	Community Health Nurse
CHW	Community Health Worker
CIDA	Canadian International Development Agency
CPR	Contraceptive prevalence Rate
DANIDA	Danish International Development Agency
DFID	Department for International Development (UK)
EC	European Community
EN	Enrolled Nurse
FP	Family Planning
FPRHP	Family Planning and Reproductive Health Programme (USAID)
GBC	Ghana Broadcasting Corporation
GDHS	Ghana Demographic Health Survey
GHANAPA	Ghana Population and AIDS Programme (USAID)
GMoH	Ghana Ministry of Health
GNMWC	Ghana Nurse and Mid-wife Council
GoG	Government of Ghana
GRMA	Ghana Registered Midwives Association
GRNA	Ghana Registered Nurses Association
GSMF	Ghana Social Marketing Foundation
GTZ	German Technical Development Agency
HIV	Human Immunodeficiency Virus
ICPD	International Conference on Population and Development (Cairo 1994)
IEC	Information, Education and Communication
IPPF	International Planned Parenthood Federation
IWHC	International Women's Health Coalition
JICA	Japanese International Development Agency
JHPIEGO	Johns Hopkins Program for International Education in Health
MCH	Mother and Child Health
MoH	Ministry of Health
MW	Mid-Wife
NACP	National AIDS Control Programme

NCP	National Council on Population
NCWD	National Council on Women and Development
NFPP	National Family Planning Programme
NGO	Non-Government Organisation
ODA	Overseas Development Agency (UK) (now DfID)
OPD	Out-Patients Department
PHC	Primary Health Care
PHN	Public Health Nurse
PI	Principle Investigator
PIP	Population Impact Project
PPAG	Planned Parenthood Association of Ghana
RHI	Rural Help Integrated
SCF	Save the Children Fund
SMO	Senior Medical Officer
SRN	State Registered Nurse
SRNMW	State Registered Nurse Mid-wife
STD	Sexually Transmitted Disease
StfNMW	Staff Nurse Mid-wife
TBA	Traditional Birth Attendant
TFR	Total Fertility Rate
UNFPA	United Nations Fund for Population Activities
UNICEF	United Nations Children's Fund
USAID	United States Agency for International Development
VD	Venereal Disease
VHW	Village Health Worker
WHO	World Health Organization
WHO/GPA	World Health Organization Global Programme on AIDS
WHO/HRP	World Health Organization Human Reproduction Programme

Acronyms for all cadres of clinical and public health staff are also provided, by rank, in Appendix 9.

CHAPTER ONE

INTEGRATING STD/HIV AND MCH/FP SERVICES: WHAT, WHERE, WHY AND HOW

1.1 INTRODUCTION: WHY INTEGRATE REPRODUCTIVE HEALTH SERVICES?

The question of integrating Sexually Transmitted Disease/HIV (STD/HIV) services with Mother and Child Health/Family Planning (MCH/FP) services is gaining an increasingly important place on health policy agendas. Historically STD and FP programmes have each been afforded very different status by the international health community and have been organised under separate physical, financial and organisational remits. Over the last decade however, a number of rationales have emerged to force policy makers to give serious consideration to integrating these services.

Until the advent of AIDS in the 1980s, STDs were considered a low priority public health problem in need of significant injections of financial and other resources (WHO/VDT 1985; Piot et al 1988; Population Reports 1993a). The AIDS epidemic drew attention to the problem of STDs in general and a subsequent increase in surveillance shows 15-30% sexually active adults are infected with an STD and approximately 10% of adults are infected with an STD each year, indicating that STDs should be treated as a public health priority in themselves (Wagner et al 1994; Meda et al 1995; Ronald 1998). The highest levels of STDs and AIDS are found in Africa (Gilks 1997; Ronald 1998). The recent confirmation that STDs can increase the risk of HIV transmission, added urgency to the question of their effective treatment (Grosskurth et al 1995; Mayaud et al 1997). Nevertheless, despite escalating interest, STD programmes remain poorly resourced and in need of 'new avenues for prevention' (Sai 1995). They are predominantly specialist, medically orientated services dependent on a reliable drug supply, targeting and reaching primarily 'high risk', urban, and male populations (Cates and Stone 1992a; Population Reports 1993; Meda et al 1995). By contrast, MCH/FP has much wider coverage than STD/HIV services and has been on international health policy agendas since the 1950s/1960s, enhanced through the expansion of primary health care services from the late 1970s on and attracting substantial funds and resources from donors. Integrating the two services has been proposed by development workers and donor agencies as a way of securing additional resources for STD/HIV

programmes (WHO-HRP 1990-1, 1992-3, 1994; Dodd 1994; World Bank 1994; Tsui et al 1997).

The remit of FP programmes has also changed. Where once family planning was offered as a service separate from MCH, this is much less often the case today. The goals are changing too; family planning programmes were formally driven by narrow goals of 'population control', today MCH/FP services are increasingly moving towards offering broader more integrated reproductive and sexual health services (Brown 1987; ICPD 1994; Tsui et al 1997). As part of this expanded role for FP, serious attention is being given to the question of integrating Sexually Transmitted Disease/HIV (STD/HIV) services into Family Planning/Mother and Child Health (FP/MCH). Women are affected by STD infections more adversely than men, which can result in maternal and pregnancy related complications and infertility. Many women are asymptomatic and infections are hard to identify until complications occur. Further, the experience of STDs by family planning clients may negatively influence their perception of FP if they attribute the STD symptoms to their contraceptive method (Cates and Stone 1992a; Population Reports 1993; Pachauri 1994). FP/MCH services are largely decentralised, emphasising locally-orientated services, providing clinical and outreach care to both urban and rural women; for many women this represents their only contact with health service provision. It is therefore suggested that FP programmes should also offer STD treatment, extending the reach of STD/HIV services to wider populations, and ensuring more comprehensive reproductive health care for women attending FP/MCH clinics.

Emerging consensus on the need for a wider view of reproductive health has given further leverage to consideration of integrating services, strengthening conceptual links between FP, reproductive and sexual health and STDs and involving an expanding cast of actors (WHO-HRP 1990-1, 1992-3; Ford 1993; ICPD 1994; UN 1995; Correa 1997; Tsui et al 1997). Activists for women's rights and sexual and reproductive health, and anthropologists stressing the social dimension of STD/HIV infection and care, have joined the clinical researchers, policy makers and FP/STD programme managers as actors in the reproductive health arena (ICPD 1994; UN 1995). The proliferation of women's health organisations, such as the Prevention of Maternal Mortality Network and International Women's Health Coalition (IWHC) began, in the late 1980s/1990s, to link STDs to maternal and gynaecology related complications in addition to restating the role of FP in reducing these (National Research Council 1989; Dixon-Mueller and Wasserheit 1991; Finkle and McIntosh 1994; Tsui et al 1997). STD/HIV infections are now regarded as a significant hazard to

reproductive health which requires more effective treatment - integration into FP/MCH provides an obvious mechanism for reaching women, who may not use health services at any other time, at key points in their reproductive cycles (IWHC 1991, 1994; Bastos dos Santos et al 1992; Cates and Stone 1992a; Shultz et al 1992; Population Reports 1993, 1994a; Tsui et al 1997). Various points of overlap in the remits of STD/HIV and FP/MCH programmes also argue for integration. Both conduct physical examinations and use swabs and slides (Finger 1994). Detection and diagnosis of STDs are difficult, therefore preventive strategies like counselling, education and condom promotion, are being emphasised. These activities are already accepted components of FP/MCH programmes.

Cost-effectiveness and accountability of resources are crucial issues for donors and governments. Despite a lack of comparative cost-effectiveness studies or evaluation and cost analyses of existing integrated programmes, the scale of the STD/HIV problem and the escalating costs of treating these infections and their sequelae, together with the perception that the two services currently have some overlap in their remits, have nevertheless encouraged programme financiers to seriously consider integration as a cost effective and necessary policy. Moreover, the prevailing global rationale is for ensuring women's reproductive health as a basic human right (UN 1995; Correa 1997)¹. In this context, governments and donors will be keen to be seen to concur and providing integrated 'reproductive health' services as part of health sector reforms would be evidence of commitment.

While rationales appear to converge, encouraging international consensus on the need for integrated reproductive health services, universal definitions as to what these services should constitute are lacking, and different stakeholders have different priorities and concerns. The crucial question facing researchers and policy makers is to what level and under what circumstances is integration of these services appropriate? On the one hand, STDs/HIV have implications for reproductive health, and there is some overlap in objectives and procedures of the two services. On the other, the treatment foci may be incompatible and there are issues of stigmatisation of STD/HIV services which could impact negatively on FP/MCH. There are also independent issues around STD/HIV management which integrated services will need to

¹ While the Plan of Action agreed at Cairo (1994) recognised the importance of empowerment of women for securing their reproductive rights, the Platform of the Second UN Conference on Women in Beijing took the issues further and succeeded in negotiating an acceptance that 'The human rights of women include their right to have control over and decide freely and responsibly on matters related to ... sexual and reproductive health' and, more significantly, that 'it is the duty of states, regardless of their political, economic and cultural systems, to promote and protect all human rights and fundamental freedoms' (UN, Beijing 1995). While implementation of such rhetoric will be a different story, the consensus is at least a step in the right direction.

address. STD diagnosis is highly problematic since many infected people, especially women, are asymptomatic and there is a dearth of cheap, reliable diagnostic tests and treatment regimes. There are problems with self-medication and with the availability of drugs for STD treatment, which require co-ordination with national Essential Drugs Policies. There are also many unanswered questions around contraceptive choice, safety and new contraceptive methods providing dual protection from STDs and unwanted/unsafe pregnancy (Cates and Stone 1992a, 1992c; Bantos dos Santos et al 1992; Tsui et al 1997). The key issues of concern emerging from a review of the literature are presented in chapter two and cover: costs and funding; organisation and management; resources, remits and workloads; clinical issues (efficacy of the syndromic approach, issues of contraceptive choice) and provider/client issues (treatment focus and stigmatisation).

The few evaluations that have been undertaken of existing integrated programmes indicate integration is feasible if it is locally conceived, taking into account a variety of location-specific criteria. Understanding local conditions is imperative if guiding criteria are to be developed on what to integrate, how and when, yet little country specific analysis has been undertaken. This study aims to provide a detailed understanding of the conditions and policy mechanisms in one case country currently undergoing major health sector re-structuring, to determine what should and could be integrated and how this would be consolidated in terms of practical implementation.

An understanding of the situation in Ghana with regard to the provision of services relating to reproductive health is particularly pertinent at the present time²: Ghana's maternal mortality rate is one of the highest in the world; prevalence of STD/HIV cases, while still low, is growing; there is escalating donor and government interest in integrated approaches to reproductive health; and new ways of managing scarce resources are constantly sought. A policy analysis approach is considered opportune since Ghana is currently going through a phase of major health sector reform in an attempt to reduce costs and improve performance (Cassels and Janovsky 1992; DFID (ODA) 1992). A policy analysis framework will clarify the situation by illuminating how the policy process operates, who is actively involved in making and influencing policy, why current programmes have developed the way they have, and which future directions will be most feasible. Research can influence health policy and has done so already in Ghana (Adibo et al 1996). In the sensitive area of reproductive health policy, which interfaces with the intensely private domain of conjugal power structures and

² For a detailed rationale for choosing Ghana as a case study, see section 1.5.2 below.

sexual decision making, research can play a particularly valuable role in informing policy decisions.

1.2 ORIENTATION AND SCOPE OF THE STUDY: JUSTIFICATION FOR A POLICY ANALYSIS APPROACH

This study applies a policy analysis approach to the issue of integrating reproductive health services, to provide a country-specific case study of current and potential policies in an environment of health sector reform. Despite proliferating arguments for integrating services for reproductive health, there are major research gaps in this field. There is scant documentation of country-specific case studies, many merely providing operational description³. Those extant suggest that while integration is possible at different levels and in different contexts, successful programmes need to be location-specific, dependent on local epidemiology, organisational, financial and resource bases and capacities, and the socio-cultural values of the country. In depth, country-specific studies are lacking which would provide an understanding of these criteria to assist decision makers. In particular, case studies of health service delivery frequently fail to take this whole range of issues into account. The case study approach of this research is a contribution towards filling this gap.

The current climate of changing policies in the health sector has warranted increasing attention to the policy dimensions of health care provision. A policy analysis framework is considered particularly useful for analysing and understanding the complex, multi-faceted issues around integrating reproductive health services, and synthesising the claims of the diverse parties involved in a changing environment. Policy analysis has rarely been applied to the health sector, and policy aspects and implications of integrating STD/HIV and FP/MCH services have never been systematically researched. Policy analysis offers a multisectoral approach which will clarify what appropriate provision of reproductive health services entails in a given context and how it can be achieved.

Ghana was chosen as a case country for a number of reasons detailed in section 1.5.2. The focus of this research will be on what is happening at the implementation level of reproductive health services provision. Given the constraints associated with a Doctoral thesis one region only was chosen for analysis of policy implementation in order to obtain an in-depth, quality understanding of how policy is actually consolidated at grass-roots level.

³ These are detailed in the review of the literature in chapter two

The predominantly rural Upper East Region was selected for a number of reasons. Rural areas of Ghana are the most deficient in effective health care, and rural women are invariably the least well catered for, particularly in terms of reproductive health services. The Upper East merits particular attention since it is one of the most deprived regions in Ghana. It has significantly lower than national levels of health facilities, and an institutional maternal mortality rate twice the national average at 500/100 000 live births (GMOH 1995b, 1996a; GMOH(UER) 1995a, 1996; Adibo et al 1996). While low levels of health seeking behaviour, poor ante-natal care and high levels of illegal abortion undoubtedly contribute to this, selected STD/HIV screening programmes suggest these infections also pose an increasing threat to maternal health by causing complications which can lead to death (GMOH 1994b).

It is acknowledged that the private sector (i.e. for profit, including 'formal' trained practitioners and pharmacists, 'informal' drug peddlers and traditional practitioners) is an important, largely unregulated, source of both family planning and STD/HIV treatment in Ghana, accounting for over 80% sales of short-term contraceptives - mostly through the Ghana Contraceptive Social Marketing initiative - (USAID 1994a). Although the percentage of STD/HIV services provided by the private (for profit) sector in Ghana is unknown, a recent USAID survey suggests that private GPs see more STD clients than the public sector (USAID 1994a). Other countries also document that most STD/HIV consultations occur in this sector, patients often preferring the anonymity it represents. While registered formal private sector practitioners are almost exclusively based in urban areas, the informal end of the private-for-profit sector provides the majority of health services in rural areas and is utilised by all segments of society (USAID 1994a; Norton et al 1995; Sylvester and Abu 1995).

The diversity of the private-for-profit sector precludes detailed country-wide analysis within the time and resource limits of Doctoral work. Moreover, in the rural Upper East region where poverty is widespread, public health services represent the only affordable means of health care. The focus of this research at all levels is therefore on *public* policy and service delivery strategies. Nevertheless, the need to include some consideration of the private sector provided another rationale for focusing the policy implementation aspect of this research in one region. At the community level it is possible to incorporate some understanding of the interaction between public and private sectors. In rural areas provision of health care involves 3 sectors: public, NGOs/Mission, and private-for-profit. There is an important interface between them which must be understood if meaningful research on the implementational viability of integration in Ghana is to be achieved. The numbers of

registered private practitioners in rural areas are small, allowing significant selection (75% registered, private facilities in the region were visited) to be taken in the time available. Traditional practitioners and drug sellers are too numerous and varied to allow a systematic analysis involving visiting and interviewing them. Some idea of the extent to which they are utilised as sources of contraception and STD drugs was gleaned from staff interviews.

It may be that integrated reproductive health services are best provided through collaboration between the sectors (personal communications and observation 1995-1998). Indeed, the MoH's newly framed strategies for health development include increasing partnership with the private and quasi-government sectors (defined as trained private practitioners and NGO/Mission organisations respectively), especially in areas where government services are sparse (GMoH 1993c; GoG 1995). Ascertaining the remits of the different sectors and any networking, formal and informal, between them, is crucial to understanding how services are implemented and how implementation of integrated services might be operationalised and make use of existing structures. In the words of one of Ghana's early promoters of 'family health', which, by extension, could read 'reproductive health':

"Good medical practice is to make use of the facilities at hand, and of the personnel available. The principle of adaptation is probably the single most important factor in introducing meaningful health services into a developing country, and it is especially so with regard to family health."

Williams, quoted in Ofosu-Amaah 1981

Such adaptation, and implementation of any formal policies, can only be achieved with an understanding of what service provision is already occurring and how it might be harnessed. This study aims to provide such an understanding.

1.3 CONCEPTUAL FRAMEWORK AND TERMS OF REFERENCE

'The most successful analyses are those which resist the temptation to build a formal theory and focus on concrete situations'
Palma 1978 cited in Quaye 1996:9

During the course of my research in Ghana, I have been struck by the lack of communication between the fields of policy analysis, including health, and those of ethnographic and anthropological research. The implications of this for policy development and implementation are profound. It became increasingly clear that donors, and often national

decision makers themselves, are extraordinarily ill acquainted with many of the contextual realities of both the national development and decision making arena and, more particularly, of the implementation environment. This is not to imply, however, that there is no cross-communication in particular areas of health research. Medical anthropology is a well respected and expanding field in its own right, but policy analysis seems generally to have been little informed by concepts and approaches of the anthropology field. This is partly because policy analysis has historically focused on macro-processes and national decision making (Walt and Gilson 1994) while anthropology has been pre-occupied with micro-level and specific cultural contexts (Young 1982; Morsey 1990).

No approach is completely satisfactory and it is imperative that research on issues as complex as health and provision of health services is informed by and spreads across as wide a range of relevant disciplines as possible. This study utilises a combination of approaches which put 'context' at the centre of analysis, resisting 'the temptation to build a formal theory' and focussing on the concrete reality.

1.3.1 The Policy Analysis Approach

Policy analysis has rarely been applied to the health sector and consequently substantive analyses and case studies are few. The mechanisms for analysis are informed largely by concepts from political economy but also draw on a number of other disciplines including public administration and the social sciences, offering a multi-sectoral perspective particularly suited to examining the multifaceted issues around changes in reproductive health policies (Walt and Gilson 1994; Walt 1995a; Barker 1996).

In many countries, including Ghana, health sectors have been or are undergoing major structural change, and health policy environments are increasingly characterised by conflict and uncertainty, demanding new paradigms in thinking about the health sector (Walt and Gilson 1994). Severe problems have been experienced in implementation of structural reforms in the absence of guiding criteria on *who* should execute policy changes and *how* to implement them (Walt 1995a). Hitherto policy analysis has concentrated on the *content* of policy, neglecting consideration of the context in which policies develop and are implemented, the processes by which policy is formulated and consolidated, and the influences of the actors who are involved at different stages (Walt 1994; Brinkerhoff 1996). Walt and Gilson (1994) proposed a more comprehensive framework for policy analysis involving consideration of these issues, viz. policy content; policy processes; the context of

policy formulation and implementation; and the actors involved. Their simple model is illustrated in Figure 1.1.

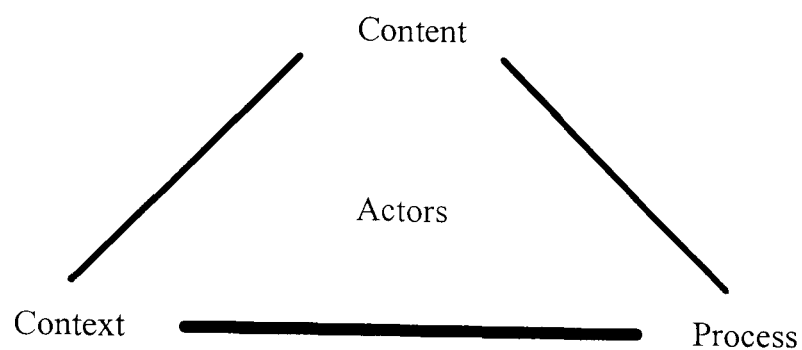

Figure 1.1 A Framework for Policy Analysis (after Walt and Gilson 1994)

Analyses of these four areas provided an organisational base for framing fieldwork questions and organising my material. My increasing conviction of the central importance of context, however, led to an iterative re-focusing of this framework in the field.

1.3.2 Context: The Crucial Concern

Walt and Gilson's framework for policy analysis puts context on the agenda as one of the key elements for health policy research. To bring context more overtly into focus, a useful conceptual approach is provided by the 'political economy in medical anthropology' school of thought. This is still an evolving and controversial field informed by writings from a range of disciplines (see Young 1982; Morsey 1990). Essentially it seeks to 'integrate analysis of global processes with ethnographic detail' (Morsey 1990:27). In doing this, the approach recognises that 'culture' pervades the political and economic spheres in a way that extends far beyond 'ethnomedical conceptions...to issues of power, control, resistance and defiance' (Morsey 1990:45). This concept of the need for macro and micro dimensions of analysis and the idea of an all-pervading cultural dynamic with resonance at all levels of decision making and operation, highlights the contextual aspect that is the focus of this research.

This thesis argues that all elements of policy and policy analysis are located within a contextual framework and are influenced by a range of contextual and cultural factors. It is argued that understanding the different levels of context is fundamental to understanding the processes of policy development and implementation, the actions of actors at all levels and the policy outcomes.

It is important to define the different clusters of ‘contextual’ factors. Three types are conceptualised here: ‘clinical/technical’ factors, ‘management/systems’ factors, and ‘social/behavioural’ (including ‘cultural’) factors. The nature of these factors together with examples of each are drawn out through the text. The examples given in the thesis are not exhaustive and the categories are by no means mutually exclusive. They should rather be seen as a ‘contextual continuum’. These can be illustrated with the help of a simple triangle which draws on concepts of organisational behaviour theory⁴:

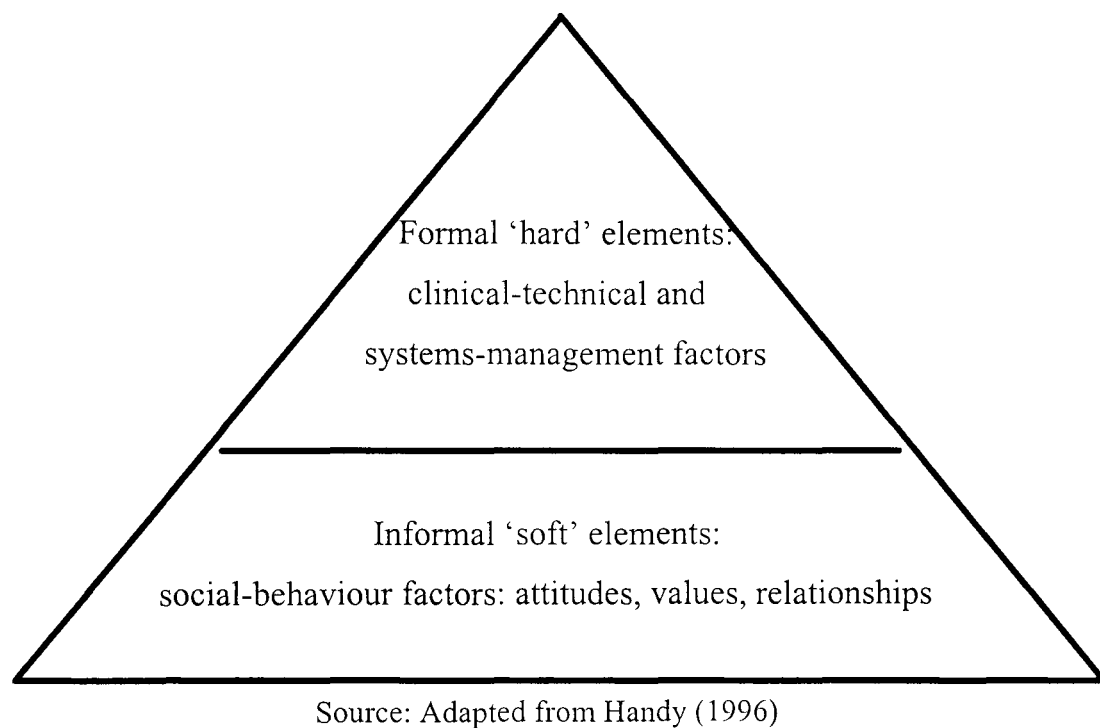

Figure 1.2 A Model of Contextual Factors Influencing Policy

1.3.3 Defining ‘Reproductive Health’ and ‘Integration’

‘Reproductive health’ is relatively new as a distinct concept and its definition is ambiguous. While comprehensive reproductive health services may include FP, MCH, safe abortion services (though this is a controversial component since abortion is illegal in many countries), prevention and control of STDs and HIV, counselling, infertility services, pap smears and general gynaecology and urology services, such a definition is, in most countries, only operational at district level or higher. For the purposes of this research, the focus is on integrating STD/HIV prevention and management strategies into existing MCH/FP programmes as a significant step towards providing more comprehensive reproductive health

⁴ See Handy 1996 and his ‘organisational iceberg’

services - the stance now taken by WHO, the World Bank and some independent researchers (WHO/HPR 1992-3; World Bank 1993b; Schneider 1995; Tinker et al 1995).

‘Integration’ is another woolly area of conceptual definition with sparse documentation of case studies to give clarity. Existing case studies are reviewed in chapter two; they suggest integration should probably occur at a variety of levels. The struggle over how to integrate health services and what integration means in practical terms has a long history which is not dealt with in detail here (see for example, Mills 1983). Suffice it to say that integration of reproductive health services necessarily involves the provision of some level of both STD/HIV management and MCH/FP care for clients during a single visit to a facility or outreach programme at primary and secondary health care levels. This will involve providers trained in both areas and able to offer advice and services for both FP and STD care during the same client consultation. It is not the aim of this research to develop a more precise definition of ‘integrated reproductive health’ since it is primarily a policy analysis. Nevertheless, the multi-level, multi-sectoral nature of the research facilitates a clearer understanding of what ‘integration’ and ‘reproductive health’ can realistically and appropriately mean in Ghana.

1.3.4 Power and policy: concepts and caveats

Thus far the conceptual discussions in this thesis have stressed the importance of taking up both macro and micro dimensions of reproductive health and policy issues. Any study of policy encounters the problem of power which is one of the central concepts in political science; little political discourse occurs without some reference to it. Yet ‘[t]he relations of power are perhaps among the best hidden things in the social body’ (Foucault quoted in Butchart 1998:177). The ambiguous, elusive and multi-faceted nature of power, means no adequate definition or measurement has been developed (Danziger 1991:134). Most literature on concepts and discourse on power falls in the realm of political science, political economy or public administration scholarship which deal with power at macro levels. Marxist and liberal-humanist discourse which has dominated decades of political, economic and medical thought, constitutes an essentially economic notion of power (Butchart 1998:170) which tends to subordinate an interest in and the implications of other types of power.

For an analysis of reproductive health policies, Foucault’s thinking on sexuality, medicine and society is useful since it spans a vast range of types and forms of power. In relation to sexuality he discussed the regulation of bodies and private lives through a medicalisation of

power and a 'clinical gaze' which intrudes to the most intimate parts of human lives. While it is beyond the scope of this thesis to take up these ideas for detailed consideration, what is important to keep in mind is that policies relating to health, particularly sexuality and reproduction, involve the complex interfacing of different types of power and any meaningful analysis and understanding of them must 'necessarily extend beyond the limitations of the state' (Foucault 1991:64). In an analysis of reproductive health policy therefore, the power of states and actors at the national level are but one part of the power equation. The state, as Foucault sees it, is simply a superstructure 'in relation to a whole series of power networks that invest the body, sexuality, the family, kinship, knowledge, technology and so forth...' (Foucault 1991:64).

What is lacking from most analyses of power by different disciplines are attempts to synthesise concepts and link these macro and micro dimensions of power networks to make sense of a whole process. While this thesis is not specifically a study of power discourses, power is recognised as a fundamental thread in the web of policy analysis and emerges through the discussion as a concept central to the understanding of the contexts influencing policy. At every level, power is best defined and understood through its manifestations - and its effects - since 'power creates itself in concrete practices' (Butchart 1998:32). At the national level, for example, power is mediated through influence - within the donor community and between donors and national government. At a local level, power is mediated through the notion of 'status' which defines interaction between different levels of health professionals, between nurses and the community and between men and women in the community. The various manifestations of power are identified and addressed at pertinent points throughout this thesis.

1.4 AIM AND OBJECTIVES

1.4.1 Aim

To provide a country-specific case study of reproductive health policy development and implementation which will enhance understanding of why there are differences between policy and practice which can inform future decisions regarding the integration of STD/HIV and MCH/FP services in Ghana.

1.4.2 Objectives

- 1) Identify the range of contextual factors influencing policy development and implementation in Ghana to help explain the differences between policy and practice.
- 2) Explore methods to expand the policy analysis framework by interpreting micro-level data for a better understanding of and response to the policy process.
- 3) Analyse processes of formulation and implementation of reproductive health policies in the MoH (through document analysis and key informant interviewing).
- 4) Determine the nature and content of current national policies on MCH/FP and STD/HIV and the context in which they developed (through document analysis and key informant interviewing).
- 5) Identify key actors at each stage of policy making and determine their involvement, positions and influence in the policy process (through interviewing).
- 6) Determine how policies are implemented by examination of MCH/FP and STD/HIV services at district and sub-district levels (using situation analysis and interviewing of providers and key informants).
- 7) Identify policy makers', implementors' and communities' perceptions of current services (efficiency, adequacy of supplies etc.) and of the possibility of integration (through semi-structured interviews and focus group discussions).
- 8) Explain the differences between policy formulation and its implementation and consider future policy and research directions pertinent to reproductive health services provision in Ghana.

1.5 METHODS

'...by directly experiencing the life of the people and by partaking in their daily rhythms, one can both listen to them telling about their world and be part of their social dynamism. The reality which emerges from this involvement makes the meaning of social existence very relative.'
Kodjo A. Senah 1997:208

This quote indicates two points relevant to my fieldwork: first the importance and unequalled insight obtained by living with a community; second that social meanings are relative and any judgements made by me are inevitably coloured by my own cultural background. They will also be interpreted by Ghanaians through their own particular cultural milieu.

Understanding policy at all its stages requires in-depth knowledge of the society in which the policy is developed and for whom it is intended. The best way to achieve this is through living in that community. At national, regional and sub-district levels, I was living entirely with Ghanaian families which enabled me to gain a far deeper insight into the Ghanaian mindset than would have been possible had I been living in a hotel, hostel or with a European. While one inevitably remains an outsider, personal contacts with my Ghanaian hosts over a period of 3 years, and family links with Ghana since my birth there in 1971, have offered me a better opportunity than many for understanding what it is to be 'Ghanaian' (as I was often told I was becoming myself).

This research was undertaken as a case-study and has been characterised by multi-level, research utilising a variety of research instruments. The approach, research tools and activities at each level are detailed here.

1.5.1 Case Study Approach

There are a number of justifications for choosing a case-study approach. It is particularly advantageous in terms of its depth and flexibility - attributes essential for research in a complex, ill-defined area such as reproductive health policy. A policy analysis case study allows for a multi-disciplinary approach which, given that no methodological approach can be complete, is imperative for achieving an in-depth understanding of the multiple facets of policy.

Moreover, there is a lack of case studies utilising policy analysis which needs redressing. No empirical work has systematically developed models or criteria to guide policy makers and programme managers on how and at what level services could and should be integrated. If such guidelines are to be generated, in-depth, country-specific studies are required to provide an understanding of the political and socio-economic context of programme development, the health sector resource base, and clinical and programmatic issues of STD/HIV and MCH/FP services. Detailed case studies are also much needed to allow comparisons of policy processes in different settings, and to enable policy analysis tools to be refined.

1.5.2 Ghana as a Case Study

No policy analysis has yet been undertaken of STD/HIV and MCH/FP services in Ghana despite major health sector re-structuring and increasing emphasis on integrated, primary health services. For a number of reasons, a case study analysis of reproductive health policies in Ghana and the possibility of their integration is particularly relevant at the present time.

Ghana is typical of many developing countries in its dichotomy between policy formulation and implementation of health policies and the differences in priority and resourcing of MCH/FP and STD/HIV programmes. At the national level the policies are formulated separately and managed under independent Units within the Ministry of Health (MoH), yet the reality of implementation is that services are offered within a more de-facto integrated framework. The recent decentralisation of decision-making and capacity within the health sector to district level was an attempt to remove some of the barriers to effective implementation, develop a more integrated approach to primary health care provision and manage scarce resources more effectively (Cassels and Janovsky 1992; Adibo 1992; ODA (DFID) 1994). Integrated reproductive health services fit this paradigm well yet little literature exists on integration of STD/HIV with MCH/FP services in Ghana and there have been limited attempts at government level to integrate them. While informal dialogue does occur between the staff, the links at an official level are limited and each programme director is keen to maintain his/her own power (Interviews, MoH staff 1995-1998).

An exploratory visit undertaken by the researcher in 1995 revealed increasing interest among national policy makers, clinic staff and other interest groups, in the possibility of integrating MCH/FP and STD/HIV services and support was expressed by the MoH for this research (Interviews, MoH staff 1995). Ghana already has a well established network of MCH/FP facilities and human resources (GMoH 1994b, 1995b, 1996a) to draw on. At a non-

government level, the issue of integration was explicitly addressed at the Second National Consultative meeting on Safe Motherhood in 1994 which considered the role of STD/AIDS care services in MCH/FP. Perhaps the most powerful rationale for integrated reproductive health services is the growing concern over the need to address Ghana's 'unacceptably high' maternal mortality rate (GoG 1995) which is one of the highest in the world (UNICEF 1992; Adibo et al 1996). Pregnancy and gynaecological complications (including those resulting from illegal abortion) are also consistently high (GMOH 1992a, 1993a, 1994a, 1994b, 1995a, 1995b). STD/HIV infection may be implicated in each of these and although STD/HIV prevalence is still relatively low, rates are rapidly increasing (GMOH 1993b, 1995c, 1996b; Pellow 1994; Dodd 1995) making their effective management imperative.

The political and ideological climate in Ghana seems to be receptive to the potential of integrating MCH/FP and STD/HIV services in an attempt to decrease maternal mortality, pregnancy/gynaecological complications and STD/HIV prevalence, and the country's resource base appears to have the capacity to support integrated programmes in an environment of political stability⁵. Integrated reproductive health ideologies have been endorsed by the Ghana Government, but operational strategies have yet to be developed. Ghana has reached a cross-road in its reproductive health policy choices and the success of future policy decisions and the development of implementation strategies, depends on an understanding of current policy processes and realities of implementation which is currently lacking. The insights provided by this research could provide valuable information for Ghanaian decision makers. The research will also provide a much needed case study for comparison of reproductive health policy options in other countries undergoing health sector reforms, contributing to the debate on how effectively reproductive health services are being provided in the wake of the 1994 Cairo Conference on Population.

In some ways Ghana can be seen as a touchstone for developing and assessing operationalisation strategies for reproductive health, since it is upheld internationally as a development (at least, an IMF) 'success' after receiving priority donor and World Bank attention for many years (World Bank 1993a, 1993b, 1994). The Ghanaian economy, while currently on a downward trend, is nevertheless one of the healthiest in sub-Saharan Africa (Financial Times special survey, 22 June 1998), and Ghana has more of a reputation for political tolerance than most of its neighbours. If integrated reproductive health services

⁵ There has been no major political upheaval in Ghana since 1981. The then military leader, Flt Lt J.J. Rawlings, has since been elected as head of a 'democratic', civilian government in 1992 and again in 1996. Although under the present constitution, Rawlings cannot stand again, contemporary commentators consider future political turmoil unlikely (personal communications 1997-8).

cannot be realised in Ghana, perhaps they cannot be realised anywhere in sub-Saharan Africa⁶.

1.5.3 Research Tools

Introduction

Policy analysis of the health sector is a young area of research and tools are constantly being developed and refined. Health policy is dynamic and therefore requires flexible research tools - those utilised in this research are primarily qualitative. Qualitative, inductive research offers the necessary flexibility and allows 'contextual understanding' (Bryman 1988) answering the often neglected questions *how* and *why* (Baum 1995); it is a dynamic, iterative process, not constrained to predetermined categories of analysis, maintaining the ability to encompass unanticipated results.

Qualitative methods best illumine why and under what social, economic and cultural circumstances, policies and their implementation occur in order to inform policy choice and enable policy makers to select appropriate guidelines and implementation measures (Leopradi 1993). A qualitative approach is particularly important in understanding policy issues round sensitive topics such as FP and STD provision and reproductive rights, which require understanding of attitudes and behaviour in a holistic socio-cultural context (Wynendaele 1993; Muecke 1993). Muecke maintains that '[a]n applied qualitative approach to reproductive health research would bring a more holistic view to the findings and recommendations for policy and services' (Muecke 1993:25). In addition, qualitative methods are particularly useful for policy analysis during times of change in order to better understand and inform the contexts in which attitudes are formed and decisions made, and the interactions between actors at different levels to clarify the ways power and participation are negotiated (Pope and Mays 1995a).

This research is historical and exploratory; the nature and operation of policy is examined at four organisational levels: national, regional, district and sub-district. Research questions and investigation were informed by the policy analysis framework outlined in section 1.3.1, and by a consideration of the issues documented in the literature review (chapter two) and of existing policy statements in Ghana concerning the question of integration of MCH/FP and STD/HIV services.

⁶ I would exclude South Africa from this statement because its unique political and economic history render its resource, organisational and management capacities very different from those elsewhere on the continent.

A triangulation of methods is utilised to enhance validity and provide greater analytical depth for a more holistic understanding of the policy processes and implementational realities of FP/STD policies in Ghana. The qualitative tools and the ways in which they were used in the field are now described in turn.

Political mapping and stakeholder analysis

Reich (1993) has developed a technique for assessing the political dimensions of changing health policy. It envisages five steps: a definition of the policy; assessment of the major players and their positions to the policy (stakeholder analysis); identification of the opportunities and obstacles to policy change; development of strategies to improve a policy's feasibility and an assessment of each strategy's likely impact on the position and power of the major actors (Reich 1996). Reich's political analysis methods have been applied primarily at the national level and are intended as a tool to influence national policy making and assess the feasibility and potential impact of new policies. These are not the objectives of the present research which are, rather, to discover who is influencing what at each level and so explain why policies are developed and implemented the way that they are, providing information which can inform future policy decisions. For this end the first two steps identified by Reich were adapted and utilised as fieldwork tools to systematically identify and understand the terrain at the national level. The rest of the research was concerned with understanding the opportunities and obstacles to reproductive health policy, not necessarily to outline different policy options, although through the findings some considerations of those can be drawn.

Using a snowballing technique (interviewees are asked to identify other actors they regard as important), informed by my reading of the policy literature and perusal of conference proceedings and meetings, the major players in reproductive health were identified, first at the national level and subsequently at regional, district and sub-district levels. At the national level the stakeholder analysis tool (based on writings by ODA (DFID) 1995, Reich 1996 and Crosby 1997) was adapted and used in the field to assess the relative influences of the different stakeholders. A table was drawn up describing the main actors, their interest and involvement in reproductive health policies (their position on and interest in the issue; their presence at policy meetings and seminars; their links with MoH and other key actors formally and informally), the type and level of their support (in terms of resources which could be mobilised, funding potentials) and the other actors with whom they worked and communicated (the frequency and nature of meetings with other actors). This information is

summarised in Appendices 1, 13 and 14. Following this, a rough position map was developed to indicate the clusters of actors involved in reproductive health policies and visually represent the strength of influence from different quarters. I have not included these in the thesis since they were primarily tools to assist my written analysis rather than instruments which could inform future policy. To be used for the latter would require a more rigorous preparation of criteria indicating opposition or support for a policy - as is described by Reich in his political mapping techniques. This was not a primary aim of the thesis, therefore the tool was used as a fieldwork instrument and not an analytical tool.

Finally the research took up an investigation of the obstacles and opportunities for change, not focusing solely on the national level, but at each stage of the policy process, identifying the influences on interpretation and implementation of policy, and utilisation of the services specified in policy. At this stage the research became broader and the focus was on defining the contexts of policy (which represent obstacles and opportunities) at each level, primarily using interviews and observational tools.

Document analysis

This is an indirect, unobtrusive, non-reactive method (Robson 1993) providing triangulation of data obtained from the more subjective interviewing techniques. It was used to provide the historical and technical background for understanding the mechanisms of the policy process. Primary and secondary information was reviewed relating to several areas: i) policy making processes, ii) the context and content of past and current STD/HIV and MCH/FP policies, iii) financial and resource flows, iv) the influence, roles and networking of key actors involved.

The content of reproductive health policies was defined by an exhaustive review of policy documents and Ministry of Health practice guideline manuals and directives and national nurse and MD training curricula covering maternal and child health, family planning/population, STD and HIV/AIDS. On the basis of these, questions were developed for the clinic-level interviews which sought to identify how far policies were being practised. These policies also formed the basis for my investigations during in-depth interviews with national level players, as to who had influenced policy development and in what ways.

A list of the key documents analysed is given in Appendix 3.

Key informant interviews

To determine roles and relative influences of key actors, official standpoints on STD/HIV and MCH/FP services and personnel perceptions of these services, interviews were conducted with a variety of informants. A comprehensive list is provided in Appendix 1; they include key MoH and donor officials, and heads of other organisations directly involved in policy making and implementation (including national government bodies, external donors, national and sub-national organisations, other overseas-based NGOs and church bodies). At all times the questions were highly flexible, based on a topic checklist (provided in Appendix 4) to aid the interview which was conducted, as far as possible, as a conversation (see Burgess 1982, 1984).

Key informants were purposively sampled based on their positions within the political structure of the Ghanaian Ministry of Health and relevant non-ministry organisations. Respondents were initially identified as key actors during the stakeholder mapping exercise, but the identification process also involved snowball and chain sampling strategies (initially selected respondents were invited to suggest others). The results elucidated, and to some extent cross-checked, the information obtained from the document analysis and stakeholder exercise.

Semi-structured interviews

In-depth, semi-structured interviews were conducted by the researcher with staff at regional, district and sub-district levels to supplement secondary data, using a question list as an interview guide (provided in Appendix 6). Interviews were manually recorded on paper at the time of asking and were often done in pairs by the principle researcher and a research assistant⁷. This approach allowed all material regarded by the researcher as important to be covered, while offering opportunities for respondents to identify further issues of concern and avenues of exploration. In-depth interviews generated data on experiences with programme activities and insights on programme impacts from the providers' perspective.

Staff interviewed included: hospital managers, sisters and nurses on the maternity wards, communicable diseases wards and in outpatients; special family planning nurses, midwives, public health nurses and community health nurses; and doctors involved with treating obstetric and gynaecological complaints and STD/HIV cases. Questions were asked to determine their perceptions of current services and their attitudes towards the possibility of

⁷ My two sisters acted as my research assistants for the main 3 month period of facility level interviews. They had just graduated from university and were well-briefed on the subject matter. They had both conducted interviews previously for their finals dissertations.

integrating STD/HIV and FP/MCH services. Interview topic checklists and lists of interviewees are provided in Appendices 5 and 1 respectively.

Situation analysis/structured observation at facilities

Time constraints made detailed inventories at each health facility unfeasible, therefore results were utilised from an extensive situation analysis of FP delivery points conducted by Ghana statistical services in collaboration with USAID and the Population Council in 1993 and 1995 (GSS 1994, 1996). These generate base line data on the current operational capacity of clinics and hospitals currently providing FP/MCH services, which include details of facilities and equipment (including drugs and storage conditions) and the adequacy of resourcing and of drug/contraceptive storage.

Structured observation in hospital wards and administrative offices at health facilities visited was undertaken to determine the general environment for FP and STD consultations and treatment. It acted as a triangulation for the interview and situation analysis methods, and gave depth to the insights provided by these, allowing the researcher an understanding of the programme setting, context of operation and atmosphere of consultations to an extent not possible using only secondary insights obtained through interviews. The observation checklist used is given in Appendix 5.

Media analysis

Media analysis was a minor part of data collection but was included to provide information on the media treatment of MCH/FP and STD/HIV issues and the way health topics are communicated to the population. A selection of the daily national newspapers *The Daily Graphic*, *The Chronicle* and *The Independent*, were regularly perused during the 12 month fieldwork period. During the months in the Upper East Region, a new weekly paper specific to the three northern regions, *Public Agenda*, had a brief circulation and was systematically studied during the fieldwork period to provide more localised news stories. Note was made of health topics presented in TV and radio programmes, and information on the procedures for and timing of health programmes run by the Ghana Broadcasting Corporation was obtained from the Health Education Unit of the Ministry of Health. Copies of MoH posters, billboard signs and information leaflets were also obtained from here. Attempts were made to determine funding sources and specifications.

The aim of the media analysis was to add context and depth to the understanding of national response to reproductive health issues rather than provide a systematic analysis of media as

an advocacy tool for family planning, AIDs and reproductive health messages. For this reason, media analysis results have not been presented as the findings of a separate exercise, but are incorporated in relevant chapters. In the national level chapters, media analysis provides information on the role of the mass media at the national level. At a local level, media coverage on health was not much in evidence; where it was considered pertinent, findings been included in the appropriate chapters.

1.5.4 Bias and Validation Techniques

The very strengths of qualitative research, its depth and flexibility, open it to various accusations. Certainly qualitative methods have a number of limitations regarding their internal validity (data depends on individual interpretations of situations and responses which can lead to researcher and respondent bias) and their transferability (findings of case studies and qualitative research are grounded in specific contexts and therefore may be non-transferable). These limitations are fully acknowledged by the researcher. However, the value of these methods outweigh their limits and weaknesses in internal validity can to a large extent be overcome using the following techniques:

- Systematic and rigorous use of triangulation (i.e. utilising a variety of data collection methods and sources) (Pope and Mays 1995b).
- Comprehensive, detailed record keeping and thorough auditing of the research process.
- Good supervision of the research process and peer testing of findings (as findings emerged they were shared with key informants for their response and feedback).

In general, the advantages provided by the depth of a qualitative case study approach are considered to overcome the disadvantages. Complex, changing policy environments and sensitive subject matter cannot be adequately understood through any other approach and researchers and decision makers disregard this at their peril.

1.5.5 Multi Level Research

The policy process involves actors and processes at a variety of levels from national formulation to local level implementation (Walt 1994; Barker 1996). To obtain a full picture of the nature and operation of reproductive health policy in Ghana, research was undertaken at four different levels: national, regional, district and sub-district. Details of activities undertaken at each level are now presented briefly.

Sub-District

In 1995 a period of three months was spent in a small village in Bawku West district. Since that time personal links have been maintained with a number of communities in the district. For the present research, a period of one month was spent in and around the sub-district of Binaba-Zongoire.

Staff at the health centre in Binaba were interviewed and observed to build up an understanding of the nature of service delivery. Interviews and informal conversations were also conducted with community leaders including church men, district assembly representatives and a number of personal acquaintances, about municipal structures and other organisations which have an impact on health delivery in the sub-district, and about perceptions of disease and health services among opinion leaders in the community. Representatives from other sector ministries, NGOs and church missions operating in the district and sub-district were interviewed about their role in supporting health and reproductive health activities.

To gain an insight into local perceptions of STDs, HIV/AIDS, family planning and sexual cultures, five focus group discussions, two male and three female, of 5-12 persons in each, were held with villagers from two villages, Gore and Tetaku, in the sub-district (see map in Figure 4.1, chapter 4). The majority of respondents were illiterate. Four focus groups were conducted on market days in Binaba when people from the outlying villages were available and one male focus group was conducted in a nearby village on a non-market day. The sampling was of men and women of childbearing age but was generally convenience. One female focus group was held with known contraceptors who were identified by their peers. The groups were called and the discussions translated at the time of the focus groups by a male traditional birth attendant (for the two male groups and one female group) and a female student (for two female groups) currently at teacher training college. Both were from Binaba-Zongoire sub-district. A pilot focus-group was conducted in Yelwoko village among a group of semi-skilled women.

Time constraints of this research mean the community level data are small and are necessarily informed by other research, in particular that produced by the Navrongo Health Research Centre. Nevertheless, it provides an important localised insight into social-sexual behaviours and disease perceptions which underline the necessity of understanding socio-cultural complexities if appropriate and effective policies for reproductive health are to be developed.

District

Over a period of 4 months, 94 clinical and public health staff were interviewed at 26 static facilities at regional, district and sub-district levels, and one large mission-run mobile primary health care unit in Bolgatanga district, making a total of 27 facilities (see Tables 1.1 and 1.2 below and Appendix 2).

In semi-structured interviews, questions were asked about what MCH/FP and STD management services they provided and how they implemented certain national policies relating to STD management within MCH, what problems they experienced and what their attitudes towards the policies were (see Appendix 5). Where available, official demographic, epidemiological and service coverage data was obtained from the regional statistician and from clinic records.

Table 1.1 Total number of health facilities visited and number as percentage of total health facilities in Upper East Region, by facility type

Type of health facility	Number health facilities visited in Upper East Region	Number visited as percentage of total number of health facilities
Hospital	4	100
Health centre	8	40
Private clinic	6	75
Mission clinic	3	15
MCH centre	3	n/a (accurate # do not exist)
Community clinic	3	27
Private laboratory	1	100
Total	27	c.35

Table 1.2 Staff interviewed, by rank, Upper East Region 1996-7

Staff Type	# Interviewed
Doctor	5
Medical Assistant	8
Senior nursing officer	7
State registered nurse midwife	13
State registered nurse	12
Public health nurse	7
Community health nurse midwife	8
Community health nurse	15
Staff/Enrolled nurse	9
Other (lab/pharmacy personnel)	10
Total	94

The 27 facilities were selected from three different lists of facilities operating in the area. The most up to date official lists dated from 1995 (GMOH 1995b, 1995c, 1996) and each recorded different numbers of facilities; examples of each of the six major types of health facility in the region were taken, including private and missions facilities which are included in MoH data bases (see Table 1.1) and at least 25% of registered facilities were visited in each of the six districts (see Table 3.3 in chapter three).

In addition, six chemical sellers were visited where a checklist was taken of STD drugs they had in stock, or commonly stocked and those out-of-stock or never stocked.

Regional

The regional hospital in Bolgatanga was visited and staff interviewed as at the district level, on the management of STD/HIV cases and its role as a referral and surveillance centre. District medical officers and regional health administration staff were interviewed to ascertain the role of the regional administration and the nature of funding and resource flows, administration and accountability mechanisms.

Regional representatives of NGOs and church organisations operating in the area were interviewed on their activities in the health sector and their spheres of networking. Regional officials from the Ministries of Agriculture, Education and Social Welfare were interviewed on their health-related activities and links with the MoH.

Directors and staff from the two regional training institutions, the Nurses Training College and the Midwifery Training School, were interviewed to ascertain numbers of new staff trained, training curricula and training capacities.

Use was made of the regional health administration library which stocks various national and regional MoH publications and policy directives. Regional newspapers were regularly perused for health-related articles.

The Navrongo Health Research Centre provided further documentation of community perspectives of family planning and health. In addition, research staff at the centre were presented with my preliminary findings and a seminar discussion allowed for valuable feedback from Ghanaian researchers in the region.

National

A complete list of Ministry, donor, NGO and other national actors interviewed is provided in Appendix 1. Each was interviewed to ascertain their activities, the nature and extent of support in the health field, their influences on the policy process, their networking patterns, and their views on current STD/HIV and MCH/FP policies, and on reproductive health and integration.

Ghana's two specialist STD clinics, Adabraka Polyclinic, Accra and Komfo-Anokye, Kumasi, were visited on several occasions to determine their operations and mandates in terms of treatment, laboratory testing and research. This was done through semi-structured and in depth interviews with staff, observation and collection of official clinic data and reports.

Korle-Bu teaching hospital, the national teaching hospital, was visited to compare the case load and treatment management of STDs within MCH/FP. Teaching staff were interviewed and curricula examined at the Ghana medical school, the nursing college and the midwifery school all on the Korle-Bu hospital compound to illuminate the content of current teaching on medical practice relating to STD/HIV management and FP/MCH. Staff interviews were also conducted at the national training facilities at Kintampo, where medical assistants are trained and technical field officers are now being trained according to newly integrated curricula combining nutrition and public health activities.

The national Public Health Reference laboratory at Korle-Bu was visited on two occasions to obtain information on national prevalence patterns of HIV and the three other STDs measured (gonorrhoea, syphilis and hepatitis B).

The Health Research Unit of the Ministry of Health in Accra provided my administrative base during the fieldwork period. Extensive use was made of its library which represents one of the most comprehensive collections of health-related documents in Ghana, including papers from ministry, donor, NGO and academic sources.

1.6 THESIS OUTLINE

'See what's happening on the ground, then when you've got a good grasp, go on to the next level...If you work backwards like that you won't be fooled.'
Director, School of Public Health, University of Ghana, Legon, 1996

Using a multi-level focus, this thesis identifies the contextual factors and their manifestations at each level of the policy process and illustrates *how* they impact on policy. As a result, a comprehensive framework has been developed, so as to understand the influences on and gaps between policy development and implementation, with the aim of informing future policy making.

Having spent three months at the community level in 1995, I was conversant with the types of issues involved in health care provision and utilisation. Before returning to Ghana in 1996, I further informed my knowledge and developed my research questions from an extensive literature search of the key issues around integrated reproductive health. The fieldwork itself started at the national level where interviews of national actors and document analysis were undertaken to inform the policy-specific research questions for the sub-national levels. After this I returned to the community level to assess how far implementation had taken place. For the purposes of the thesis I have reversed this order to show more clearly what and why there are such problems with implementation of reproductive health policies.

Implementation is often left as 'assumed' after the policy makers and national interest groups have congratulated themselves on the development of the policies on paper. One senior Ghanaian academic advised me in the words above to start on the ground and work backwards so that 'you won't be fooled'. Thus my thesis starts, after a literature review, at the implementation level to discover what is happening and why, in one rural region of Northern Ghana. From here successive chapters work back through the intermediate level up to the national policy development arena to discover if policies have been appropriately developed and effectively address the local level implementation issues.

The nature of each chapter is very different, reflecting the different types of material I am working with. Chapter two provides a detailed critical review of the existing literature in this field, indicating where the research gaps are and how this thesis contributes to filling them. Chapter three is the most quantitative, dealing with clinic level data on what STD management services are actually being provided in MCH/FP facilities in the Upper East Region of Ghana and what factors influence service provision (policy implementation).

Many contextual factors have an influence at this level and some attempt is made to reveal the complex interactions between them. Factors influencing service utilisation (which affect policy outcomes) are explored in more depth in the fourth chapter, and community perspectives are taken up in the fifth which highlights the more 'cultural' aspects of context. The content of these last two is necessarily much more qualitative. The sixth chapter looks at the role of the region as an intermediary between national and district levels, and so between policy development and implementation. Some understanding is sought of the concepts of power which influence administrative and management structures. The national level policy development scenario is the subject of the seventh and eighth chapters. These are also more qualitative, investigating how the different factors impact at this level and exploring further the concepts of power and status. Finally, all elements are brought together and discussed in the ninth and last chapter where the reworked framework is presented.

CHAPTER TWO

REVIEWING THE TERRAIN: INTERNATIONAL REPRODUCTIVE HEALTH IDEOLOGIES AND THE GHANAIAN CONTEXT

2.1 INTRODUCTION

Despite increasing international consensus on the need for integrated reproductive health services, detailed in chapter one, concepts of ‘integration’, ‘integrated services’ and ‘reproductive health’ remain opaque with little agreement on definition. This chapter first reviews briefly the international debates and ideologies which form the context for thinking about integrating reproductive health services, then details the specific issues of concern for integrating STD/HIV and MCH/FP services. The Ghanaian situation is taken up in the fourth section and finally, the limitations of current research are clarified which point the way for this study, illustrating its contribution to existing knowledge.

2.2 INTERNATIONAL DEBATES: VERTICAL VS. HORIZONTAL - WHERE DO FP/MCH AND STD/HIV PROGRAMMES FIT?

Policy and budgetary documents show that STD and FP programmes have each been afforded very different status by the international health community and have been organised under separate material, financial and organisational remits (World Bank 1984, 1993; WHO/GPA 1990a; WHO 1991; WHO-HRP 1994; Population reports 1991b, 1993; AIDS Analysis Africa 1993; IPPF 1993-4; UNICEF 1992; UNFPA 1995). These structures developed in the context of ongoing debates over whether health sector programmes in general should be provided through integrated or specialised structures. There is little consensus on the definition of ‘integration’ or ‘integrated services’. Before a definition of ‘integration’ pertinent to STD/HIV and MCH/FP services can be reached, it is necessary to understand the current differential structures of the two services.

Most family planning provision is based on the model of ‘horizontal’ ‘primary health care’ (PHC) developed in the 1970s (WHO/UNICEF, 1978; Brown 1987). As the rationale for family planning has moved from being narrowly focused on population control to a broader remit catering for reproductive health, the conflicting views of 1960s to early 1980s over the provision of vertical or integrated family planning programmes (Caldwell 1982; Bulatao 1984; Brown 1987; Cleland and Wilson 1987) has moved towards consensus (Brown 1987; Boyd and Phillips 1992).

Although some vertical family planning programmes do still exist in countries like Taiwan, Korea and Indonesia, most have become more integrated with MCH or primary health care services since the 1960s, and particularly after the 1974 Bucharest Population Conference when critical links were drawn between fertility decline and other sectors of development. Most family planning services are now provided through the public sector, are largely decentralised and locally-orientated (often linking with the private sector) under the auspices of MCH which is often substantially integrated into primary health care. There is heavy donor support for family planning services although in most countries government agencies also fund clinical support and outreach programmes for family planning which provide hospital based community nurses delivering condoms and oral contraceptives with some referral for sterilisation or IUD. Quasi-government agencies exist in several countries - in Bangladesh, Egypt and Zimbabwe, for example, they are managed by a board or council. Local private voluntary associations and IPPF affiliates operate in over 140 countries providing condoms and oral contraceptives, and sometimes the whole range (IPPF, 1993-4). Private sector commercial companies have set up in the Caribbean and elsewhere.

Although widely touted as 'integrated' many family planning programmes remain vertically organised programmes within primary health care or MCH⁸. Nevertheless, 'integrated' family planning programmes are the political and ideological 'norm' with emphasis on regional and district management, responsiveness to local conditions through outreach nurses and semi-trained community workers who deliver contraceptives, advice and education, and through involving local leaders, shopkeepers and various community groups.

Given the scarcity of funds and resources facing most developing countries, primary health care is increasingly regarded as an unattainable goal. Ideological conflict and difficulties in implementing primary health care initiatives during the economic hardships of the 1980s led to promotion of specific strategies and interventions, or 'selective primary health care' (SPHC) targeting certain key diseases (Walsh and Warren 1979; Evans et al 1981; Boland and Young 1982). STD services are examples of these specialised, vertical programmes which have faced considerable criticism (Berman 1982; Banerji 1984; Rifkin and Walt 1986; Unger and Killingsworth 1986).

⁸ Vertical FP programmes within MCH mean that the FP component of the MCH service will have a separate room, may be on a different day from other activities, has its own specially trained personnel and supply system for contraceptives (which are usually procured and delivered separately from other clinic supplies). Sometimes they may have separate supervision.

The Bamako initiative of 1987 was an attempt to revitalise primary health care facilities but the efficacy of its tenets remain equivocal. The model currently favoured by the World Bank, WHO, donors and some academics is that of an 'essential health package' provided through the district health model (WHO 1986; Smith and Bryant 1988; World Bank, 1993 and 1994). The essential health package represents a compromise. While recognising the need for an effective health system with comprehensive services which can address basic needs, it also understands that not all services can be delivered in such a system, so focuses on certain selective interventions including MCH-FP, STD/HIV prevention and some other reproductive health services.

Traditionally most STD/HIV services have been medically orientated, with vertical structures, specially trained providers stationed in specialist STD clinics, or in STD departments in district and provincial hospitals. Although some countries have initiated specific HIV/AIDS programmes under which STD control programmes are frequently placed, few developing countries have developed comprehensive STD control programmes. Where they are in place they are often administered under the Communicable Disease or Disease Control Units of the Ministry of Health organised vertically, in specialist settings and totally separate from MCH or FP. Zimbabwe is one of the rare examples where STD services officially come under the auspices of MCH/FP and PHC (Grosskurth et al 1993, 1995).

Specialised STD clinics theoretically offer an array of STD services, but they generally only cover small urban groups and have several disadvantages, especially for women who may feel stigmatised and ill-treated since specialist STD clinics treat mostly men (Fransen et al 1991). Some specialist intervention programmes have been implemented targeting 'high risk' populations such as prostitutes, lorry drivers and pregnant women, for example ante-natal syphilis screening and treatment in Zambia, and STD screening and treatment and condom promotion among prostitutes in Kenya and Thailand (Population Reports 1993). Pregnant women are often a focus of concern for STD campaigns because many of the complications resulting from STD infection are related to pregnancy, and can affect new-born infants and most women are diagnosed and treated during a visit to an ante-natal care clinic (Fransen et al 1991). The reality in many low-income countries is that STDs are being treated, often ineffectively, at the PHC level (in both public and private sectors) rather than in specialised clinics (Fransen et al 1991), and are facing major problems of cost and access to drugs.

Vertical and horizontal programmes exist simultaneously and at international and sub-national levels policy makers struggle to strike a balance between vertical programmes and integrated delivery systems. This is a particular challenge for disease programmes (like STD control) which require both clinical and public health strategies. The transition from vertical programmes to integrated primary health care services is characterised by changing mixes of the two (Smith and Bryant 1988) and there is increasing recognition of the need for a more sophisticated approach than is possible through the simple vertical/horizontal debate (Bradley 1998). Vertical programmes with their own command lines, staff and supplies, like most STD programmes, may be grouped alongside more generally integrated services. In a more integrated constellation, separate programmes may be integrated into primary health care services, as most FP and MCH/FP services are, though some programme components may continue to provide specialised staff and support to ensure continued effectiveness. 'Integration', or the combining of 'vertical' and 'horizontal' approaches, remains a particular challenge for programmes (like STD control) which require both clinical and public health strategies.

Over the last decade rationales from the spectrum of actors interested in reproductive health have been converging, encouraging consensus on integrating reproductive health services (Mayhew 1996; Tsui et al 1997). The key questions are: if and how to effectively combine medically dependent services like STD/HIV management which must reach both men and women, with broader based MCH/FP services which are female biased; and how to balance bio-medical treatment with public health prevention strategies. What aspects of these services can be integrated; at what level, under what circumstances is integration feasible?

2.3 REALITIES OF INTEGRATION: KEY ISSUES OF CONCERN⁹

Since 1995 (in the wake of Beijing) there have been increasing numbers of articles and books on female sexuality and women's reproductive rights, many of which talk of the need for STD/HIV management (Correa 1997; Tsui et al 1997). Some reports and journals have attempted to summarise integration issues and document case studies (notably Population Reports, Network and AIDS Analysis Africa). There have been few independent articles which give comprehensive treatment to practical delivery issues, especially those around contraceptive choice - of notable exception are Cates and Stone's (1992) chapters in *Reproductive Tract Infections*. Discussion of issues and case studies in an African context

⁹ This chapter to a large extent draws on my published review article, *Integrating STD/HIV and MCH/FP services: current debates and future directions*, which was an extended version of my original literature review for this research (Mayhew S. 1996, *Health Policy and Planning*, 11.4:339-353).

took place at a regional workshop on the integration of HIV/AIDS with MCH/FP held in Kenya during May 1995¹⁰ (*Setting The African Agenda*, 1995). This was the first regional meeting of its kind to discuss specifically the possibility of integrating STD/HIV and MCH/FP services and is symptomatic of the widespread concern in this area. There are many points of overlap in the two programmes, but there are many unanswered questions (Bantos dos Santos et al 1992; Cates and Stone 1992a; Pachauri 1994). Since the Cairo International Conference on Population and Development (ICPD) in 1994, many countries have been piloting integrated services under the 'Programme of Action' tabled at the conference. The Africa Region desk of the Population Council in Kenya is to host a conference this year (1998) at which case studies will be invited from all countries to facilitate assessment of the 'success' of operationalising the Cairo concepts and determine the future direction of reproductive health policies (personal communications 1998). The case-studies to be presented are ongoing and no details are currently available. Nevertheless, existing literature highlights several areas of actual or potential concern and these are considered here in turn.

2.3.1 Technical, Programmatic Issues

Costs/funding

This is probably the most critical factor for decision makers. Three main issues emerge, namely cost-effectiveness of integrated programmes, their relative and absolute costs, and funding sources and conditionalities. There is a dearth of data on comparative costs¹¹ between integrated and non-integrated services (Pachauri 1994; Sai 1995). The question for decision makers is whether the greater costs of staff training, drugs and clinical equipment, will be outweighed by the money saved from reducing STDs and sequelae needing treatment. The results from the extensive Mwanza trial in Tanzania suggest the treatment of STDs is a highly cost-effective way of decreasing HIV incidence and so saving disability adjusted life years (Gilson et al 1997; Ronald 1998). Although the generalisability of these results has been questioned, STD treatment is still considered a cost-effective intervention in terms of other medical costs saved (Schneider 1994; Mayaud et al 1998).

¹⁰ It was attended by 165 health-care professionals from 18 Sub-Saharan African countries, the US and Thailand. Other participants included USAID Population, Health and Nutrition officers, and senior Ministry of Health officials representing the areas of primary health care, family planning, and STD/HIV. There were also representatives from many NGOs that provide health care in Africa.

¹¹ There are currently no standard cost analysis methods for integrated programmes. FP programmes are usually evaluated in terms of 'couple years of protection' and STD programmes in terms of the number of patients served (Finger 1994).

Data available from WHO, the World Bank and academic researchers suggest that STD programmes are at least as cost effective as FP programmes and would therefore not overburden the latter (Over and Piot 1991; Bastos dos Santos et al 1992; Population Reports 1993; Shultz et al 1992; World Bank 1993; WHO-HRP 1994). Debate over the most cost-effective method of STD treatment is ongoing although there has been little evaluative research. Essentially services can either target 'high-risk' groups of 'core transmitters' as has been the case with many vertical programmes (Over and Piot 1991; Meda et al 1995), or, given the expense of treating STD sequelae, provide extensive screening and primary treatment which is likely to be far more cost-effective (Bastos dos Santos et al 1992; Shultz et al 1992; Schneider 1994). Where STD prevalence rates are high, mass treatment may be more cost-effective than screening¹² (Pachauri 1994), though this raises ethical questions. Different strategies for STD treatment will have different implications for integration. While extensive screening and mass treatment might easily be achieved through integrated and outreach services, targeting 'high-risk' groups who are unlikely to use FP/MCH services may require the more vertical, specialised approach currently employed. The chosen method should ideally reflect the epidemiological pattern of STDs in the country, although this requires extensive surveillance which induces extra costs.

If clinical programmes are to be effective (and cost-effective), preventive strategies, such as counselling and education, are also required to promote behaviour change and to address the gendered power relations in which males dominate sexual and reproductive decision making, which can render female FP and STD treatment ineffective (Ankrah 1991; Lane 1992; Prevention of Maternal Mortality Network 1992; Mbizvo and Bassett 1996; Mayaud et al 1998). STDs have been affected by the changes in social structures of lower and higher income countries (such as mobility, tourism, rapid urbanisation and disintegration of traditional family structures) which have encouraged 'high risk' behaviours facilitating the spread of HIV/STDs (Lee and Zwi 1996). Without outreach strategies to address these and which reach and include men, integrated programmes are likely to have only limited effect. Preventive strategies are seen as low-cost treatment alternatives and have been used with apparent success in a number of countries but most documentation omits discussion of costs (Mukaire 1995; Penxa and Blackie 1995; Twahir 1995; Rusakaniko et al 1997; Gerbase et al 1998). One counselling intervention was piloted in Malawi which concluded that counselling could be a low cost, effective strategy for STD control but even here no analysis was made of actual costs (Wynendaale et al 1995). While education and condom promotion might be

¹² The World Bank suggests mass treatment be employed when STD incidence reaches 10% of the population (World Bank 1993).

achieved by FP/MCH outreach programmes, STD/HIV treatment may need to be through general clinics and integration of STD services into all PHC level clinics should also be considered.

There is a growing literature acknowledging the cost-effectiveness, in terms of both financial and efficacy costs, of providing STD services with FP/MCH (Finger 1994; Population Reports 1993; World Bank 1993; Tinker et al 1995). It could optimise the use of existing resources reducing service delivery costs, and reduce client time and travel costs. Most literature predominantly considers integration of STD services with FP programmes, only including MCH in as far as most FP services are provided through the MCH network. Expanding the scope of FP/MCH services to include STD/HIV rather than categorically integrating STD and FP programmes may be a more feasible approach to integration (Pachauri 1994). There is growing interest in MCH (within PHC) in its own right as a more cost-effective way of reaching the largest number of women of reproductive age (Ghana National Consultative Meeting on Safe Motherhood 1994; WHO personal Communication 1996). The World Bank includes FP services, prenatal and delivery care and STD management as a fundamental part of its 'minimum package' of essential primary health services (World Bank 1993; Tinker et al 1995) and WHO recently convened an informal working group on integrating STD management into MCH (personal communications 1997).

The financing of programmes is subject to the general debate on health sector funding. Consensus among public health researchers is that given the preventative advantages of treating STDs, treatment should be free, funded by donors and central government (Grosskurth et al 1993; Gilson et al 1997). Some World Bank economists however, take the view that government intervention for STD/HIV treatment is not justified either on public health or economic grounds¹³. Where STDs are treated in non-specialised facilities user charges often already exist though their impact is equivocal. Some studies record falls in attendance at clinics after the introduction of user fees (Moses et al 1992; Grosskurth et al 1993) while others show clients are willing to pay for services if they think they are of a higher quality (Population Reports 1993; World Bank 1993). STD/HIV and MCH/FP services are differentially funded. The former have attracted fewer resources and national programmes rely heavily on donor funding¹⁴ (Bastos dos Santos et al 1992; Population Reports 1993; Shultz et al 1992; World Bank 1993; WHO 1994). Family planning

¹³ Arguments for intervention are denied on public sector grounds because STDs are seen to be caused by self-determined 'risk behaviours' and denied on economic grounds since public sector provision would subsidise potential private sector clients (personal communication 1996).

¹⁴ Key donors for STD programmes include the EC and its member countries, USAID, UNAIDS and the World Bank.

programmes are better resourced and public sector services are now largely funded by national governments of lower income countries (Population Crisis Committee 1990; Population Reports 1991b; UNFPA 1995). Integration is likely to have serious implications in terms of sources and quantity of funding. Lower income country governments may not be able to cover extra costs incurred by providing STD services at FP/MCH facilities; donors of STD/HIV programmes may not wish to see their budgets incorporated into wider, less quantifiable or accountable, MoH treasuries (Unger and Killingsworth 1986; Potts 1995). Given the strength of the rationales for integration, the latter may prove less of a problem particularly since, in the health sector generally, the trend is for donors to provide aid for health through multilateral channels, with increasing flexibility allowed for its designation and use at national levels (World Bank 1993, 1994).

Organisation and management

The question of whether specific health services should be provided through 'horizontal' or 'vertical' structures has a long history, covered in the introductory section, and the struggle to integrate programmes has continued since the 1950s and before (Mills 1983)¹⁵. The key organisational issue is that efficient management of STDs involves both clinic based treatment and preventive strategies which may require different delivery approaches.

Clinical services depend on an adequate drug supply and often require expensive laboratory equipment and skilled clinical personnel beyond the resources of many Ministries of Health, except through selected vertical services. Studies in Mwanza and Mozambique show that effective STD treatment is a function of access to drugs (Bastos dos Santos et al 1992; Grosskurth et al 1995). If adequate supplies are not available, self medication or incomplete drug dosages result in antibiotic resistance which then pose serious problems for decision makers (LeBacq et al 1993; Mabey 1995)¹⁶. TB control programmes face similar problems deriving from their necessarily drug-focused approach. Case studies from South East Asia underline the necessity of well established medical infrastructures for drug delivery (Chonde 1989; Tang Lin-Hua et al 1991; Chum 1991). Once in place however, integrating drug delivery into the PHC network has proved successful in these countries even in remote areas for example in Nepal (Onozaki and Shakya 1995; Zhang and Kan 1992). An adequate base for STD drug delivery could be provided by MCH/FP programmes in many countries where there is relatively good infrastructure.

¹⁵ Many attempts have been made to integrate other vertical programmes into horizontal structures, including malaria, TB and leprosy programmes. Some of the experiences can usefully inform discussion of STD-FP integration although most research has been carried out in South East Asia.

¹⁶ For example, in many parts of Africa more than 50% gonococcal isolates (which cause gonorrhoea and chlamydial infections) are resistant to penicillin (Mabey 1995).

Preventive strategies are increasingly recognised as necessary components of STD programmes although views on the effectiveness of such approaches remain mixed (Aral and Peterman 1998). Counselling and information/education programmes have been used to apparent effect in a number of countries (Ankrah 1991; Dallabetta 1993; Mukaire 1995; Penxa and Blackie 1995; Twahir 1995) although behaviour change messages directed solely at women may have low potential for STD prevention (Daly et al 1994). Counselling, education and condom/contraceptive distribution are already undertaken by FP providers, using various strategies. Contraceptive social marketing has been used, notably in Ghana, Bangladesh, Pakistan and more recently Ethiopia, and community distribution and outreach initiatives, in Zaire and Zimbabwe for example; both are well accepted by the donor community as legitimate, low-cost service delivery mechanisms (Osteria and Okamura 1986; IPPF 1987; Levy et al 1988; Forum 20.6-7, 1991; Hubley 1992; Pradervand 1992; World Bank 1993; PSI 1994; Lamptey and Goodridge 1996). Their remits could be extended to incorporate STD information and referral¹⁷ and may be the best way to reach hard-to-contact groups and to achieve the tracing of sexual partners of STD infected persons, which is essential for breaking the infection chain, but is notoriously problematic (Finger 1994; Mukaire 1995; Twahir 1995).

Given the need for dual strategies in STD control, Hellberg's suggestion that integrated TB programmes may need to retain a specialised unit and identity at a national level while integrating treatment services at a local level, has resonance also for provision of STD services (Hellberg 1995).¹⁸ Similarly Bradley urges a greater sophistication of approaches for Malaria control, which go beyond vertical and/or horizontal conceptions (Bradley 1998).

The private sector (both 'for-profit' practitioners, drug sellers and transnational corporations, and 'not-for-profit' NGO/Mission organisations) is a largely unknown quantity. It is acknowledged as an important provider of both FP/MCH and STD/HIV services (Population Reports 1991a, 1991b; AIDS Captions 1996) and there is increasing interest in public-private sector collaboration in providing these services, especially where national capacities are poor (Population Reports 1991b).

¹⁷ Other vertical programmes, for example Malaria control strategies in South East Asia, have already successfully utilised a community participation approach (Tang Lin-Hua et al 1991; Manderson 1992; Riji 1992).

¹⁸ This is in fact a common mode for integration and has been proposed for control strategies for other diseases.

Resources, remits and workloads

Given certain overlaps in the remits of FP and STD services, some researchers suggest that integrating services better utilises scarce resources avoiding duplication and improving cost-effectiveness and quality of services (Population Reports 1993, 1994b). STD/HIV infections can cause serious maternal/pregnancy related complications and therefore have implications for the safety and quality of FP services and the demand for contraceptives (Cates and Stone 1992a, 1992b; Pachauri 1994). Many medical professionals favour an integrated approach because it provides an opportunity to inform, screen and treat women for a variety of reproductive health conditions, including STDs and related pregnancy/gynaecological complications, and give appropriate contraceptive advice (Pachauri 1994; Population Reports 1994b; *Setting The African Agenda*, 1995:Appendix D).

Counter arguments suggest that offering a broader range of services would result in a loss of focus and a possible reduction in quality of services. Some integrated programmes in Africa note problems of overburdened and inadequately trained staff (Penxa and Blackie 1995; Kisubi 1995; Walsh and Pollock 1995). Some of the burden may be averted if community participation is introduced and family planning community workers take on STD diagnosis and referral activities, though case studies from South East Asia show the necessity of staff motivation and support for the success of integration (Manderson 1992; Riji 1992). There is particular concern that resources may be drained from FP activities, weakening the programmes, although Finger and Barnett (1994) surveyed case studies of integrated services from several Latin American countries, and found that integration of STD/HIV into FP/MCH does not necessarily weaken FP programme effectiveness or popularity; indeed it actively encouraged utilisation by some clients. IPPF affiliates in the Western Hemisphere Region document positive results from integrating services, taking care not just to 'tack on' STD/HIV services but actually change the way services are provided (Lauglo 1996).

2.3.2 Clinical issues

Clinical management and the syndromic approach

There is a paucity of cheap, reliable diagnostic tests for STDs, especially for gonorrhoea and chlamydia, despite ongoing research (IWHC 1991, 1994; Finger 1994; Population Council 1994; Vuylsteke et al 1993; Bourgois et al 1996; Choru et al 1996; Germain et al 1997). In addition, cheap, single-dose therapies need to be developed for all the major STDs to reduce the problems associated with patients not returning for STD treatment. STD services face

major problems of cost and access to drugs. These are exacerbated by the reality that many STDs are being treated, often ineffectively, at PHC level, rather than in specialised clinics (Fransen et al 1991). In an attempt to address the situation and make STD treatment more feasible for non-specialised personnel, WHO and STD experts developed the 'syndromic' approach to diagnosis and treatment (WHO/VDT 1985, 1989; WHO 1991; WHO/GPA 1994).

Providers diagnose and treat on the basis of groups of symptoms or syndromes, rather than for a specific STD, and treat for all diseases that could cause that syndrome (WHO/GPA 1994). The approach does not require extensive laboratory tests and is therefore affordable and feasible to integrate with family planning delivery which already undertakes physical examinations and utilises clinical equipment, for example taking swabs and using slides (Finger 1994). It allows patients to be diagnosed and treated during a single visit - currently patients may have to visit several locations - and is more reliable than clinical diagnosis (identification of the STD causing the evident symptoms based on clinical experience). It can be learned by primary health workers - clinical officers, medical assistants, nurses or nurse-midwives - and the simple flow-charts showing diagnostic and treatment procedures can be locally adapted (Finger and Barnett 1994; Schneider 1994). It is currently used with reported success in many countries including Botswana, Kenya, Nigeria, Senegal, Tanzania, Uganda, Zambia and Zimbabwe (Population Reports L9,1993; Finger and Barnett 1994; Aboagye-Kwarteng and Moodie 1995; Mukaire 1995; Twahir 1995). The treatment regimes are flexible to some extent and need to be sensitive to local STD/HIV epidemiologies and drug resistant strains (Ledru et al 1996). Locally specific alternative (cheaply available) drug treatment regimes were developed with apparent success in Senegal and Kenya (Network 14.4, 1994; Van der Veen et al 1994).

Health professionals have expressed concern over the appropriateness and effectiveness of the syndromic approach (Finger 1994; Pachauri 1994). A number of studies using syndromic algorithms to diagnose STDs found them variable or associated with low sensitivity, specificity and predictive values, particularly for women (Daly et al 1994; Behets et al 1995; Thomas et al 1996; Diallo et al 1997; Germain et al 1997; Gertig et al 1997). Where diagnosis with syndromic algorithms has been integrated with risk assessment factors, their sensitivity and specificity was increased (Vuylsteke et al 1993; Bourgois et al 1996; Bourgois et al 1998). This is particularly the case for diagnosis of women with gonorrhoea or chlamydia and WHO has now proposed that a 'risk assessment' step be added to the algorithm although the asking of such questions may prove socially unacceptable in Africa

(Mayaud et al 1998). Verbal risk assessment strategies have been advocated as a relatively easy way to integrate STD management with MCH/FP services but there is no evidence to show their effectiveness for screening low-prevalence populations (Welsh et al 1997; Bourgois et al 1998).

Many patients, especially women, are asymptomatic and in most women, clinical signs and symptoms are poor predictors of STDs (Gerbase et al 1998; Mayaud et al 1998). These clients can only be diagnosed aetiologically (with microscopy or laboratory tests). Unless screening programmes are implemented to detect asymptomatic patients, many are treated only once complications have already occurred and symptoms become apparent (Schneider 1994). Because the syndromic approach does not allow aetiological diagnosis, no distinction can be made between STDs and other causes of reproductive tract infections (Bastos dos Santos et al 1992). Syndromic protocols involve expensive over-treatment using scarce resources unnecessarily and raising ethical questions over treating uninfected persons and potentially subjecting women who are wrongly diagnosed as having an STD to serious social consequences (Finger 1994; Meda et al 1997; Mayaud et al 1998). Nevertheless, given the severe resource constraints of many developing countries, it is difficult to advocate a more feasible method. Tsui et al (1997) warn that the development of standardised treatment flowcharts for symptomatic clients is only a first step in the management of STDs. There will also need to be commitment to and investment in the training and retraining of providers as well as efforts to upgrade diagnostic facilities and ensure antibiotic supplies (Tsui et al 1997). There needs to be a simultaneous increase in treatment compliance and the encouraging of infected clients to abstain from sexual relations during STD treatment. Consultations should allow proper time for counselling, and various primary prevention strategies need to be improved including condom promotion, partner notification and treatment.

Contraceptive choice

Cates and Stone (1992a, 1992b, 1992c) give comprehensive treatment to the implications of integration for provision of contraceptives and review research on the relative effectiveness of each method for pregnancy prevention and STD control. They do not cover related ethical and socio-cultural implications in any depth. The pertinent issue is that the contraceptives most effective for preventing pregnancy (the pill, IUDs, implants and sterilisation) offer little or no protection from STDs; some studies suggest oral contraceptives and IUDs may even increase the risk of HIV/STD infection (Cates and Stone 1992a, 1992c; AIDS ALERT 1993; Sinei et al 1996; Gertig et al 1997). Condoms and some of the female-dependent methods

(sponge and diaphragm) may have significant preventive qualities for STDs (Rosenberg et al 1992) although they may not provide as effective a safeguard against pregnancy¹⁹. In addition, condoms, which are considered by many donors and providers to be key components of both family planning and STD programmes, have lower acceptability in developing countries and their use is subject to gendered power structures (Cates and Stone 1992a; Lande 1993).

Providers have to decide whether to recommend a contraceptive method primarily for STD protection or pregnancy prevention weighing a patient's potential exposure to STD infection and the possible increased risk of infection posed by some contraceptive methods²⁰, against potential complications arising from high-risk pregnancy. The mix of contraceptive methods available varies with the country and programme, and choice may be based on availability, cost, provider preferences, perceived 'risk' behaviour of the client, or programme policy. Some programmes advocate the use of dual methods to ensure protection from both unwanted pregnancy and STD infection (Cates and Stone 1992a, 1992c; Finger 1994). Others advocate at least the provision of information/education on the benefits and risks of each contraceptive method for preventing STDs (Creatsas 1997). A female-controlled microbicide providing adequate protection against both is being developed with support from several organisations (IWHC 1991, 1993; Population Council 1994; Tsui et al 1997). The issue of developing a vaginal microbicide effective against HIV/STDs without impairing conception is also under consideration and could be crucial in effective STD/HIV treatment since in developing countries more women are likely to accept a female STD prevention method if it is seen not to impair fertility (Elias and Heise 1994). Female condoms have also been piloted in a number of sub-Saharan African countries with initial enthusiasm (Deniaud 1997).

2.3.3 Provider Issues

Treatment focus

Despite some overlap in the treatment (examinations, use of slides and swabs) and prevention methods (education, counselling and condom promotion) of the two programmes, concern has been expressed that the fundamental differences in foci of STD and family planning programmes make them unsuitable for total integration (Pachauri 1994; Tsui et al 1997). The clinical treatment approach of the two programmes is totally different (Cates and

¹⁹ Although the global failure rate for condoms stands at 12% this is largely because of poor or inconsistent use rather than poor quality (Cates and Stone 1992b).

²⁰ Promotion of IUDs and oral contraceptives in high STD/HIV prevalence settings raises serious ethical questions.

Stone 1992a). STDs are treated with antibiotics, while family planning involves distribution of hormonal and barrier contraceptives, insertion of IUDs, and surgery for sterilisation or abortion services. Consequently the providers' approach is very different. STD patients usually receive directive counselling because they are sick. Family planning providers are non-directive in their approach, since they are essentially advising and supporting healthy clients to take preventive action (Cates and Stone 1992a). Distinct aspects of STD/HIV programmes, such as care for terminal AIDS patients, also need to be considered, though this is not an area of concern or financial significance in most lower-income countries (Ankrah 1991).

The nature of family planning counselling and provision has, nevertheless, clear implications for HIV/STD transmission, and vice versa, which argue for integration. The experience of STDs by family planning clients may negatively influence their perception of the services and demand for contraceptives if they attribute the STD symptoms to the contraceptive method (Cates and Stone 1992a; Population Reports 1993; Pachauri 1994). Provider understanding and diagnosis of HIV/STDs will enable appropriate contraceptive advice to be given, reducing risks to reproductive health (Finger 1994). Many countries in Africa currently have poor quality counselling and information/education services associated with FP/MCH services (Kim et al 1997; Hanson et al 1997).

Stigmatisation and wider populations

Stigma may be attached to using HIV/STD services which are often perceived as dealing with 'immoral' sections of society. Objections to providing STD services for this reason have also been reported by family planning providers in Asia (Finger and Barnett 1994). Women attending STD clinics in Nairobi felt they were stigmatised and treated badly and preferred to receive STD counselling and treatment from family planning clinics (Finger and Barnett 1994). Family planning services are often more accessible to women and do not have the stigma associated with STD clinics (Schneider 1994). For the same reason there are fears that family planning services will become stigmatised if HIV/STD programmes are integrated. One of the few reviews of integrated programmes however, found that only two of fourteen programmes examined considered stigmatisation as a problem. The others regarded integration as having a positive effect on client perception and utilisation (Walsh and Pollock 1995). An integrated service approach would thus appear to make it easier to treat groups at risk from STD infection who may not otherwise seek care, particularly women for whom attendance at MCH/FP clinics may be their only point of contact with the health service (Cates and Stone 1992a).

Stigmatisation can also be age related. While integrated facilities may work well for older women, unmarried adolescents may feel unwelcome or embarrassed and make little use of the services. Younger people are biologically and socially most susceptible to STD/HIV infection, yet they are often hardest to reach (Cates and Stone 1992a; Grosskurth et al 1995; AIDS Captions 1996; Zabin and Kiragu 1998). Adolescents (especially female) are also particularly susceptible to sexual violence and coercive sexual encounters and often have multiple partners; there is therefore a great need for sexual health interventions (Mnyika et al 1997; Wood et al 1998). Primary prevention is particularly important for adolescents and health education, through peer groups or school health initiatives may be important interventions (Kasule et al 1997; Rusakaniko et al 1997; Mayuad et al 1998). Outreach activities, community involvement and low-threshold services (as currently employed by many family planning delivery systems) will be important if these age groups are to be influenced (Laga 1995). Confidentiality and privacy need to be ensured, if young people are to be encouraged to use services (Population Reports 1995; Lauglo 1996). Training of staff should include ways of dealing sensitively with patients over private matters. One of the commonly cited criticisms by clients of both family planning and STD services is the rude or humiliating attitude of staff (Population Reports 1995; Field 1996).

Similarly sex workers may not feel comfortable using (or see no need to use) integrated services. A private clinic in Uganda documents success in reaching these groups by using outreach strategies such as songs and plays (Mukaire 1995). Peer group education has been particularly effective among commercial sex workers in Kenya and among prostitutes and truck drivers in Malawi (Population Council 1994; Wynendaele 1995). In a number of programmes in Africa, community workers were actually better received when their family planning remits were widened to encompass STD/HIV services since communities felt they were now addressing their needs more comprehensively (Population Council 1995).

One of the most crucial issues integrated programmes need to address if they are to be successful, is how to reach men as well as women. While integrated MCH/STD services could serve women well, men are unlikely to want to utilise MCH/FP clinics. While the shortcomings of family planning programmes in their neglect of men (and therefore of the power structures which determine sexual behaviour) have been recognised for many years and attempts have been made to rectify this (Richters 1992; Chibwana 1993; Ezeh 1993; Edwards 1994; Population Reports 1994b; Carra et al 1997; Hollos and Larsen 1997), the issue has not been transferred to the debate over STD/FP integration and few programmes

provide reproductive health services for men. A crucial (and highly problematic) part of any STD control is to reach and treat the male contacts of infected women. There is little literature on strategies for encouraging male participation in, and reaching them through, integrated services, yet their inclusion is imperative for decreasing STD/HIV incidence (Mayuad et al 1998).

In Brazil and Colombia the main family planning organisations provide male family planning services (often in separate male areas of the family planning clinic) which have proved popular (Finger 1994; Tsui et al 1997:37). Similarly in Africa, where men have been included in family planning programmes, there has been considerable support (IPPF 1989; Kwansa 1989; Chibwana 1993; Hollos and Larsen 1997). If family planning clinics extend their remit to STD treatment, men should be included or referral systems established to other male services; current experiences, though limited, with involving men in family planning programmes indicate such strategies can be effective if properly organised and managed. Various strategies for involving men in integrated programmes have been suggested such as establishing an STD clinic as an annexe to the family planning clinic, as tried in San Salvador and Kenya, or having different hours and male providers to deal separately with men (Finger and Barnett 1994). Separate clinics could be established for men and women, though this has major cost implications, or STD clinics serving largely men could add family planning services, including male methods and counselling (De Lay 1994). While men infected with STDs can seek treatment from existing types of STD services, it is to safeguard the reproductive health of their female partners that they need to be included in integrated strategies. With careful planning, integrated programmes could have great potential for encouraging male contraceptive use and helping to address the sexual power structures which often subjugate women. In eastern and southern Africa, high risk male groups (truck drivers; factory workers) have been successfully targeted to increase condom use and utilisation of STD services provided near the workplace (Ngugi et al 1996; Jackson et al 1997).

2.4 THE GHANAIAN CONTEXT

As in the international community, MCH/FP and STD/HIV services in Ghana have received very differential treatment from national policy makers. MCH services form a major part of primary health care in Ghana and receive considerable funding from government and donors. Family Planning has long been on the policy agenda of successive Ghanaian governments although it never received priority status and historical complexities in co-ordination and

responsibility often led to conflict, fragmentation and neglect, with sometimes ambiguous government policies (GoG 1991). By contrast, STD control programmes have only really developed in the 1990s and still have considerable bias towards AIDS. The MCH/FP and STD/HIV programmes are both logistically and physically separated. The AIDS/STD control programmes are located in the Disease Control Unit of the MoH under Epidemiology/Communicable Diseases Division at Korle-Bu Hospital, Accra. The MCH/FP Unit is located at the main Ministry buildings on a different site.

2.4.1 Development and Current Status of STD/FP Services.

Family Planning

Ghana was one of the first African countries to formulate a comprehensive population/family planning policy. Drawn up in 1969, the policy was advanced for its time, recognising the two-way relationship between population growth and socio-economic development five years before it was outlined at the Bucharest Population conference. The Government of Ghana (GoG) regarded population policy as a dynamic process, seeing it in a wider developmental context, and tried to address some of the broader issues of health and inequity which are in vogue today. During the 1970s-80s the emphasis changed from promoting technical and organisational change as the mechanisms for population control, to greater emphasis on direct demographic interventions (Pellow 1994; Kumekpor and Batse 1991). In 1970 the National Family Planning Programme (NFPP) and NFPP Secretariat were established, the latter located in the Ministry of Finance and Economic Planning and Development. The NFPP has now been superseded by the National Council on Population as the co-ordinating body which has independent parastatal status. Family planning services are provided predominantly by the Ministry of Health, the Planned Parenthood Association of Ghana (PPAG), and some other NGOs and church organisations (Owusu and Batse 1991). This very complex set has often led to ambiguity and fragmentation of FP funding and government policy (GoG 1991).

By 1979 a national policy on Primary Health Care (PHC) had been developed and was being implemented. This involved the expansion of MCH facilities, and during the 1980s family planning was integrated as a cost effective means of providing widely available FP programmes under the governments revitalisation policies (Cassels and Janovsky 1992). Access to contraception and family planning advice is not limited, although emphasis is on entirely voluntary fertility control and advertising is far from vociferous (personal observation 1995). Even twenty years after the implementation of Ghana's Population FP

policy, the Contraceptive Prevalence Rate (CPR) stood at just 13%, with only 5% of married women using a modern method (Ghana Demographic and Health Survey (GDHS) 1988) and Ghana was widely cited as an example of a failed FP programme. Researchers were puzzled by such a low take up, despite an apparently committed policy regime and a relatively high level of contraceptive knowledge (79.4% all married women knew of at least one method, GDHS 1988). Some commentators attribute the causes to flawed implementation and weak political commitment, others emphasise the weak climate for demand for services (GoG 1991; Owusu and Baste 1991; Binka et al 1994). All parties agree that the results of the programme have been disappointing.

In 1989 a National Conference was held on the Population Policy. The conference report details the most frequently cited problems faced by the family planning programme, in particular: the fragmented nature of population and health care policies resulting in conflict between the different implementing agencies; lack of political commitment to the policy given by past governments; poor co-ordination, and a neglect of men and rural communities. During the late 1980s the family planning programme was revitalised and the whole health care system has been restructured. The provision of family planning services was integrated within the nation-wide PHC programme. In 1986 the Population Impact Programme (PIP) was established as an outreach programme to inform and educate; the Ghana Social Marketing Programme (GSMP) was set up in the same year to expand and decentralise contraceptive distribution; The National Council on Women and Development was formed during the 1980s to promote co-ordination of women's development activities including family planning, particularly in the rural communities (Owusu and Batse 1991). In addition to considerable support for family planning programmes from donors, especially USAID and UNFPA, NGO financial and operational support for family planning increased. The Planned Parenthood Association of Ghana (PPAG) provide specialist family planning clinics focused mainly in the south of the country. Churches have been involved in providing family planning and marital/family life services since the 1960s and the Christian Council of Ghana supports family planning in poorly served areas.

Qualitative research has become more prominent in attempts to understand and explain behavioural patterns in the total socio-cultural, economic and political context of peoples' lives. The government commissioned a series of focus group studies to assess community opinion about the existing programme and consultative advice on how services should be changed (GMoH 1992b). Attempts to provide family planning through clinics or through contraceptive distribution strategies (particularly Ghana's contraceptive social marketing

programme) have not proved greatly effective; results from the focus groups suggested a more comprehensive approach to family planning service delivery is needed which links primary health care with community organisation and participation²¹ (Binka et al 1994). In the wake of this the Navrongo community health and FP programme was established in the Upper East region. It is a pilot project attempting to change current technology/facility orientated community health initiatives to a more community-orientated approach (Navrongo Health Research centre, 1994; Nazzar et al 1995). The Navrongo Health Research Centre has produced many research documents, a number published internationally. It is primarily funded by external organisations²².

The 1993 GDHS showed a marked increase in just five years to 20% of married women using contraception (14% a modern method) and 34% of married men using contraception (20% a modern method) with 10% using the condom making it the most popular method²³. It is possible that the vigorous government AIDS awareness campaign of the past few years has contributed to this rise, together with the increasingly endorsed concept of FP as part of wider reproductive health services. An evaluation of the response to a public education campaign against AIDS found that 39% of men and 5% of women interviewed admitted to changing their sexual habits because of AIDS, either by reducing the number of sexual partners or by using condoms (Neequaye et al 1991a). Another possible explanation could be the relative political stability of the last decade. Former, problems of changing regimes brought disruption in commitment, administration, implementation and management of the family planning programme.

STDs

By contrast, STDs were barely acknowledged as a public health problem until the 1980s when the first AIDS cases sparked concern and investigation into HIV and associated STD prevalence rates. No comprehensive STD control programme existed before the 1990s, and even the 1994 MoH Annual report on the AIDS/STD control programme concentrates heavily on AIDS surveillance and prevention and contains no data on STD prevalence. STDs have been relatively common in Ghana for centuries (Pellow 1994), but were not perceived as high priority. During the colonial era, venereal disease (VD) spread rapidly inland, and

²¹ These were the broad-based concepts later echoed at the Cairo and Beijing conferences.

²² It was set up by DFID for an extensive Vitamin A trials programme in the 1980s but is now primarily funded by the Population Council with additional support from Rockefeller, Ford Foundation and others, with a focus on FP provision in rural communities.

²³ The other 10% men citing a modern method are predominantly accounted for by their female partner's use of a method (the pill was the highest at 4.7%) and not their own use of other male contraceptives.

gonorrhoea was known to be widespread in the major towns by World War I. By the mid-1940s it was reported that the Gold Coast troops had a 50% VD rate, gonorrhoea being the most common (Pellow 1994). Far more males than females were treated, partly due to care provided for soldiers and male prisoners, and partly because many women are asymptomatic.

The National AIDS/STD Control Programme annual reports rarely include data on STD incidence and current, accurate data is practically unobtainable; national sentinel surveillance has been concentrated on HIV/AIDS. A recent study puts the incidence of STDs in Accra and Kumasi at c.1% of the total adult population, with the most problematic diseases being gonorrhoea, chlamydia and trichomoniasis (Pellow 1994). This is likely to be an underestimate since preliminary results of a 1992 surveillance programme in these cities suggested STDs were being substantially underreported (GMoH 1993b). HIV and AIDS surveillance shows a steady increase since 1986 and in 1995 2-4% the adult population was estimated as carrying the virus (of which 75% infections were the HIV-1 type) (Dodd 1995; MoH 1996b). The cumulative total of reported AIDS cases stands at just under 2.1 million (MoH 1997). In 1996 (the last full year for which data is available), 3295 cases were reported with two regions (Ashanti and Greater Accra) accounting for more than 45% cases and three other regions (Eastern, Brong Ahafo and the rural Upper East) accounting for a further 34% (MoH 1997). Parts of Eastern and Ashanti regions have recorded HIV rates as high as 18% among pregnant women, although these data may be attributed to large numbers of false positives (MoH 1996b). Southern regions record higher levels HIV incidence partly because they are centres of prostitution and economic development, and partly because the surveillance systems there are the best developed (Dodd 1995). A recent sample of Accra prostitutes found 15% were HIV positive (Neequaye et al 1991a). Pockets of high levels of HIV in rural areas (particularly border-lands) can be explained by migratory prostitutes who return to Ghana from neighbouring countries like Cote d'Ivoire, Benin and Mali when they become sick (Anarfi 1993; Decosas 1993; Peeters et al 1998). Tables 2.1 and 2.2 give some comparative figures for STD and HIV prevalence in Ghana and other selected African countries.

Table 2.1 Comparative STD statistics for Selected African Countries

Country	STD Incidence and study population	Year and Source
Ghana	1% any STD in general urban population	Pellow 1994
	2% general adult population (likely to be a significant underestimate)	USAID 1994b
Burkina Faso	2.5% Syphilis in urban ANC attenders	Sangare et al 1997
	52.6% any STD in urban prostitutes	Lankoande et al 1998
	32.4% any STD in urban ANC clients:	Meda et al 1997
	14% trichomoniasis 13% bacterial vaginosis 3.6% recent syphilis 3.1% chlamydia 1.6% gonorrhoea	
Cote d'Ivoire	5.5% chlamydia 3.7% gonorrhoea in urban ANC attenders, (Abidjan)	Diallo et al 1997
Benin	39.8% gonorrhoea or chlamydia in prostitutes	Germain et al 1997
Kenya	53.8% any vaginal infection (20.6% bacterial vaginosis; 19.9% trichomoniasis) and 10.8% gonorrhoea/ chlamydia infection in urban ANC attenders (Nairobi)	Thomas et al 1996
	3.2% gonorrhoea, 5.2% trichomoniasis 1.9% syphilis 1.9% genital ulcers in urban FP attenders (Nairobi)	Daly et al 1994
Tanzania	22.7% trichomoniasis 4% syphilis 3.6% gonorrhoea in urban ANC attenders (Dar es Salam)	Mwakagile et al 1996
Zambia	20% any STDs urban ANC attenders (Lusaka)	NACP 1996

Table 2.2 Comparative HIV statistics for Selected African Countries

Country	HIV+ Incidence and study population	Year and Source
Ghana	4% total adult population	Unicef 1997
	8% STD clinic attenders	National STD Clinic, 1996
	1.6-3.6% ANC attenders	1995 HIV Sentinel Surveillance, MoH 1996
	15% urban prostitutes (Accra)	Neequaye et al 1991
Burkina Faso	8% urban ANC attenders	Sangare et al 1997
	58.2% urban prostitutes	Lankoande et al 1998
Cote d'Ivoire	16.2% urban ANC attenders (Abidjan)	Diallo et al 1997
Kenya	7% total adult population	NACP 1996
Zimbabwe	64% rural STD clinic attenders	Le Bacq et al 1993
Tanzania	15.2% urban ANC attenders (Dar es Salam)	Mwakagile et al 1996
Zambia	17.1 total adult population	WHO-GPA 1995

The last available MoH annual report (1994) indicates that AIDS and other STDs account for 0.4% of all communicable disease incidences, but the more important figures to note are those for pregnancy related complications (3.6%), gynaecological disorders (1.2%), acute eye infection (5.3%) and other urinary tract infections (2.3%), the first three of which have consistently appeared among the top ten ranking diseases in Ghana over the past few years (GMOH reports for 1991-1994). Each of these complaints can arise as a result of untreated STD infection (GMOH 1993b). Given the substantial underreporting of STD infection (GMOH 1992b), together with the poor quality of management and the difficulty of diagnosis (particularly of asymptomatic women), it would be reasonable to assume that proper control of STDs could have a significant impact on several other leading causes of morbidity and mortality in Ghana. The figures for maternal mortality substantiate this point. The 1993 MCH/FP report indicates a gradual rise in institutional maternal mortality rates during the 1990s, standing at 2.8/1000 live births in 1993. UNICEF put Ghana's maternal mortality rate in 1992 as the fourth highest in the world (UNICEF 1992). The reasons for this are unknown. The MoH suggests it could be due to improved reporting by traditional birth attendants (TBAs) and more efficient recording systems, though these are unlikely; illegal abortions certainly contribute to the high rates. Another explanation however, could be that HIV/STDs are playing a significant role in complicating pregnancy. Sero-surveillance surveys

conducted by the MoH, indicate that HIV prevalence in pregnant women is on the increase, ranging from 2% to as high as 18% in one part of the Eastern region (GMoH 1992b; Decosas 1995; GMoH 1997). It may not be coincidence that the Eastern region has both the highest HIV incidence, and also the highest (and increasing) low birth weight figures (GMoH 1994a, 1995a).

STD care and management have historically been very poor (Pellow 1994). Even in the 1970s, no special VD clinics existed and 70% patients were treated by 'dispensers' and non-medical personnel. This situation probably still exists. In 1995 a study found that Ghana's poor preferred to use drug sellers than public health facilities which were perceived as poor quality and badly stocked (Korboe 1995). There is little regulation of private sector pharmacies which operate quite separately from the public sector (Korboe 1995); they have extensive coverage and are likely to be preferred, if patients can afford them, because they are more anonymous.

In 1985 it was found that many of the Ghanaians expelled from Nigeria were suffering from STDs. They were quarantined and Adabraka Polyclinic was established, in Accra, to care for them under the Communicable Disease Control of Greater Accra Regional Health Administration (Pellow 1994). Since 1991 (when a resident Dr was appointed) the clinic has assumed responsibility for the Regional AIDS control programme, and screens all patients for HIV (Pellow 1994). It now acts as a referral clinic as well as caring for those who come without being referred. In 1992 a second government STD clinic was established at Komfo Anokye teaching hospital, Kumasi, following the successful training of a medical officer in STD control in the UK during 1991 (GMoH, 1993b). Two or three specialist private clinics also exist in the southern and middle regions.

Practitioners in Ghana believe STDs are common (Pellow 1994; personal communications 1995-8) and reports of the MoH AIDS/STD control programme indicate a high incidence of STDs since 1986 (MoH 1993b, 1995b, 1996b, 1997), though the government's emphasis has been very much on AIDS prevention (GMoH Annual Reports). In 1985 a National Technical Committee on AIDS (NTCA) was established to assess the situation and advise the government on prevention and control (Asamoah-Odei et al 1990). In 1989 a five year programme was drawn up by the ministry of health and the NTCA in collaboration with WHO's Global Programme on AIDS to prevent further transmission and spread. This attracted Western funding and the EEC funded STD control as part of the programme. WHO recognises the importance of addressing the question of STD prevention in tandem with the

AIDS programme, and collaborating donor agencies are also funding STD prevention and control programmes. In 1993 the MoH formally brought together the AIDS and STD control programmes, though the National AIDS Programme still seems to retain an independent identity and receives 80% its funds from external donors (including WHO, USAID, UNICEF and GTZ) (GMOH 1993b, 1997; Dodd 1995). The aim of the combined programme is to reduce morbidity of STDs as co-factors in HIV transmission and to reduce complications associated with STDs (GMOH 1993c).

The importance of counselling and public education about safe sex, as well as diagnostic services, is recognised and a number of Ghanaian authors, often based at universities have written on the cultural dominance of men in sexual decision making and socio-cultural practices may promote STD/HIV spread (Asamoah-Odei et al 1990; Neequaye et al 1991b; Ankomah 1992; Awusabo-Asare et al 1993; Ezeh 1993). The coverage and quality of these preventive services is, however, unknown. The most recent Demographic Health Survey suggests that the government AIDS education campaign, begun in 1986, appears to have had some impact. The survey indicates high general knowledge about how the infection is acquired (90% adults) and even some recorded behaviour change as a result (GDHS 1994). Media, especially radio programmes in local languages, played an important role (Neequaye et al 1991a). Although the National AIDS Programme fares better than STD control, it too has been criticised, both internationally and internally, for lack of high level commitment (Dodd 1995). The first plan of action expired in 1993, yet the second medium-term plan has only recently been finalised while ministries wrangled over what their contributions should be (Dodd 1995; Interviews 1996-7).

Services dealing with HIV take precedence over STD components and as a result, surveillance for STDs is very low. Official forms for monitoring STD consultation have so far only been introduced in Accra and Kumasi (GMOH 1992b). By 1992 the Health Education Division of the MoH's Epidemiology Office had joined forces with a private advertising company to produce a publicity leaflet on STDs. The extent of distribution of the leaflet is unknown however, and STD awareness and publicity is far lower than for AIDS (unpublished PPAG survey 1995; personal observation 1995-7).

Ghana represents a particularly pertinent choice for a case study on reproductive health policy for reasons given in the preceding chapter (section 1.5.2). Essentially, there is considerable interest in reproductive health in Ghana, although as yet operational strategies are limited, and their FP/MCH services have been long established and are considered to

have good coverage nation-wide. Given the relatively stable political and economic base in Ghana at the present time, the country can be regarded to some extent as a 'golden standard' for the integrated reproductive health strategies so widely espoused by the donor community. If the problems prove too great to be overcome in Ghana, perhaps there should be serious misgivings about the feasibility of integrating these services in other sub-Saharan countries.

2.5 LIMITATIONS IN CURRENT LITERATURE AND RESEARCH AND THE IMPORTANCE OF THIS STUDY

This review of the literature on 'integrated reproductive health' services points to two major lacunae: one the lack of in-depth case studies and two, the lack of clarity on what constitutes an integrated reproductive health service/policy.

2.5.1 The lack of case studies

Documented case studies of integrated reproductive health services, are very limited and many merely provide operational description. A number of substantive studies are being planned, but currently there is little completed documentation available beyond 1995. An operations research paper by the Population Council in Nairobi provides a notable exception for East and Southern African case studies (Maggwa and Askew 1997); there are none such for West Africa. Family Health International is in the process of drawing together case studies of post-Cairo implementation of 'reproductive health' services but these are not yet available (FHI 1998). The Africa Region Population Council is organising a workshop in December 1998 to discuss implementation case studies, and their implications for future research and policy directions. The Population Council has also analysed the Situation Analysis data from five sub-Saharan African countries with regard to integrated reproductive health (Population Council monograph, 1998). The case study provided in this thesis will be a contribution to the expanding information base on implementing integrated reproductive health services.

To date, a number of case studies document integrating STD/HIV services with family planning programmes (Bastos dos Santos et al 1992; Population Reports 1993; Finger and Barnett 1994; Mukaire 1995; Twahir 1995). Some programmes are able to treat selected STDs on site (Bastos dos Santos et al 1992; Population Reports 1993; Finger and Barnett 1994; Twahir 1995) though Zimbabwe is probably the only example of nation-wide public-

sector integration (Grosskurth et al 1993, 1995). Many donors are supporting STD integration with family planning (UNFPA 1991, 1995, WHO/HRP 1992-3; World Bank 1993, 1994). Some case studies cover integration more broadly (as envisaged at the Cairo conference) into primary health care (Bastos dos Santos et al 1992; Population Reports 1993; Pathfinder International/Population Council 1995; Mukaire 1995; Twahir 1995). Public and private sectors and urban and rural case studies are covered.

The most complete documentation of integrated case studies in Sub-Saharan Africa comes from a conference hosted by the Population Council in 1994 (*Setting the African Agenda 1995*) to which a sequel is planned for 1998 (personal communication, Population Council 1998). Objectives and strategies used by the different programmes presented here vary, but a number of basic components were present in most and recurrent problems can be identified. IEC, counselling, risk assessment and referral of clients where necessary to better equipped facilities, were successfully integrated by all the programmes. Basic diagnosis and treatment was undertaken at various levels using the syndromic approach with reputed success (although elsewhere there is considerable doubt over the efficacy of syndromic guidelines - see section 2.2.2 above). Testing for HIV, with care to prevent cross infections, was carried out by the larger clinics, the others referring to better equipped facilities. Screening of antenatal clients for syphilis was provided at most clinics.

An inventory compiled by Pathfinder International (PI) together with the Population Council of examples of integration of STD/HIV services with family planning, records 65% of those surveyed so far as providing a combination of clinic, community based distribution (CBD) and/or other outreach facilities (Population Council 1995b). IEC/counselling was found to be very successful at community level, particularly for reaching groups who may not attend the clinics. It was less successful in a clinic setting, largely because of overworked staff and negative attitudes (Population Council 1995b). Other problems documented include: poor staff training, inadequate referral networks and drug procurement and delivery networks, cost (to the client) of STD drugs and difficulties of tracing partners for treatment. In general integrated services seem to be considered successful by medical staff and are well utilised by clients.

2.5.2 Lack of clarity over definitions of 'integrated reproductive health'

Despite consensus over the need to integrate reproductive health services, universal definitions as to what those services should constitute are lacking, and different stakeholders

inevitably have different motives, priorities and concerns. The key questions researchers and policy makers must now address are what constellation of services is feasible at what levels and under what circumstances. The existing literature and case study documentation suggest that some aspects of STD/HIV services are better suited to integration with MCH/FP than others. A Donor workshop set up in the wake of ICPD has tried to define a number of essential elements, and different organisations are beginning to develop operational strategies (Lauglo 1996).

At the implementation level, programme activities for reproductive health services might ideally include FP, MCH, treating the consequences of unsafe abortion, prevention and control of STDs including HIV, full counselling, infertility treatment, pap smears and general gynaecology and urology services. Such high level integration is probably only feasible at District/Regional level hospitals, with lower level facilities integrating preventive strategies and some basic diagnostic and treatment services. National policy makers need to determine what elements can realistically be integrated within programmes of varying organisational capacity without compromising their effectiveness (Pachauri 1994; Sai 1995).

Successful programmes need to be dependent on local STD epidemiology²⁴, organisational, financial and resource bases and capacities, and the socio-cultural values of the country. These criteria warrant a spectrum of different levels of integration, perhaps involving a symbiosis of vertical and horizontal approaches (Pachauri 1994; Hellberg 1995; Potts 1995; Bradley 1998).

There is a notable dearth of models for integration which could structure research and inform the design of strategies for integrating FP/STD services. Most typologies (such as the integrated and vertical, independent health infrastructures identified by Smith and Bryant, 1988) relate to general PHC services. While a number of models exist for analysing specific aspects of reproductive health²⁵, no research has systematically developed models or criteria to guide policy makers and programme managers on how and at what level reproductive health services could and should be integrated. In depth, country-specific studies are needed to provide an analysis of the political, economic and socio-cultural contexts of programme

²⁴ This is a critical factor for decision makers with implications for strategy preferences and drug choices, yet little epidemiological research exists, certainly not at a local level, in much of the developing world. This adds weight to the rationale for decentralisation which could more effectively address local needs and capacities.

²⁵ For example Bulatao's and the Evaluation project's indicators for FP programmes and Bruce and Jain's quality of care model (Bruce 1990; Bruce and Jain 1991; The Evaluation Project 1993; Bulatao 1995; Lauglo 1996)

development and implementation, the health sector resource base, and local clinical and programmatic issues of STD/HIV and FP/MCH services. These would generate essential guidelines for decision makers on how to approach integration and under what circumstances it is feasible and appropriate for given communities. The policy analysis approach of this research offers an opportunity to assess the practical realities of reproductive health policy implementation which will inform future policy decisions with regard to these questions.

2.5.3 Research limitations and the importance of this research

In sum, the literature surveyed points to a number of gaps in current research on reproductive health, most importantly:

- Reproductive health discourse has a generally clinical focus to the neglect of public health issues and of anthropological-sociological research considerations which include social and gender relationships and concepts of power.
- There is a dearth of holistic, country-specific case studies on reproductive health policies, strategy development and service delivery which could inform definitions of 'integrated reproductive health services'.
- A policy approach has not been applied to reproductive health and analysis of the interaction between macro and micro dimensions of this subject has been neglected.

Researchers, international agencies and policy makers have often been blinkered, focusing on specific issues around family planning or STD/HIV giving priority to clinical concerns and often divorcing services from the socio-cultural, behavioural context of sexual relations, by working within a narrow model of medically-orientated health care. This model is driven by the clinical nature of STD curative treatment and the financial implications of service provision (largely clinical) at the expense of preventive strategies and cultural, moral and ethical considerations. The deficiency in cost-related data on integration of reproductive health services has been acknowledged, but in terms of programme 'success', it is more important to be cognisant that STDs are social as well as medical diseases and if management strategies are to be effective, they must understand and address the social aspects as well as the medical.

Theories abound on what factors influence human sexual behaviour²⁶. Recognition of the importance of gender relations for women's health is growing, particularly in its relation to reproductive behaviour²⁷ (see for example Safilios-Rothschild 1985; Oppong 1987). There is also a dearth of qualitative research particularly in the family planning and reproductive health arena, where much empirical research has been quantitative, not allowing for insight into the meanings which guide behaviour so that 'procreation is isolated from gender roles and sexual behaviour' (Richters 1992:747); and child and reproductive health programmes and development initiatives in general have been insensitive to the reality of women's daily lives and do not therefore address their needs (Giorgis 1985; Lane and Meleis 1991; Lane 1992; Prevention of Maternal Mortality 1992; Mosse 1993; Turner 1995).

While the importance of public health strategies and the need to address stigma and to reach men have all been recognised, the response has generally been to change *clinical* services to address them. While there is a prolific literature on social-cultural and family influences on sexual decision making and the impact on uptake of family planning and on fertility decline, this reflects the research and programme bias of the international community towards family planning over other components of reproductive health programmes. Family planning itself has typically been provided through clinical structures or vertical outreach programmes.

Similarly, concern over AIDS has generated considerable writings on the need to understand what motivates sexual behaviour, and what determines constructs of male and female identities and sexual 'norms'. These have tended to fuel western-driven policies and programme decisions which are often isolated and vertical in conception.

As the paradigms for reproductive health change, the bio-medical and vertical focus is now slowly being redressed (Potts 1995; Post Cairo Working Group 1995). The convergence of rationales from all parties is encouraging consensus on integrating reproductive health services. It is also forcing a broader conceptual framework, compelling analysis of integration issues to be sensitive to the wider multi-sectoral dimensions of reproductive health service provision, particularly the empowerment of women and addressing the gendered power structures which dictate sexual decision making and health seeking behaviour (Dixon-Mueller 1993; Ankrah and Henry 1994). The key question is have these

²⁶ These range from economic (for example, Easterlin 1983; Freedman 1987) to socio-cultural (Caldwell 1983; Freedman 1987; Cleland and Wilson 1987) explanations.

²⁷ In response to severe criticism of family planning programmes for not addressing men and gender issues, prolific research was generated in the 1980s on male involvement in family planning and the role of conjugal communication in sexual matters. see for example Kwansa 1989; Oppong 1989; Richters 1992; Chibwana 1993; Ngom 1997.

increasingly sympathetic international ideologies been mirrored in new reproductive health services and programmes?

Perhaps in recognition of this question, and the need to understand the implications of widespread health sector reforms, more attention is being given to the policy dimensions of health care provision (Walt 1994, 1995; Walt and Gilson 1994; Foltz 1995; Barker 1996). Policy aspects and implications of STD/HIV and FP/MCH integration are only beginning to be systematically researched; there have been few comprehensive analyses of the different stakeholders now involved in reproductive health (including the often subjugated service providers and the clients themselves) and their relative influences (financial, material, bureaucratic, moral etc.) on policy and service provision. Given the necessarily multi-sectoral dimensions of reproductive health, a policy analysis approach provides a particularly appropriate framework for analysing and understanding the complex, multi-faceted issues, and synthesising the claims and concerns of the diverse parties involved. Clarifying these aspects is essential to understanding current programmes, informing potential policy directions and articulating reproductive health goals in operational terms. If reproductive health as stated in terms of the wider context consolidated at the Cairo Population Conference and the UN Conference on Women in Beijing is to be realised, the issues must be analysed in a more country-specific and multi-dimensional context hitherto lacking.

The present research is one contribution to understanding the nature of policy and of power, the interaction of the state and its machinery with individuals at all levels, the tensions between public and private choices and responsibilities, public health and clinical health care. Applying a policy analysis approach enables a synthesis of macro and micro dimensions, from national policy directives to what reproductive health means for village women. By providing a country-specific case study, this research helps to fill some of the research gaps identified and contributes to the debate on how to make reproductive health a reality.

CHAPTER THREE

THE REALITY OF STD MANAGEMENT WITHIN MCH/FP: THE UPPER EAST REGION

*'Government interventions have forgotten the reality on the ground'
Senior Ministry of Finance official 1996*

*'We critically need to know the terrain and the people. We think we know our own people
then we find something out about them and realise we hadn't understood them at all.'
Senior Ministry of Finance official 1996*

Health services at the district and sub-district level represent the critical part of the policy process which is often neglected at national levels: implementation. The hypothesis of this chapter is that there are a variety of contextual factors influencing implementation of STD strategies (clinical-technical; systems-management and social-behavioural). It is argued that each of these clusters of factors is important although the 'social-behaviour' group has been most neglected. Understanding is needed of both the terrain and the people. While clinical-technical and systems-management factors illustrate the 'hard' elements of context, the social-behaviour factors reveal how and why *people* (who are the cast in this play of implementation) act as they do. It is together that these factors illustrate reality and can most effectively inform policy.

The first part of this chapter introduces the Upper East Region and its six districts followed by details of their clinic service structures and the facilities visited. The main body of the chapter provides a systematic analysis covering each aspect of national policy statements on STD management within MCH/FP, first clinical then public health, drawing out the main constraining factors for each. The final discussion brings out the main points and presents the different influences on implementation. Some assessment is made of the relative influence of the different factors on implementation and their links with national and regional level issues are indicated.

3.1 A PORTRAIT OF THE UPPER EAST REGION

3.1.1 Realities of Place: Upper East Region, its districts and health profile

The Upper East Region (UER) is one of Ghana's most remote, some 400 miles from the capital, Accra. Recently improved road access has cut journey time from Accra to

Bolgatanga, the regional capital, to 11 hours on government transport instead of over 15. Even Tamale, the Northern region capital 100 miles to the south of Bolgatanga, and 300 miles from Accra, feels like another country. One young man having just returned from Tamale remarked 'I've been to places I never thought I'd see - I've been to the south!' Burkina Faso, formerly Upper Volta, borders the Upper East Region to the north and another Franco-phone country, Togo, borders it to the east. Local languages cross the political boundaries with ease as do families and even identities. The feeling that successive governments have neglected the people of the far northern territories is widespread, creating ambiguous identities. On a number of occasions people told me 'we are not Ghanaians, we are Upper Volta people'. The isolation is felt by aid workers too. A Ghanaian Action Aid programme officer said 'here you feel out of this world' (Interview 1996). There are few urban privileges and poor communications. The regional capital, the main border town, Bawku and one or two other small towns have electricity and telephones. For the rest, chores must be finished before dusk falls at 6-7pm, then social contact must take place by the light of the moon or kerosene lamps for those who can afford them. Figure 3.1 below shows where the Upper East Region is located in the map of Ghana indicating its remoteness from the capital Accra in the south.

Figure 3.1 Upper East Region in relation to Accra

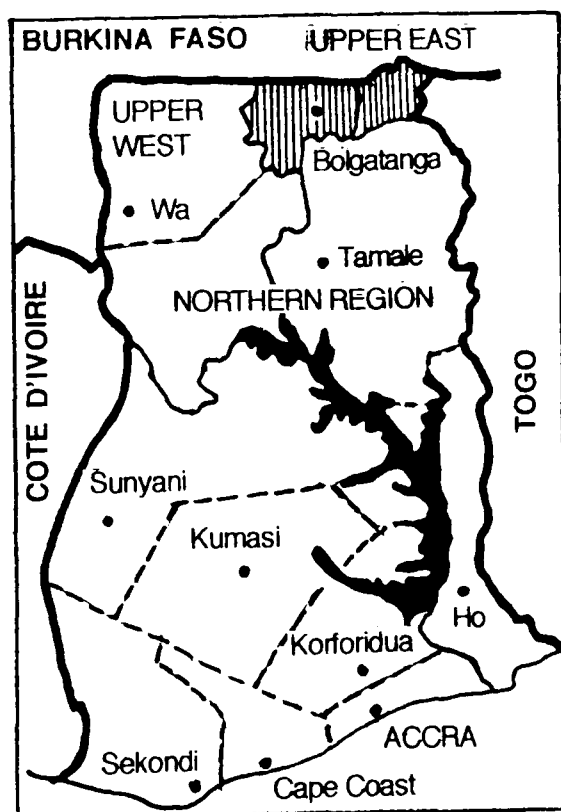

With remoteness and political neglect, comes poverty. The people of the Upper East are some of the poorest in Ghana. With a population of a little over one million, the Upper East represents 6.3% of Ghana's total population. Eighty seven percent (87%) of this population is rural, relying on capricious rains between May and September for their staple harvests of millet. A sack of millet will only provide staple meals to last a family of 6 or 7 for about 15 days (personal communications 1996-7). For most of the year the savannah is dry and tawny, undulating for miles, broken by rocky outcrops and distant hill ranges. Occasional oases of green coloured by a deep water hole, and the odd, tiny mud-ridged vegetable garden, bear testimony to the human struggle as farmers eek out a living from the unproductive soil. Scattered dams, a legacy of the Nkrumah²⁸ era, offer the prospect of irrigation, but in the wake of land-use disputes and ambiguous power-hierarchies many have fallen into disrepair. Before rains bring relief, severe dust and heat are heightened with the onset of the Harmattan²⁹. These winds first bring night temperatures to a low of 12-18C, during the day heat steadily increases reaching 45C until the rains fall.

Belief systems are very traditional, even though there are significant numbers of both Christians and Muslims in the region, and some types of sickness are still commonly held to be caused by witchcraft or 'juju'. The disease epidemiology of the region is typically pre-transitional³⁰. Child mortality is high and maternal mortality is the highest in Ghana; people are strongly pro-natalist and contraceptive use is practically non-existent. The burden of STDs and AIDS is largely unknown, but there is NGO concern in the border towns where clinics report much higher incidences of STDs and HIV than elsewhere in the region. Table 3.1 and Figure 3.2 below compare national statistics on AIDS and other reproductive health indicators with those for the Upper East.

²⁸ Nkrumah, the first president of independent Ghana, implemented a widespread dam scheme in the 1960s with World Bank/IMF funding as part of his social and rural development programme.

²⁹ Severe trade winds from the deserts to the north-east, bringing thick dust between October and April each year.

³⁰ In classical disease epidemiology, three types of conditions are recognised: pre-transitional where diseases related to malnutrition, unsafe water, malaria etc. are the biggest causes of morbidity and mortality; 'transitional' where so-called 'industrialised' diseases start appearing; and 'post-transitional' where the biggest disease burden is from disease like cancer, heart disease and mental illnesses (see for example, Phillips 1990).

Table 3.1 Comparative statistics for Upper East Region and Ghana:
Incidence of AIDS; Maternal mortality rate; FP and ANC coverage

Indicator	Upper East Region	Ghana	Data Source
AIDS - Cumulative total - Cases as % of total national cases - HIV rate in general population	575 2.8% 2-4%	20 859 100% 2-4%	1996 AIDS surveillance report, National AIDS Control Programme
Maternal Mortality Rate	5%	2.4%	MoH Annual Report 1996
FP Coverage rate (women in fertile age group - WIFA)	9% Av. 1.2 visits/year	15%	MoH Annual Report 1995; Upper East Regional Report 1996
ANC Coverage rate	67.3% Av. 2.6 visits/pregnancy	87%	MoH Annual Report 1995; Upper East Regional Report 1996

Figure 3.2: Selected Reproductive Health Indicators as Percentage of all clinically recorded Communicable Disease Cases, National and Upper East Region 1995-6.

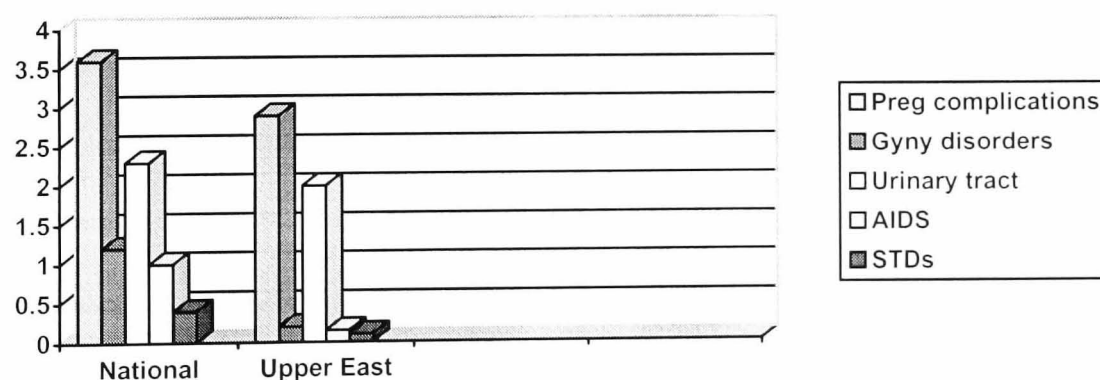

Source: MoH MCH Annual Report 1995; Upper East Region Annual Report 1996.

Family planning uptake is just 9% of women in the fertile age range, and the average figures for attendance per client of 1.2 per year suggest that many contraceptors are not consistent users (MoH(UER) 1997). Interestingly, pregnancy related complications and gynaecological disorders are lower as a percentage of clinically reported cases than the national average, yet maternal mortality (Table 3.1) is far higher. This discrepancy could be due to use of health care facilities only as a last resort, or not at all, resulting in low recording of problems until they result in death.

3.1.2 Health facilities and technical capacities

There are 6 districts in the Upper East Region, which vary in size and resources. Health facilities were visited in each district to a total of 27. Figure 3.3 shows the six districts of the Upper East Region with all the towns and villages where health facilities were surveyed. Bawku-West District which was the focus for chapters 4 and 5 is highlighted.

The 27 health facilities visited covered a range of levels and types. Facilities visited and numbers of staff interviewed by facility type are indicated in Table 3.2; numbers of facilities visited by district are shown in Table 3.3.

**Table 3.2 Health Facilities visited and Staff interviewed;
Total facilities and staff in Upper East, by facility type**

Type of health facility	Number of health facilities visited (as % of total facilities in UER)	Total number health facilities in UER*	Number of staff interviewed at facilities visited (as % of total number staff)	Total number medical staff at facilities visited
Hospital	4 (100%)	4	31 (5%)	611 (including those on secondment and outreach)
Health Centre	8 (40%)	20	33 (38%)	88
Private clinic	6 (75%)	8	10 (83%)	12
Mission clinic	3 (15%)	20	10 (46%)	21
MCH centre	3	4	6 (43%)	14
Community clinic	3 (27%)	11	3 (50%)	6
Private Laboratory	1	N/A	1 (50%)	2
Total	27 (c.35%)	c.77	94 (12.5%)	754

*These figures should not be considered exact. They are taken from 1995 regional annual report data although other sources give different figures. Not all categories can be extrapolated from official figures.

Figure 3.3 Upper East Region showing settlements where health facilities were surveyed

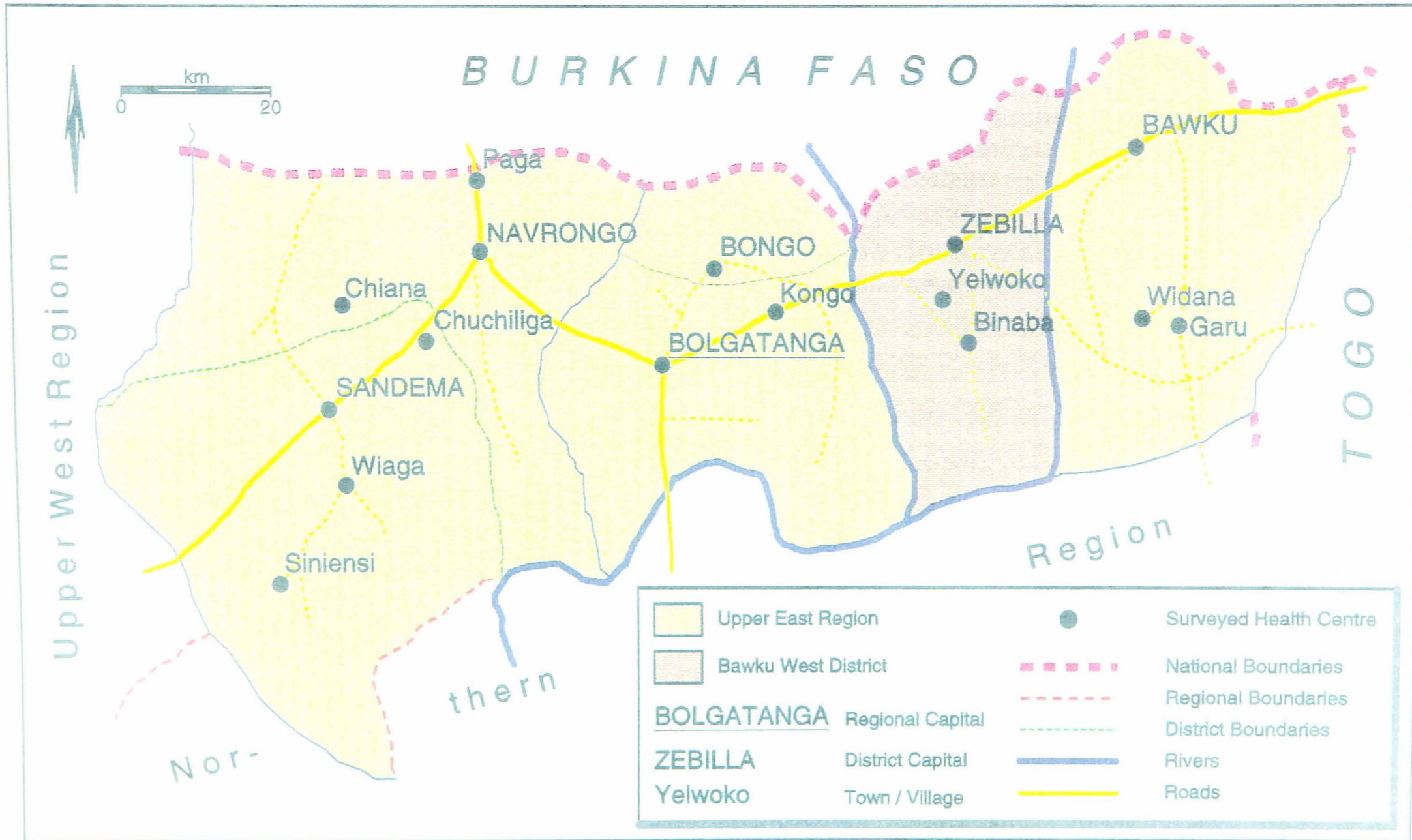

Mayhew 1998

Table 3.3 Number and percentage of facilities visited in each of the Six Districts of the Upper East Region

District	Number Facilities Visited (as % of total in the district)	Total number facilities in the District*
Bolgatanga (regional capital)	8 (40-67%)	12-19
Bongo	1 (25-50%)	2-4
Bawku East	6 (23-29%)	21-26
Bawku West	3 (50-30%)	6-10
Builsa	5 (71-83%)	6-7
Navrongo	4 (33-40%)	10-12

* Range of figures is taken from 1995 Regional MoH data-base print-out, Regional Health Management Team 1995 Annual Report and 1995 Regional Hospital Annual Report.

The 1995 Regional Annual Report lists 77 health facilities for the region, but notes that only 21 of these provide the basic primary health care package of clinical, public health and maternity services. Of the others, some provide exclusively MCH/FP services but most offer some limited curative care only excluding full MCH/FP services. On the basis of 21 facilities offering a full range of basic health care, the facility:population ratio is 1:51 500, compared with a national average of 1:9476 (GMOH 1996a). The doctor:population ratio stands at 1:54 075.

The Upper East Region does not have the full complement of medical staff recommended in the 1978 Primary Health Care policy (GMOH 1995a). It has 4% of the country's health institutions (for 6.4% the population) and the largest deficit of health services in any region requiring a further 42 facilities to meet the national average (GMOH 1996a). Sustaining adequate numbers of medical staff in the region is a major problem. Doctors in particular prefer to work in urban areas or overseas where salaries and living standards are much higher³¹.

The question of attracting and keeping people in the less favoured areas (through incentives or compulsory rotation) is being discussed at national level. A national initiative to move

³¹ The biggest selling national newspaper, *The Daily Graphic*, ran a headline on 4th February 1998 stating 'Doctors refuse postings to Upper West'. Fourteen medical Drs over a period of 4 years had refused to take up positions in the Upper West, the other northern region, because it is considered too underdeveloped and facilities too basic. They had instead opted for private practice or taken posts overseas. The problem is the same in the Upper East Region.

training schools to the regions was an attempt to address the problem. There are now Midwifery and Nursing training schools in Bolgatanga, but facilities are extremely limited. There is a community health nurse (CHN) school in Tamale, but the nearest medical assistants (MA) training is in Kintampo (some 300 miles from Bolgatanga and about 8 hours away on public transport). Doctors and public health nurses (PHNs) are trained only in Accra.

MCH/FP services constitute a major part of health services delivery in Ghana. These services are divided into 'Maternal' and 'Child Health' Services which are effectively organised separately (Rakodi 1996; personal observations 1995-7 and see chapter 7). The former covers ante-natal care (ANC), post-natal care (PNC) and family planning (FP); child health consists of immunisation, growth monitoring and nutrition. Even within maternal structures there are clinics for different services often arranged on different days³². Nurses for family planning may be quite separate from nurses for other maternity services, although a client coming on any day for a particular service will usually be treated (staff interviews and personal observations 1996-7).

A typical general clinic or health centre in the Upper East consists of a complex with various wings, or a compound with about three separate buildings each with its own staff. The main building or section is for the outpatients and includes consultation room(s) where the doctor or medical assistant is based, injection room, drug dispensary, clinical records and sometimes a lying-in ward and a small laboratory. Another building or wing is for ante-natal care and other maternal services, and may include a delivery ward, staffed by nurse midwives of various ranks. A third section is usually dedicated to family planning, child welfare and health education, staffed by public health and community health nurses. Clients typically wait on benches outside consultation rooms which are often screened with a curtain. There are usually a few posters on the walls, though staff complain that they get torn off by the wind and since most clients cannot read, they do not display them. Consultation rooms usually have some treatment flowcharts - predominantly for malaria, oral rehydration and infection control. Any medical cases, like STDs, seen at the maternity or family planning areas are usually referred to the Dr or MA in the outpatients department. MCH clinics within district hospitals have been re-located (sometimes, but not always, physically) to clinics in the sub-districts³³ (in the Upper East all four are still in the district capitals), with their own

³² Carrying out specialised activities on certain days was supposed to have stopped in 1994, but in practice facilities with a large workload usually still organised services this way.

³³ This was part of a national initiative funded by DFID to 'strengthen sub-district health systems'.

administrative systems. Few have drugs of their own, so STD and other medical cases are referred back to the hospitals.

Some selected characteristics of the 27 facilities visited in the Upper East are shown in Figure 3.4. Figure 3.5 indicates the availability of equipment at facilities nation-wide³⁴.

Figure 3.4: Selected Characteristics of 27 Facilities Visited in Upper East

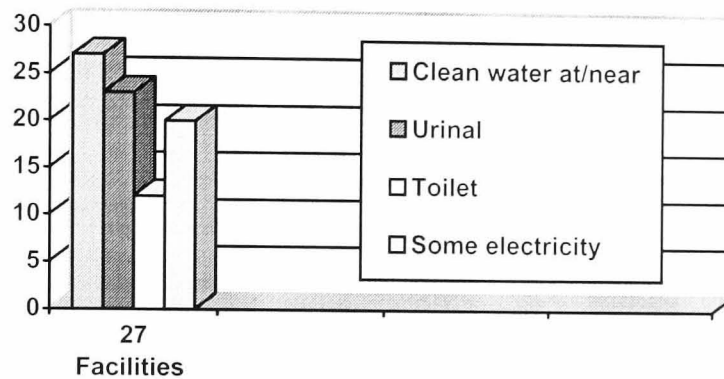

Source: semi-structured interviews and observations 1996-7

Figure 3.5 Percentage facilities with selected clinical equipment on site, Ghana 1996

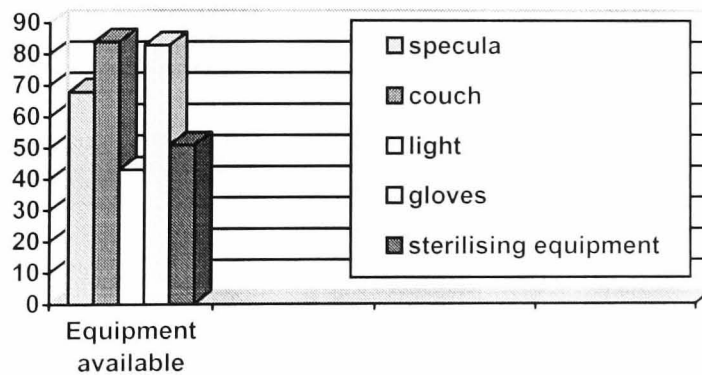

Source: Ghana Situation Analysis (GSS/USAID/Population Council 1996).

Figure 3.6 below shows the hierarchy of services, typical staffing patterns and referral pathways (also see Appendix 8 for ranks and duties of staff cadres and Appendix 10a for facility level classifications).

³⁴ Extensive Situation Analysis surveys were conducted in 1994 and 1996 by GSS/USAID/Population Council on the services and equipment available for reproductive health at clinics nation-wide. This research did not attempt to duplicate these and the results of the Situation Analysis are utilised here to give an indication of the type of facilities commonly available in Ghana.

Figure 3.6 Typical Hierarchy of Services and Referral Pathways, Ghana 1998.

Level	Type of Facility	Typical Staff	Referral
A	Community TBAs, CBDs, Outreach, health posts	Depends on district support 2/3 Nurses from district facilities	To B1 B2 or C for non basic care
B1	Clinics (government/mission) and community clinics	1-7 nurses of CHN - MA rank	To B2 or C for cases needing doctor
B1 B2	Health centres and Polyclinics (some with beds)	6-25 staff of CHN - MA rank	To C or to D if facilities are limited
C	District Hospital with attached out-patients or polyclinic	25-100+ staff of all ranks, headed by a medical Doctor	To D if lab support or advanced support is necessary
D	Regional hospital including referral laboratory	100+ staff of all ranks, several doctors on site	Refer to national hospitals in severe emergencies or for specialist treatment

3.2 POLICIES AND PRACTICES: THE REALITY OF IMPLEMENTATION

All clinics are supposed to follow national guidelines in reproductive health. Most policies focus on clinically orientated STD management, to be undertaken at ante-natal care and family planning services, since these services often already involve some form of physical examination. The practice guidelines outlined in Safe Motherhood Guidelines and Reproductive Health Policy and Standards (RHPS) are summarised in the table below. Each point is discussed in more detail in the following sections. A full policy content summary is provided in Appendix 7.

Table 3.4 National Guidelines on Clinical STD management policy

Clinical STD Management Policy	Source/ date
<ul style="list-style-type: none"> • Clinical diagnosis (on site or by referral) and laboratory testing (refer) if STDs are seen or suspected in MCH/FP. • Syndromic management of STD by clinical and public health staff including MCH/FP staff, referring if the practitioner feels the case beyond their capacity. • MCH/FP staff to conduct routine VDRL screening in ANC. • Verbal screening for STDs (according to questions on standard MoH client record cards) should occur routinely in ANC and FP consultations. • AIDS cases and severe STD cases referred to regional hospital. • STD reagents, HIV testing, blood screening and full counselling services to be offered at regional hospitals. • HIV and Gonorrhoea surveillance at sentinel sites for the national surveillance programme 	<ul style="list-style-type: none"> • Safe Motherhood guidelines, 1994 • STD guidelines 1994 and Reproductive Health Policy and Standards 1996 • Safe Motherhood guidelines, 1994 • Safe Motherhood, 1994 Reproductive Health Policy and Standards, 1996 • NACP AIDS Activities guidelines, 1992 • NACP AIDS Activities guidelines, 1992 • NACP Sentinel Surveillance guidelines

3.2.1 Clinical diagnosis

The definition of clinical diagnosis is that experienced medical practitioners are able to diagnose ailments through their knowledge of typical symptoms but in the absence of laboratory diagnostic support. The Safe Motherhood guidelines specify that clinical diagnosis should be carried out by MCH staff in conjunction with referrals to laboratories or more qualified medical staff. Most staff in the Upper East are forced to rely on clinical diagnosis because laboratory facilities are very limited.

Twenty five of the twenty seven facilities visited said they used clinical diagnosis to identify and treat STDs. Physical screening for symptoms did not systematically occur in any of the facilities visited. Examinations and decisions on treatment were most often done on the basis of the clients' own complaints. The Safe Motherhood Guidelines specify treatment either on site or by referral. Staff at sixteen of the facilities said they always refer STD cases suspected

on the basis of client complaints to senior staff who will diagnose them clinically, or refer them to a laboratory.

There is very little treatment of STDs by MCH or family planning staff. Where MCH and family planning staff did treat clients themselves, they all said they used clinical diagnosis. Figure 3.7 below summarises the type of staff who treat STDs at the facilities visited.

Figure 3.7 Number of facilities with Staff Treating STDs, by staff type
Upper East Region, 1997 (n = 27)

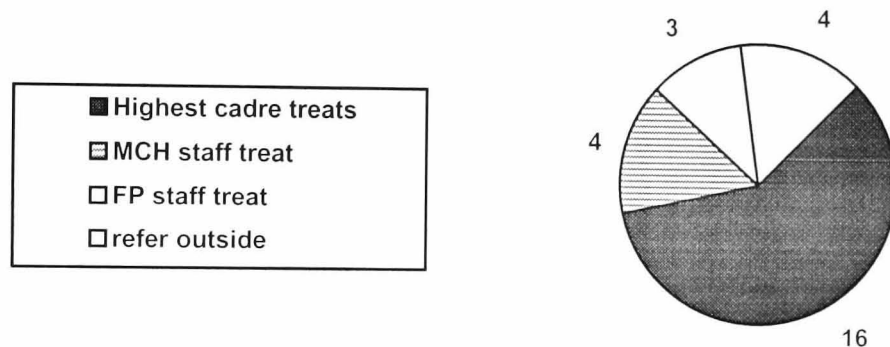

Discharges were treated by MCH/FP staff at only seven facilities and staff at four of these said they preferred to refer cases to an MA or Dr rather than treat themselves. At three facilities family planning staff have drugs on site and said they treated STDs. At all other facilities MCH and FP staff referred cases to the medical officer in charge of the facility. Genital ulcers were always referred to a doctor at a hospital. Of the four specialist MCH centres visited, only two had any STD drugs on site. One was a private maternity home, and one was the decentralised MCH/FP department of Bawku district hospital which is externally supported by German and Dutch Presbyterian mission organisations. The other two MCH/FP centres which are decentralised from Sandema and Navrongo district hospitals had only basic drugs on site and referred all STD cases to the district hospital. These two facilities, one community clinic, headed by a community health nurse midwife and a Presbyterian run mobile rural clinic said they referred all STD cases to the district hospital. Six facilities (3 private clinics, 1 private maternity home and 2 community clinics) have only one health provider on site, none of whom is a doctor. Of these, five said they treated STDs on site, referring to laboratories and to doctors at a hospital when thought 'necessary'.

Training deficits, staff knowledge and resource constraints

There is no data on the quality of clinical diagnosis for STDs. Training in STD diagnosis and treatment of any sort is limited in most training curricula (see Appendix 3 for curriculum manuals analysed), and only one third of the facilities visited had staff who had been to district level 'training' on STDs since their initial qualification. Staff do have some existing knowledge of STD management, which forms the basis for their diagnosis and treatment practices. The knowledge of lower cadres of staff about which broad spectrum anti-biotics to use for which STD symptoms was generally good. Of the eighteen facilities which had MCH staff separate from other staff (excluding where they were alone in charge of a facility), eleven had MCH staff (usually clinical nurses, midwives and public health nurses, rather than the lesser trained community health nurses) who could name the theoretical symptoms (the different types of discharge, the presence of ulcers) and common drug treatments for major STDs (usually tetracycline, flagyl or procaine penicillin).

Nevertheless, lower level staff prefer to refer cases to the highest ranking staff. Figure 3.8 shows that only thirteen of the twenty seven facilities are headed by medical personnel of doctor or medical assistant rank (see Appendix 8 for the national categories of different cadres of staff) which indicates the dearth of higher cadres of medical staff in the region.

Figure 3.8 Rank of Medical Officers in Charge by Number of Facilities Visited, Upper East 1997 (n = 27)

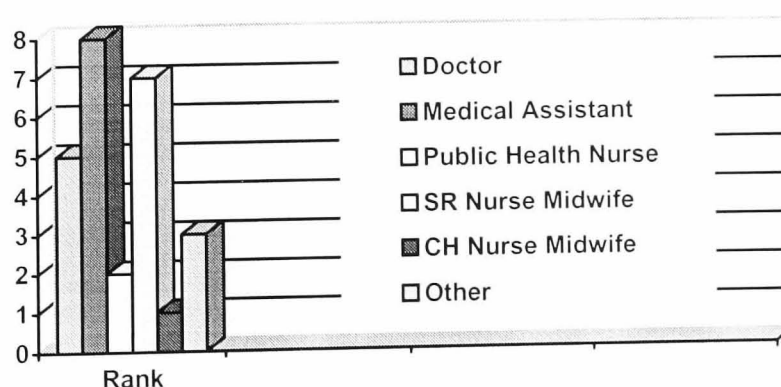

Clinical practice is also hampered by a lack of even basic equipment such as gloves and specula (GMOH(UER) 1996b, 1997; personal observation 1996-7), and for a programme like STD/AIDS management which does not have priority funding status, resources are even more limited. This means that physical examinations involving non-routine equipment may be given low priority because of scarcity and cost. Laboratory equipment and reagents for supporting clinical diagnosis are scarce. Costs of drugs for treatments also emerged as

barriers to effective STD management. They also have implications for the practice of syndromic management.

3.2.2 Syndromic management

'Syndromic management'³⁵ is the STD management policy advocated by the National AIDS Control Programme for health service providers and has been taken up in the latest MCH policy document on Reproductive Health Policy and Standards. Syndromic management is not mentioned, however, in the earlier, but most widely distributed, Safe Motherhood practice manuals (see Appendix 7). It can in theory be performed by nursing and midwifery staff below the Medical Assistant rank and is intended as an improvement on clinical diagnosis and treatment. Fieldwork revealed little evidence that syndromic management was being practised at clinic level either within MCH/FP or outpatients departments. Of the three facilities where staff said they did syndromic management, all such diagnoses were carried out by the medical officer in charge.

STD Training and dissemination of guidelines

Syndromic management is new policy and its practice depends on the extent of dissemination of new management guidelines and of training that has been carried out to teach staff how to use them. Two private clinics and one private MCH clinic had copies of the STD syndromic management guidelines. None of the government facilities had any on site³⁶, though we later discovered that the MoH's 1995 general treatment guidelines also contain syndromic STD management flowcharts, and these guidelines had been more widely disseminated than the National AIDS Control Programmes guidelines (personal communication, regional and district health administrations, 1997). Four Doctors (3 in hospitals, 1 private) and two MAs in other private, primary health care facilities were aware of the flowcharts and even have copies themselves, though we saw none up on walls. Each of the 12 doctors, MAs and senior nurses who attended the regional training of trainers workshop in 1995 were given copies, but none we interviewed had them displayed, either because they said they were familiar with the procedures, or STD screening was not a priority of the clinic, or simply because there had been no follow up to remind them (Interviews, clinic staff 1996-7).

³⁵ 'Syndromic management' is diagnosis and treatment of suspected STDs on the basis of groups of visible symptoms or 'syndromes'. In the absence of laboratory testing this approach treats for all disease that could cause the observed syndromes.

³⁶ A study of 6 hospitals in the southern Central Region of Ghana found 56% clinicians had never seen the national STD treatment guidelines (Bosu et al 1998). A study by JSA consultants of 20 clinics in Eastern Region found syndromic guidelines available in just 37.5% facilities (JSA 1998).

Of 84 clinical medical staff interviewed (excluding those in the 'other' category such as laboratory personnel), 41 (49%) had attended some kind of STD/HIV lecture or training in the last four years. Figure 3.9 below illustrates training that has taken place in Upper East at regional and district level and the number of facilities visited which sent different types of staff to attend them. The bar chart in Figure 3.10 below indicates the numbers of staff of different cadres interviewed who have received regional, district or other training.

Figure 3.9 Facilities with staff who attended STD/HIV training held in the Upper East 1994 - 1997, by staff type (n = 27)

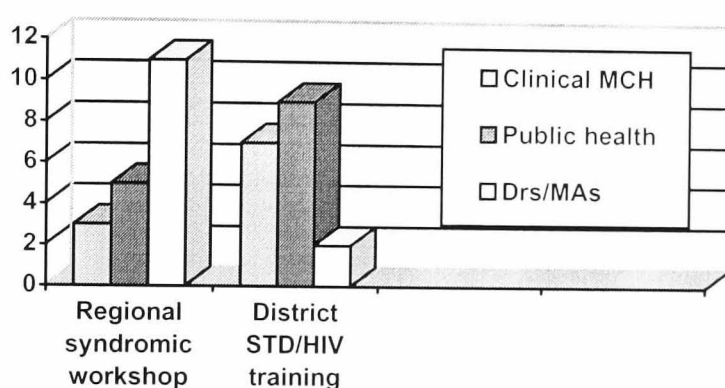
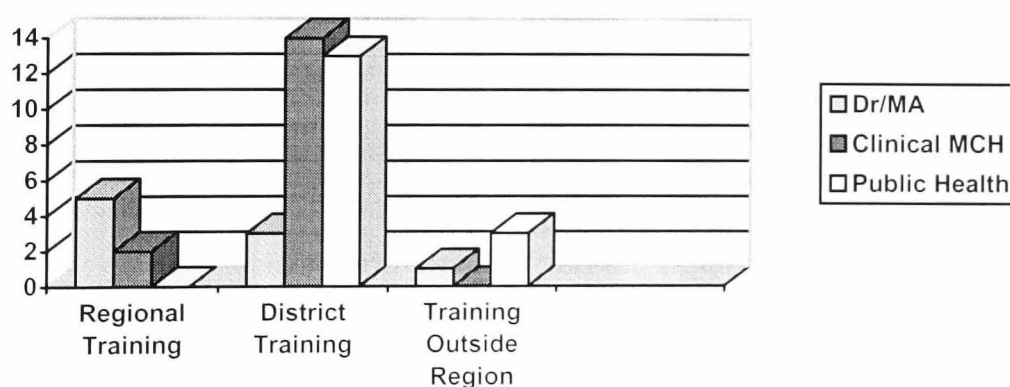

Figure 3.10 Staff (of 84 Interviewed) attending STD/HIV training since 1994, by staff cadre and training level, Upper East Region, 1997



Seven staff from seven different facilities, all in districts close to the regional capital, attended the regional 1995 workshop on STD syndromic management guidelines (see chapter 6). Seven more attended a subsequent workshop on STD/HIV and a further two staff attended an AIDS counselling workshop, both in Bolgatanga. District level trainings were also initiated by individual District Medical Officers at Navrongo, Sandema and Bawku hospitals. Twenty one staff from ten different facilities attended these and four staff from three facilities attended training elsewhere (3 in Tamale and 1 in the US). Only seven of the twenty

seven facilities visited had no staff who had attended any recent STD/HIV training. The quality and depth of district trainings however, varied greatly from a detailed STD/HIV workshop run by a motivated District Medical Officer particularly interested in this topic, to a half-hour lecture on AIDS by a doctor at a district hospital. There has apparently been no follow up of any of these training initiatives.

Family planning nurses can be of any staff category. All but three (one private and two Catholic clinics) of the twenty seven facilities visited offered FP services. Of the thirty eight family planning providers interviewed, twenty six from nineteen different facilities had received some kind of STD/HIV training. Context and quality is difficult to assess - 'training' ranged from one hour to one day.

Figure 3.11 Percentage of family planning providers (of 38 interviewed) who have received some type of STD/HIV 'training'. Upper East Region, 1997

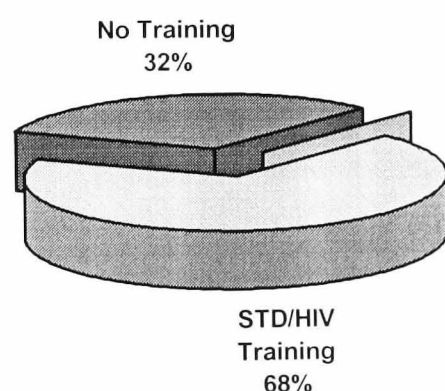

3.2.3 Routine Syphilis screening and vaginal examinations

Routine syphilis screening is supposed to occur in ante-natal care; it is the only explicit STD screening requirement in written policy. Although more than two thirds of women attend ante-natal clinics at some point during their pregnancy, less than a quarter of these women report during their first trimester (GMOH(UER) 1997). Since vaginal and pelvic examinations performed after the first trimester pose an increased threat of infection to the mother and foetus, vaginal/ pelvic screening for STDs (including taking swabs for syphilis screening) is ruled out for the majority who attend during their second or third trimester.

None of the clinics/hospitals we visited did routine syphilis screening or any kind of vaginal examination as a routine part of ante-natal care. Most providers consider the practice obsolete since they perceive the incidence of syphilis to have declined³⁷.

Within family planning services, vaginal examinations and STD screening are also rare except when clients complain of STD-type symptoms. IUD clients, constitute 6.7% of the 9% of women contraceptors in the Upper East (GMOH (UER) 1997). They are supposed to be given a vaginal examination before insertion although there are reported cases of IUDs being inserted when there was obvious discharge (Personal communication, Binaba Peace Corps 1995).

**Figure 3.12 Facilities Performing Syphilis Screening and Vaginal Examination
Upper East Region, 1997 (n = 27)**

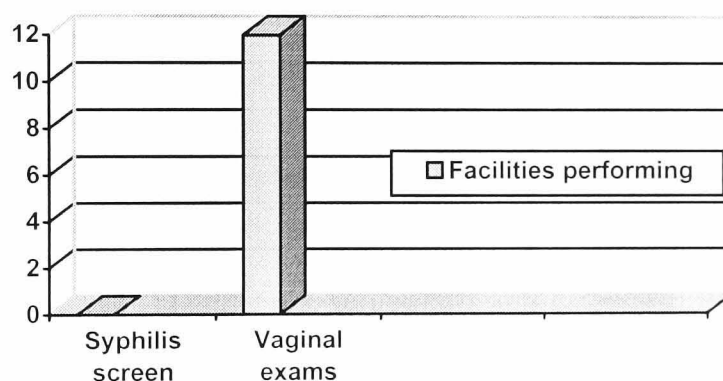

Staff at twelve facilities said they did vaginal examinations and these were either for prospective IUD clients or when the client complained of STD type symptoms. One private Islamic maternity home also did routine vaginal examinations for depo-provera users and the nurse midwife in charge of another private Islamic clinic, said she used to do routine exams for all family planning clients when she had a midwife on secondment from Bawku hospital to help her, but now her workload is too much.

Where staff feel a vaginal examination is needed, but they do not have the capacity to do it themselves, they may refer the client to a laboratory or another facility. Where clients are referred to laboratories for STD tests, staff at four facilities said they could take swabs themselves and then send them to the labs. For the others, samples are taken at the laboratory, or the client has to find a nurse from the hospital to do it. At the regional hospital, one state registered nurse in out-patients said the clients are supposed to take their own

³⁷ The decline in Syphilis incidence over the last decade may be attributable to increased use of penicillin treatment for Yaws in recent years (Interview Dr Sarkodi, 1998).

vaginal swabs 'or they can find a female nurse or midwife to do it.' The laboratory technician will also come to the wards if the patient is too sick to come to the laboratory. There is no data on the competence of nurses, or laboratory technicians, to take vaginal swabs, and training practice in these techniques, even at national level is limited (Interviews at Korle-Bu and Kintampo training schools, 1996-7). This must raise doubts about effective quality care. In tropical climates proper transportation media must be available and properly used since swabs can quickly spoil during the time taken to transport them from the facility to the laboratory (personal communication 1998).

Privacy and issues of exposure were commonly cited as reasons for not examining women unless obviously necessary:

'the clients wouldn't like [routine examinations]. It's not easy to ask them to open their legs and to touch the vagina.'

PHN Binaba

'This is a Muslim clinic and mostly they feel very shy [about examinations for STDs]...they will be embarrassed if they are not given a specific reason...we always explain when they have a real need for us to examine them'

StfNMW I/C Private Islam Maternity Home

'we don't do vaginal examinations because we don't expose her...We only see the private parts if she complains of itching. I can say I can look at it if she wants. You can't just expose the private parts.'

SRNMW Chiana

Lack of facilities and the expense of equipment, tests and drugs were also frequently cited as reasons for the lack of routine examinations:

'there is poor light and when you use the speculum you can't see up it...and there is no bed.'

PHN, Sandema MCH centre

'we don't do vaginal examinations, first because there is no lab to examine and second it would be introducing infection into women because you need

gloves and clients have to pay for them and they are expensive...For FP, for IUD we do vaginal exams. Those who can't afford the gloves do other methods'

PHN Binaba

'now we need to use gloves [because of MoH infection control requirements] and they have to buy them. They are C1500³⁸ a pair...so screening is not practical unless its free.'

PHN Bolga HC

Providers generally agreed that syphilis and other STD screening would be acceptable for family planning and ante-natal clients (though not within other MCH services) if they were given sufficient privacy, if they knew it was a 'normal' part of ante-natal care for everyone and were told why the tests were being done:

'when there is privacy, you can screen and they will accept it.... We need privacy, confidence and time and we need more staff to decrease waiting time for the patients which would encourage the women to come'

PHN, Bolga health centre

Three interviewees at government facilities thought there was still a need for advocacy among staff also on the importance of routine screening. None of the providers interviewed thought routine screening for HIV was acceptable unless it was unknown to the patient which raises other ethical dilemmas.

Despite consensus on the benefits of routine STD screening, the general view of providers was that it is simply impractical unless it is free:

'Women can't afford to go for the tests so...mothers may not be able to come [to ante-natal clinics] at all if screening is routine.'

PHN, Sandema MCH centre

'Poverty is very common in this region...they are scared they have to pay so they don't come...If you say it is free they would come, but who would pay..?'

StfEN, OPD, Bolga hospital

³⁸ About 50p

There is supposed to be an exemption system for ‘paupers’, but it has effectively collapsed. When providers mentioned it, it was usually in the past tense.

3.2.4 Routine screening for neo-natal ophthalmic

Neo-natal ophthalmia is generally seen by post-natal care and child welfare staff. Five facilities (3 private general clinics and 2 small community clinics) did not offer maternity and post natal services. Of the twenty-two which did, most referred cases of neo-natal ophthalmia to district hospitals. Incidence records were not available since reasons for referral are not recorded. Post natal and child welfare staff were not interviewed at all facilities unless they were also involved in ante-natal and family planning services as well, since these were not the primary candidates for interviews. Data on incidence and treatment of neo-natal ophthalmia is therefore incomplete. The highest incidences were reported in Bawku East, the tri-border district.

Of the fourteen facilities who said they saw and treated neo-natal ophthalmia, children were given septrin or penicillin syrup and tetracycline ointment or chloramphenicol drops. All except four facilities said they referred cases, even after treatment, to doctors at the nearest centre, or, in Bawku, to the region’s only ophthalmologist at Bawku hospital. Only three mentioned counselling of the mother for STDs, although more were aware it could be because of infection of the mother.

In a community clinic in Bawku West district the medical assistant in charge said local beliefs make treatment of this condition hard:

‘There’s a local taboo. Babies are not allowed out for the first six weeks after birth, so I never get to see the young ones.’

Yelwoko, MA

3.2.5 Verbal screening

All staff at all facilities visited said they did screen verbally. This means they ask the routine questions on family planning and ante-natal cards³⁹ which are very cursory and truthful

³⁹ Questions on MoH record cards are asked under the ‘medical history’ section in ANC and FP. Clients respond ‘yes’ or ‘no’ to the following questions: ‘Do you have a personal or family history of UTIs, STDs, diseases of the reproductive tract, vaginal discharge, AIDS’. In addition, FP clients are asked some ‘personal history’ questions including the number of current sexual partners. Physical

answers are unlikely to be obtained without sensitive counselling techniques for potentially at-risk clients. Personal observation of consultations and general demeanour of staff to patients at the clinics visited revealed little evidence of this. There is little or no data on the quality of provider-client interaction.

In the out patient departments of hospitals and larger clinics there is a problem of lack of privacy for initial (verbal) screening leading to time wasted by clients being sent to the wrong queue:

'many don't give their correct history. They will only tell you the truth when they are in the consulting room'

SnrStfN, OPD, Bolga hospital

The lack of in-depth counselling which proper screening would require and the time constraints this represents are issues, but there is little/no data on the extent or quality of such counselling techniques.

3.2.6 HIV Screening, Counselling and Management of AIDS

Routine HIV screening does not occur. Testing facilities are only present at Bolgatanga and Bawku hospital laboratories and at one private laboratory in Bolga, to which suspected clients are referred. Although some training manuals do exist, full pre- and post-test counselling services are doubtful (Interviews 1997) and information collected by the GTZ AIDS programme indicated that no pre-test counselling is routinely given (Interview head STD department, Komfo Anokye Teaching Hospital, 1998). Bawku mission-supported hospital has a trained Chaplain who works with 2 or 3 trained AIDS counsellors. Counsellors exist at Bolga and Sandema hospitals, but their efficacy is unknown. One specialist AIDS counsellor had been posted to an area of low incidence, in a rural sub-district where she cannot use her training. She said this was not unusual (Interview, PHN, Binaba 1996). FP nurses do receive some counselling training relating to FP and sexual issues, but there is no quality or performance data on this. The doctor at Sandema hospital remarked

examinations are supposed to be done in ANC and FP to check for abnormalities. For PNC clients, none of this is included. A footnote at the bottom of the PNC card recommends 'FP motivation'.

'We need confidential management - someone people can trust, who won't shout at them.'

Doctor, Sandema hospital

There is little information on consideration of ethical issues surrounding testing and counselling, though a few existing studies indicate that this is an area of concern in Ghana (UNAIDS 1996). These concerns seem to be upheld by the illustrations given by some of the medical practitioners we interviewed who told us how they dealt with testing and counselling sero-positive clients (see section 3.4.1 below on facility based IEC). UNICEF considers ethical issues to be neglected and has just established a Ghana chapter of the African Network on Ethics, Law and HIV which works with the media, medical practitioners and counsellors on AIDS ethics (UNICEF 1996:15).

Management of AIDs is not the focus of analysis at regional/district level. Limited finances and resources mean it basically consists of treating the symptoms of AIDS patients as they appear, and referring suspected clients to hospital laboratories for testing and to Bolga or Bawku hospitals for further treatment. The hospitals advocate home care for AIDS patients. The doctor at Navrongo hospital says this is possible because

'Our tradition doesn't allow us to throw away our family...they will care for you when you are sick, even if they don't want to. That's why we can discharge them home.'

Doctor, Navrongo hospital

3.2.7 Reagents, laboratory testing, surveillance and blood screening

Laboratory facilities, STD reagents and HIV test kits are not commonly available in the Upper East Region, therefore STD and HIV surveillance is limited. Routine sample-testing for Gonorrhoea and HIV are done for 3 months of each year at Bolga and Bawku hospitals which are sentinel surveillance sites for the national STD/HIV surveillance programme funded by USAID. Other than this, testing opportunities are limited, largely for financial reasons. Laboratory resources (from government and donors) tend to be diverted to the bigger, more prestigious public reference laboratories at Korle-Bu and Kumasi, or to specialist, vertically implemented programmes like the national sentinel surveillance.

The Upper East has seven laboratories, six at health facilities and one private laboratory in Bolgatanga itself. Of the facility-based laboratories, there is one at the Regional hospital, two at district hospitals, and one each at a government health centre, a mission clinic and a private clinic. Bongo and Bawku West Districts do not have any laboratory, although Bongo is close to the regional capital.

Figure 3.13 indicates the laboratory capacities of these facilities for screening of HIV, gonorrhoea (GC), syphilis (VDRL) and general non-specific screening through stains and wet-mounts done of vaginal and urethral swabs. Full details are shown in Appendix 9.

Figure 3.13 Laboratories with capacity for selected STD/HIV testing, Upper East Region, 1997 (n = 7)

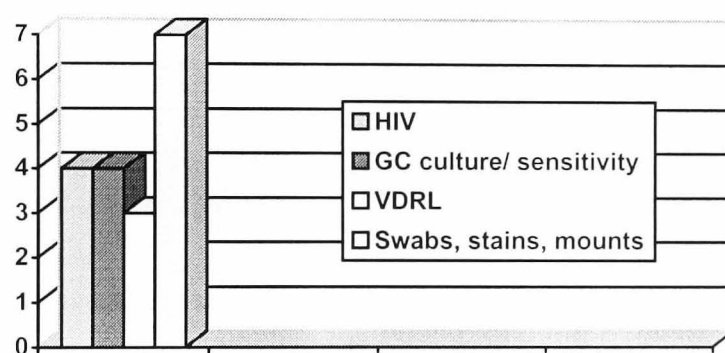

Surveillance through the recording of reported STD cases treated at the facility level is highly problematic. In the initial questionnaires, questions on how STDs were recorded were not asked, but as interviews went on it became clear that most providers who were interviewed said they did not necessarily record STDs as ‘STDs’, but also as ‘UTIs’, ‘gynaecological complications’ or ‘other’, often to preserve the privacy of the patient. The following comments from a hospital doctor and the medical assistant of a well-patronised health centre were typical:

‘I didn’t record it as an STD because she was a small girl⁴⁰ and was so upset when I told her...’

Dr, Sandema hospital

‘We don’t record them as STDs because the patient would be embarrassed...they wouldn’t want people to know.’

MA, Zebilla health centre

⁴⁰ A young woman (probably a teenager). The term is also used for women of low social status.

There is no information on the quality of blood screening in the region. The regional blood bank is at the regional hospital where all donor blood is screened. In 1996, 10 donations out of a total of 1060 were discarded because they were HIV positive (GMOH(UER)1996b).

3.3 CLINICAL MANAGEMENT PRACTICES: REFERRALS, HIERARCHIES AND DRUG AVAILABILITY

Thus far the analysis has presented the practice reality of the different clinical STD management policies. A range of factors is evident which help to explain *why* the practice is sometimes different from the policy. There are important issues about quality, timing and frequency of training which are taken up in chapter 6. In addition to basic resource, equipment and training deficits, there are crucial issues around staff treatment mandates, devolution of authority, drug costs and prescribing practices which are key to effective management of STDs within MCH/FP services. Each of these areas is considered in more depth before a final summary is made.

3.3.1 Referrals, practice-hierarchies and devolution of authority

The practice of referring STD cases seen in MCH or FP units to medical doctors or assistants was justified by staff in the facilities we visited in terms either of quality of care or of the administrative recording procedures (staff interviews 1996-7). Reporting procedures require the doctor or medical assistant themselves to record all STD cases⁴¹. To keep track of such reportable diseases and to minimise time spent on statistics, they often insist that all such cases are referred to them for treatment rather than allow treatment within MCH/FP sites (Interview, clinic staff 1996-7).

While referral is sometimes necessary, over-referral can mean that competent staff are not allowed to operate to their full potential, while higher level staff have to spend time with cases that could be effectively dealt with at a lower level. Dr Sarkodi, director of the national STD referral clinic in Kumasi says simple STD cases get referred to the specialist clinic when they should be treated by Drs or MAs at lower level facilities (Interview, Sarkodi 1998)⁴². Similarly at district and sub-district levels, distribution of workload is unequal. In

⁴¹ The 'in-charge' of the clinic is required to compile data to forward to the district and regional offices. Information systems are dealt with in Chapter six.

⁴² Clinical diagnosis is hard and if symptoms are present nurses who are not specifically trained are likely to want to refer even if the case is actually simple rather than treat on the basis of clinical diagnosis without laboratory support (personal communications 1998).

the Upper East where there is a lack of higher ranks of staff this means that particular cadres or facilities are over worked:

'You have the medical assistants and the public health nurses who are overworked while the community health and enrolled nurses, who have also been to school and are trained, are sitting around with nothing to do... There is the manpower but they sit and do nothing.'

DMO, Kassena Nankana District

The situation is exacerbated by certain attitudes among higher medical staff who are reluctant to delegate their power. Of those MCH and FP staff who said they were allowed to treat STDs and had drugs on site, many said they still usually referred, because of medical hierarchies and reporting procedures. The following quotes were typical:

'I have the drugs here but, [shrugs] well I'm supposed to refer'

FPN, Bongo health centre

'It's because of the reporting, Sup [Medical Superintendent in charge] has to collect all the cases to send to the DMO [District Medical Officer] so he doesn't like us to treat STDs here [maternity block], he likes to see them himself.'

SRNMW, Binaba health centre

'If he [MA] is not here we treat them [STDs], but he's not happy if we do it when he's there.'

Enrolled nurse, Widana health centre

To facilitate improved STD treatment by staff at levels below Dr or Medical Assistant grade where capacities are limited, and to aid the practice of syndromic management, all recommended STD drugs have been given 'Programme Drug' status in the revised Essential Drug List, meaning that all cadres of medical staff are permitted to give these drugs if necessary⁴³.

⁴³ 'Medical staff' as defined in the Essential Drugs List means 'professional' cadres which include doctors, medical assistants and all state registered nurses and nurse midwives and public health nurses. It does not include community health or enrolled/staff nurses who are not considered 'professional' cadres since they undergo only basic nursing training.

In three of the four hospitals visited, 'unwritten'⁴⁴ hospital policy did not allow nurses to give drugs and drugs were not physically available in the different departments (at MCH, in FP or in the wards); the nurses were required to refer cases to a Doctor or MA. Even at the mission supported Bawku hospital which does allow its MCH and FP staff to treat STDs on site, the staff themselves indicated that they still usually prefer to refer clients to MAs or doctors.

The number of facilities which refer STD cases when the staff feel they cannot diagnose or treat them is high as Table 3.5 below indicates. Data on referrals is problematic and some caveats are in order. Since the actual numbers of STD cases seen is unknown because of reporting inconsistencies, the percentage of cases referred cannot be obtained. Moreover, staff do not keep records of what problem clients are referred for, sometimes no record is made at all of cases referred elsewhere. Given the paucity and inconsistency of STD and referral data, it is impossible to obtain actual numbers of STD cases referred. The data in this section are therefore extrapolated from staff responses to answers on how they treat cases, whether they treat themselves, or refer to their on-site superiors, or to another facility. Referrals are often internal, but can also be from lower level facilities to hospitals. At the majority of facilities (19), staff seeing STD cases in MCH or FP units refer them to the clinic superior and if laboratory support is required, refer STD cases to an outside laboratory. All facilities except the hospitals and one private doctor refer cases to another facility if they are severe.

Table 3.5 Type of referrals for STD case management at facilities in the Upper East Region, 1996-7 (n = 27)

Facility Type (# visited)	Referral in-clinic to a superior	Always refer to another facility	Refer 'severe' cases to another facility	Refer cases to an outside lab
Hospital (4)	4	0	0	1
Health centre (8)	7	0	8	6
Mission (3)	2	0	3	2
Private (6)	4	1	5	5
MCH (3)	2	2	3	3
Community clinic (3)	1	1	3	3
Total (27)	20	4	22	20

Referrals can exacerbate financial problems. Staff often acknowledge the difficulties for clients of referring them to a different facility and quotes like the following were common:

⁴⁴ See Parsons (1996) for discussion of 'written' and 'unwritten' policies.

'If I say I'll refer them, they won't go, it's too much money, even if they say they'll go they don't, so I treat them here [on site at the community clinic] if I can'
Yelwoko MA

There is little information on STD referrals in Ghana, but the cost implications for both the client and providers are considerable and certainly need closer attention. One of the benefits of syndromic management is that it allows a decrease in referrals which are expensive in terms of time and money. While nurses should obviously refer if they think a case is beyond their capability, the devolution of authority should be dependent on workload at the individual clinic level, not on medical hierarchies. If the reasons for referral remain those of medical hierarchy and administration, referrals will continue to occur even once problems like lack of facilities and competence of staff are addressed.

3.3.2 Drug availability, drug treatment preferences and costs

The non-availability of drugs at MCH/FP units was noted earlier. The pie-chart in Figure 3.14 indicates how limited drug availability in the MCH/FP units is. Only seven facilities had MCH units with ready access to STD drugs, and only three family planning units did. All others had to refer the client to a doctor or medical assistant for treatment, or to an outside pharmacist to buy drugs.

Figure 3.14 Number of MCH/FP Units with STD Drugs on Site (n = 27)

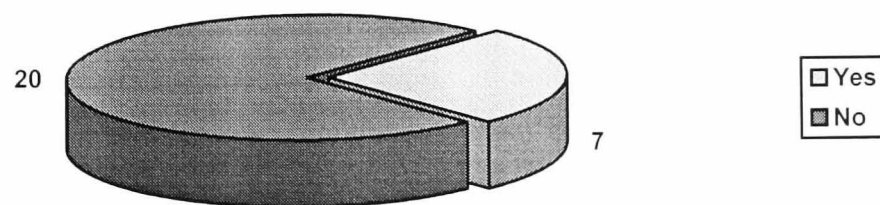

While this may be a function of hierarchical treatment mandates, it is also a function of more general procurement problems which have implications for men as well as women seeking treatment. At two of the four hospitals doctors said they did not implement the STD management guidelines because 'the drugs are not available' (Interviews with doctors in

charge, Sandema and Navrongo hospitals, 1996). Figure 3.15 below shows stockouts of drugs and contraceptives at the facilities visited.

Figure 3.15 Number of Facilities Ever Experiencing Stockouts of Drugs and Contraceptives, Upper East 1997 (n = 27)

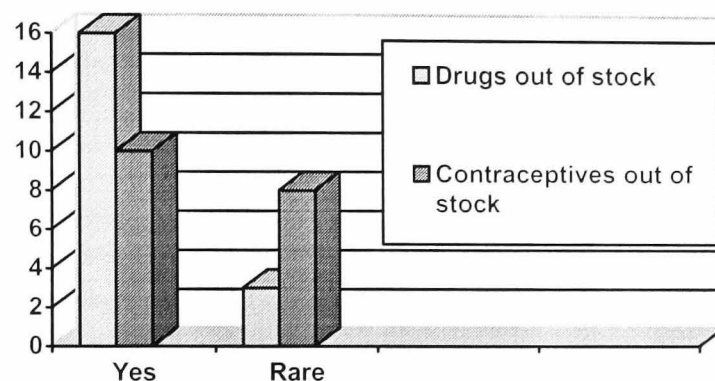

Of the contraceptive stockouts, the majority were of depo-provera (the ‘injectable’) and can be linked to the national stock-out of the drug following controversy over a US shipment of allegedly ‘substandard’ vials⁴⁵.

Five facilities (1 community clinic, 1 private clinic and 3 MCH facilities) stock no drugs or only basic ones (paracetamol, oral rehydration salts) and no antibiotics, therefore they refer all cases needing non-basic treatment. At all the facilities visited, staff said they would sometimes send clients to buy drugs from private drug-sellers (‘chemical sellers’)⁴⁶ if drugs prescribed were unavailable at the facility’s own dispensary. Although during the research period there was no registered pharmacy in the Upper East, staff frequently used the term ‘pharmacists’. Providers recognise pharmacists as popular alternative sources of treatment, often because of issues of secrecy and embarrassment:

‘people fear other people to know [that they have an STD], so they go to drug stores... some feel shy.... if they have a male or female friend instead who can keep it secret, they go there.’

Dispensing technician, Bolga HC

⁴⁵ The incident was a mis-understanding over the meaning of the ‘export only’ tag which the US attaches to stop exports from being illegally re-imported for re-sale by profiteers.

⁴⁶ Pharmacies are at the top of the hierarchy of non-clinical drugs sellers/dispensaries. They are supposed to have a trained pharmacist on site during opening hours; until 1998 there was no trained pharmacist with a private outlet in the Upper East. Below pharmacists come a plethora of private ‘chemical sellers’ which range from well-stocked drug stores run by people with some higher education, selling most major antibiotics as well as Malaria treatment and condoms, to roadside stalls selling paracetamol, antibiotics and penicillin tablets one by one.

Many drug stores stock some of the more expensive STD drugs and are generally accepted as a legitimate source of prescribed drugs. Figure 3.16 below indicates the MoH recommended STD drugs commonly prescribed by providers, those commonly cited as being out of stock at the facilities visited and those not stocked at a sample of chemical sellers.

**Figure 3.16 Common prescriptions and stockouts of MoH recommended STD drugs
Upper East Region, 1996**

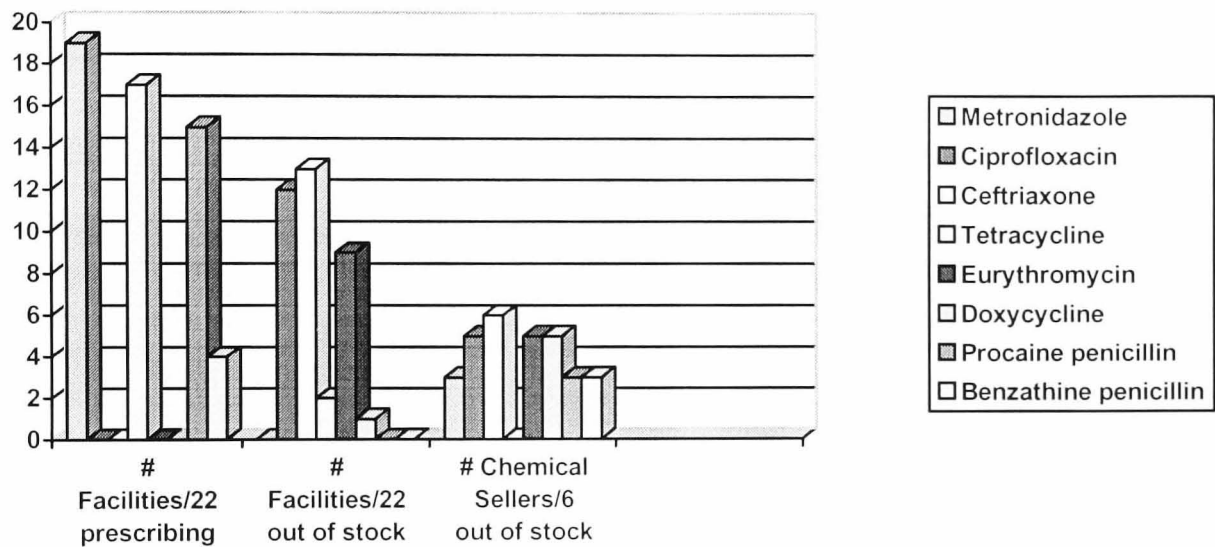

Appendix 10 lists the STD drugs included on the Essential Drugs List of Ghana and the classification categories; Appendix 11 lists those recommended by WHO and NACP STD treatment algorithms. In the facilities, tetracycline and metronidazole are the most commonly used drugs which cover all four main syndromic categories and are both classified as ‘B1’ drugs which allows them to be prescribed in a health centre without a doctor (Essential Drugs List of Ghana, MoH 1996). Procaine penicillin is also common and is a recommended drug for treatment of genital ulcers, again classified as ‘B1’. Septrin is often used because it is cheaper, although not so effective and not recommended as an STD drug in the STD Management Guidelines. Chloramphenicol and ampicillin are not used so much now for STDs. Amoxicillin is used in preference to ampicillin. Generally cheaper and slower working drugs are favoured to enable the client to pay over time and complete the course. Often injectable forms of drugs are favoured for this reason.

‘I use more of the injections [than oral antibiotics] because the fellow will be on it a long time. The injection is slow treatment because it’s not so effective so it takes longer, but...because they will probably still have symptoms, they are likely to return [to complete the course], especially if they know they can

pay over time. People don't have money, so if they buy tablets they may not buy them all [i.e. a whole course]. Injections you can give and allow them to pay back over time...It's not such good treatment but any way it's affordable.'

NOI/C, Kongo private clinic

The presence of drug stores in the Upper East does not appear to help the availability of the more effective, recommended STD drugs like ciprofloxacin, ceftriaxone, erythromycin. These drugs are all commonly cited as being out of stock at health facilities but are also generally unavailable at drug stores. This is probably because the drug stores in the Upper East are 'chemical sellers' not licensed pharmacists.

The cost of drugs can influence the treatment regime prescribed. Doctors at two hospitals said they would prefer to prescribe the more expensive, more effective second line drugs, which they could not get themselves, and they found the lack of availability of these drugs frustrating.

'I hate writing prescriptions and then finding there are no drugs...'

Doctor, Navrongo hospital

They also said that they didn't prescribe these second line drugs, particularly those recommended for gonococcal infections (ciprofloxacin and ceftriaxone)⁴⁷, if they thought their client would not be able to afford them, even if they were the preferred treatment. Cost and availability both influence prescription practice:

'I'm not comfortable prescribing them [expensive drugs] unless I know the patient can buy.'

Doctor, Sandema hospital

'We use tetracycline at this level, though it's not as effective as Doxycycline which is better absorbed, because if we prescribe something that's not available they'll buy something else, and they may end up with stricture or severe PID.'

Doctor, Sandema hospital

⁴⁷A study in Central Region found hospital doctors there were also rarely prescribing these anti-gonococcal antibiotics (Bosu et al 1998).

Cost of drugs and health care to the patient is a well documented concern in both MoH and external health research literature on Ghana (Waddington and Enimayew 1990; Dovel et al 1992; Rakodi 1996); staff in the Upper East echoed the theme time and again. Charges for health care are not new: the 1971 Hospital fees Act introduced token payments which were increased in 1983 and 1985 (under pressure from the World Bank) when the 1985 Hospital Legislative Instrument 1313 decreed full costs were to be born by patients (Waddington and Enimayew 1990; GMoH 1992c). This decision was retracted in the wake of fierce opposition and declining attendance, particularly among the rural poor. In 1992 the current 'cash and carry' scheme facilitating a clinic-based revolving drug funds was implemented (GMoH 1992c; Rakodi 1996). The consensus among staff in the Upper East remains that costs to the client are one of the major constraining factors influencing community members seeking of orthodox health care. There was little evidence of a functioning exemptions system and other sources document its effective collapse through abuse and mismanagement, largely because relatives of MoH staff considered themselves entitled to free services leaving no funds to help genuine paupers (Waddington and Enimayew 1990; Rakodi 1996).

3.3.3 Summary of clinical STD management practices within MCH/FP

The table below sums up the gap between policy intent and the reality of implementation with regard to clinical STD management practices within MCH/FP services in the Upper East Region.

Table 3.6 Summary of STD clinical management practice at facilities in UER, 1996-7

Policy Statement on STD Management	Reality of STD/HIV Management within MCH/FP in the Upper East Region
<ul style="list-style-type: none"> • Clinical Diagnosis • Syndromic Management • Syphilis screening • Referral of severe cases • Surveillance • Full screening and counselling at regional hospitals 	<ul style="list-style-type: none"> • Clinical diagnosis and treatment are commonly practiced, however: there are limited reagents; cost-constraints with effective 2nd/3rd cycle STD drugs; no regulation of training quality. • Most actual and suspected STD/HIV cases are referred by MCH/FP staff to MAs or Drs. (who may be at a different facility). • There are some privacy problems and there is patient resistance to vaginal exposure. • There are problems of partner tracing and treatment. • In public sector facilities syndromic management was not practised. • There has been little training in syndromic management and poor guideline dissemination. • Routine VDRL in ANC does not occur. • There is no quality data on the extent and efficiency of verbal screening for STDs in FP clients. • Referral data is poor; interviews suggest high rates of in-facility and between-facility referrals for STDs and HIV. • Severe STD or AIDS cases are referred to Bolga or Bawku hospitals for clinical treatment. • Surveillance testing for Gonorrhoea and HIV is conducted annually at Bolga and Bawku hospital under the national surveillance programme with reagents supplied by USAID (though national and regional medical stores). • Generally reagents are limited. • STDs are often incorrectly recorded. • Data management capacities at clinic and district level are inadequate. • STD and HIV screening available at regional hospital, but reagents and effective drugs may be limited. • Counselling services doubtful.

3.4 HEALTH INFORMATION, EDUCATION AND ADVOCACY

Public health strategies, while often stated as a necessary accompaniment to clinical strategies, receive little priority in policy documents. The importance of long-term preventive and public health STD/HIV strategies is internationally recognised and most donors pay them

lip service, but such activities tend to be under-resourced and under-prioritised. Almost all health staff interviewed in the Upper East cited health education and information awareness activities, preferably in the communities, as the most important means of bringing about a long term reduction in STD/HIV incidence.

The term 'IEC' (Information, Education and Communication) is commonly used in Ghana as a uniform term covering a whole range of information, education and communication activities. When health staff talk of doing IEC, they generally mean health education talks. These may be one-to-one within client consultations, or to a group of clients. Outreach is another explicit form of IEC, generally involving group talks. Sometimes a regional team may do a specific education campaign and take a van with a megaphone into town markets with health messages playing. Posters and occasionally cassettes are also used in clinics, to put health education messages across.

A general problem is the lack of appropriate educational material in the Upper East. Designing and printing of posters and leaflets takes place in Accra at the Health Education Unit's HQs. Funds are not forthcoming to aid decentralisation of production. This means there is a language problem and sometimes inappropriate subject matter. Some local NGOs like PPAG, Ghana Red Cross, and Rural Help Integrated produce their own materials when they have money - usually to respond to current public health crises. Action Aid has translated three MoH-produced leaflets on AIDS into the main local language of the 2 districts (Bawku-West and Bawku-East) where they are working in the Upper East.

Language emerged as a significant general problem which can affect interactions between community members and medical personnel at all levels, at all points of contact and is particularly pertinent for the providing of health education:

'I provide health education, but there is a language barrier. The mothers come from all around so I don't always speak their language...it's a problem'

MA, Yelwoko community clinic

'We used to have a nurse in the corridor [giving health education talks], but at times the nurses may not speak the local language, so it depends on when there is a native speaker.'

EN, Sandema hospital

The community clinics, the mission clinics and some of the smaller outposts and outreach clinics which are staffed by non-local speakers often have 'interpreters' present. In all the clinics we saw, they were always men, often a TBA, which presents obvious barriers to the effectiveness of verbal screening for sensitive subjects like STDs in women.

Hierarchy and status issues also have an influence on the way health professionals give advice or information. There are few data on this, but some Ministry of Health surveys have indicated client dissatisfaction with the sometimes arrogant and insensitive attitudes of health staff, particularly towards the young and the illiterate (Huntington et al 1990; Richardson et al, 1992; Dovel et al 1992). Staff often talked to us of 'ignorant' and 'illiterate' villagers in a disparaging way.

The table below indicates the public health policies relating to STD management. For full details see Appendix 7.

Table 3.7 Public Health Management policies

Public Health Management Policies
<ul style="list-style-type: none"> • STD education is to be given to suspected STD clients in MCH/FP and OPD. • STD and HIV education is to be given to FP clients when they come for FP. • STD/HIV information is to be one of the topics covered during general health talks. • STD/HIV information and education is to be included as one of the outreach topics. • Condom advocacy is to be a part of STD/HIV education and information. • Condom distribution is to occur within FP and on outreach. • Partner tracing and follow up should be carried out by public health staff. • Counselling is supposed to occur if a family planning or ANC client is diagnosed as or suspected as having and STD.

Source: Safe Motherhood Education protocols, 1994; Reproductive Health Policy and Standards, 1996.

3.4.1 Facility-based information/education, counselling and provider-client interactions

Some general information is given on signs and symptoms of STDs and HIV/AIDS during general clinic talks to various groups (out patients, ante-natal, post-natal) during waiting time. AIDS particularly is often mentioned by health personnel in general talks. It is more difficult to ascertain how much STD education is occurring because there is considerable confusion and lack of differentiation between STDs and HIV/AIDS. Many times we asked about STDs and the reply was obviously about HIV/AIDS. The terms 'HIV' and 'AIDS' are

often used synonymously even in official data, (National and regional annual reports 1994-6; Rose, 1996). The charts below indicate numbers of facilities which give talks on STDs and AIDS.

Figure 3.17 Facilities giving talks on STDs (n = 27)

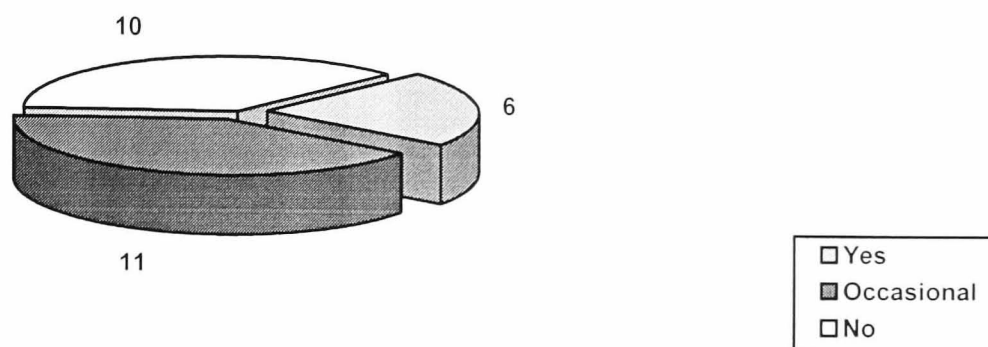
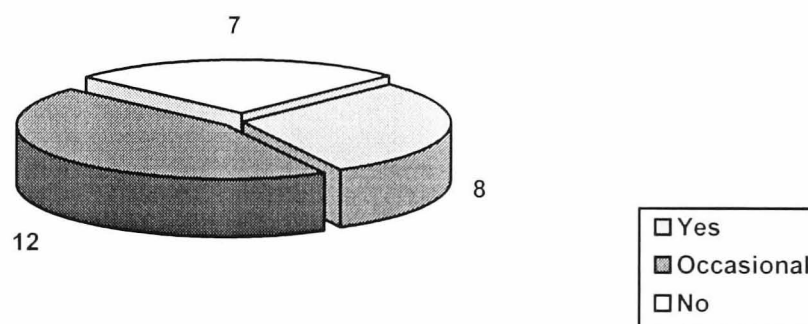

Figure 3.18 Facilities giving AIDS talks (n = 27)



Whether STDs are perceived as a priority or not (a status often dependent on accurate surveillance) can have an impact on what IEC is given and in the Upper East region health education topics are crises orientated:

'We have a book to write down what diseases are most prevalent and based on that, we determine what health talks to give - so with regards to the STD talks, it depends whether the Dr. has recorded the infection as an STD in the book. If not, they don't talk.'

MA, Bawku hospital

Providers generally consider it acceptable to give information on STDs and HIV to any client regardless of what services they came for, provided it was handled in a sensitive way. Many suggested tagging it on the end of another health talk, or leading up to it using other topics.

Many spoke of the need to apply psychology to the situation if people were to listen and take the messages seriously.

Staff recognise the need for sensitivity of interaction and counselling on sexual topics. However, personal observation and informal talks with a number of receivers and providers of counselling, consultations and health education, indicates that quality of care in these areas is extremely deficient. A number of publications (GMOH 1992b and research by Johns Hopkins in early 1990s; Richardson et al 1992; MoH-Liverpool School of Tropical Medicine 1994) suggest that provider attitudes and inter-personal skills may be a barrier to health seeking behaviour and effective policy implementation.

All health personnel cover health education and basic counselling skills in their training, but quality control and monitoring and evaluation of their practice is not, so far as could be ascertained, undertaken, at any rate on a regular basis. While there are a few AIDS counsellors in the Upper East, some supported and trained by churches, most clinics do not have one⁴⁸. MoH AIDS counselling guidelines emphasise the need for religious and cultural sensitivity (MoH AIDS counselling guidelines, 1995) but there are no legal and few medical guidelines covering how and what you should tell an infected client. Questions of ethics are seldom addressed. In several facilities in the Upper East, misinformation was intentionally given to STD and HIV infected clients to 'cushion' or protect them from the truth since STDs are socially unacceptable, particularly for women (Interviews, clinic staff 1996-7).

If providers believe a client is or could behave irresponsibly, they may take matters into their own hands and develop their own methods to reduce potential risk. This raises serious questions however, on medical ethics and the spreading of mis-information about which there is increasing national concern (UNDP 1994; Unicef 1996). A private practitioner in Bolga who has recorded more than 40 HIV positive cases between 1992-1996, described some of his counselling techniques:

'We use Adolment, a drug used in treating hypertension, but when men take it they become sexually inactive, so if I think the guy is a threat to society, we give him that to take one tablet at night - his penis will just lie down...Some we advise to join spiritual churches - the paster will definitely talk about

⁴⁸ Data on numbers of counsellors is not available: neither the Regional Health Management Team manpower data nor the regional hospital annual report for 1996 list any AIDS counsellors. Bawku district hospital (supported by the Presbyterian mission) has trained 4-5, but MoH trained counsellors are few.

fornication and he [the patient] will not like to do it again...Those who are victims [of HIV] like the men, we have a certain method we use to prevent them spreading it. We tell them it takes 5 bacteria to cause HIV, you have 2 or 3, it takes 3 more to qualify you for AIDS, therefore what do you do not to qualify? We tell them that maybe the next woman you meet is carrying the 4th bacteria and you'll get AIDS. We tell them to report every 2 weeks and we ask about their sexual habits. They say "I've never gone to any woman again, only my wife." I tell the same story to the girls who come here with HIV. I tell them they have 4 viruses and the next man they meet may have the 5th. If they are doing it for a living I tell them to make sure the men wear a condom. I ask them to report every 2 weeks and I ask them about their sexual habits.'

MA, Asankunde private clinic

There had been no follow up of any of the counsellors we interviewed, to check on quality of care, because there are no designated funds since counselling and behaviour-related strategies are not a national or regional priority. Private initiatives work in localised areas for example Action Aid's HIV education campaigns in Bawku East district and the Presbyterian supported counselling services at Bawku hospital (Interview, Action Aid programme manager 1997; Interview, Bawku hospital AIDS counsellor 1996).

3.4.2 Community information and education

There is some community outreach which involves health education, including messages on faithful partners, not getting treatment from quacks, not going to local *wanzams* (circumcisers) or at least ensuring that they use clean knives for different children. The chart below indicates the number of facilities doing outreach education of any kind.

Figure 3.19 Facilities doing Outreach Education (n = 27)

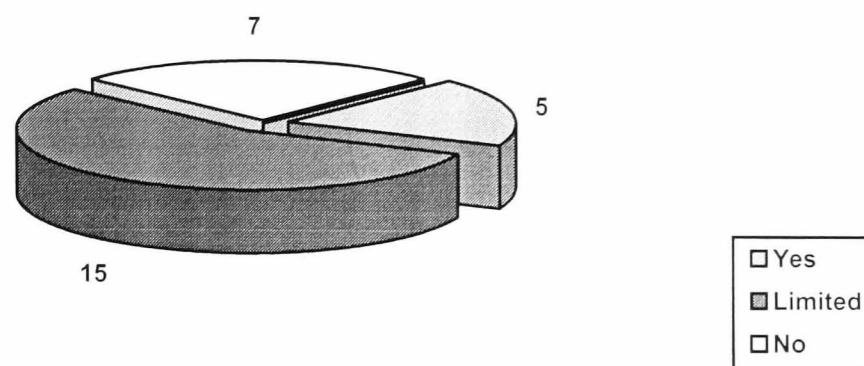

The main problem cited was lack of funds for transport and appropriate education materials for northern communities since most are produced in Accra. Access is also a problem, and ensuring that villagers will be there when the outreach team arrives. Staff often go on foot or bike to the nearest villages and even pay for vehicle repairs out of their own pockets (Interviews and personal observation 1996-7; Binaba PHN 1997). Bad roads and transport and fuel constraints are recognised by the regional administration as having a major impact on service delivery, but the region does not have sufficient funds to address the problem (GMoH(UER) 1997).

'We do outreach, but the car broke down...it can take 5 or 7 days to mend, so we had static clinics here under the tree until the Doctor gave us an old moto...[but]the rains mean the roads are inaccessible...'

CHN, Wiaga Catholic clinic

'CHNs [community health nurses] go on outreach whenever they have means [transport]...when it rains the response is poor. We used to have one truck for the DHMT [district health management team], now we have 2 but only 1 driver...we give our itinerary to them, but there's no fuel, or it's broken or it's out...and you may get there and people won't come...so we stopped going'

PHN, Bolga HC

'You need to go either very early in the morning at this time of year [harvest] before they go out to the fields, otherwise in the evening when they are back from the harvesting'

CHN, Wiaga Catholic clinic

For men and women, providers agree that talks on STDs and HIV/AIDS were more effective in the villages than at the clinics:

'[in the clinics] when you ask questions they feel shy to talk, they normally don't want to open their mouth, they don't want to get involved themselves...in the village they're very interested and want to ask questions.'
ENMW, Widana HC

'On Friday we went to one village with the CHN for this polio immunisation and they themselves were asking questions on HIV and FP, so we were happy they were so interested. One lady asked us if it was true that if you have fast sex you don't get HIV. The chief even asked us to arrange an education programme for them, but we have to foot there [i.e. walk] so we won't be able to...some are really interested.'
ENMW, Widana HC

The regional health administration sometimes sends vehicles into the towns on market days to play pre-recorded health messages through a megaphone. This usually happens as part of special mobilisation programmes, for example mobilisation for the national polio immunisation day, or messages prior to the time meningitis outbreaks occur, telling people the symptoms and when to come to hospital. These initiatives are usually centrally funded either from Accra or Bolga.

Other actors are involved in community 'education' strategies. Action Aid runs peer education activities (funded by UNICEF) which include games and role plays for young people; the local FM radio stations of the Ghana Broadcasting Corporation aired several discussions and jingles on AIDS in 6 local languages in 1995 (GMOH(UER) MoH 1996a).

3.4.3 Reaching men and teenagers

Male and female providers regarded IEC for men as difficult but essential. There was consensus that the spread of STD/HIV infection was due primarily to men's sexual networking habits:

'...it is the man who will have been sleeping around more than the women, that is normal for men in this culture...although our culture points to the woman...so where does the woman go to get treatment?'

Male StfEN, Bolga hospital

'With the men it's hard [to treat STDs] because in our culture they move around and can re-infect'

Male SnrEN, Bolga hospital

'It's a problem treating patients because most men go secretly to do their own thing'

Male MA, Asankude private clinic

Many nurses felt male personnel, like the agricultural extension workers, would be more suitable for reaching men in the communities. Other venues like market square speakers on market day, or at Durbaahs were also suggested.

'It's the men mostly that don't want to sit down and listen...you could talk to men's groups and invite men together...but it means transport again and that's our main problem.'

PHN, Bolga HC

'We have to organise the men. You could talk to them in pitou bars - most of them drink - and on the farms...we should integrate with Agric - most of them will not listen to a nurse. They see a nurse coming and think you are wasting their time, whereas if they see an Agric man coming they know he is their friend and they will listen if he talks about AIDS.'

PHN, Bolga HC

Reaching teenagers is a particular problem and is little addressed at present, though a national adolescent reproductive health policy has recently been formulated (proceedings of Adolescent Reproductive Health workshop, 1996). A number of facilities we saw had teenagers attending, but no special days or rooms were available for them. Public health staff are sometimes invited to give talks on family planning and sexuality issues at schools in the districts. According to a number of NGOs and some local prevalence surveys in Ghana, abortion rates, especially among young women, are high (personal communications GTZ.

HRU-MoH 1996-7; Nabila et al 1996). An unpublished survey of abortion rates among family planning clients in PPAG clinics nation-wide, found a 19% rate (PPAG/MoH unpublished survey c.1992) and a study at Korle-Bu (the national teaching hospital) showed that septic abortion was the principle cause of death among adolescent women (Nabila et al 1996). Official data is not available since abortion is illegal except in cases of rape or threat of maternal death (Criminal Code (Amendment) Law PNDC L.102, 1985). Peer education activities are being undertaken in the Upper East by some NGOs like the Red Cross and Action Aid. The MoEducation is involved in raising awareness in schools under Family Life Education programmes - supported by UNICEF (Interview, Regional School health co-ordinator, MoEducation, 1996).

3.4.4 Condom advocacy and cultural acceptability

Although twenty three of twenty seven facilities had condoms on site, condom advocacy is limited. A truly integrated outlook for reproductive health services would address the question of contraceptive choice, and the advocacy of condoms both as a contraceptive method in their own right and in addition to another contraceptive method for the prevention of STDs and AIDS. Interviews and observations indicated that advocacy of condoms to MCH/FP clients is rare⁴⁹ because STD management is not a priority in the region though reduction of fertility is. This stance is partly influenced by the still low cultural acceptability of condoms in many parts of Ghana (see chapter 5). The concept of dual contraception (spontaneously mentioned by just one provider) is not even an issue, so there is no sense of the 'contraceptive choice' dilemma that is found in other countries for example in Latin America (see Cates and Stone 1992a, 1992b and Finger 1994). This perhaps indicates a certain lack of commitment to integration of preventative strategies which is echoed at national level (see chapters 7 and 8).

⁴⁹ In a study of 6 southern hospitals, condom promotion was scarcely or never undertaken even for patients diagnosed as having pelvic inflammatory disease (Bosu et al 1998).

Figure 3.20 Facilities with condoms on site and doing condom advocacy (n = 27)

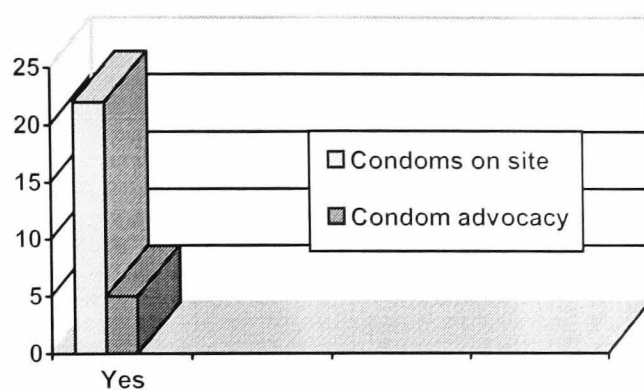

Since family planning and STD/HIV related services interface with intensely private parts of individuals' lives, privacy and confidentiality are highly important in all aspects of service delivery; this is recognised by health workers:

'some women don't want their husbands to know they are having FP because their husbands are against it. They want to consult privately and secretly with the nurses in their homes or at the end of the day.'

DMO, Bongo HC

'Most clients like [FP] done secretly so we see them one at a time...in Africa there are taboos on these things. Some have problems of husbands - they themselves understand the nature of FP but their husbands don't, so secrecy is very important.'

MA, Asankunde private clinic

'If you go to [teenagers'] homes they pretend they don't know [about FP]; they would rather come to the clinic under cover, on market day under the pretence of seeing a friend or a patient. They hide and come...they don't discuss FP openly'

PHN, Binaba HC

'Men come under cover to my house for condoms.'

PHN, Binaba HC

3.4.5 Partner Tracing

Efficient STD management requires treatment of all partners of infected clients - a notoriously difficult procedure, especially where men generally relinquish responsibility.

'We tell them the men can give them cross infection, so we tell [the men] to refer to a Dr. for proper treatment...most of them don't go, especially those in the polygamous marriages, they say you the woman are having the infection so you should treat it.'

Stf NMW I/C, Private Islam Maternity Home

'in most cases, the men are always difficult...they won't come, they say it's the women who brought the infection.'

FPN, Navrongo hospital

There is little information or data on partner tracing⁵⁰. In the absence of clear guidelines, service providers either do nothing or use various ad hoc strategies to trace and treat partners:

'After a positive result we ask for the partner. We ask them to say "I've gone to the Dr. and he says I'm not well and that you should come"...they don't take it seriously.'

MA, Bawku hospital

'When a man is sick with an STD, he goes to the out-patients department, where he is told to come back with his wife....until then he is given a placebo...When he comes back with his wife, they start treatment at the same time'

FPN, Navrongo hospital

'if he is married we include his wife and girlfriends, though he won't agree to bring them, but we write prescriptions for all of them for him to go and buy. We ask him to come back for review...normally they don't come back

⁵⁰ Partner notification and management was rarely or never undertaken for PID sufferers in hospitals in Central Region (Bosu et al 1998).

because they say they are OK. They refuse to come, but we expect that they omit treatment'

MA, Bolga HC

'The time they [men] come with symptoms it [the STD] has advanced far. I say to the women, that if the husband has symptoms and you don't so you think you don't need treatment, but I tell them for women it takes time [for symptoms to appear, so she should also get treatment].'

NOI/C, Kongo

'...when we diagnose an STD they find it difficult to tell their wives - there would be war at home. So usually while treating the men we try to lure women to come to hospital for the slightest headache, we tell the men to watch out and if she complains of anything, tell her that I said she should come, and when the women comes you act as if it's for the headache and you can treat her [for the STD]...If you mention the man has Gonorrhoea the woman will cause problems for the man...Some men are bold and will come with their wives...For the women I just tell them direct to bring their husbands. I interview him and say that his wife has a small infection, so both have to take the treatment.'

MA, Asankunde private clinic

3.4.6 Summary

The Table below summarises the policy-practice gap for public health STD policies in the Upper East:

Table 3.8 Summary of public health STD management practices, Upper East Region 1996-7

Policy statement on STD management	Reality in the Upper East Region
<ul style="list-style-type: none"> • Education to suspected STD clients in MCH/FP and OPD • STD/HIV education to FP clients • STD/HIV topics in general health talks • STD/HIV information on outreach • Condom distribution on outreach • Condom advocacy • Partner tracing 	<ul style="list-style-type: none"> • STD education is usually given only to symptomatic STD clients in MCH/FP or OPD. • STD/HIV education is only given to symptomatic FP clients. • HIV education is often given during general talks. STD talks are rarely given. • STD/HIV education and information on outreach is rare, though providers report that villagers are interested in sexual matters. • Men are particularly difficult to reach. • Transport costs are a barrier to regular outreach. • Condoms are irregularly offered as part of outreach services by health and agriculture personnel • Condoms are seldom advocated to women contraceptors • Partner tracing and follow-up are attempted where there are resources and dedicated staff - results are mixed. • In general, 'IEC' receives low priority and little funding.

3.5 SUMMARY

'We are very good at writing decent policies but when it comes to implementation there are definite problems.'
Senior civil servant in the MoFinance (Interview 1997)

It is evident that despite policy specifications on a number of strategies to integrate STD management into FP/MCH services, current services are unable to offer sufficient resources, privacy or counselling skills to effectively manage sexually transmitted diseases and reproductive health issues. The chapter has identified a range of 'contextual' factors which

influence and help to explain why the reality of implementation can be so different from the policy specifications. These contextual factors can be summarised in three clusters:

- ‘Clinical-technical’ factors including lack of screening equipment, lack of privacy, lack of appropriate education materials, the questionable efficacy of syndromic vs. clinical management and high costs of STD tests and 2nd cycle drugs.
- ‘Systems-management’ factors such as lack of STD management guidelines, training and follow-up, poor 2nd cycle drugs supplies, non-availability of STD drugs in MCH/FP units, inconsistent reporting and data management, lack of priority to and funding for STD/HIV issues and for education and preventive activities which are crisis orientated.
- ‘Social-behaviour’ factors encompassing staff attitudes and hierarchical treatment practices.

Service provision should not be the final aim of policy implementation; the potential success of policies is dependent on service utilisation. The next two chapters turn to the sub-district level to contextualise the environment in which health workers provide services and the people for whom these services are being provided.

CHAPTER FOUR

COMMUNITY CONTEXTS: EXPERIENCING HEALTH SERVICES

Laadi is 6 months pregnant. She has walked for 2 hours from her village to get to the health centre at Binaba. Along the red dust road the complex of dirty white buildings are almost visible, surrounded by their dry fields with the cows and chickens wandering through. Laadi came yesterday too. Yesterday was market day and she managed to get a ride with a small market truck sitting on the rough metal floor squashed between baskets of dried fish, tubers of yam and sacks of rice. But yesterday the senior ante-natal nurse had gone to her home village to visit her sick mother. The Medical assistant was at a meeting. The other nurse there said she couldn't give out drugs for the discharge that was worrying Laadi and told her to come back another day if she wanted to see someone senior who could give her medicine. Laadi's mother said discharge was caused by eating too much sugar. But she hadn't eaten any sugar for a long time. So now Laadi is walking, no market lorries today, sweating in the 40 degrees heat, with her little money tied in a corner of the cloth she wore round her waist. She hopes there will be enough money for the medicine. Perhaps she should just go to the drug store and ask for a tablet...

The scenario above is fictional, but 'Laadi' is a real person, and the story was built up from actual observations made during several months of living in the sub-district of Binaba-Zongoire. This is the reality of health care for rural women. If women can get to the health centre, which is often in need of physical maintenance, the staff able to treat them may not be there and lower cadres of staff may not be able or willing to treat STD-type symptoms like vaginal discharge. Cost is an ever-present constraint.

Feedback on the impact of policies at a local level is perhaps the most crucial stage in the cyclical process of policy development, but is also the most neglected. The preceding chapter has introduced clusters of contextual factors that affect the implementation of STD/HIV management policies (service delivery) at the clinic level. This chapter seeks to illustrate the wider service delivery context at the sub-district level.

The analysis is primarily concerned to illustrate and understand the actual context of people's lives and health-options. It describes the physical conditions in which people live, and assesses the nature of the 'western' medical services available to them and the impacts of these on service utilisation. The first section gives an overview of Bawku West district and Binaba-Zongoire sub-district, its health profile and the presence of NGOs and missions in the area. The health service options available to people in a rural sub-district are the subject of

the second section. The third section looks at how the provision of these services affect community health seeking behaviours and explores in more depth the complex interplay between social-behaviour factors and the clinical, structural issues of service delivery.

4.1 BAWKU WEST: A RURAL ARCHETYPE

The focus of this chapter is Binaba-Zongoire sub-district; one of five in the newest district in the Upper East Region, Bawku West. Bawku West has a population of 22 824 in 26 scattered communities with a population density of c.88/km² and an estimated annual growth rate of 2.5 (GMOH(UER) 1997). People are predominantly traditionalists (90%), the rest are Christians (6%) and Muslims (4%) (Knudson 1994). In some areas the numbers of Christians and Muslims are considered higher than these figures, but in reality there is a lot of dual belief.

Figure 4.1 Map of Bawku West and Binaba-Zongoire Sub-district

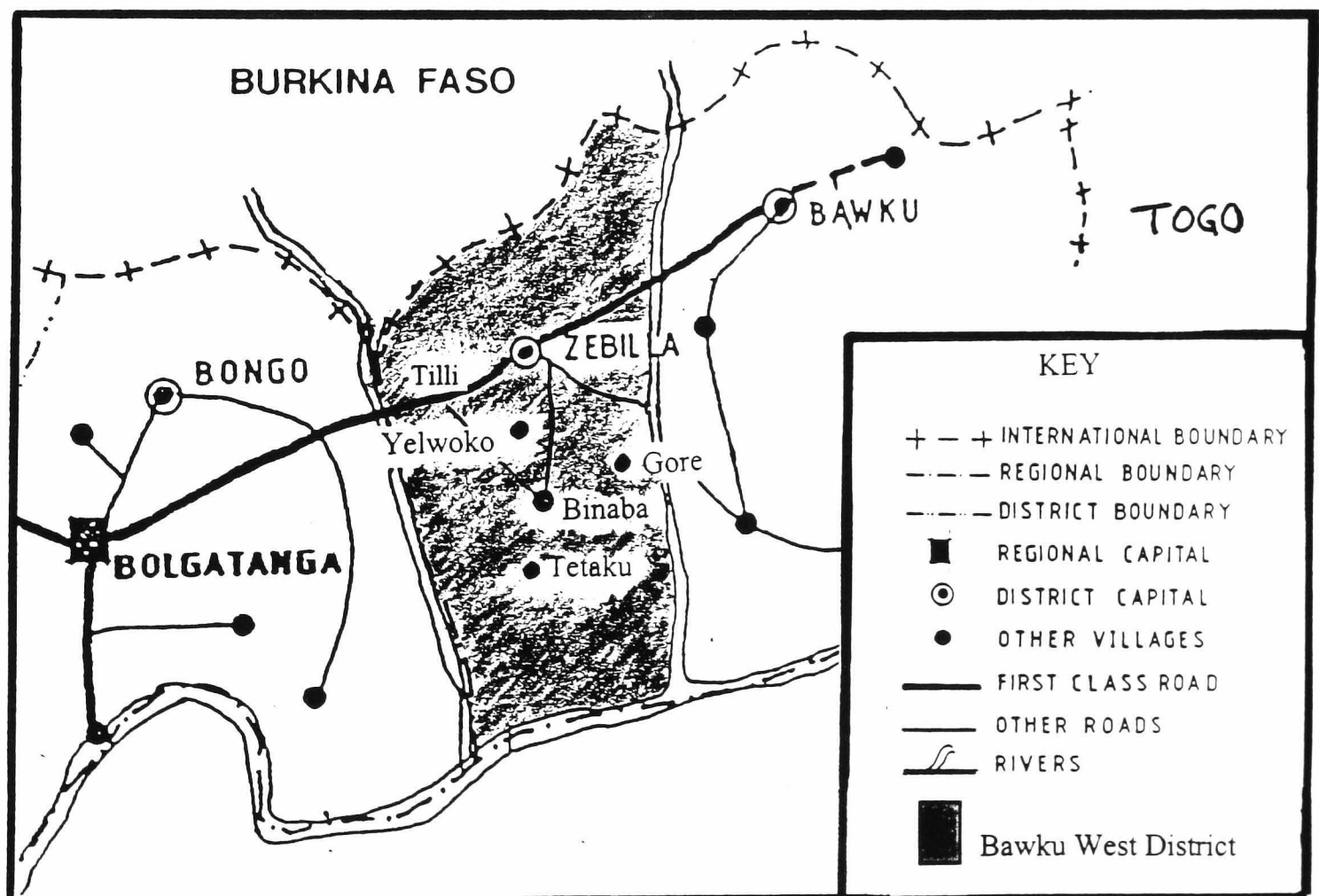

4.1.1 Living environments and health profile: the context of life experiences

The scattered communities are, as throughout the region, largely subsistence and small-scale commercial farmers. Binaba town itself has a higher proportion of semi-skilled craftsmen, labourers and professionals (nurses, teachers etc.) than in the surrounding villages since it is one of the major towns in the district. Communications are poor; the district capital, Zebilla, is situated on the only major road in the district (see map). There is one main laterite feeder road to Binaba, the district's second town, but all other 'roads' in Binaba-Zongoire sub-district are dirt tracks, dry stream beds or footpaths.

Laadi's village, Yelwoko, shown in the photographs, is typical of the area. Transport is difficult; market trucks go between Bolgatanga to Binaba and will squeeze passengers in among the produce for a small fee. Public vehicles do not travel to Yelwoko village, so you have to get off on the dusty laterite road at the village of Kukore. From there Yelwoko is a hour's walk on foot along a track which is a dried up stream bed. The scrubland around is fragmented by rocky outcrops and scattered mud-hut compounds, surrounded by cleared, ploughed fields.



Figure 4.2 Hut compounds surrounded by tilled fields

As you near the village, dusty, naked children run out to greet you, their feet and lips cracked in the dry heat, flies playing about their eyes, bellies swollen below stretched rib-cages. By the smooth red mud-compounds, with tiny sleeping-huts arranged in circles around a series of courtyards, men lounge in the shade of the walls, their energy burnt by the heat. Women hover around huge cooking pots simmering on burning logs under a tripod of stones, cooking rice or millet for the families' daily meal. Pepper and tomatoes are ground, maybe with some

tiny dried fish, as an accompaniment to the filling starch. The 'big men' of the village will have meat too - freshly slaughtered, drying on the stones beside the pots.



Figure 4.3 Grain stores and huts in the chief's compound



Figure 4.4
Courtyard with
shea nuts drying

Yelwoko is lucky, it has two bore holes (provided by the Canadian International Development Agency and the government of Ghana) from which water for drinking, cooking and washing can be fetched. They often serve as meeting points for women and children coming to fill their buckets. Children of six or seven carry full buckets on their heads, their arms barely reaching the rim. Cows and pigs wallow in the mud-pool around the bore holes. The 150 families of the village are spread far though, and many people still use well or (during the rains) stream water. None of the compounds have a sanitation infrastructure though a few of the wealthier families, including the village priest who has a degree from the UK, have a pit-latrine. Most villagers use the fields around their compound, or the scrubland of the bush as toilet facilities.

Figure 4.5
Bore-hole with
mango tree
in a walled
garden behind

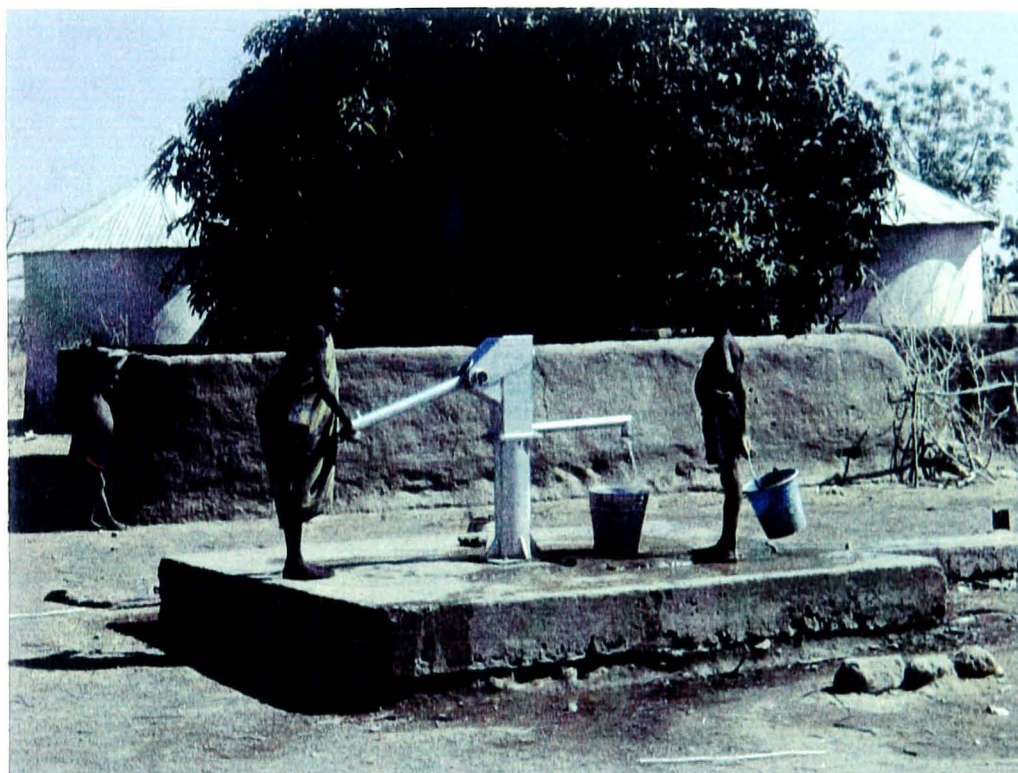

Already it is clear how this lifestyle and environment must influence the disease profile and epidemiology of the area. Ailments relating to poor nutrition and sanitation, like worms, malnutrition and diarrhoea are common. Dry dusty conditions promote skin diseases and acute respiratory infections. Malaria is still the leading killer; the priest's wife remarked 'how I fear it, it kills so fast, especially the children'. The region also suffers severe annual outbreaks of cerebral-spinal meningitis (CSM) (health centre administration records, 1995-6). AIDS and STDs are low in comparison to more immediate food and water related illnesses, but they are probably under-reported. The District Director feels such diseases are an increasing problem, exacerbated by illegal mining activities in the area:

'It's an emerging problem. Looking at the mode of transmission and the lifestyle it could become one of the leading causes of morbidity and mortality...With the mining, I can't speculate but we imagine there is indiscriminate sexual activity...we know there is high promiscuity and that by itself can increase the risk of HIV infection'

District Director of Health Services, Bawku West District, 1997

Polygamy is the usual form of marriage and in addition men, particularly those travelling to earn money, may have a number of girlfriends (Interviews, Binaba-Zongoire community members, 1995-7; Anarfi 1993; Anarfi and Awusabo-Asare 1993; Fayorsey et al 1994). Focus group discussions held in the villages uphold findings elsewhere in the country, that while there is some knowledge of HIV/AIDS, knowledge about STDs is much more limited, and there are still risk behaviours which have serious implications for STD and HIV infection.

4.1.2 Actors in the Sub-district

Sub-districts are communities. While district identities may be considered ambiguous and artificial⁵¹, sub-districts, being so much smaller, encompass village communities whose identity remains intact. Above the village level though, district actors overlap considerably with those of the sub-district and 'big men' at the sub-district (who are big men from their local communities) are often also players at the district too. At these levels the cast of actors involved in health issues is much broader than at regional and national levels. In Bawku West the links between different local, ministry, municipal, NGO and church groupings are quite fluid. Even where there are no formal links between groups, personal links mean information can be spread, although the active involvement of community members in areas like health depends, as anywhere, on the motivation of individuals.

Links between the Ministry of Health and community members sitting on the locally elected District Assembly are ensured through the District Medical Officer (DMO) who sits on the District Assembly social sector sub committee which meets quarterly. The District Assembly has resources which could be tapped by the Ministry of Health under the decentralisation

⁵¹ District boundaries are often changed for political or administrative reasons. People are therefore often wary of investing in a district identity which seems far removed from their daily lives. One District Assembly man remarked: 'people don't see what value the district has for them...you have to dash them pitou [local beer] before they'll listen.'

policy, but they are ambiguous. The 1997 estimates give health 9% of the District Assembly common pot, but expenditure on health depends on the activity of the DMO in lobbying for district funds in competition with other district needs. Long delays in receipts and budget approvals make district-level planning very difficult. In Bawku West, proposals have recently been put forward by the new DMO for health education activities. The 1996 District Chief Executive report stresses the need to decentralise the health delivery system in the district so that people should not have to walk more than 6 miles to a facility and to ensure that each facility is properly stocked with equipment and logistics. Many feel this is lip-service only and no funds have been allocated:

'I doubt they have funds for these health issues. They feel they must say it to please the people.'

Health committee member, Binaba

The Bawku West District health management team (DHMT) has actively co-opted members from a number of key NGOs working in the area, as well as representatives from other sectors like Agriculture and Education, and they meet monthly. Sub-district committees are supposed to have been set up, but this has so far only happened in Binaba-Zongoire sub-district where many of the DHMT members are based (Interviews, Binaba medical officer in-charge, Anglican Church members and District Assembly men 1997). In Binaba-Zongoire, there are also a number of active local groups; some are part of the municipal local government structures, others are voluntary. The links between all these players are shown in the organogram below.

Figure 4.6 Organogram of Actor-liaisons in Bawku-West District and Binaba-Zongoire sub-district

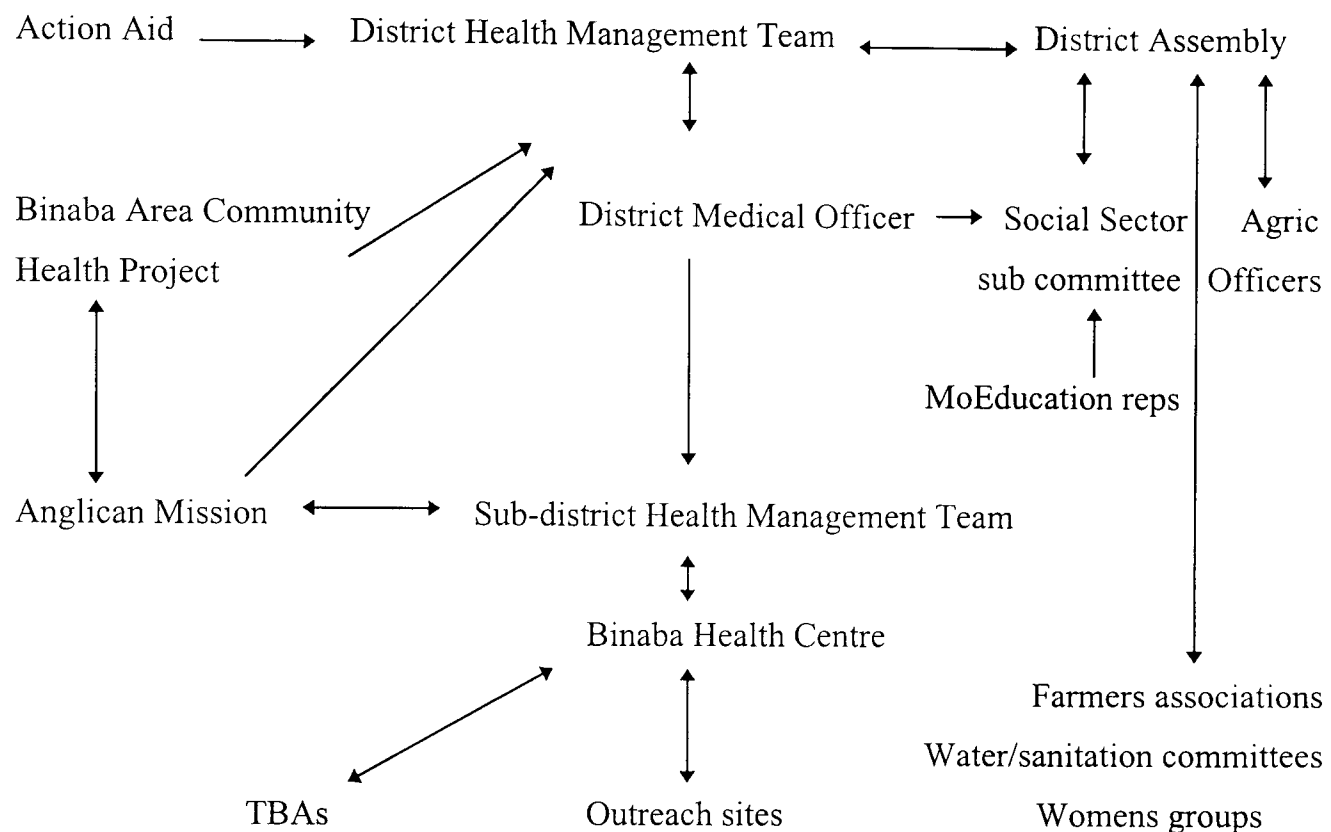

In Binaba-Zongoire, one is struck by the active presence of the Anglican church. It is probably the single most active body in terms of health and general development. Such widespread church involvement is typical of the whole region which is scattered with Presbyterian, Anglican, Catholic and Islamic missions supported both from within Ghana and from overseas. Ghanaian 'priests' are usually local men, often highly regarded within the community and actively involved in the various civil committees at sub-district, district and regional levels. As a result they are usually very aware of local affairs and often serve as focal persons for NGO as well as municipal projects (extensive interviews and personal observations, Church leaders, NGO representatives and local residents 1995-7). In Bawku West two NGOs, Action Aid and BACH both work closely with the church. The specific health sector inputs of these and other actors are commented on at the relevant points throughout this chapter.

In summary, people in Binaba-Zongoire live in basic subsistence conditions with high incidence of pre-transitional diseases. Communities are small though scattered; local leaders and big-men are well known and are involved in a variety of sub-district, district and regional

activities. They have close links with a number of NGOs and religious organisations working in the communities.

4.2 HEALTH SERVICES AVAILABLE

Official numbers of registered health facilities in the district vary⁵² between 6 and 10 facilities including community and mission posts (Regional Administration data base, 1995; UER 1995 Annual Report; 1995 Regional Hospital Annual Report). There is a health centre in the district capital, which is in the process of being upgraded to a district hospital. The highest ranking health personnel is currently a medical assistant, but there will eventually be a doctor attached. The other main health facility is a health centre in Binaba, the main town in Binaba-Zongoire sub-district. Binaba-Zongoire has a total of two facilities: Binaba health centre and a church supported community clinic in the village of Yelwoko staffed by a nurse midwife on secondment from Binaba health centre. The Yelwoko nurse refers all cases requiring the attention of a medical assistant or doctor to either Binaba health centre or the health centre at the district capital, Zebilla, or to the hospitals at Bolgatanga or Bawku. The District medical officer is a practising medical doctor and calls in, irregularly⁵³, to Binaba and Zebilla health centres, although his activities are largely administrative (Interviews, DMO, Binaba health staff, Binaba and Yelwoko community leaders 1997). It is the health centre at Binaba which provides the focus for the sub-district service delivery analysis in this chapter.

4.2.1 Binaba Health Centre

The Binaba health centre is typical of many clinics and health centres in the region: a compound of three or four separate buildings. The clinic opens from 8am until 1-2pm, with a nurse remaining on call 24 hours. Most people in the surrounding settlement know where to find a member of staff in an emergency since there is staff-assigned accommodation on the compound and in this small community nurses are well known. There are seven staff: a Medical Assistant in-charge; a public health nurse; two community health nurses (working in shifts); two nurse midwives and a disease control officer.

⁵² Official figures are inconsistent largely because of poor data management. See Chapter 6 for a more detailed analysis.

⁵³ Like many District medical officers, he does not live in the district but in Bolgatanga, the regional capital. His time is split between medical practice as the most senior health practitioner in the district, and administrative duties which require him to attend numerous district and regional level meetings.

On a non-market day, the centre is quiet except for the group of women, children and cows at the bore hole behind the maternity block. Some do their washing there and bright cloths are spread on the broken wire fence which is supposed to stop the cows from wandering in. In view of the bore hole is a small two-doored building - the urinals, used by men and women. There are no toilets.

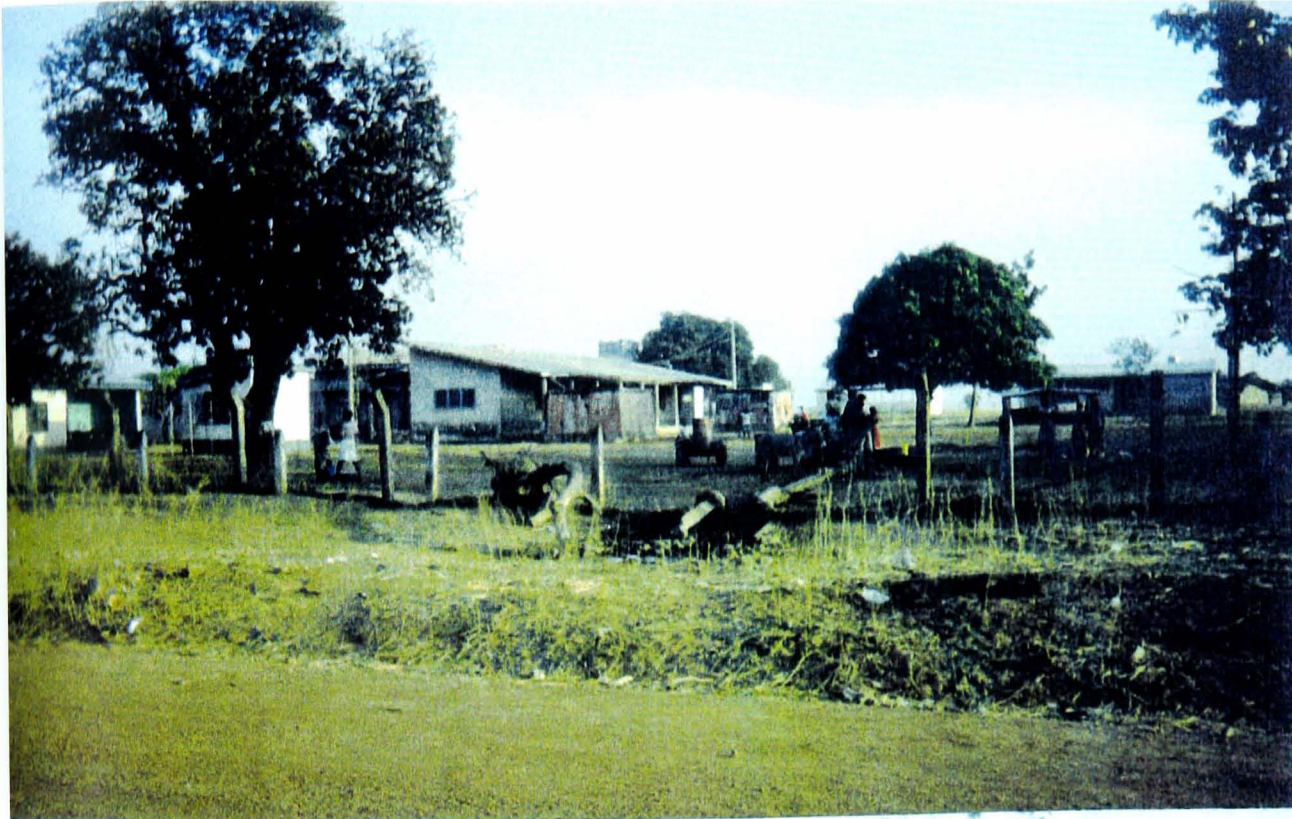

Figure 4.7
Binaba
Health
Centre and
Compound



Figure 4.8 The bore hole providing water for the Health Centre and the townspeople

Near the urinals is the first building you come to as you enter the compound - the maternity block. A small building with peeling, red dust-stained white paint (like all the others). It is staffed by two nurse midwives, working in shifts. If you go in, you enter a corridor with a desk and benches, where consultations with ante-natal clients take place. There is no privacy for verbal screening for STDs. Off this corridor, there is a delivery ward. At the end of this is a small private examination room with a sink and a couch which could be used for vaginal examinations. In practice, the midwives say STDs are rarely seen and they always refer them at the orders of the medical assistant who says:

'Sometimes maternity were seeing ANC cases with gynaecological disorders and they didn't know we should record them so they didn't refer them but treated them there. So I told them, if they see such cases they should refer them to me and not treat them there.'

MA, Binaba health centre



Figure 4.9 Examination room in the maternity wing

On a typical day, there may be a pregnant woman in the ward who has been admitted with malaria or pneumonia. The outpatients building is opposite. This is the main block which includes the consulting room, an injection room, the medical records office, and a dispensary.

Linked to the outpatients block by an open, roofed corridor, are an office for administrative work and the lying-in ward where a woman may have just delivered and be preparing to walk back to her village.

Figure 4.10
The Injection room
and Registration
desk



Figure 4.11 Malaria patient on a drip
in the Consulting Ward

There may be several clients waiting on wooden benches outside the consulting room which is screened by a curtain. Typically they may need sores dressing, have come with respiratory problems or suspected malaria. There are rarely more than half a dozen clients waiting at any one time, except on market days. On market days, the staff themselves are often in the

market, and clients may have to wait or return later. One of the nurses on duty (or sometimes the records officer) sits at a wooden desk outside to receive client record cards. The medical assistant in charge of the health centre sees all medical cases including STDs. These may be referred from other units in the centre. Similarly from out-patients, clients may be referred to the ante-natal care building, or the family planning/child welfare building. If the medical assistant is away, clients will be seen by one of the nurse midwives who may ask them to return to see the medical assistant, or refer them to facilities at Zebilla (12 miles away), Bolgatanga (30 miles) or Bawku (35 miles): each between 2-4 hours travel by public transport, excluding time spent waiting for a vehicle.

The final building of the health centre is the family planning and child welfare block, a stone's throw across a small ridged field. On our typical non-market day, three mothers are sitting on the benches in the covered courtyard of the family planning area. Talks and advice on child nutrition, malaria, family planning and sometimes AIDS are given here by a community health nurse who draws on the blackboard at an end wall. There are a few posters on the walls about malaria, malnutrition, family planning and the National Immunisation Day (Polio). On market days groups of 20-30 mothers might come for child welfare (weighing and nutrition checks) and sometimes family planning and other general health problems. The FP consultancy room is private, with a wooden door which is closed during consultations. It has an examination couch and a sink.

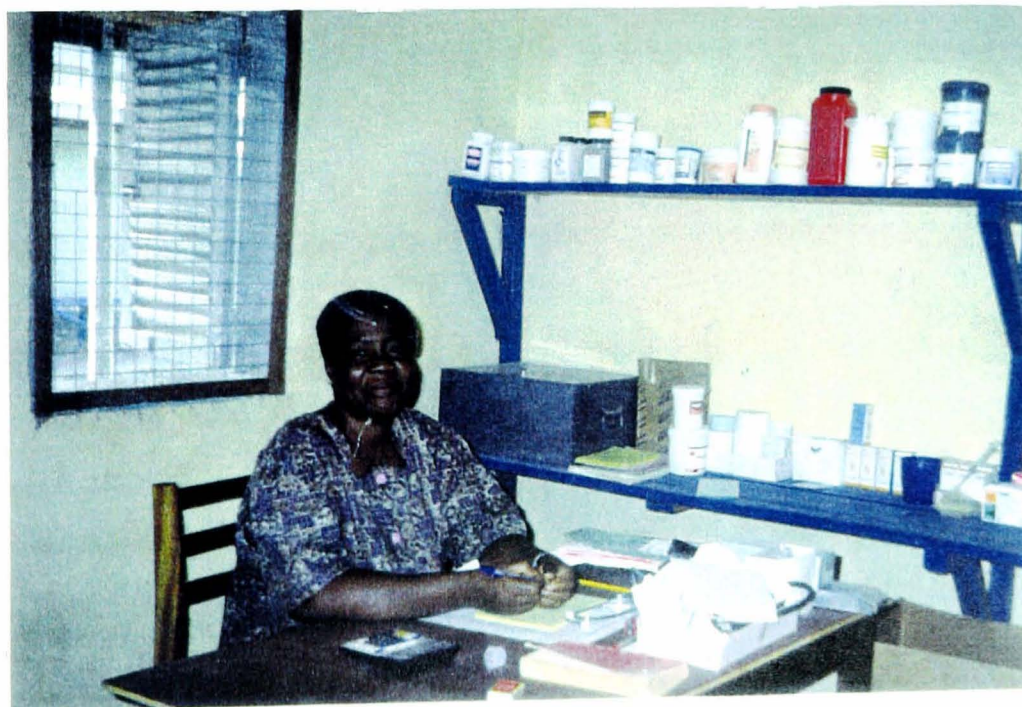

Figure 4.12 Dispensary

Figure 4.13
Child Welfare
Unit



The public health nurse has some knowledge of STDs and is a trained AIDS counsellor. She says she occasionally sees STDs, but cannot treat them:

'We refer them all to the MA or to Doctor [DMO] if he's around...We have only chloroquine and paracetamol here, for everything else we have to refer.'

Dusk falls between 6-7pm. The health centre has no electricity, but a generator supplies it with light for about two hours each evening. Because there is no regular electricity supply, drugs and supplies, which are obtained from the District Medical Stores at Zebilla, about 12 miles away, are kept in a kerosene fridge.

4.2.2 Outreach, health education and alternative health care

Utilisation of the clinic is low. To improve access to health care for villagers, outreach for basic primary health care including ante-natal and family planning services, covers seven villages in the neighbourhood on a monthly basis. There are 18 villages on the list, but unless funds are given for special outreach activities there are not enough resources to cover them. In the dry season when the 'roads' are passable, two health centre staff go out on a motorbike with a box of drugs and basic provisions. During the rains they go when they can. The public health nurse goes if she is in Binaba, together with a community health nurse or the disease control officer. The latter two (who are not 'professional' medical cadres) go alone if the

PHN is away. The health centre staff agree on the value of community education, but it is not a district priority and is severely 'hampered by lack of funds':

'Any health worker, to get to Zongoire, needs means [transport]. The MoH did not agree to give funds to the DHMT for means [transport] for education.'

Sub-district health committee member, 1997

Even when transport is available and the roads are passable, mobilising villagers to attend the outreach sessions is often problematic. Village health committees⁵⁴ (where they exist), or community leaders are informed of the health centre's outreach roster and are supposed to mobilise villagers to attend, but they often require incentives and collaboration has lapsed in recent years:

'It's a long time we haven't met them, but formerly we have given them refreshment. For the polio one [National Immunisation Day] we gave them lunch.'

MA, Binaba HC

Church leaders and district assembly men believe that for health education 'the most effective way is not talking but a video show and drama' and the activities of the local NGO Rural Help Integrated were cited as examples of this (Interviews 1997).

Markets are good places for putting out health education messages. Sometimes an MoH van (from the regional headquarters) will drive round the markets (all the main ones in the region are accessible by primary or feeder roads which usually remain passable throughout the year) with a mega phone to educate on specific outbreaks or activities e.g. meningitis, cholera and National Immunisation Day telling people how to recognise the symptoms and where to go for treatment. A man attached to the Binaba Area Community Health project⁵⁵ plays a fiddle in Binaba market and sings songs about the dangers of AIDS.

⁵⁴ The status of village health committees is ambiguous. They were for a long time part of the primary health care set-up in the 1970s but fell out of favour in the 1980s and lapsed through lack of support. Now there is a move to reinstate them; some have been set up by government, others seem to have sprung up of their own accord, often under the auspices of NGO or church activities.

⁵⁵ BACH is a local NGO running community health initiatives such as well-digging and sanitation education. It is supported by a Swedish mission NGO, DIAKONIA, Oxfam and British Water Aid.

When villagers are mobilised to attend an outreach site, the outreach team does not necessarily arrive - because the vehicle is broken or there is a lack of vaccines or the nurse is sick and so on. In one incident at Yelwoko village the nurse at the community clinic had successfully mobilised mothers to come for a monthly immunisation session by the outreach team from Binaba health centre. Many women had walked miles to bring their children only to be told to go home again because the vehicle never arrived. 'They have disappointed us' said the nurse, but it is a common scenario (Interview, Yelwoko NMW 1997).

The polio-outreach programme (billed as 'National Immunisation Day') was very successful, because it was centrally, vertically funded by UNICEF and money was given to each district and sub-district specifically to mobilise populations, to give incentives (food and drink) to their leaders, to ensure supplies of vaccines were in place and that transport was available and working. Special committees were set up to enlist the support of key community members. In Binaba the Chief's brother was involved together with a number of teachers and health staff. People were promised, and given, lunch.

Without support of opinion leaders and, especially, without 'dashes'⁵⁶ and incentives, villagers are not prepared to make the effort to come to the clinic or outreach point for immunisation or treatment. The reasons are complex as an investigation of community disease priorities will show (see chapter 5).

If people do not go to the health centre or attend outreach clinics, they may buy simple drugs at Binaba's single drug store near the market place. Chemical soap, paracetamol, oral rehydration salts, chloroquine, penicillin injections and some general anti-biotics like tetracycline are available. For any other drug, people have to make the four hour trip to Bolgatanga, usually on market day when market trucks provide transport. Market days are always crowded: village women go to sell produce and men go to socialise and drink, and carry out any business transactions they may have. There are a number of traditional healers, though analysis was not made of them and their numbers are unknown.

⁵⁶ The word used for a financial or material incentive which may either act as a bribe, or as a gift of thanks. They are often expected for example in market transactions, or if any non-routine action or work is required.

One can summarise the health options for Binaba-Zongoire succinctly: local facilities are poor and there are few alternatives without time, transport and money.

4.3 SERVICE DELIVERY AND UTILISATION: SOCIAL COMPLEXITIES

Thus far the thesis has indicated a number of clusters of factors which interplay to affect service provision: factors which also affect service utilisation. This section explores the interaction of resource and structural constraints with social-behaviour factors to show with greater clarity how complex the influences, particularly of the latter group, are on service delivery and utilisation.

There are two groups of social-behaviour factors particularly prevalent in Ghana. These can be termed ‘status-hierarchy’ issues and ‘familial/social obligation’ issues. Each is manifested in a variety of behaviour which affects service provision and utilisation. Such behaviour can be interpreted as both a cause and a function of poor services.

4.3.1 Concepts of hierarchy and the culture of status

*‘In Ghana...there is a clearly defined social hierarchy which spans all parts of the country’
Nugent 1996:34*

The idea of a ‘culture of status’ was introduced in the previous chapter when it was seen in the hierarchies of clinic staff. ‘Big men’ status has been noted in discussion on the sub-district actors. It is seen in all walks of Ghanaian life (Nugent 1996; see also chapters six, seven and eight) and has implications for provision of services and the way services are seen and used by the community.

The impact on STD treatment whereby only the superior is allowed to treat has already been seen in chapter three. When the superior is not on site, nurses either treat themselves or refer to a different facility at their own discretion, which will depend on their training and experience. In Binaba health centre, when the medical assistant is away the public health nurse might treat cases in the family planning centre, but the nurse mid-wives who would take over the out-patients section do not have any substantial training in STDs and prefer to refer. This has obvious time, cost and emotional implications for clients presenting with an STD.

Health staff are professionals; they are often isolated from their families and peer and status groups, often posted to villages where a different tribal language is spoken. As a result, they may flaunt their superior social position over the generally poor and illiterate villagers. Staff of all levels may be disparaging to clients, especially children and illiterate villagers, particularly women (personal observations and informal conversations 1995-7). Some Ministry of Health collaborative research projects have documented similar problems relating to staff attitudes.⁵⁷

4.3.2 Familial and social obligations: an economy of affection

‘The traditional communal system is essentially socio-ethical’ (Gyekye 1995:96). Within this framework, the family itself is held sacrosanct as ‘a social as well as moral value...It is the responsibility of every member of the family to seek and maintain the cohesion of the family’ (Gyekye 1995:75). Tonah, in a lucid analysis of agro-pastoral communities in the Upper East, refers to an ‘economy of affection’ whereby nepotism as well as family sharing of resources, are part of family survival strategies (Tonah 1993:150). Clearly this creates a tension between professional and family needs, especially in rural areas where, as a professional, the health worker may be accorded a particularly high status. In the light of this, can be understood the frequent absence of health staff to attend to ‘family matters’, or the bestowing of favours (in terms of treatment priority or waiving of medical fees) on relatives, which might otherwise be perceived as a lack of dedication towards, or professional conduct within, a job.

So, for example, if news comes to one of the health centre staff that a family member in another village is sick, or has died, or is to get married, they will leave immediately, usually for a period of several days, sometimes for several weeks. The lone nurse midwife staffing a community clinic in one of the villages received a message from her village (in a different district) that a family member was sick and asked for permission from the Church (to whom she is responsible) to leave for several days saying ‘if I don’t go now they will think I don’t care’ (personal communication January 1998). In her absence the clinic ceases to function. There are frequent complaints that the medical assistant of Binaba health centre is difficult to find. If a meeting is called or someone has to be seen in another town relating to a family or farming matter, the medical assistant will take time out of clinic hours to go and sort it out.

⁵⁷ see for example “Should the Nurses be Blamed?”, Ghana Medical School/MoH, Richardson et al 1992; “What does the public want from us?”, Dovelov et al (MoH) 1992; “Quality of Care in Government health institutions in Eastern Region”, Liverpool School of Tropical Medicine/MoH, 1994.

This is in addition to the disruption to clinic activities caused by training sessions already noted.

4.3.3 Issues of infrastructure and non-residency

The medical assistant in charge of Binaba health centre cites lack of infrastructure, light, staff and transport as the main problems it faces. All senior staff at Binaba Health Centre echoed this, citing the degradation of the facility as well as the poor quality of housing in the town (no piped water, no electricity, poor road access and communications) as reasons for not attracting sufficient staff there (Interviews, Binaba health centre staff 1997)⁵⁸.

There is insufficient funding from central government for infrastructural development and the capacity for internal District revenue generation is low (MoH and District Assembly Budget documents 1996-7). District Assembly funds could be tapped for such activities, but some feel the district has other priorities, notably in developing the main township where most senior local government men are based (Interviews church leaders 1996-7). Poor use or mis-management of funds are also a problem. A church leader comments 'Money is there but it is used wrong' (Interview, Ayindana 1997). The church has in the past provided considerable support for transport and drugs procurement for the Health Centre, but there was no accountability for the funds given and church leaders have felt powerless to intervene⁵⁹, leading to the comment:

'the only way out of this problem of misuse is to channel [money] through NGOs'
Church leader and health committee member

Non-residency is a major problem in the remoter sub-districts where facilities and standards of living are poor. Neither the current nor the former district medical officer (the only medical doctor in the district) is resident in the Bawku West district at all, but in the regional capital Bolgatanga which is nearly two hours drive from Binaba.

⁵⁸ The state of medical buildings and staff accommodation is a problem all over the region. The regional hospital report of 1996 records that 'the state of staff housing is deplorable' and '[i]t is therefore needless to say that this is the more reason why qualified personnel are not attracted to the hospital...' (GMOH(UER) 1996b:16). The report also cites scarcity of medical officers, lack of fencing of the hospital compound and unsafe electrical wiring as major problems.

⁵⁹ A fourwheel drive vehicle was acquired for outreach and ambulance services which was appropriated by the then District Medical Officer for his personal use; two million cedis were donated for drugs which to date has not been accounted for. There are still drug shortages at the health centre.

'This Dr [District Medical Officer] says he has no electricity or running water and he can't move his family there [Bawku West].'
Action Aid programme manager, 1997

The Reverend Father in Binaba, says the church really became involved with health service provision in response to growing complaints by parishioners that health staff neglected rural areas, preferring to take up posts in the towns⁶⁰.

Working in difficult conditions with low and erratic pay, poor living conditions and separation from families, many staff find solace in social activities - even during 'work' time. Binaba town is small and all things are close; if there are no clients still waiting at the health centre by 11.00am or noon, it is common to meet one of the clinic staff at the local pitou bar⁶¹. Should they be needed back at the centre, someone will call them. This is not a problem in itself since the workload is sometimes very slight, but it can have a detrimental effect on the way the health centre and its staff are viewed by the public who may see them as not serious about their work and it could act as a disincentive for clients who may not make the effort to come if they know the staff may not be on site (Interviews, church leaders 1997; informal interviews with community members 1996-7).

4.3.4 Absentee-ism and Activity paralysis

Whatever the causes, the main consequence of non-residency and absenteeism, especially of senior staff, is the activity paralysis it leads to because staff refuse to take decisions without the sanction of their superior. This is again a function of the cultural attitudes already seen at district level, where seniority gives status which is to be respected and cannot be side-stepped, therefore decisions must not be taken without the knowledge or approval of the superior (personal observations 1995-7; interviews and personal communications 1996-7; Nugent 1995; see also chapter seven for discussion of ideas of 'status' and control).

Action Aid, which runs a number of programmes in Bawku-West district, is openly critical about such attitudes and behaviour within the MoH, describing their working relationship with them as 'quite a problem' (Interview, Action Aid programme manager, Bawku, 1997).

⁶⁰ Fr. Anyindana personally approached the district health management team and was made a co-opted member of the sub-district health management team where he began lobbying for health talks to be launched in the villages. As a member of the District Assembly, he also lobbied for district assembly funds to be used to support health sector activities.

⁶¹ Pitou is a locally brewed beer made from millet or guinea corn.

The (Ghanaian) programme manager's comments exemplify some of the problems caused by these status hierarchies:

'We've a peculiar problem in [Bawku West] where there is no resident medical officer - he works from Bolga. We go in to do something and the nurses say "oh, no, no, we can't do this because the boss is not around." It's very frustrating...We even had it for the training of the TBAs [Traditional Birth Attendants] in Zebilla. We know there are competent nurses there who can do it, but the regional Public Health Nurse is in Bolga and she has to give the go ahead.'

Action Aid Programme Manager 1996

He says the only hope for improving staff residency and commitment levels is 'if facilities are there to attract them to the districts...it's essential that they [the health personnel] are physically there all the time.' (Interview, Action Aid 1997).

4.4 SUMMARY

The lessons from this chapter are essentially threefold:

- Lifestyle and poverty factors affect disease profiles, health service options and service utilisation.
- Socio-cultural and behaviour factors help to explain poor service delivery and low service uptake.
- The effects of social-behaviour factors could be reduced through improving the physical, clinical and management constraints, but where they are a function of socio-cultural structures and norms, they may continue to impede service provision and policy implementation.

In addition, a number of specific points can be summarised:

- Networking between MoH and NGOs/churches involved in health is good at district/sub-district level but resources are limited.
- Health services in the rural sub-district of Binaba-Zongoire are limited and poor.

- ‘Status’ and ‘hierarchy’ permeate the whole society influencing staff willingness to operate without a superior on site, staff attitudes to clients and women’s access to health services without the consent of a male.
- Traditional systems put great value on family support creating tensions between family and professional obligations.
- Concepts of hierarchy, status and familial obligations result in staff absenteeism, activity paralysis and decreased quality of services.
- Quality of service provision is also influenced by structural deficiencies creating difficult conditions of work which contributes to staff feeling undervalued.
- Poor scattered communities experience significant access and cost constraints to utilising services which are under-resourced.

We have seen the contexts in which villagers live, and some of the service/provider-related factors influencing service uptake. The social-behaviour factors illustrated in this analysis indicate how important they are in influencing staff attitudes and practices regardless of structural and clinical/technical issues. These alone, however, do not entirely explain low service utilisation. Some of the earlier discussion has hinted at broader reasons for low utilisation, with roots in how the communities perceive disease and what their concerns and priorities are. The final layer of context and explanation lies within the communities themselves - with the social-cultural contexts in which they live their lives, are sick and seek help. The next chapter turns to examine communities’ own comments and ideas on health and illness, to draw closer to understanding what drives them to seek health care and what sexual diseases really mean to them.

CHAPTER FIVE

COMMUNITY CONTEXTS: COMMUNITY ATTITUDES AND BELIEFS

'...culture constructs the perceptual, explanatory and behavioural options that individuals have at their disposal for understanding and responding to illness.'
Kodjo A. Senah, 1997:208

This quote speaks of the influence of 'cultural' factors on the utilisation of services; it has especial relevance for reproductive/fertility related services. While I make no claims to providing a comprehensive definition of, or guide to, 'culture' in the Binaba-Zongoire subdistrict, this chapter does attempt to shed light on the variety of these socio-cultural factors which influence service utilisation.

Neglecting local cultural and religious beliefs and practices often leads to inappropriate programme design and implementation and fails to address the problems it was intended to. There is considerable literature on the ability of communities to define their own problems, which policy makers, despite the 'community participation' rhetoric currently in vogue in the donor and national policy making arenas, seldom take into account (Oppong 1989; Lane and Meleis 1991). What do the people of Binaba-Zongoire consider to be their health-seeking priorities and what are their ideas about STDs and HIV/AIDS?

This chapter is devoted to the perspectives of communities from villages in the Bawku West district: their social-cultural interpretations of their situations. The analysis presented here suggests that there are a range of community-level factors affecting service uptake which current services are often insensitive to or are unable to address. Consequently STD and health management strategies need to be wider than health-sector. Community perceptions of disease and disease priorities are analysed in the first half with some indication of NGO and church roles in addressing these. The second half considers the social/cultural sexual and reproductive 'norms' relating to sexual attitudes and behaviour, again indicating where NGOs and churches are involved.

5.1 DISEASE PRIORITIES AND SEXUAL HEALTH

'The logic of people's ideas about health and illness, sexuality, pregnancy and birth can not be neatly separated off from the complex of other ideas that motivate and inform their lives.'
Rose, 1995:8

5.1.1 Disease priorities: fundamentals of health

'Hunger too is disease'
Interview, Anyindana

Health, in the Upper East, is viewed in its widest terms. The first priority of people is food and water and this is manifested in their spending and investment priorities. According to a prominent District Assembly member, health, agriculture and education, in that order of importance, are the main topics discussed at assembly meetings (Interview, Appiah 1997). In his interpretation, 'health' includes food and nutrition concerns, and water and sanitation issues. Lack of potable water and scarcity of food are the two major health problems cited by district assembly and other community members. Other than these, the main perceived community health problems are malaria, measles, malnutrition, worms and meningitis (CSM) (Interviews with District Assembly men, church leaders, Health Centre staff and community members 1996-7). Official reported STD cases only amounted to about 250 for the Upper East in 1996, and AIDS cases were 575 (GMOH (UER) 1997; GMOH 1997) although the 'guestimated' cases were 1 900 and 490 respectively (see Figure 6.5 chapter six). Certainly STDs are not 'seen' in the same way as the other ailments cited in community focus groups.

To address the main community-defined 'health' priorities, household and community spending priorities lie with food production. Extensive informal conversations with community members, many of them farmers, revealed that while they would be willing to spend C40 000 on a sack of fertiliser (usually paid for through some kind of co-operative group) since this is seen as securing food production which invests in the future well-being of the whole family. C400 for a bar of soap or C1 500 for childhood vaccinations, however, is considered too expensive (Interviews with community members and farmers groups representatives 1997). Household incomes are notoriously difficult to clarify (Ghana Living Standards 1994; Senah 1997). In the villages of the Upper East where the population relies on subsistence farming, it can be assumed that there is very little 'surplus' cash and poverty there can be defined as absolute. The table below gives an indication of comparative costs of selected medications, food and household items and typical wages of common professions.

Table 5.1 Comparative costs of selected items in Bolgatanga, as at end 1997.

Item	Price (cedies) C3 500 = £1
Sack of groundnuts	40 000
Sack of millet	70 000
Live guinea fowl	4 - 5 000
Calabash of pitou	200
Loaf bread	1 500
bar of soap	4 - 600
Chloroquine treatment for Malaria (10 tablets)	200
Paracetamol (10 tablets)	200
Tetracycline treatment for vaginal discharge (10 tablets)	500
Penicillin treatment for syphilis (10 tablets)	300
Condoms: each	30 - 50
packet of 3	150 - 200
WAGES*:	
Basic minimum daily wage for two earning adults	3 000
Teachers Salary (monthly)	120 000/ m
Nurses Salary (monthly)	80 000/m
Doctors Salary (monthly)	300 000/m
Cleaners Salary (monthly)	40 000/m

Source: Personal Observation; *IFH Consultancy Report 1996.

Getting to the health centre is perceived to cost time and money which may simply not be available. Even if drugs are free, as under the TB treatment programme, clients may still not come because of time and transport costs (Interview, Binaba PHN, 1997). The traditional birth attendant who translated the male focus group discussions, said women from his village, just 4 miles from Binaba Health Centre, are still reluctant to take their children there for immunisations or other health care because they will have to buy food for them since they will be hungry from the walk (Interview, Abas, 1997).

In the Upper East, women's financial access to services is more limited than some communities elsewhere in the country⁶². Navrongo research centre findings indicate that females in Kassena Nankana district have virtually no say in household expenditures and very limited access to money (Adongo et al 1998). Interviews with the leader of a women's income generation project in Yelwoko village suggest the situation is similar in Bawku-West.

⁶² Where tribes, like the Akan, are matrilineal, women often have more financial autonomy.

The impact on health behaviour of people's every-day experience of poverty can be more subtle. When, for example, life-expectancy is low and acute poverty makes hunger the first priority, the use of contraception seems either misplaced or irrelevant:

'Some don't care, someone said to me "well, I might be wearing a condom and a block might fall on my head", they still go on in ways that are dangerous. Many young people really don't care - they are more concerned about getting food that day than catching HIV...They are not worried about something that might come out in several years time. That makes it more dangerous.'

SMO, Navrongo hospital

Health in terms of wider 'developmental' issues cannot really be expected to be addressed by the Ministry of Health. A number of NGOs and religious organisations do play a vital role in addressing many of these locally defined priorities.

The Binaba Area Community Health project (BACH), an NGO with funding, resources and technical assistance from several non-government organisations, operates in a number of surrounding villages, running farming loan schemes, encouraging the building of latrines, the digging of wells, and general education on environmental health, water and sanitation issues, nutrition and personal hygiene. Its staff give occasional AIDS talks to community groups, but these are not a priority. The Agricultural Extension Officers, the ground corps of the Ministry of Agriculture, are also involved in giving educational advice on water and sanitation issues as well as advice on crop production and pest control. At one time they also distributed condoms, but due to lack of follow-up and incentives this has lapsed. The only international NGO operating extensively in the district is Action Aid. It has funded a number of AIDS awareness activities and community mobilisation efforts.

5.1.2 Perceptions of sexual diseases and reproductive health

Although spending and health seeking priorities lie with malnutrition and water related diseases, sexual and reproductive health is fundamental to the societal status of both men and women in Ghana. Because of this, sexual issues are considered highly important but sexual diseases are very taboo.

For sensitive policy areas like STD and HIV/AIDS management, understanding how communities perceive STDs, HIV/AIDS and family planning, what their own health priorities are and how they perceive the service offered is vital for informed policy development. In this section the results of five community-level focus group discussions on these issues and interviews with various other community members and service providers are detailed. Since time spent at the community level was relatively limited and the respondent samples small in this research, references are also made to other research in Ghana, especially to findings from the extensive community health and family planning research projects being conducted by the Navrongo Health Research Unit among very rural populations in Kassena-Nankana, another district in the Upper East.

During time spent in communities between 1995-7, witchcraft was often mentioned as a cause of disease, even among people with secondary school education and among those with devout Christian or Islamic beliefs. There is a special village in the Northern region, just on the Upper East border, where women accused of witchcraft are sent to live in isolation. Sometimes they are beaten and even killed before they reach there (Interviews, Navrongo Health Research Centre staff 1995; personal communications 1995-7). Infertile women are particularly vulnerable to being accused of witchcraft. In an interview or focus group situation, people do not generally respond to questions on witchcraft because they think you as a white researcher will not believe them, or will look down on them (Personal communications 1995-7; Senah 1997), but extensive informal conversations with friends and acquaintances in the community revealed that these beliefs are widespread and deep rooted.

In traditional belief systems, illness can be supernaturally inflicted for wrongdoing or because of a curse inflicted by a jealous or wronged neighbour. Some illnesses including gonorrhoea are considered physical in cause and part of daily living, although Senah notes that in traditional thought it is 'the number of episodes or deaths occurring therefrom [sic] in each season that determines whether or not nature's course has been influenced by malevolents' (Senah 1997:141). Another Ghanaian researcher records interviews where gonorrhoea is mentioned as being 'caused by witchcraft, evil medicine or by contagion...In all three instances the fetish priest can cure them, but the doctor cannot cure the first two' (Fosu 1981:474-5). There is a considerable literature on witchcraft and its role in sickness and death in Ghana⁶³ which this present research cannot discuss in detail. Personal observations and communications reveal that fear of witchcraft and accusations of black

⁶³ See for example Twumasi (1979), Senah (1997) and Tsey (1997) for discussions of witchcraft in relation to traditional and Western concepts of disease and healing in Ghana.

magic have a profound effect on the way many rural Ghanaians, and even those with secondary education, interpret acute, strange or unexplained sickness including AIDS. It also influences the treatment options pursued, since spiritual causes require spiritual treatment (personal observations and communications 1995-7; Senah 1997; Tsey 1997). Ndubani (1997) notes the difficulties of categorising local disease perceptions. The presentation which follows is an attempt to understand the nature and diversity of local knowledge and beliefs about specific sexual diseases.

Perceptions of AIDS

People make no differentiation between HIV and AIDS and 'AIDS' is the term in common usage. There is considerable fear and prejudice towards people with AIDS (UNICEF-Ghana 1996). AIDS is commonly known as 'slim' or 'wasting disease' (focus group discussions 1997; Interviews with clinic staff and personal acquaintances 1995-7). Many focus group participants talked of how AIDS victims 'become lean'. There has been a major AIDS awareness campaign organised by the government and awareness of the existence of AIDS and that it is incurable, is high (1992 GDHS survey; Interviews and community focus group discussions 1996-7). Typical focus group ideas about the causes of AIDS included the sharing of blades, use of toilets, blood transfusions and injections unless they were given by a 'qualified doctor', promiscuity, and the risk of prostitutes ('Je-emilo' or 'Ashawo'). For male respondents, the burden of blame usually lay with the women:

'I've heard you get AIDS when someone is always a kisser of different women'

Male focus group respondent, Gore

'You shouldn't contact different women other than your wives because some women are getting AIDS.'

Male focus group respondent, Tetaku

'Most [AIDS] comes from the womens.'

Male focus group respondent, Tetaku

AIDS and STDs are often seen as ailments which are brought by incoming foreigners or acquired by those who have travelled outside Ghana - mostly to Burkina and Togo (the two countries which border the Upper East), and to a lesser extent Ivory Coast, and elsewhere.

Many providers especially in Bolga and Bawku where incidence is greatest, said they saw cases which they thought had been acquired in this way.

'They always come from Burkina - a lot of them across the border. Every market day [every three days] we see 2 or 3 cases.'

SRNMW, Islam maternity home

'AIDS is destroying people too much. Anyone who goes to Burkina Faso and comes, they'll bring it...there it is epidemic - three quarters of them have it there.'

EN, Sandema hospital

One male focus group respondent said 'I heard it came from Europe', a view also expressed in informal community interviews.

The most pervasive idea, was that AIDS can be supernaturally inflicted, through witchcraft or sorcery, although this was made clear predominantly through personal conversations. This points to a conflict in interpretation of AIDS as a disease, which has major implications for 'education' and 'awareness' strategies.

The AIDS awareness campaign in Ghana has failed to achieve any significant behaviour change (GDHS 1993; UNICEF 1996). This may be a direct result of the failure of western bio-medical approaches to understand the socio-cultural belief contexts of rural communities. AIDS is a socially stigmatised disease and those who have it are ostracised, often as people who have done wrong and are therefore being punished. To preserve self-respect and safeguard against potential social stigma and even rejection by the family, it is more acceptable for a person with AIDS to have the cause defined through traditional understandings of witchcraft or sorcery⁶⁴ (Rose 1995; personal communications 1995-7). A rejection of the bio-medical explanation of the disease can lead to a simultaneous rejection of the moralistic messages that typify government campaigns, which therefore have no impact on behaviour change. A background survey on reproductive health carried out by Save the Children Fund, which involved interviews with regional AIDS co-ordinators in all 10 regions of Ghana, found that when AIDS is considered supernatural in origin, messages like 'be faithful to your partner' will be responded to with comments like "well, you've got to die of

⁶⁴ See also Wallman and colleagues (1996) and Wallman (1998) for documentation of similar findings among women in Kampala.

something sometime” and “you can’t stop having sex” (Rose 1995:14). The report also notes that these differences in perception between communities and medical practitioners can lead to AIDS sufferers rejecting medical counselling and follow-up, again with implications for behaviour change (Rose 1995:14). An early AIDS counselling manual produced by the National AIDS Control Programme in 1991 recognises the challenge of traditional beliefs and sets out in a very sensitive manner how clients’ beliefs can be worked with rather than rejected (GMOH 1991). It gives the following example of an interaction with an HIV positive person who believes the disease is the result of witchcraft:

‘It’s possible someone may have put a curse on you. However, you know that there’s usually a means through which curses work. For this particular illness it works through having sex. The only way you can stop it working quickly is to stop having penetrative sex, or use a condom when having it.’
NACP training manual for AIDS counsellors, 1991

Reducing the social stigma of AIDS is one of the aims of the NGO Action Aid which is involved in Bawku West district providing support for AIDS-related peer education programmes and one-off AIDS awareness activities. For example, they funded a Durbah in 1996 which hosted plays and talks on AIDS and distributed free condoms.

Perceptions of STDs

Focus group discussions and community interviews revealed various local names for STDs. Women are usually blamed for STDs which are locally known as ‘women’s disease’ or ‘women’s sickness’ and nurses often use these terms when asking routine questions on FP/ANC cards: ‘do you have women’s sickness in your family?’. A variety of local names exist for the different symptoms, which are not necessarily STDs; these are shown in Table 5.2 below which also summarises the most commonly cited STDs, their causes and treatments.

Very few focus group participants admitted to having had, or knowing anyone who had, any STD symptoms except painful urination which many participants said they had experienced⁶⁵. Burning urination has a number of potential causes and is the most problematic to identify, in a focus group situation, as an STD. Schistosomiasis can cause this and is acquired through ‘unsafe’ water. Although Schistosomiasis prevalence has decreased

⁶⁵ The 1996 Ghana Situation Analysis also finds that burning or painful urination is the most commonly known STD symptom, possibly indicating that the STD aetiologies which can cause this (gonorrhoea, chlamydia and trichomoniasis) are the most prevalent in Ghana (GDHS 1996).

in the Upper East in recent years, it is likely either that some of the respondents had this condition, or that previously observed associations between dirty water and painful urination are still regarded as the reason for the symptom although the cause may now have changed. Cystitis is another cause of this symptom which can be cured by drinking plenty of clean water.

Table 5.2 Common local names, causes and treatments of STDs, Binaba-Zonguire, Focus Groups findings, 1997

STD symptom/name	Cause	Treatment
All STDs: 'Women's disease' 'waist pain'	various	various
Gonorrhoea: 'babaso' 'poabas' 'sangberima' (also 'bongdudumu' yellow features associated with jaundice)	Unknown Going with lots of women Curse Sharing towels/washing cloths	Root preparations, cooked and drunk or eaten Hospital as a last resort No treatment - die
White discharge: 'copelic'	Unknown Eating too much sugar	Unknown
Burning urination 'dundukukore' (literally 'it can develop into a disease if you don't check yourself')	Drinking 'dirty' water Eating too much young millet	Drink lots of 'clean' water, hot water, tea or herbal preparations
Sores 'sangberima'	Unknown Use of public toilets	Root preparations - lotions or baths Chemical soap to wash

Knowledge of discharge was far less; most participants had heard of gonorrhoea, or the local name 'poabas', and the two male focus groups recognised discharge as a symptom of this. The more widespread knowledge of the existence of gonorrhoea may be because it is the one STD which is named on government posters, and on TV/Radio and health workers' information and education propaganda. None of the female focus groups nor many of the male respondents could say how 'poabas' was caused. Other male group respondents said it was from women:

'People who contact with plenty women get plenty sores on the penis'

Male focus group respondent, Tetaku

'You get it through the women'

Male focus group respondent, Gore

Sores, white discharge and thick urine were all cited as symptoms of gonorrhoea. Several women from one group said there was no treatment and 'it normally leads to death'. They may have been confusing this with AIDS since AIDS and Gonorrhoea are sometimes targeted together in government education campaigns.

STDs are commonly believed to be acquired through curses, and through other communal habits such as the sharing of washing materials. These beliefs are encouraged by some medical practitioners, to avoid embarrassment and distress to the client who may be blamed, and stigmatised, for being 'promiscuous' (Interviews, health staff 1996-7). Formal and informal interviews with community members and health staff indicated that STDs are often seen as a sign of promiscuity and women in particular fear being accused and beaten by their husband if they are found to have an STD. Staff recognise the sensitivity of this issue for women:

'You have to be very careful, talking about sex is not easy, especially here...men will accuse you [the woman] of being the cause of the infection'

MA, Paga health centre

Once men have paid the bridewealth, women are considered their exclusive sexual property (Adongo et al 1998). Since women are considered to be the ones responsible for acquiring STD infections, they are assumed to have been the promiscuous partner and may be beaten for having violated the husband's rights over them.

For men, the stigma of STDs is different since they are not often seen (by other men) as the cause of the disease. Senah notes that in the traditional disease classifications of the coastal community of Southern Ghana where he conducted extensive anthropological research, gonorrhoea is a disease caused by daily living; by implication, it is a normal part of sexual adult life (Senah 1997:153). Significantly, in these traditional classifications gonorrhoea is considered a male disease - if a woman has it the connotations are very different. For men in the Upper East STDs are also considered somehow a normal or inevitable part of sexual life; certainly the stigma is different from that accorded to their women:

'STDs are not seen as a big problem. It's no big deal for a man to get Gonorrhoea - there are so many avenues for treatment. He can go to the drug store. The average man knows he get an injection of Spectomycin or

*Togamycin from a drug store or he'll go to the nurses in their homes,
secretly, or go to a so-called "quack".'*

Doctor, Navrongo hospital

The victim blaming and abuse surrounding STD and HIV/AIDS infections means that privacy of treatment for such diseases in a local community is paramount and the preferred anonymity of pharmacies and drug stores has been noted in Chapter four and in a number of health sector reports⁶⁶. One of the midwives at Binaba health centre, says it is common for clients to come and see her at her house - especially for personal issues like STDs or family planning. Problems remain however, for the infected individuals who do not use orthodox western health services.

5.2 SOCIAL/CULTURAL SEXUAL AND REPRODUCTIVE 'NORMS'

'In all Ghanaian ethnic groups, the sexual organs and their level of functioning are crucial determinants of one's status in the world. Their primary focus is reproduction. As highly pronatalist, therefore, Ghanaians focus a great deal on their sexual organs and the reproductive capabilities.'
Kodjo A. Senah, 1997:134

This section looks first at attitudes relating to sexual health, revealing aspects of sexual violence and male and female social-sexual identities. Then it looks at practices relating to sexual behaviour 'norms' and the use of family planning. An important caveat is needed before we continue. Gendered sexual relations are highly complex and are particularly susceptible to value-judgements made by western researchers. The following presentation attempts to record actualities rather than make prescriptive pronouncements on them.

5.2.1 Attitudes towards sexual and reproductive health

Reproductive decision making and sexual violence

Traditional gender roles and identities in Bawku West consist of gender stratifications which confer sexual and reproductive decision making powers entirely on men and severely restrict discussion of reproduction and family planning (personal observations; Interviews 1996-7; Fayorsay et al 1994; Adongo et al 1997; Adongo et al 1998; Kanna and Pendleton 1998). Women and children are the property of the corporate family-kin which militate against reproductive control (Adongo et al 1998).

⁶⁶ See for example the 1994 USAID report on Management of STDs in Ghana and 1997 HRU/CIDA report on pharmacists role in STD treatment (USAID 1994a; CIDA 1997).

'Even if she informs her man [about family planning], it is only the man who decides the number he wants. The woman has no say in determining the number of children he would give birth to.'

Navrongo discussant quoted in Fayorsey et al 1994:24

Violence as a result of accusations of promiscuity based on evidence of STD or HIV infection was noted in the preceding section. The Navrongo Health Research Centre has undertaken extensive community focus-group discussions which highlight the risk of violence against women over sexual relations and sexual decision making (Fayorsey et al 1994; Adongo et al 1998). Women cannot refuse a man sex because he is higher in status than her and once he has 'bought' her in marriage she is his property and must obey him (community interviews 1996-7; Adongo et al 1998). If she does refuse, the consequences are likely to be violent:

'...if he comes and wants her and she won't go he'll beat her.'

Female SRN, Wiaga

Focus groups conducted among male opinion leaders in Kassena-Nankana evidenced '...a profound lack of regard for women's opinions and concerns, and casual acceptance of domestic violence...' (Adongo et al 1998:1795). Discrimination against women is cultural and wife beating is considered a normal part of conjugal relations, among men and women and even the educated and church leaders (Fayorsey et al 1994; personal communications 1996-7; Adongo et al 1998).

Male domination of reproductive decision making and sexual violence are part of a highly structured social system. For married and unmarried women there are material benefits from sexual exchange relationships and these may be put at risk if they use family planning against their partner's will, or if they are found to have an STD infection which suggests a violation of male sexual rights (Adongo et al 1998; Ankomah 1998). Gender relations involve complex benefit systems where women acquire access to resources, children and identity through being 'owned' by their husbands⁶⁷. An Akan proverb states that 'a good wife is wealth'. As

⁶⁷ This is an area which warrants a great deal more research. Work at Navrongo Health Research Centre is beginning to unravel some of the complexities in the Upper East, though the material needs more sensitive handling than it sometimes receives. See also Ogden 1996 and Wallman 1998 for detailed, enlightening accounts of female sexual identities in Kampala in an era of AIDS.

such, the bride and her family can expect her husband to care for her total welfare (Gyekye 1995:82-3).

Pro-natalist rationales and the essence of womanhood

Since priorities lie with food production and securing potable water, family planning and reproductive health will not be priorities until the former have been addressed. The situation becomes more complicated when pro-natalist rationales are factored in. There are many well-established reasons for high fertility desires in sub-Saharan Africa which hold true in Ghana⁶⁸. An Ewe proverb states that:

'there is no wealth where there are no children'

Identity and community status for both men and women lies with having many children. Child mortality in Bawku-West, as the whole of the Upper East, is still high. Diseases seen to be killing children are the first health-seeking priorities and contraception is seen as an unacceptable risk of being left with no living children at the end of one's reproductive life (Adongo et al 1998; see also Caldwell and Caldwell 1987):

'Our people don't like spacing, because we are prone to all kinds of sickness and we can lose all our children in the twinkling of an hour, so we don't want to have few.'

DA man and Church priest, 1996

'...it is because our children are dying that is why we give birth to many children'

Female Navrongo discussant quoted in Fayorsey et al 1994:22

In the Upper East, large families are still synonymous with status. It is from children that both men and women gain identity, standing and respect:

'Big families in this culture are still prestigious...'

PHN, Sandema MCH clinic

⁶⁸ See for example the writings of Caldwell 1982; Mott and Mott 1985; Caldwell and Caldwell 1987; and Oppenheim-Mason and Taj 1987.

'Here the number of children makes your family heard, so the men are not much involved in family planning.'

StfEN, Bolga hospital

The influence of the family on fertility decision making has been noted. Another powerful aspect of this is the idea of lineage perpetuation required by traditional ancestral religions, which is highlighted in findings from the Navrongo research centre⁶⁹:

'Yes our ancestors will like us to have many children...'

'We want to have children so that our generation will not be lost...so that your name will not be forgotten after death, as we have not forgotten about our ancestors, forefathers and grandfathers.'

Male Navrongo discussants quoted in Fayorsey et al 1994:19-20

Various economic reasons for pro-natalist rationales are true in Ghana, but have been documented by many writers and are not detailed here⁷⁰. A remark by a young male school teacher, however, provides an interesting comment on the family-obligation system.

'If you have a job, relatives will be always asking you to help with their children's education and what and what, so it's better to have plenty of your own children so you can spend your money on them and not on someone else's children.'

Yelwoko school-teacher, 1995

So, for a wealth of reasons, the 'essence of womanhood' for women in Ghana lies with her ability to procreate. Her identity and social status is determined by the children she bears. In Oppong's research on roles of women in Ghana, most women cited their maternal role as their first priority and their source of greatest satisfaction (Oppong 1987). Childless women are pitied and even feared as witches who may be banished to the witches village in Gambaga (Senah 1997; personal observations and communications 1995-7).

⁶⁹ See also the works of Kritz and Gurak 1989; Caldwell 1990.

⁷⁰ For example Caldwell 1982; Caldwell and Caldwell 1987; Adongo et al 1998.

5.2.2 Sexual/reproductive behaviour 'norms'

Sexual networking and cultural practices: precedents for infection

Male sexual networking patterns have been documented in a number of studies in Ghana (Ankomah 1992; Anarfi 1993; Anarfi and Awusabu-Asare 1993; Ford 1994) and both male and female service providers in the present research commented on the sexual networking of men in the communities, saying they put many women at risk.

'Very few people will give up their partners...and talking about sex is taboo here'

Doctor, Navrongo hospital

Pre-marital chastity is not expected for men or women, but once married, women are expected to remain faithful (Fayorsey et al 1994:15). Indiscriminate partner change is limited to an extent by polygamous marriages. Village men in the sub-district focus groups had an average of 3-4 wives, and were less likely to go to partners outside these unless they travelled long distances. Younger men in the towns however, particularly those with the opportunity to travel, may have many more (Ankomah 1992; Anarfi 1993; personal observation and informal conversations 1995-7). Providers used their knowledge (and experience!) of male practices to advocate family planning to post-partum women 'so that maybe the men won't go out chasing' (Bolga hospital, CHNMW):

'You can't say after you've had a child, you want five years space [i.e. no sex] - the man will go out and come back with HIV. If you use FP you can keep him from going out'

StfNMW, Binaba health centre

Culturally, men prefer dry sex without anything which might inhibit feeling, such as condoms. As one male nurse elucidated, 'we like to go in raw and feel the friction!' (Interview, Bolga EN, 1996). Women often put herbs in the vagina to dry it before sex, increasing the risk of tears and wounds which increase susceptibility to infections (personal communications 1995-7; Adongo et al 1995 (unpublished)).

The incidence of female genital mutilation (female circumcision) in northern Ghana is also high, increasing the potential of tears and sores which raise the risk of STD/HIV infection (Knudsen 1994). The people of Bawku West are Kusasi and practice excision (the mildest form involving cutting off the clitoris and labia minora). It appears to be a declining practice

with only 25% girls now being circumcised although accurate figures are difficult to obtain and the reported incidence among some other tribes reaches 60%. A local education campaign, supported by Ghana Red Cross and Ministry of Health, is active in the region to raise awareness among the *wanzams* (circumcisors) of the dangers of unclean knives when the same traditional knife is used for many people.

These cultural factors potentially increase the risk of STD/HIV infection. Other than preventive education and sexual abstinence, the only way to decrease this risk is through condom use. We now consider in more detail the community views of contraception and condoms.

Family planning and condoms: community perspectives

Family planning is sometimes regarded by communities as government law and overtly political rhetoric on family planning and population control has been regarded with suspicion and distrust (GMOH 1992b:10). It is also seen in some areas as synonymous with abortion/sterilisation (Interviews, health staff 1996-7). In the Upper East the most widespread misconception seemed to be that family planning was something to end births rather than space them. In many of the local languages family planning is called ‘birth stopping’ or ‘you have had enough’ (‘Adogmake’) (Focus group discussions 1997; Adongo et al 1998; RHI report 1997). The private, Ghanaian NGO Rural Help Integrated (RHI) is attempting to address this by drawing together local opinion leaders (chiefs, elders, teachers etc.) and developing new names in the local languages to imply spacing rather than stopping (RHI annual report 1996; RHI report on community leaders workshop 1997). In the focus group discussions, many respondents said they thought it was for women who did not want more children:

‘It means when you born three or four times and don’t want the woman to give birth again, then you stop.’

Male focus group respondent, Tetaku

‘It means your wife should have her children and stop.’

Male focus group respondent, Tetaku

Some focus group participants mentioned the use of contraception for birth spacing and even cited examples of women in the villages who were known to have used family planning for this reason. Male focus group participants who said they knew women who were users but

they could not reveal their identities and the matter seemed to cause great hilarity. When people speak of using family planning, they mean female methods; contraception for men is usually totally unacceptable and is not taken seriously in conversations (personal communications, interviews and focus group discussions 1995-7). Questions and discussions on the use of family planning, and particularly the use of condoms, were invariably greeted with laughter. Generally there is still great ambivalence towards its use (Antwi-Nsiah et al 1995; Adongo et al 1998), particularly among men. A Navrongo research discussant remarks:

'If they know you are doing family planning they laugh at you'

Male discussant quoted in Antwi-Nsiah et al 1995:7

Interestingly, several participants, male and female, in my focus groups thought family planning use could be justified when hunger made it necessary:

'when you've born plenty and can't get food you can use it.'

Female focus group respondent, Gore

'It's for use when there is shortage of food and you don't get money.'

Male focus group respondent, Gore

Among the 40 or so male and female villagers interviewed in the 5 focus group discussions, virtually none admitted to using family planning, though the respondents in one female group had been previously identified by their peers as contraceptors. There was animated discussion, obviously involving some anger and some fear and embarrassment, on the part of the individuals who it was claimed were using family planning.

Of the few who do use family planning, health staff and community members say injections and pills are the most popular, though there are problems with both of these as the TBA and village health worker who translated the male focus groups expounds:

'Most use the tablets [contraceptive pill] and they don't take them correctly. Many haven't informed their husbands so they hide the tablets. When they go to a funeral, they won't want the people there to know they are taking them so they leave them behind. When you stop like that at a funeral and you go [with a man] it's easy to become pregnant.'

TBA and VHW, Gore

'Many like the "tt" [depo-provera, injection] but many say if you take it plenty you won't born again...My wife was taking it but her blood wouldn't be coming plenty - only small, so she couldn't take it again...many women have like that. They talk to their friends and they wouldn't take.'

TBA and village health worker, Gore.

The Navrongo research centre have highlighted the social structures which perpetuate male dominance in gender relations. A recent paper describes how in Kassena Nankana district men may see family planning as undermining their dominance and sexual ownership of a woman and 'family planning thus threatens husbands with derision and ostracism among male peers' (Adongo et al 1998:1795).

There is little discussion of family planning between spouses - largely because fertility decisions are considered to be the prerogative of the man (Fayorsey et al 1994:25; Kannae and Pendleton 1998). Many studies indicate low family planning use if male knowledge and support of the topic is limited (for example, Makomua 1991 in Zimbabwe; Ezeh 1992 and Kannae and Pendleton 1998 in Ghana; Renne 1993 in Nigeria).

Condoms are especially problematic in these communities because their use carries connotations of promiscuity:

'The women think [condoms are] a dirty job...they think it's for boyfriends and unmarried women, to stop them [getting pregnant]. Once they are married they don't see the need for it...'

Garu CHN-FP

'Men don't come much...they see FP as an access to flirting...'

StfEN, OPD, Bolga hospital

For women, the fear of physical reprisals prevents most from even discussing the use of family planning. One paper found that nearly 72% of married women in Kassena Nankana district had not discussed family planning with their husbands in the last year (Debpuur et al 1994 cited in Adongo et al 1998) and that is in a district whose population has had considerably more exposure to family planning discussions than the population of Bawku-West.

When staff at facilities in the Upper East were asked how they thought attitudes and behaviours could be changed with regard to condom use, most replied that men should be involved with talking to men. Female nurses agreed that male villagers did not take them seriously because they were women. Many suggested that the Ministry of Agriculture extension officers could play a role in condom advocacy because they were already accepted in the communities, and respected for their efforts to address community priorities (food and water) and were therefore more likely to be listened to. The Ministry of Agriculture did undertake condom distribution for a while, but it stopped through lack of follow-up and regional support.

5.2.3 Traditional versus Western medical belief systems

Finally a comment is in order on the differences in perception of western and traditional healing systems, the impact of this for clinic utilisation and the generational timeframe needed to bring about any change in perception. The preceding chapter showed how low utilisation of bio-medical health services and their frequent use as a last resort, was partly the result of the lack of community education, lack of sensitivity of poorly paid staff and their perceived inefficiency, large distances to be travelled, high costs and frequent shortages of medications. In an interesting analysis of cultural beliefs about illness management in the Northern Region, Kirby maintains that while such factors undoubtedly contribute to low utilisation, '[m]ore constraining than all of these are the conflicting cultures of illness management' (Kirby 1997:215).

Belief in witchcraft or spirits as a cause of some diseases, notably AIDS, is still widespread. In traditional belief systems, illness can be physical or spiritual (supernatural) in origin and therefore requires at least a combination of approaches⁷¹. Traditional healing systems give a whole social meaning and explanation of sickness and health, never treating a symptom in isolation, and treating each person as an individual and as a whole (Twumasi 1979; personal communications and observation 1996-7; Kirby 1997). Western medicine in the other hand addresses the manifestations of sickness and rarely the meanings of health and illness. In the case of AIDS, acknowledgement of the western explanation of the disease leads to

⁷¹ See Twumasi (1979), Kirby (1997), Senah (1997) and Tsey (1997) for detailed and informative discussions on Ghanaian traditional perceptions of illness and health systems, the extent of their acceptance of modern medical systems and the impact of Western disease concepts and services on indigenous thought systems.

stigmatisation of the infected individual. By explaining the disease in traditional concepts, through witchcraft or sorcery, stigmatisation is minimised.

Overlaps in these two systems of interpretation can lead to misunderstanding, fear and suspicion, which affects the perception and use of health services. There were, for example, rumours among village communities in the Upper East that the blood samples which nurses were collecting for sentinel surveillance of HIV in ante-natal women, were being used for *juju* (black magic) and the nurses themselves were even regarded as witches (personal communications 1996-7; Interviews, health staff 1996). The medical reasons for collecting the blood samples were not explained to the clients, so they were interpreted according to traditional practices and beliefs. Interestingly, nursing staff recognise the importance of communication to reassure clients about medical procedures. Chapter three noted that MCH staff felt it was important to explain to clients that any routine screening for STDs was entirely 'normal' procedure, done for everyone.

Fundamental changes in belief systems take generations. A Sudan Interior Mission⁷² worker described the reaction of a Chief to a childhood measles vaccination programme they had been running in his district for more than decade:

'He came up to me one day and said "you know, we've been noticing that fewer children are dying of measles these last years, and we wanted to know, is it because of your medicine, or is it because the ancestors are pleased?"'
SIM worker, 1996

Even in Kassena-Nankana where rural communities have had considerable exposure to health personnel over the last decade through the research in Navrongo, the communities are changing very slowly and health personnel are only beginning to be seen as legitimate healers (Antwi-Nsiah et al 1995).

Given this long-term time-frame, the need for western and traditional healers to work more closely together has long been expounded but to date little has been done (Twumasi 1979; Tsey 1997). It is certainly necessary if misunderstandings about some medical practices are to be countered and if appropriate health education messages are to be developed to address

⁷² A Christian based, US funded non-government health organisation which spread out from its initial work in the Sudan and now supports a number of health programmes in the Upper East.

sexual and health seeking behaviours. Without this, self-referrals to clinics and hospitals will remain a last resort for many Ghanaians.

5.3 SUMMARY

This chapter has illustrated a variety of community level factors influencing disease perceptions and service utilisation which range from practical, physical experiences of life related to poverty, to social concepts of status, gender hierarchies and notions of respectability and womanhood. The latter group in particular tend to mitigate against utilisation of STD/HIV and family planning services, especially by women. A number of pertinent points can be summarised:

- Health services are perceived as expensive (transport and services) and poor quality.
- Disease priorities do not lie with STD/HIV but with wider health priorities relating to food and water.
- Medical practitioners and community members hold different perceptions of the causes and treatments of AIDs and STDs.
- Victim blaming of STDs (especially of women) is widespread.
- Female identity and respect is gained through childbirth.
- Family planning, STD/HIV and sexuality are taboo topics.
- Condoms are culturally unacceptable and all family planning is highly stigmatised.
- A number of high risk behaviours are common viz. male sexual networking and dry sex.

Chapters three, four and five have illustrated a range of contextual factors highlighting how profoundly they can influence service provision and utilisation, particularly the often neglected social-behaviour factors. The analysis has indicated the importance of regarding all these factors as a continuum, since the different factor-types are interrelated and often difficult to extrapolate.

There are two key questions as we turn to the higher levels of the policy process. One is whether and to what extent policy decision makers are aware and take account of these contextual factors when they develop policies. The other is what and how do contextual

factors influence the policy process in the higher echelons of policy making, and what are the implications for policy.

CHAPTER SIX

REGIONAL ADMINISTRATIONS - AMBIGUITIES AND UNCERTAINTIES

The regional administrations represent a crucial link in the communication chain between local and national levels and have a number of critical functions in addressing the implementation issues faced by the districts and sub-districts and forwarding information on these to the national policy makers. Currently the regions appear to be being marginalised in the policy process with the decentralisation of the health sector giving more autonomy and financial control directly to the districts. Following the creation of the Ghana Health Service (GHS) as an executive body, the regional offices are now envisaged as outposts of the national executive, rather than as intermediary line managers as was formerly the case (Brugha and Taylor 1998). The former Director of Medical Services acknowledges that recent changes 'have left the regions in a grey area' (Interview Otoo 1997).

A brief introductory section details the decentralisation process which provides the context for the current roles and uncertainties facing the regions. The following section describes the organisation of the region, the regional actors, their networking patterns and the potentials and implications of these for integrated service implementation. After this, the role the region does and could have in the addressing the areas of difficulty in policy implementation identified in the previous chapters, is discussed. The material here is organised according to the main functions of the region: funding; supply flows; data management and surveillance; training and health education. Through the discussion the influences of concepts of status, hierarchy and power on the decisions and actions of actors are highlighted leading to an assessment of how effective the regions have been, and could be, in providing the mid-link in the policy communication chain.

6.1 THE DECENTRALISATION CONTEXT

As part of the IMF structural adjustment conditions, the Ghana Government committed itself to a policy of decentralisation of public administration in the 1992 constitution. The new institutional structures and the roles and functions of the various national, regional and district agencies are spelled out in a number of legal instruments⁷³ that have promulgated

⁷³ These include:

- Local institutions to gain decision making autonomy 1992 (PNDC Law 207)
- The Civil Service Law 1993 (PNDC Law 327)

into law during the past few years. The process of decentralisation in Ghana is ongoing. The Ministry of Health is seen as having taken the lead in the process, but it is constrained by the slower response of the Ministry of Local Government without the decentralisation of which the MoH cannot operate in a decentralised manner at the district level. Ambiguities are fuelled by the sometimes contradictory legislation on health and local government structures (Cassels and Janovsky 1996). There are unresolved issues around the roles of local government and health in administrative and financial controls and in how they will link with each other and with other government sectors. Local institutions and district administrators were pledged political independence and increasing autonomy of decision making (PNDC Law 207, 1992) with national - local communications mediated by regional personnel. To achieve this, the MoH established District Health Management Teams (DHMTs) in each of the 110 districts. Regional administrations are also in place although their roles and functions have not been clarified or consolidated and current policy focus tends to bypass them in favour of directly strengthening the districts. The ambiguity of the regional role prevailed during the period of research and many questions remained unclear.

Contemporary commentators are divided in their interpretations of the 'success' of decentralisation. Researchers and some ministerial personnel regard the districts as still very dependent on central government funds with financial and administrative decentralisation slow to be realised, leading to dual systems of economic and political structures which reinforce existing power-relations and create new types of 'big men' (Codjoe 1994; Crook 1994; Massing 1994; Ayee 1996; Cassels and Janovsky 1996). Other ministerial personnel see the process as having begun well and its full implementation therefore a certainty (Interviews, national and regional administrative health personnel). In abeyance with national rhetoric on the centralising and streamlining of donor and NGO activities and inputs, decentralisation has favoured the preferences of many who go directly to districts only paying courtesy calls to the regional offices. In April 1997 a move was announced on national television to establish greater links between NGOs and district assemblies which was to involve NGO representatives, MPs and district chief executives - regional personnel were not mentioned.

Donors and NGOs are actively in favour of the decentralisation process and a directive sent from MoH HQs to all Regional Health Management Teams in April 1997, implies certain

-
- Local Government Act 1993 (Act 462)
 - National Development Planning Commission Act 1994 (Act 479)
 - National Development Planning (System) Act 1994 (Act 480)
 - Local Government (Urban, Zonal and Town Councils and Unit Committees Establishment) Instrument 1994 (L-I 1589)

pressures at the national level: it states that 'Headquarters is under severe pressure to issue direct FEs [Financial Encumbrances] to districts' (Internal document, 1997). The impact of decentralisation of the health sector is undoubtedly having an impact on the financial autonomy of the regions with their traditional roles in assessing and controlling district finances being diminished as funds go direct to district administrations. The close association of money and financial control with power and status (see section 6.3 and chapter 8, section 8.2.2) means that the current ambiguity has a particularly profound effect on the identity of the regional health administration.

6.2 REGIONAL HEALTH ACTORS: ORGANISATION, LINKS AND NETWORKS

There are ten regions in Ghana, the newest created in 1983. In theory regions should have a role in supervision of districts, quality control, training and capacity building but there is no available documentation on this. Many uncertainties remain and there is a tension between their administrative and technical functions (Brugha and Taylor 1998). Local government structures at the regional level, namely the 'regional co-ordinating council', serves largely to co-ordinate activities, keep records and generate data. The health administration of the Upper East has about a dozen key staff filling posts which exist at all regional health administrations. In 1997 it received a budget of just under 0.3 million cedis with a further one million going direct to district and sub-district management teams. The organogram in Figure 6.1 indicates the main actors involved in health in the Upper East in both the MoH and local government.

6.2.1 Linkage and networking opportunities

The cast of significant actors in the Upper East is small and regional personnel generally have widespread knowledge of district activities. Official regional co-ordination mechanisms, however, can be poor and active links occur more at the district than the regional level. Feedback comes to the region via the district medical officers who make regular visits to the regional health management team.

Figure 6.1 Organogram of Actors Involved in Health in the Upper East Region

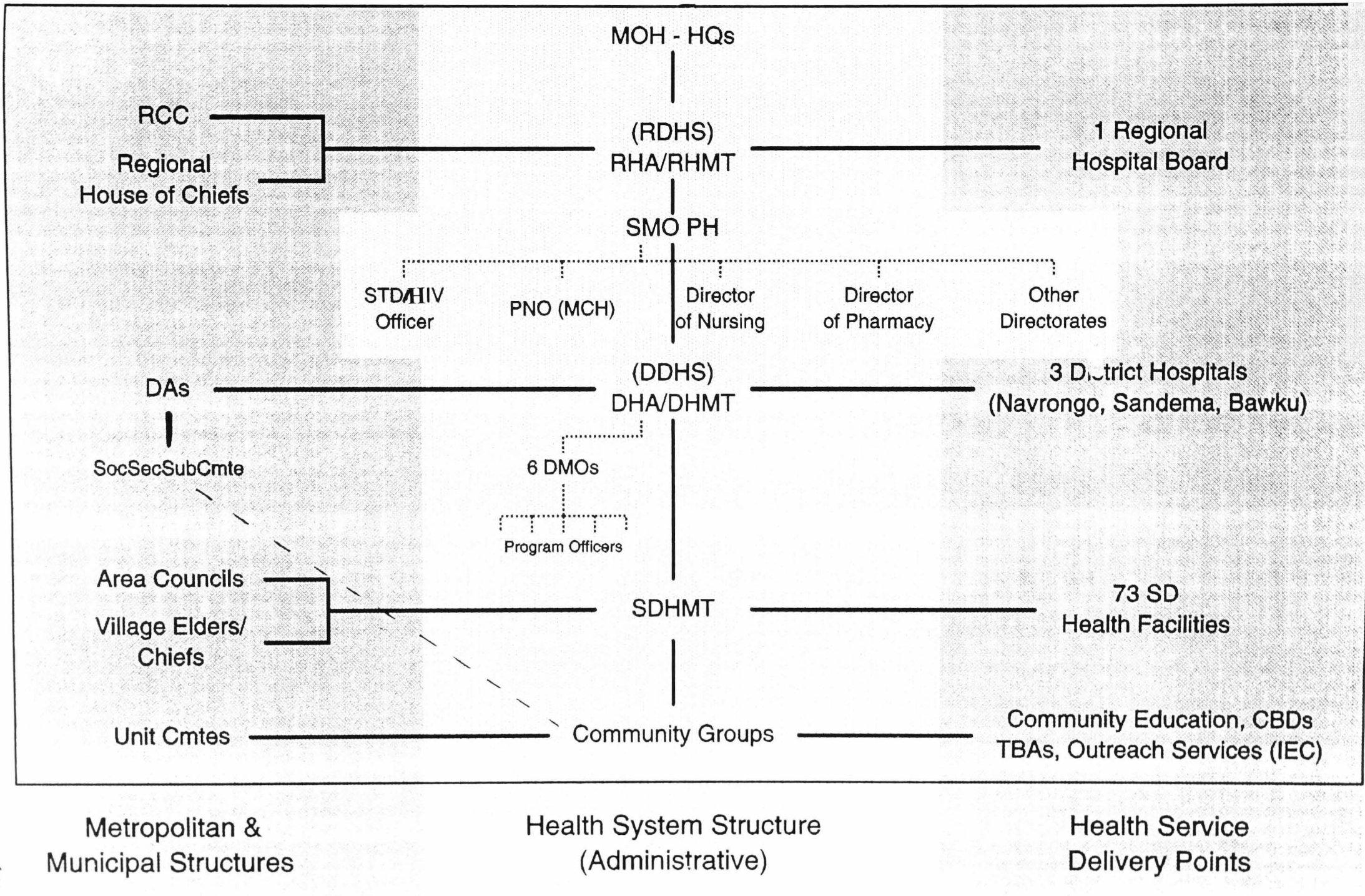

Mayhew 1997

Regional personnel feel that there are more opportunities to link with district health teams now and there are freer communication flows as decentralisation is beginning to have an effect and districts have the confidence to assert themselves. This can result in regional frustration at the perceived arrogance of district medical officers who like to do things their own way and may be reluctant to share district initiatives with regional co-ordinators (Interview, Bodzie, 1996). Personal observation and contact made it clear that the depth and effectiveness of district-regional relations are largely determined by the personalities of the district and regional medical officers.

Within the regional health administration information sharing on activities and funds available seems good. Although most funds are not actually flexible, transport costs and manpower resources may be shared. Since vehicle and fuel capacities are limited, several members of the RHMT will go together on the district or sub-district outreach visits for various missions including information collecting and supervision. The efficacy of supervision in the districts was not evident, however, and from personal observations social contact seemed to be as important as professional support.

There is a certain amount of integration at this level between officers representing different national units. All RHMT members, including programme heads, meet weekly to decide venues for the week including supervision visits to the districts; there is also a weekly outreach supervision. Regular contact with regional personnel during the fieldwork period suggested that these did occur. The monthly regional health management team (RHMT) meetings are also venues for discussing training, other activity programmes and sharing information about funds which may have come in for these.

Links with other sector ministries, national NGOs and local groups occur mostly at the district level. There are numerous collaborations between NGOs like Ghana Red Cross and local church-based enterprises in the districts as the preceding two chapters showed. The Catholics and the Anglicans are particularly active, supporting village health initiatives, community clinics and food relief to villages hit by hunger in the lean season.

Regional co-ordination mechanisms between the Ministry of Health and NGOs and across sector ministries are poor. A number of regional level structures are supposed to have a co-ordinating role to ensure that NGO and sector ministry inputs do not duplicate or overlap, but complement each other. The Ministry of Health is supposed to forward information to the Regional Co-ordinating Council and to the National Council on Women and Development

(NCWD) which is supposed to co-ordinate district programmes concerned with women, largely relating to income generation (Interview, Regional NCWD Director, 1995). In practice, links between health and these municipal structures at the regional level seldom extend beyond courtesy statements of intended action (personal observation; Interview. Awuni 1995; various interviews 1996-7). Ineffective regional co-ordination leads to situations where several missions are operating in the same village without realising and pooling skills and resources (personal observation and interviews with members of local NGOs, church organisations and communities 1995-7).

Given the extent of poverty in the Upper East Region, activities of churches and NGOs do complement government health care initiatives simply because the need is so great, though greater equity could be achieved through better co-ordination. At the regional level, many NGO and church groups find the bureaucracy frustrating and regional assertion of autonomy over incoming resources and funds can lead to conflict (Interviews and personal observations, 1995-7). Where possible, they tend to focus on the district level, where relations between the MoH and NGOs/churches are often good.

6.3 FUNDING MECHANISMS - 'NO MONEY, NO FRIEND'

The facility level analysis indicated huge resourcing and funding needs at clinics throughout the region. Activity-specific funds which currently come in, for example for training or immunisation activities, can be highly disruptive of routine service delivery. The reasons have to do with the nature and control of funding which are perhaps the most crucial elements of development aid. Vertical funding systems are still much in evidence and flexibility to allow local priority-setting and decisions is limited, yet disease-specific programmes like STD/HIV rely on this type of funding to secure support. This section highlights the difficulties relating to source, timeliness and flexibility of in-coming funding and the implications of these for integrated STD management.

The funding issue takes on additional importance at the regional level because of its associations with social status and power. These concepts have been the subject of detailed scholarship by Ghana researchers (see for example, McCaskie 1983; Wilks 1993; Nugent 1995; Gyekye 1996). Gyekye notes that 'an intense desire for material wealth and success was an integral part of the religiosity of the African' (Gyekye 1996:101) and a great number of Akan proverbs attest to this association of wealth and social status which construe importance beyond good family connections:

Money is king

Fame of being nobly born does not spread, it is the fame of riches which spreads

One does not cook one's nobility and eat it, it is wealth that counts

These ideas make the control of finances and financial decision-making a potentially contentious issue. The increase of funding and decision making powers for the districts, with the introduction of decentralisation, is one of the major reasons for regional personnel feeling threatened and marginalised (Interviews, regional health management team 1996-7; personal observations and personal communications 1996-7).

6.3.1 Funding sources, controls and regional revenue capacities

Regional finances and controls are caught between two levels: they receive from and are responsible to national HQs and donor offices, but are required to pass funds on to the districts which also may legally raise income.

The future nature of regional funding is unclear at the present time since there is discrepancy at the national level over who will control health budgets under the decentralised system: the Ministry of Health or the Ministry of Local Government⁷⁴. This will have implications for the amount and timeliness of funding available for health services and particularly for locally prioritised diseases.

The flowchart below illustrates the basic flows of finances in the health sector in Ghana. The broken lines represent lines of donor funding which are being superseded by the 'common pot' ethos, although they still occur, often in the form of specific 'one-off' activities (like training sessions) or through NGOs.

⁷⁴ Under the 1993 Local Government Act, Health is one of the Ministries for whom funding will be decentralised, meaning Health will compete with other sectors for funds at the district level. However, under the 1997 Ghana Health Service Act, the Ministry of Health retains financial autonomy and Health officials believe this situation will prevail (Interview, Smithson 1997).

Figure 6.2: Flowchart of funding mechanisms

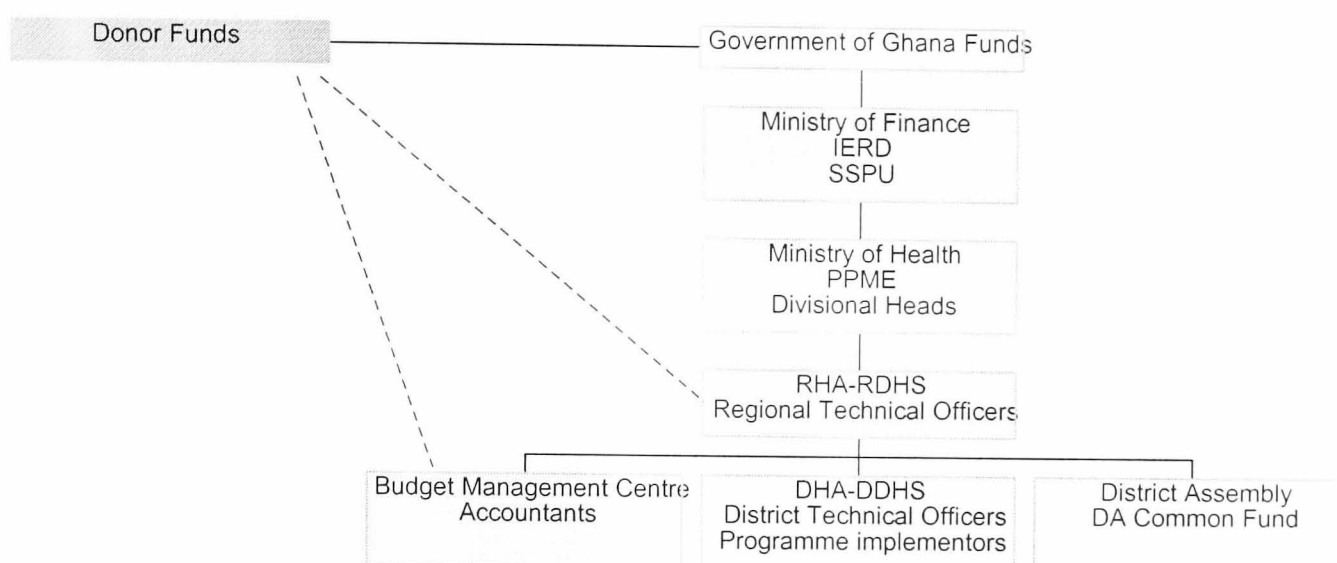

The consolidated fund from the MoH is the main tangible source of funding to the region and districts. This represents a complex balancing of tensions on the part of the region between vertical programme initiatives and integrated health services support. The regions are responsible for drawing up regional budgets under the item headings which money is received under (manpower, drugs, maintenance and so on) but these have to be based on district spending estimates which are allocated according to programme components (antenatal care, family planning, immunisation and so on) (Observation and RHMT Interviews 1996-7).

Once approved, these budgets are disbursed to the different budget management centres⁷⁵ at the region and in the districts. District and sub-district budgets (one million cedis in 1997) are already allocated and are passed on directly; the regional hospital is funded directly from central MoH funds. From the consolidated budgets, the regional health management team gets funds for recurrent expenditure and for programme specific activities which generally require vertical reporting procedures. Funds earmarked for the latter are passed on to the regional Technical Officers to feed to their District counterparts for implementation.

⁷⁵ Under decentralisation of funding, district and regional health management teams, regional and district hospitals were each designated Budget Management Centres, receiving and responsible for government health sector allocations.

The tendency to allocate funds for vertical programmes is enhanced by incoming donor funds which are still identifiable at regional level although physical donor presence is not. The Upper East region receives only small amounts of defined donor funds (less than 0.1 million cedis of a total budget of 2.2 million cedis in 1995); unlike some other regions, no donor has 'adopted' the Upper East⁷⁶. The donor funds are usually activity-specific⁷⁷ and require vertical returns⁷⁸. The major donors in the Upper East are USAID, UNFPA, WHO and UNICEF. Donor monies and support may come into the region in kind (as contraceptives, test-kits, vehicles and so on) and donors are increasingly contributing to the MoH recurrent budget, which makes it difficult to differentiate between incomes from MoH and donors. The scale of donor involvement is indicated by a cursory glance at the MoH vehicles: the majority bear the slogan of an international donor.

Aside from government consolidated funds and donor funds, there are few other sources available to the regions, which do not have independent tax raising powers. Districts, however, do have a number of other sources available independently of the regions. Internally generated funds are one source, though these are not very significant in a poor region like the Upper East. They come from a revolving drugs fund and fees charged for consultation, theatre and equipment. The scale of fees and what items should be charged for is currently undergoing review after internal research suggested widespread abuse of the system in terms of illegal fees (Dovelo et al 1992; newspaper headlines 1997). The District Assembly (DA) common fund⁷⁹ also represents a potential source of funding for health. District health management teams must apply for this is on a competitive basis with other sector ministries and success in allocation depends on priority-setting and individual lobbying ability:

This common fund is meant for priority projects in the district. So as it happens, that a health project is seen to be a priority project within the DA's

⁷⁶ A number of donors concentrate their support in particular regions where they channel health and other sector funds. DANIDA has taken over the Upper West; DFID supports Volta and Brong Ahafo regions.

⁷⁷ Despite the 'common pot' initiative which eliminates donor earmarking of funds, this style of funding is set to continue for two of the largest health sector donors, UNFPA and USAID, at least for the duration of their current five-year programmes due to end around the year 2000.

⁷⁸ These are often from PPME, the MoH budget section. Returns for UNFPA programme funds however, go direct to UNFPA's own special accountant-manager within the MCH unit at MoH HQs (Interview, Brobbey 1996).

⁷⁹ Under the decentralisation of local government, district assemblies are to receive a 'common fund' from central government to use for locally defined priorities, meeting certain criteria. In addition to this, the districts have the power, to levy fees and local taxes, for example on market stalls and sellers, property ownership and the registration and operation of druggists and private clinics (Local Government Act 462; PNDCL 207; Bawku West and Bolgatanga District assembly Fee Fixing Resolutions, 1997).

overall plan, then they will finance it from this common fund... so if the district director of health services is able to make his case very clear, and win the confidence of the DA members then automatically they will assist him with whatever plans that he has there.'

Regional Administrator, 1997

The common fund could become increasingly important as decentralisation is established, though it is as yet underestimated and under-utilised by the MoH (Interview, Antwi 1997).

6.3.2 Timeliness of funding

Disbursement of funds to the Regional Health Management Teams (RHTMs) is often delayed by the process of approval of budget estimates (Interviews, Brobbey, Amankua, Quaye 1996-7). The Upper East regional health management team did not receive its approved 1997 budget estimates until June 1997. Such delays adversely affect policy implementation because for the first quarter of the year, health management teams are operating within provisional budgets and are naturally cautious on spending (Interview, Brobbey 1996 and 1997).

MoH and donor funds which are marked at the national level for specific activities frequently fail to take into account day to day schedules of regional and district staff. In particular donor funding 'comes in bits to various programmes throughout the year' making it very difficult to implement ongoing integrated programmes (Interview, Angyogdem 1996). The ramifications for implementation in the face of such cash flow difficulties are recognised even at the national level as the External Aid Co-ordinator describes:

'every group wants to have their own constituency, and in doing that you have HIV/AIDS people who have drawn up the plan of action, who have funds from different donors for particular activities which they don't implement, but which people lower down there implement, and the same for MCH/FP and what happens then is that from no-where they get a cheque for C2 million - "could you please do training on counselling and so on and we will send you a resource person". And the next week they get another amount of money - can you do TBA refresher training, or can you do

something on baby-friendly hospitals or breastfeeding. Very disruptive for them...'

External Aid Co-ordinator, MoH HQs, 1997

6.3.3 Flexibility of finances and priority funding

Handling of finances may be decentralising, but decisions on spending are not, and funding flexibility is still centrally controlled. Neither the in-coming funds within MoH budget items, nor the earmarked funds from donors for specific programme activities like training or mobilisation for vertical activities like National Immunisation Day (UNICEF funded Polio vaccinations for children) leave much room for manoeuvre. Such monies are 'normally addressed to the regional director of health services, and the accompanying letter will specify what the money should be used for and how returns will be submitted to head-quarters' (Interview, Brobbey 1996).

Within the consolidated funds, national directives specify that funds cannot be moved across budget items, though virement may be made within the item (1997 Approved Estimates, MoH Guide for Operation, internal document, 1997).

NGOs who are trying to collaborate with the MoH and local officials, feel that flexibility at the District is still very limited because of the cumulative controls imposed by both the national level and the regions who guard what authority they still have:

'There needs to be some autonomy at the district level...they're not decentralising at all. The strings are still very tightly held at the regional level.'

Action Aid Programme Manager, Bawku, 1997

'...by the time money passes through the MoH, from the region, through the regional director, the district director, by the time it gets to the village, we know how it is all to be spent.'

Assembly man and member of Sub-District Health Committee,

Binaba sub-district, 1997

Nevertheless, it appears that districts have more flexibility with funds than the regions who simply act as administrative intermediaries. For example, although donor funds also come

'more or less with strings' for particular programme activities at district level, district officers maintain some leeway, and managers talk of 'ways and means' by which they can shift programme funds at the implementation level, 'providing the main thrust of the project is achieved' (Interview, Anyogdem 1996; Interview, Brobbey 1997; Interview Quaye 1997).

National level funding for disease specific programmes often relies on particular diseases being classified as a priority, or on funding being flexible enough to re-direct it if local priorities do not co-incide with national ones. Although STDs are seen and are being treated in the districts, at the region the overseeing and co-ordination functions for the STD/HIV programme are barely evident despite lip-service to it as a national priority. Preceding chapters have shown that in the Upper East STDs are not a priority disease, neither does national funding come into the region for STD activities. Programme activities that do take place at this level are practically all vertically funded by donors, usually through the National AIDS Control Programme. In recent years that money has declined, more of it going through central pots, and STD and HIV programmes rarely benefit; in this respect the 'donor basket' (see chapters 7 and 8) and the non-earmarking of funds would appear to be detrimental:

'[money] used to come purely from donors and NGOs but the whole of this year we've received nothing... There is no money to AIDS or even disease control; it comes to the directorate, and for running costs, vehicles, and maybe for health education...So far as I'm concerned no money comes to me for STD/HIV.'

Regional STD/AIDS Co-ordinator, 1996

There may be other avenues for financing of STD programmes, but harnessing them requires positive advocacy and imaginative employment of existing resources rather than a passive reliance on vertical donor funds for specific activities which is the current tendency.

6.4 SUPPLY FLOWS: CONTRACEPTIVES, DRUGS AND REAGENTS

The region has a responsibility to procure and monitor drugs and contraceptives from the national level to stock at the regional medical stores from which districts collect what supplies they need on a regular basis. Facility level contraceptive supplies are good; drugs are more problematic. Again donor inputs play a major role and the difficulties of third cycle drug procurements and testkit shortages stem from cost issues and low donor involvement in drug supplies compared to contraceptive supplies. This section considers the donors' role in

supply flows, then looks briefly at related issues of drug storage and transportation and pharmacy capacities.

6.4.1 Supply factors: donor inputs

The chart below shows the flow of drugs and contraceptives through the levels; disbursement is made on a remuneration basis.

Figure 6.3: Drug and contraceptive flows

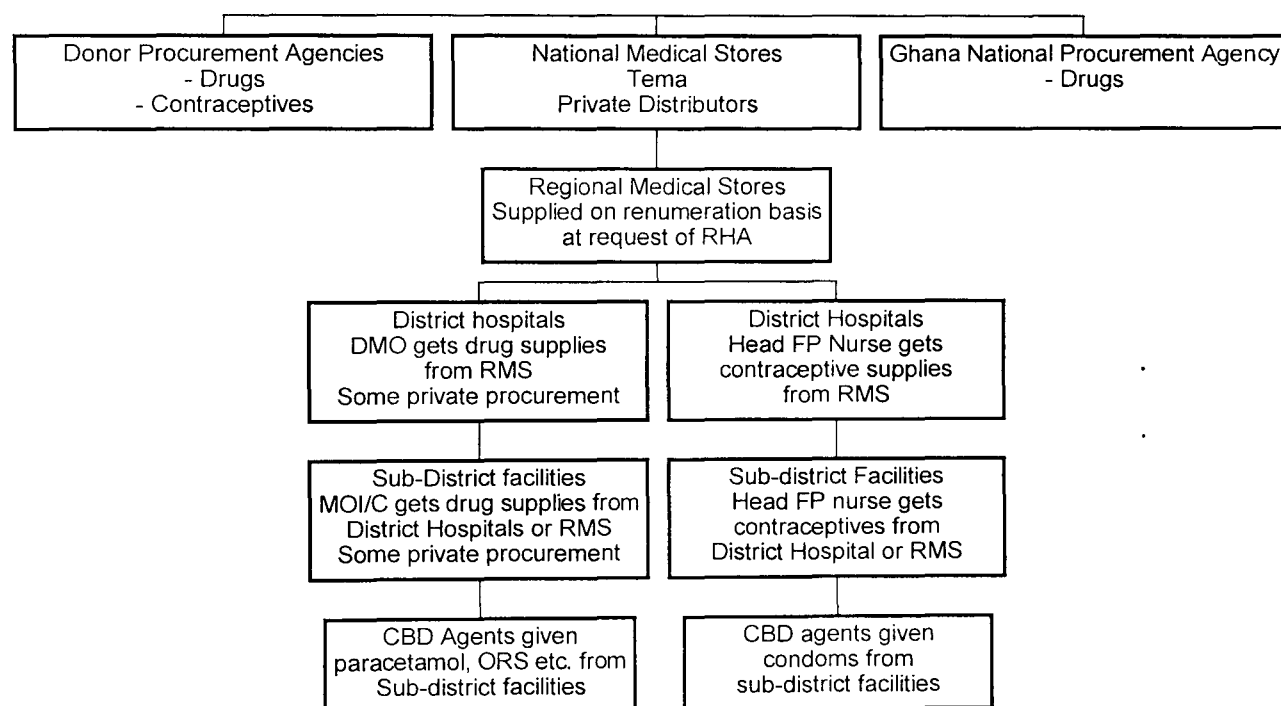

The contraceptive delivery system is entirely separate from drug delivery. Reliability of contraceptive availability is linked to donor supplies. In the Upper East there is not generally a problem with contraceptive supplies though there are sometimes shortages and ‘fluctuation’ of supplies, most recently with depo-provera, the most popular contraceptive method (Regional and district Staff interviews 1996-7; Draft regional annual report 1996). Contraceptives come from USAID and UNFPA⁸⁰ and are delivered quarterly from the Central Medical Stores at Tema in Greater Accra. They have their own vertical delivery and accountability structures, with family planning unit heads in each region and at each facility being responsible for procuring contraceptives and collecting monies for them, separate from other medical supplies and drugs. Reagents for STD and HIV tests also come through Tema Central Medical Stores, and again are from the donors: the HIV reagents are from USAID

⁸⁰ Other donors support USAID and UNFPA contraceptive procurement initiatives but do not directly procure - so for example, DFID funds UNFPA’s contraceptive procurement strategy.

and the Gonorrhoea ones were funded by CIDA/EU until recently, both as part of a national surveillance programme. No other donors are directly involved in STD/HIV reagent procurement.

The main problem in the Upper East is in the procuring of second and third cycle STD drugs including erythromycin, doxycycline and clotrimazole and, especially, those effective for Gonorrhoea (ciprofloxacin and ceftriaxone). According to the regional director of pharmaceutical services, the main reason for their unavailability at regional level is because they are considered too expensive (both for RHMT to buy for the stores and for the clients to buy to use) although there have also been problems with the cheaper drug, 'nystatin'. He said there are 'line problems' with Ciprofloxacin and Doxycycline meaning they are difficult to get from Accra (probably again for reasons of cost). That the regions do have a certain amount of autonomy in some matters is shown in a decision taken by the regional Pharmacists with the regional doctors, not to stock erythromycin at the regional stores because it 'is not tolerated' by many patients (Interview, regional pharmacist, 1996) although this is one of the WHO/GoG recommended treatments for a variety of STD syndromes (see Appendix 10). Second line drugs are sometimes available at private pharmacies and drug stores (see chapter 3 section 3.3.2).

The Bawku-West District Medical Officer suggests that shortages and delays in drug supplies may be 'the result of the district locking up its revolving funds by buying drugs which aren't used...without careful thought about disease priorities...The cash and carry system means we buy as and when' (Interview, Quaye 1997). He believes that 'meticulous planning should avoid this'. Most often though, the reason for erratic procurement remains one of cost; and the cost of drugs, in particular the newer and more effective STD drugs, is a major constraining factor cited at all levels (see chapters 3 and 4).

'the major problem is the availability of cash... at first, we were sold drugs on credit... but the patients couldn't pay, so now we have to pay before we get the drugs.'

Bolga HC, Dispensing Technician

There is currently no national procurement strategy which could help to decrease the cost of drugs, although this has been recommended by donors and NGOs (USAID 1994; Interview, JHPIEGO 1997) and donor involvement in drugs procurement is limited.

6.4.2 Drug storage and transportation

Clinic data suggests that for many rural facilities storage conditions are inadequate, resulting in drugs spoiling or going out of date (Interviews and observation 1996-7). Regions are supposed to monitor and check storage conditions and expiry dates for contraceptives and drugs, but the regional director was non-committal and defensive on this. He admitted that they are 'not checked at lower levels' (Interview, Regional Director Pharmacy, 1997).

Collection of supplies relies on transport which isn't always available and some roads in the Upper East may be impassable during the rains. Medical officers have to come themselves to regional medical stores and collect their drug supplies when they need them. This depends on them having a road-worthy vehicle, time and money. If the drugs are not at the stores, a return trip is necessary. From the furthest districts a whole day is needed for one trip, taking the most senior personnel away from service delivery duties. District level transport is severely limited and often personal vehicles (belonging to the District Medical Officer, the church or NGO personnel) are used.

'Our problem is the drug supply and the transport - we don't have our own means. At times I want to go to the regional stores, just to see if they have the drugs, and it's far. I'm lucky, I have my own motor.'
Bolga HC, Dispensing Technician

Similar transport problems apply for regional personnel who have to travel 400 miles to Tema to collect their supplies.

6.4.3 Pharmacy capacities

Health facilities often advise clients to buy certain drugs outside, from a drugs store (see chapter 3 for the availability of drugs at drug stores in Bolga). According to the Regional Director of Pharmaceutical services, there is only one officially qualified and licensed pharmacist in the Upper East which opened at the end of 1997. All other 'pharmacies' or 'drugs stores' are run by chemical sellers. Chemical sellers are legally registered with the Pharmacy Council of Ghana, represented by the Regional Director of Pharmaceutical Services.

There is some evidence of regional authority for taking regionally relevant decisions, in this case over who can supply drugs to the public. Chemical sellers are not legally supposed to supply antibiotics, but the Regional Pharmacist says ‘I make some concessions that perhaps I shouldn’t...because I think it would be doing a dis-service to the clients if we didn’t allow them [chemical sellers] to supply the drugs the Ministry can’t get.’ (Interview Regional Pharmacist, 1998). He said that it is doctors who are responsible for the policies which say chemical sellers cannot stock anti-biotics. He suggested that such policies are made to ‘favour themselves’ since ‘they may feel that they are losing money which would go through them’ if pharmacists are supplying drugs which the doctors can’t get in their facilities, so they wish to keep the practice illegal (Interview, Regional Pharmacist, 1998).

Interestingly, the decision to allow prescribing flexibility is not extended to clinic use of drugs where medical practice hierarchies are upheld by the region. Staff below the ‘medical assistant’ cadre, including outreach staff, are, according to the District Director of Pharmaceutical Services, not supposed to use STD drugs. Indeed he claimed ‘officially the medical assistants shouldn’t use these drugs, but we make exceptions and they do’ (Interview, Regional Pharmacist 1997). The flexibility allowed for pharmacies and drug sellers is perhaps possible by default because from the national level down they are separate from the medical institutional set-up⁸¹ which strongly asserts its independence and is less easily controlled.

The table below shows the numbers of registered Chemical sellers and pharmacists in the Upper East:

Table 6.1: Chemical sellers and pharmacists in Upper East Region 1997

District	# registered Chemical Sellers	# Licensed Pharmacists
Kassena Nankana	19	0
Bongo	9	0
Bolga (Regional Capital)	35	1 (opened December 1997)
Bawku East	32	0
Builsa	10	0
Bawku West	6	0

⁸¹ The Pharmacy profession has its own regulating body, the Pharmacy Council, and union, the Pharmacy Society. Leaders of these bodies feel they are marginalised and looked down on by the medical profession (Interviews, Pharmacy Council and Pharmacy Society, 1996).

Observation in the regional capital, Bolgatanga, showed that the main street pharmacists had a steady flow of clients, especially on market days and at lunch times when many were crowded. While information and advice may be given, the medical knowledge of chemical sellers is limited and drugs transactions frequently involved the selling of just one or two tablets at a time. Antibiotics are available routinely over-the-counter (personal observations and communications, 1995-7).

6.5 DATA MANAGEMENT, SURVEILLANCE CAPACITIES AND PRIORITY SETTING

Data management throughout the districts is poor (personal observations 1995-7). In addition there are scant surveillance capacities in the Upper East and STDs are inconsistently reported at the clinic level. This section explores the vertical reporting systems and suggests that poor data management contributes to deficits in epidemiological data and STD surveillance, which results in low prioritisation of STD/HIV programmes.

6.5.1 Reporting and data collection - vertical structures and management inefficiencies

The regional health administration collates data forwarded from the District Medical Officers (who compile sub-district statistics and submit monthly-quarterly-half-year-annual reports to regional officers) and draws up reports for submission to both donors and MoH HQs based on directives given by the funders. These reporting requirements are vertical in the sense that they require activity-specific reports which are separate from routine returns. The main lines of reporting and administration are shown below; they are essentially vertical. Lateral links do exist between sector ministries and municipal structures although their continuity and effectiveness is often dependent on personalities and local politics.

The system encounters difficulties at all levels. At the clinic level, there are no medical administrators and data generation relies on the efficiency of the medical officer in charge, who has to record information from client records and information sheets for different sections of the clinic to forward to the district medical officer. This is in addition to their medical practice and day-to-day administration of the facility, consequently data processing is often slow.

District medical officers are also slow to forward data. They are often absent from their posts, attending meetings, workshops and seminars at regional or national levels, so delays

are common. Frequent position shifts also exacerbate delays (Interviews regional health administration staff 1996-7; personal observations 1996-7).

Figure 6.4: Reporting and administration flows

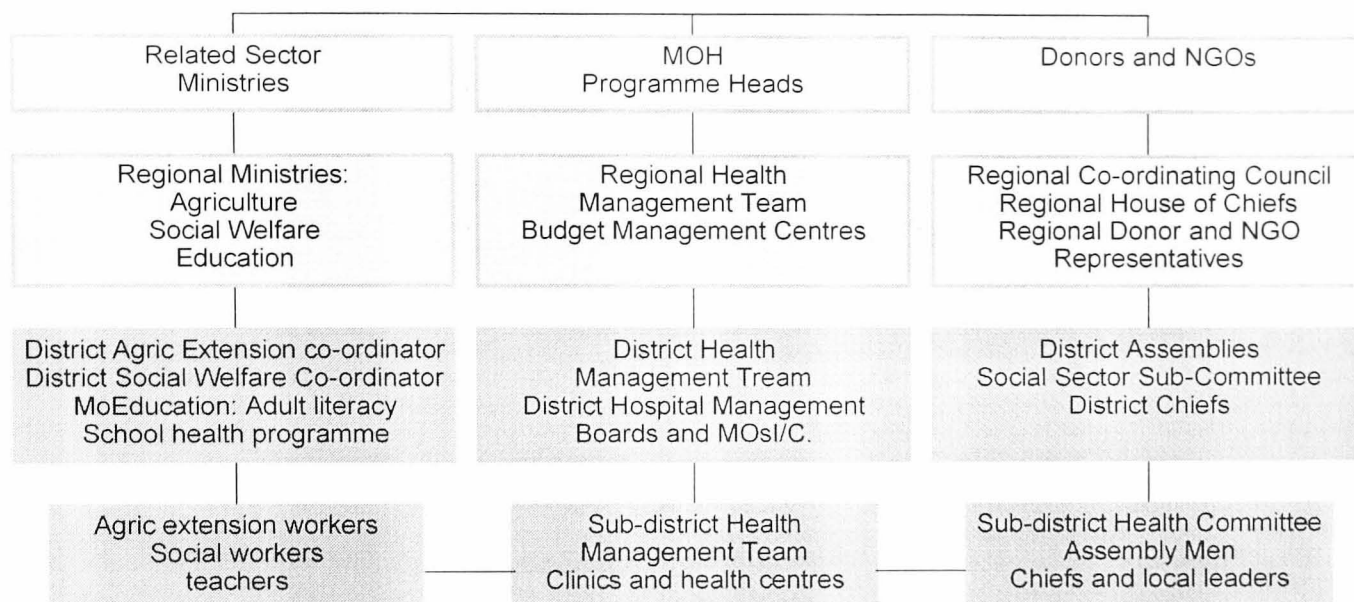

Once at the regional offices, data management improves, but there are discrepancies (for example in the number of health facilities and staff in the region) and processing is slow. The Upper East Region Health Management Team now has a computerised statistics room, but reliability problems exist lower down the scale with basic data collection and information flows which are not monitored by regional personnel (supervisory visits are to collect data rather than monitor how it is collated and recorded). As at February 1998, the 1996 Regional Annual Report was not complete. The draft statistics for communicable disease report sheets had not changed since July 1997 when they were incomplete. There are basic information discrepancies even between official sources. For example, annual reports and regional hospital reports do not agree on reported numbers of STD and HIV cases; three separate regional sources could not agree on the number of physical facilities in the region (GMOH(UER) 1996a, 1996b, 1996c). Figures on disease incidence are highly problematic, partly as a result of ambiguous recording procedures for STDs, discussed below and in Chapter three, and partly because good management and management information skills are limited at the facility level (personal observations 1996-7). Discrepancies in STD, HIV/AIDS statistics are shown in Figure 6.5 below.

The situation is not helped by the quantitative emphasis on data collection and the reporting of clinical activities to meet pre-ordained targets of coverage rather than ensuring reliability of data generation (Interviews, regional health administration staff, 1996). There is a dearth of data on quality care of medical practice and counselling and little urgency given to support

and feedback visits which were not undertaken at all in 1995 'due to time constraints' (GMOH(UER) 1996a).

6.5.2 STD surveillance capacities and data collection

Funding and priority for disease-specific programmes like STD management, relies on good data bases giving an accurate indication of disease prevalence and epidemiology. Surveillance capacities in the Upper East are limited and rely on donor support. Clinic level findings indicate that they are increasing in certain areas in the Upper East, particularly the boarder and mining areas and this is recognised by regional and district officers (Interviews, 1995-7).

There are four main laboratories in the Upper East: one at the regional hospital, two at district hospitals and one private lab in the regional capital (see Appendix 9). Three other facilities visited had small labs on site: a government health centre, a mission clinic and a private clinic. Of these all can offer basic vaginal and urethral swabs and grams stains, but only four (three in the regional capital and one in Bawku) can offer any more advanced STD or HIV tests and all complain of lack of reagents and high costs. Sentinel sero-surveillance surveys for HIV are done each year in the Upper East at the regional hospital on mothers attending for ante-natal care at the regional hospital. These are possible 'because the items [test kits] are procured at the national level and sent to us' (Interview, Angyogdem 1996). This is a short term programme funded by GTZ in 1996, in 1997 they were from USAID via MoH HQs who supplied materials and personnel. The regional co-ordinator says 'surveillance of other STDs isn't much' (Interview, Angyogdem 1996).

Given the limited laboratory surveillance capacities, the STD programme also depends on clinic-level data for information. In addition to the data management problems at this level, there are serious problems with facilities' recording of specific STD data. Laboratory antibody forms are standardised for HIV tests because it is part of the national screening programme. Other STDs are recorded on general consulting laboratory forms and may not necessarily be recorded as STDs when hospital/clinic reports are drawn up (Interviews, clinic staff 1996-7). The MoH communicable disease reporting forms specify only the categories 'AIDS' and 'Gonorrhoea' (occasionally 'gonorrhoea/other STDs'). The clinic level analysis revealed a high level of inconsistency in the way STDs are being recorded - often as 'Urinary tract Infections' or 'other', therefore disguising the true number of STDs (see chapter 3). As a result, the prevalence figures should be treated with great caution.

Inconsistent recording and poor data management combine to emphasise the fact that the true extent of STDs in Upper East Region is unknown. This has serious implications for policy decisions on future funding and resourcing of STD/HIV prevention and treatment strategies. Staff at each facility were asked to estimate how many STDs and AIDS cases they saw in a month, and through their answers clear patterns began to emerge. All four facilities visited within Bawku, a major three-border trading town, and the large health centre at Paga, another trading town on the main border crossing with Burkina Faso, all reported seeing much higher rates of STDs and AIDS than elsewhere. Also a small private clinic in an area notorious for illegal gold mining activities off the main road leading from Bolgatanga to Bawku, reported seeing a comparatively higher incidence of STDs. All six facilities said most cases they saw were gonorrhoea. Figure 6.5 below indicates STD 'guestimates'⁸² by district. Official AIDS statistics by district show the highest case loads to be in Bawku East and Kassena Nankana, the two border districts and Bolgatanga, the regional capital (GMOH(UER) 1996a, 1997). The 1995 Annual report carries a note that 28% AIDS cases recorded in Bawku East that year were non-Ghanaians from Togo and Burkina Faso.

Figure 6.5 compares official figures from the draft 1996 Annual Regional Report and Regional Hospital report with figures based on 'guestimates' made by staff interviewed on the number of STDs they thought they saw in a month. The national averages are also shown. These statistics are intended to give a indication of the possible extent of STDs in the different districts in Upper East in the absence of reliable official data.

⁸² Asking staff to 'guestimate' how many cases they saw in a month and extrapolating annual figures from this obvious has limitations, but it was felt that, given the serious limitations of official data, such approximations could provide a more accurate (though very rough) picture of the actual cases being seen.

Figure 6.5 Official and Estimated Annual Incidence of STDs and HIV/AIDS in UER, 1995-6

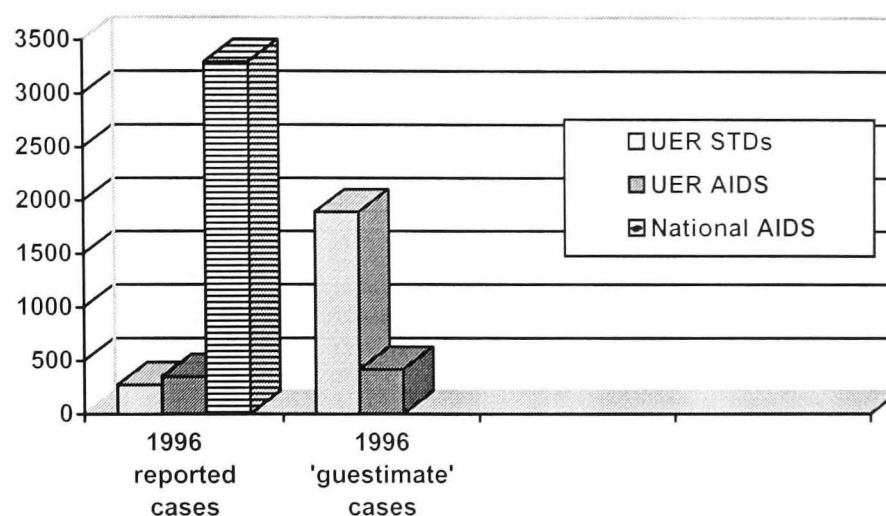

The close total of AIDS 'guesstimates' to actual reported cases reflects the higher level of surveillance and reporting of AIDS compared to STDs. The 'guesstimated' total of STDs is ten times higher with wide variations between districts and sub-districts. National AIDS figures are included as a comparison; the Upper East Region represents 2.8% of cumulative national HIV/AIDS cases, although it accounts for 10.7% of the annual cases in 1996 (GMOH 1997). National surveillance reports include extensive statistics only for HIV/AIDS. There is no national STD total available and no national STD prevalence rate. Research from 1994 suggests a minimum of 1-2% adult population are infected with an STD, but this is considered a significant underestimate (Pellow 1994; USAID 1994b).

6.6 TRAINING AND FOLLOW-UP

Training is arguably the region's most important role and there are many complex issues involved. Clinic analysis indicates that there is limited training in syndromic management for STDs and no follow-up of training. Vertical training initiatives, however, disrupt routine activities and encourage compartmentalised thinking about health care. The lack of funds and inappropriate national/donor decisions contribute to these problems. While the regions' influence on funding procedures and directives may be limited, there are a number of areas where they could play an important role.

6.6.1 Some caveats regarding training

The training deficits for STD management have already been noted, but a couple of points need to be made. Firstly, the term 'training' is something of a euphemism since it rarely

covers anything more than lectures on theoretical signs, symptoms and treatment regimes (personal observations and staff interviews 1996-7).

Secondly, while there are undoubtedly deficiencies in STD/HIV training, health training sessions in general tend to be highly disruptive to routine service provision. Many of the district trainings are externally driven in response to national and regional directives and where staff capacities are low this can be highly detrimental. One public health nurse comments:

'Training does disrupt our work. They should consider the problems of the district more...when the region always dictates to you it's not easy...Once the DMO is told to organise a training he wants to keep to the scheduled date because he also doesn't want to be found wanting.'

PHN, Binaba

In the light of this, the whole rationale for regionally and nationally imposed training needs to be questioned.

6.6.2 Current STD training: national curricula and regional activities

Currently few medical practitioners have a detailed knowledge of STDs when they finish their training since most training curricula do not cover STDs in any depth and none currently provide syndromic management training (MD, MA and Nursing national training curricula as at 1996). Some basic recognition and treatment of STDs is covered in general nursing training. Staff below the level of medical assistant are not taught how to treat STDs, though they may cover what treatments are used, but they are taught how to recognise symptoms and abnormalities and refer. This is covered in the curricula of the Upper East regional Nursing School and the Midwifery Training College both in Bolgatanga (Interview principle SRN School, 1996; Interview principle MW School 1996). Resources at these schools are extremely limited, however, and all STD/HIV related training is theoretical (Interviews with staff and trainees, 1996-7). Registered nurses are trained to be first screens for patients - though the effectiveness of this depends on the quality of provider-client interaction since the screening is entirely verbal and no physical examination occurs.

Regions have an official role in carrying out in-service training and 'training of trainers' in response to national training initiatives. When the syndromic guidelines were produced by

the National AIDS Control Programme in 1993, regional personnel were trained in their usage at Kumasi Teaching Hospital. These personnel were then charged with training district leaders in their own regions. Specialist training on syndromic management has occurred on a limited scale in the Upper East. A three day workshop was held in 1995 for 12 doctors, medical assistants and public health nurses who were subsequently supposed to arrange their own training for staff in their districts.

Funding is a perennial problem. Earlier sections have detailed how the Upper East STD/HIV programme relies on donor funding. The regional STD/HIV co-ordinator feels that donor interests are moving elsewhere and as the 'common pot' initiative does not allow earmarking of funds, the result is that there is little in the system for training under the STD/HIV programme:

'When the [STD/HIV] programme began we got donors. It was a new programme so donors were interested and gave funds for training, and people were trained. That was about 3 years ago, but now the funds have declined because donor money has gone elsewhere.'

STD-HIV Co-ordinator, Upper East

Chapter three indicated the STD/HIV training that has taken place in the Upper East. Of the staff interviewed during the research, 49% said they had received some kind of training on STD/HIV. Of family planning staff interviewed 68% said they had received training; 53% MCH staff interviewed said they had been trained. No systematic follow-up had been conducted in relation to any of these STD/HIV training sessions.

6.6.3 Development of training manuals and participant selection

Apart from the obvious need for regional follow-up of any training initiatives, regions need to make decisions on a variety of training issues such as resources and selection processes. Currently national actors are still taking precedence in these issues leading to further ambiguity in the regions' role.

It is evident from the preceding discussion that most training initiatives come from HQs or donors, who designs the content of training and specify who is to attend. This severely limits the region's autonomy to take regionally appropriate decisions on these aspects. Moreover, for donor and HQ training initiatives, training manuals, agendas and even reports come from

and are taken back to Accra, once training is finished, depriving the region of potential resources and information (Interviews and personal observation 1996-7). A USAID funded training session for 'Onchiames' (male FP motivators), held in 1994, is one example. Training manuals and facilitators came from Accra to carry out the training, and afterwards 'Accra came and took our reports [of the training] away' (Interview, Regional Health Educator 1996).

Sometimes programmes are developed locally, but even then there are problems with building up a regional pool of training material. The training manuals for an initiative held in the Upper East on training community health nurses in STD/HIV education, are not available, because the district medical officers who were asked to develop training schedules for use in their own districts, refused to share them. The Regional Health Educator, who spearheaded the initiative, says the idea was to compile these to keep as a regional level resource, but the district medical officers were not forthcoming; one even insisted he should be paid if he forwarded his plans (Interview, Bodzie 1996).

Those eligible to attend regional level workshops are decided by the regional health management team, or according to specifications from the funding agency (donor, NGO or MoH unit from HQs). At the district level, attendance is decided by the district health management team and the district medical officer. Private practitioners may miss out at both levels. In Bolgatanga district, two well-established private practitioners were interviewed (at Asankunde and Kongo clinics) who had been invited to the regional STD guideline dissemination workshop, but a newly established private practitioner remarked:

'We've had them [training] in the region, but I've never been lucky to go. Anyone can go, but they are selected from head office, so if your name isn't included you don't go...I don't know how you get your name on the lists.'
Unity private clinic, Anaesthetist

It is usually the highest ranked staff who are invited for training sessions and who are asked to conduct training sessions. This leads to high levels of service disruption and needs to be addressed by deploying more of these cadres to rural areas. It would be of particular value to attract more public health nurses, who are already highly trained in family planning, counselling and public health issues.

6.6.4 Streamlining and follow-up

Follow-up of training is imperative to ensure its success. The topic arouses considerable passion among Ghanaian researchers and practitioners. The Navrongo district medical officer and Deputy Director of Navrongo Health Research Centre declares:

'Training for training's sake is useless...If the trainers come back and ask questions - "but we taught you this 6 months ago why isn't it being done?" then people would sit up, but they just come once and don't return.'

Navrongo DMO

There has been no follow-up of the syndromic management trainings or of any other recent training in reproductive health. The usual reasons given are lack of time and funds, termed as 'logistic constraints'(Interview, Angyogdem 1997). Other vertical directives coming from Accra also claim time and funds from follow-ups which should be routine. The 1996 training calendar of the regional health management team included a follow up of the 1995 regional STD workshop, but other activities (notably the Meningitis outbreak and the Polio immunisation campaign) claimed priority. Follow-up was 'intended' for 1997, but again were not carried out though no specific reason was given (Interview, regional SMO(PH), 1997).

When national trainers themselves come to the region, follow-up remains a problem:

In Accra there are funds for training so they do it... People come from Accra to Navrongo train and then go back and that's the end of it...If they are not going to follow up they shouldn't come to Navrongo at all.'

Navrongo District Medical Officer

According to the District Medical Officer of Navrongo, this is because ‘the people in Accra have too much on their hands and try to take on too much’ (Interview, Navrongo DMO), but funds are not allocated to the regions to carry it out themselves.

The region currently has no jurisdiction over the timing of in-coming funds and directives for training. As decentralisation and the pooling of donor funds progresses, the region may be able to assert its autonomy over what funding for training is accepted and when and so streamline initiatives to regional priorities and needs.

6.7 TREATMENT MANDATES, HEALTH EDUCATION AND WIDER NETWORKS

6.7.1 Treatment hierarchies

A clear finding at the facility level was that MCH/FP staff are rarely allowed to treat STDs. A restricted view of nursing mandates is upheld by regional personnel. The Regional Pharmacist, cited earlier, maintains that no nursing staff are allowed to prescribe STD drugs. The Acting Principle Nursing Officer, who has direct responsibility for MCH/FP services in the region, comments:

‘basically, our level is health education and then, if there is a PHN that is manning [the facility] she can give prescribed treatment for some STDs. But basically ours is health education and then trying to detect or diagnose the situation and then refer to the appropriate person.’

These views are influenced by medical practice hierarchies from national level professional bodies particularly the Nurse and Midwives Council (Interview, Secretary, NMWC 1997), although policies state that general nursing staff can give STD drugs if they feel confident in their diagnosis. As it is STD management by lower cadres means referral of symptomatic patients to a superior practitioner and giving education-information on the topic - which is low priority.

6.7.2 Health education

Previous chapters have indicated the dearth of health education and information-awareness activities in the Upper East region. This was largely due to low regional prioritisation (in the face of limited resources and more immediate clinical priorities), few resources and poor

transport facilities. In addition, there are few appropriate educational resources (like visual aides) for use in northern Ghana and female nurses feel they are not the appropriate personnel for talking to males in the communities about contraceptives and STD/HIV risks. This section considers the possibilities for addressing these through wider collaborative networks.

Health education: low priority and crisis orientated

Although there is growing concern nationally about the incidence of STDs/HIV in the border towns of the Upper East (Interviews, Action Aid, Care International, UNAIDS 1996-7), the immediate health education worries for the regional health administration over 1996-7 were linked to outbreaks of meningitis, yellow fever and vertically directed polio eradication vaccinations. Regional health education programmes do not involve much on STDs and HIV/AIDS because 'at any one time the emphasis is on the key problem at that moment' (Interview, Bodzie 1996). The other major reasons, noted in earlier chapters, are the lack of transport and financing. Given these constraints, linking with other actors can be vital.

6.7.3 Wider networking potentials

The regional health management team is supposed to have contact with a number of other sector ministries as well as NGOs and church organisations working in the region, which could be, or are already, involved in STD/HIV prevention. The main sector ministries linking with MoH are shown in the organogram in section 6.2 above. These links are particularly important in the bid to address health education issues and wider health priorities like food and water/sanitation issues. NGO and church links are mainly operational at district level, where their benefits were noted in previous chapters. The main significance for the region is in co-ordinating links with them and other sector ministries, though section 6.2 indicated that co-ordination mechanisms are currently ineffective.

Perhaps the most important sector links for the area of reproductive health are with the MoAgriculture, particularly networking with their Extension Officers who are trained to give FP messages and undertake condom distribution in the localities. Through these Officers, Agriculture is more represented on the ground than any other ministry providing a marvellous opportunity to reach villagers on health issues in their own environment. Characteristically there has been no follow-up of the condom initiative, Agriculture sees that as 'someone else's responsibility' (Interview, regional Deputy Director, MoAgriculture, 1997). The Regional agriculture extension officer says 'there were hiccups introducing

condoms into the villages - some [officers] think it's too much' but 'they were popular' as were other health talks:

'We have feedback every two weeks from the district officers - we found that health was the most welcome topic among the farmers...that taught me something - it makes much impact talking to your peers.'

Regional Extension Officer 1997

The MoAgriculture has shown willingness to co-operate with the MoH on a number of issues, particularly FP and water-borne diseases, although the regional director's office is clear that for projects which may involve MoH collaboration 'the funding divisions are very sharp...If there is a health problem [MoH] is supposed to budget and fund' (Interview, Ayariga 1997).

6.8 SUMMARY

There are good networking opportunities at the regional level, and there is regular contact with the districts through the District Medical Officers, therefore awareness of district level difficulties is high. Despite this it is clear that the regional health administration is unable to effectively address many of the contextual issues identified at the facility level around funding and resourcing, training, drugs supply and support for health education and wider community health initiatives. The discussion of this chapter leads to a three-fold explanation of why this should be so:

- The region has few disposable resources and is faced with a variety of bureaucratic and funding constraints which result in the continuation of the infrastructural, training and medical supply deficiencies observed at the clinic level.
- The roles and responsibilities of the region, both in terms of the overall health policy process, and of 'integrated' programme management, are ambiguous. The intention to bypass regional financial autonomy under decentralisation reforms contributes to the region's insecurity and ambiguity of purpose.
- Concepts of power revolve largely around money and there is less importance attached to data management, reporting, monitoring/evaluation and collaboration responsibilities which are currently weak. This helps to perpetuate vertical reporting and administration systems dominated by national decision makers and

local 'big men' which encourage compartmentalisation of thinking and service delivery and are not sensitive to local contexts.

Clearly many of the bureaucratic and funding constraints experienced by the region are beyond their control. Vertical directives and resource flows come from the national level which is the apex of the policy process. The national level offers the final layer of insight into how contextual factors influence policy and why many vertical structures and processes are being perpetuated despite the 'decentralisation' and 'integration' rhetoric of 'health sector reforms'.

CHAPTER SEVEN: NATIONAL STAGE, MULTIPLE VOICES

*'The right to be heard doesn't include the right to be taken seriously'
Senior Ministry of Finance official 1996*

Despite widespread rhetoric and increasing theoretical support for integrated reproductive health programmes, the analysis of the preceding chapters has confirmed that programme structures are still predominantly vertical and reproductive health policies have not been realistically operationalised. District and regional health administrations have difficulties improving matters. In this chapter, explanations for the gap between policy rhetoric and implementation are suggested; they are threefold. They lie first, with the absence of district and sub-district level voices in the national policy making arena; second, with donor powers and the nature of donor support; and third, with the Ministry of Health, its internal hierarchies and attitudes of key decision makers. Together these provide the 'soft', less palpable context in which policy decisions are taken at the national level and are explored over this and the next chapter.

At the national level, regional representatives join a whole plethora of voices from many different quarters. Before an introduction of some of these wider voices, an analysis of the current reproductive health policies and programme structures is provided, setting out the systems-management context of policy development. This illustrates the arena in which regional personnel have to make themselves heard and highlights each of the three themes of the national level analysis. Finally, the wider arena is presented as an ostensibly democratic environment which on closer inspection reveals serious limitations.

7.1 POLICY DEVELOPMENT AND PROGRAMME STRUCTURES

There are few direct policy statements on health in Ghana and as in most countries, there are few actual legal policy statements on health. Under the current (1992) 'democratic' constitution health is not listed as a constitutional right for Ghanaians although education is. What may be termed 'policy statements' are documents resulting from multi-party discussion fora which stand as MoH policy despite not being ratified in law. These 'policy development' fora are often donor funded and initiated (at least, donor pressure may be put on government to develop a policy in a particular area and so a 'policy development' seminar or workshop is convened). They include a great variety of actors including ministerial,

professional, religious and academic groups and individuals. These venues serve to get issues onto discussion agendas and can result in the generation of policy statements of strategy development by MoH personnel usually with a promise (or an understanding) of external funds. This section first outlines the development of 'integrated reproductive health' as a policy concept in Ghana, then describes the development of MoH structures and programmes. Each part draws out the dual influences of donors and MoH personalities on the current nature of MCH/FP and STD/HIV programme strategies.

7.1.1 The rise of Ghana's reproductive health policy vision

The introductory chapter describes the rise of 'reproductive health' on the international agenda. The following analysis of the birth of the concept in Ghana illustrates many of the themes highlighted there.

As in the international community, Family Planning - Mother and Child Health (FP/MCH) services and Sexually Transmitted Diseases - HIV (STD/HIV) services have received very different treatment from national policy makers. Family planning has long been on the policy agenda of successive governments and has received substantial donor funding since the 1970s. It has never received priority status however, and historical complexities in co-ordination and responsibility often led to conflict and fragmentation, ambiguities and neglect in government policy and programmes (GoG 1991). After family planning was integrated with MCH services in the 1980s as part of the primary health care initiatives, results were poor⁸³ and a variety of research was commissioned. Donor, NGO and national initiatives proliferated to boost the family planning programme. By contrast, STD/HIV programmes have only really developed in the 1990s and still have a significant bias towards testing for and preventing AIDS. The two programme areas are physically and logistically separated. The National AIDS Control Programme (also responsible for STDs) is located in the Disease Control Unit of the MoH under the Epidemiology and Communicable Diseases Division at the main teaching hospital in Accra, Korle-Bu. The MCH/FP Unit is located in the main Ministry of Health buildings on a different site in the middle of Accra.

The first serious move towards more integrated reproductive health services in Ghana came in the early 1990s. In 1992 the MoH held the First National Consultative Meeting on Safe Motherhood, with funding from WHO. This seems to have been an MoH initiative (they went direct to Geneva), though it was undoubtedly influenced by the UNFPA and UNICEF

⁸³ This is detailed in section 2.4. chapter two.

emphasis on safe motherhood. After this, a Task Force was set up within MoH to draw up clinical protocols on all aspects of MCH including management of STDs over a 2 year period, after which a second Meeting was convened and the guidelines discussed and agreed. The Safe Motherhood Guidelines, produced by the MCH unit in collaboration with UNFPA, UNICEF and WHO in 1994, date from the same time that NACP was drawing up its guidelines for syndromic management of STDs. Despite this, there is no reference to syndromic management in the MCH guidelines, nor have they been updated since syndromic management became the official paradigm for STD treatment at district and sub-district levels in 1995/6. By contrast, the new drugs recommended for Gonorrhoea *are* included in the Safe Motherhood Guidelines, though they were not finalised on the Essential Drugs list until 1995. Syndromic management has now been adopted by MCH in its Reproductive Health Policy and Standards document, although it is the clinical Safe Motherhood Protocols which remain the only disseminated practice document.

The main policy document on reproductive health is the 1996 Reproductive Health Policy and Standards (RHPS) Document⁸⁴. This document was drawn up following the usual procedures - working groups in seminars and plenary sessions with major stakeholders (funded by USAID). UNFPA and USAID were involved in family planning and AIDS issues; UNICEF was involved in the AIDS and Safe Motherhood areas; other stakeholders, notably Ghana Registered Midwives Association (GRMA) and doctors as well as MoH officials were also participants. It is no secret however, that the central driving force was USAID. The development of a Reproductive Health policy was a condition of their GHANAPA⁸⁵ agreement, and they have been forceful in pushing their agenda. According to their own Health and Population Director 'we basically did it all' (Interview, USAID 1996). DFID's reaction was that 'USAID really rammed it down the throats of MCH' (Interview, DFID 1997). There was initial resentment in the MCH unit, but, as DFID's Head commented 'now they have it, I think they feel proud of it' and at a meeting on policy development in 1997 the MoH held up the RHPS policy as a prime example that things were moving (Interview, DFID 1997). The process may have caused more resentment at a higher level, among the 'big-men' in the Ministry and the hostility of the then Director of Medical Services towards reproductive health, may well be a backlash against USAID's aggression in pushing their RHPS agenda.

⁸⁴ See Appendix 3 for the content of this policy document.

⁸⁵ USAID's current five-year aid programme running from 1996-2000.

While donors and the MoH express satisfaction with the current reproductive health policy, dissenting voices come from NGO quarters. A senior official in Save the Children Fund's (SCF) health section was very critical of the RHPS document:

'It's a clinical protocol not an integrated policy...it doesn't tackle cultural, political and economic issues affecting reproductive health...it is a health workers policy rather than a peoples' policy. In fact it started as a family planning policy, then after Cairo⁸⁶ they called it "reproductive health"'

Interview, SCF 1996

SCF's reproductive health spokesperson questions the inclusiveness of the policy development seminar she went to which was attended predominantly by doctors and representatives of two national NGOs well connected with the government. SCF believe that because of the external agendas, the resulting document was limited.

'The document doesn't incorporate the Cairo recommendations - it had no hope of doing so because it worked from a standard protocol...I was very disappointed and just didn't have anything to do with it in the end...integration and reproductive health is all lip service'

Interview, SCF 1996

The policy is typical of many - the detailed paper document, delineating ideal policies with all the required rhetoric, is accompanied by no realistic assessment of how they are to be carried out within given structures and constraints. After I expressed concern that there were no indications as to how the policies were to be implemented, it was stated by both USAID and DFID that there was an accompanying document on 'Strategies and standards', but no one could produce a copy. Eventually the Head of MCH said that no such document had in fact been published⁸⁷ - all the information was in her head, and scattered through various other documents. The main practice manual remains the Safe Motherhood Clinical Protocols.

This brief analysis has already highlighted three key issues. There is dominant leadership from the donors; there are parallel and non-communicating structures in the MoH; the dissenting voices are sidelined while the voices of the implementors, which are crucial for devising and communicating implementation strategies, are not heard at all. Before exploring

⁸⁶ The UN Conference on Population in Cairo in 1994.

⁸⁷ Since these interviews, an operational manual has been drafted, but it has not yet been widely disseminated and at the time of writing a copy was unavailable.

each of these in depth, a closer analysis is made of the current institutional and programme structures which provide the practical structural context for policy implementation and help to explain why directives on STD, family planning, immunisation and other aspects of MCH are separate and vertical by the time they come into the regions.

Given the vested interests in current parallel structures, the potential benefit of an independent co-ordinating structure has been acknowledged and we turn briefly to the National Council on Population, before a detailed consideration of the Ministry of Health itself.

7.1.2 The National Council on Population - inhibited potential?

The National Council on Population has been heralded by some as a potential co-ordinating body for population related areas like reproductive health which span several units within the MoH (personal communications, 1996 and 1997). However, it has still to establish itself on the national stage and command the co-operation of the full cast of actors. Population and family planning programmes have been through a number of incarnations and the metamorphosis of the Ghana National Family Planning Programme (GNFPP) into the National Council on Population is indicative of internal power struggles, and donor pressures and conditions which may render it ineffective in co-ordinating reproductive health activities.

Family planning in Ghana

Although Family Planning now comes under the MCH unit of the Ministry of Health, population policy - including family planning and reproductive health - is still influenced by the NCP which, as the highest statutory body on population issues, has an official mandate to 'advise Government on population and related issues' (Population Act 1994). Despite being linked, since independence, to national development, population programmes have not been a government priority (UN, 1979; GoG 1991). Formerly, family planning came under the Ghana National Family Planning Programme which enjoyed strong USAID support. It was vertically driven, influenced by the national central population programmes of the Far East, and produced its own training and practice manuals. MCH staff were seconded from the MoH for FP activities under the programme. Conflict developed between the director of the National Population Council (of the GNFPP) and the head of the MCH who felt that they (MCH) should be leading FP implementation. This resulted in the MCH unit taking its staff away from the GNFPP programme and adding FP onto MCH by training their own nurses in

FP as an extra. MCH is essentially maternity focused and this action has perhaps marginalised FP to the female domain of maternity issues.⁸⁸

Table 7.1 below shows that USAID and UNFPA, perhaps exploiting the internal conflicts, were simultaneously pushing their own agendas to reform and re-structure Ghana's population and family planning programme. It also indicates how lengthy the process was.

Table 7.1 Donor influences on the reform of Ghana's Population and Family Planning Programme

Date	Actor	Action
1988	UNFPA	Conference on Population - recommended establishment of a 'National Population Commission'
1989	UNFPA	Funded a major population conference which called for a review of the 1969 population policy
1989	GoG (MoH)	Population Implementation and Assessment Committee inaugurated as interim body to advise government on population activities pending establishment of a National Council on Population
1991	UNFPA	Programme Review and Strategy Development report of UNFPA's First Country Programme recommends review of 1969 policy
1992-5	UNFPA	Policy revision is a formal recommendation of the Second Country Programme
1991-5	USAID	Reform of population policy stated as part of FPHP agenda Formation and permanent functioning of NCP becomes a condition for aid
1992	GoG	National Council on Population formally inaugurated.
1994	GoG	National Population Policy revised - mandate established in National Population Council Act 1994
1995	NCP	Secretariat formed
1995-2000	USAID	Continued operation of NCP is a conditionality of GHANAPA agreement
1995-2000	USAID	Monthly Population and AIDS Co-ordination Committee, chaired by NCP, established as a condition of the GHANAPA agreement
1995-2000	UNFPA	NCP to be the major co-ordinating body for the Third Country Programme

Although population activities in the MoH are co-ordinated by NCP, the memory of old feuds lingers and at times there is evident tension between them (interviews 1996-7, personal communications and observation). UNFPA is concerned at the 'unclear institutional

⁸⁸ A senior official and medical doctor says 'actually MoH nurses, midwives and medical students get very little training in FP because it is just tagged on to the MCH activities. Now they are running courses for all sectors and categories of health workers, but FP is still by and large, a specialised topic.' (Interview, Adjei 1996).

relationship between the NCP and the line ministries' (UNFPA Third Country Programme 1994:21). There are still internal wranglings over where responsibility for population policies should lie and the placement of the NCP directly in the Office of the President, outside the MoH, was a compromise (Interview, Aikens 1996; Interview, Adjei 1997; Interview, Quist-Therson 1997).

The heads of MCH and NCP are both strong personalities, and both find it hard to delegate. These are two key players in integrating reproductive health services and conflict between them may impede any coherent co-ordination of integrated programmes. MCH is strong, well established and has close working relations with donors and some of the NGOs. The NCP co-ordinates the two major donor programmes which involve practically all actors in the field of health and population: USAID's GHANAPA and UNFPA's Third Country Programme⁸⁹. To access those funds MCH technically has to go through the NCP. This has worked in NCP's favour; its Director says that in the past, some MoH sections were unwilling to work through the NCP, but now 'the various line ministries know that if they don't come through us they won't get the funding, so they are being forced by the sheer fact that the donors would like us to be together rather than to be moving separately, they are being forced to co-operate.' (Interview, Turkson 1997). The establishment of a Technical Advisory Committee on Reproductive Health was another attempt to bring MCH(MoH) and NCP together (Interview Quist-Therson 1997). The MCH Head chairs the committee and the head of the Reproductive Health Unit in the NCP is the Secretary.

The Council is considered by some to be too new to have consolidated its role in co-ordination of reproductive health activities, although its secretariat has been in operation since 1994 (Interviews 1996-7). The NCP does provide a legitimate voice on population issues and is a visible player in policy debates. The NCP's significance lies in its potential as an advocate for integrated reproductive health policies and its ability to co-ordinate funding and activities to achieve them. If it can bring NACP, MCH, donors and the other actors in reproductive health, including the providers, into closer working relations, it will be a substantial step for co-ordinated reproductive health policies. Its internal hierarchies, however, and the donor programme frameworks within which it works, provide severe constraints and it remains to be seen if it can really provide much more than an information sharing venue and rhetoric to promote particular policies.

⁸⁹ A series of committees and sub-committees have been established to deal with different aspects of these.

7.1.3 MCH/FP and STD/HIV programmes

The nature of Ministry programme structures and organisational management indicates the practical, physical context of policy formulation and implementation. This is described first with some discussion of the influences of power preservation and staff tensions on programme structures. This is followed by more detailed analysis of how donors and MoH together exacerbate and perpetuate the current nature of programme structures and organisation.

Ministry programme structures and vertical organisation

In the Ghana health service, medical services in general are provided under three broad areas: Clinical, Public Health and Maternal. Problems of organisation and communication are especially pertinent for programmes like reproductive health which span all three areas. Thinking is very compartmentalised at the national level with programme guidelines cutting across these conceptual areas in more vertically conceived activity specifications. Such non-integrated thinking is recognised as causing serious problems at the implementational level, particularly for programmes like managing STDs within MCH/FP which require both clinical and public health activities. The problem is magnified because STD policy is made in the Public Health Division but is implemented by clinicians on the ground, whose clinical needs are overseen by the Institutionalised Care Division:

'clinicians on the ground have no links with STD policy making because that's all done by the Disease Control Unit, [which is in public health not clinical services]...The problem with separation is that MCH/FP and STD/HIV are managed separately from the top, so the lower level people looking up see no links at the top level and therefore see no reason why they should link on the ground.'

Director, Health Research Unit 1997

The need therefore to include implementors in policy discussions is recognised:

'people trained as prototypes to implement the policies also need to be involved in policy making, so they have perspectives from the ground.'

Director, Health Research Unit 1997

There is some competition between the different Divisions of the MoH with some Public Health Division (PHD) staff feeling that there is a bias in funding towards the clinical Institutional Care Division (ICD) (Interview, Odoi-Agyarko 1997). It is a claim difficult to verify since the nature of funding is different between the two. Public health receives more in donor aid, while funding for the STD programme comes solely from the Public Health Division. Even where support for clinical services has been given, this was funded by donors through the Public Health Division. Links and communications between the two divisions are likely to be confounded by the operation of the Ghana Health Service⁹⁰ which will increase the number of necessary communication flows.

Both STD/HIV and MCH/FP programmes come under the Public Health Division which is considered to be the strongest Division within the MoH (Interviews 1996-7). An analysis of the creation of this Division illustrates the power of international aid ideologies which emphasised primary health and the bid by the MoH to gain as much as possible from this. By 1993 a new unit called 'Technical Co-ordination and Research Division' had been formed, headed by the then Deputy Director of Health Services, Dr Adamafio. This unit took under its wing all technical units of the MoH as well as the programmes under MCH, Disease Control and Health Education. Soon after this, TCRD was split into 'Public Health Division' and 'Institutionalised Care Division'. According to a senior official in the Policy Planning Monitoring and Evaluation (PPME) division, hospital-based care was separated from the so-called 'public-health' or primary health care institutions in order to secure maximum international funds designated for primary health care initiatives. MCH, Disease Control and Health Education were all placed under Public Health, though the former two involve a great many clinical activities, because 'once the issue is of public health importance it jumps into the public health domain' (Interview, Bughri 1997) which has higher priority with external funders.

The strength of the Public Health Division was consolidated when at the time of its creation 'the MoH decided to appoint Public Health staff to [senior ministry] positions'; and the driving force behind these initiatives was, as the First Deputy Minister implies, the increasing emphasis by donors on primary health including clinical management of diseases of public health importance: 'WHO places more emphasis on public health than clinical services...There's been much donor assistance put into public health' (Interview, First

⁹⁰ The Ghana Health Service was set up by an Act of Parliament in 1997, creating a policy-executive split in the organisation of the Ministry of Health. The MoH will remain a purely policy making body; the GHS will implement and oversee the policies. The structure of GHS largely replicates that of the MoH and there is concern that this may result in competition rather than co-ordination in health policy processes.

Deputy Minister 1997). The influence of WHO in this instance is particularly pertinent since it is WHO which supported the development of PPME's Director and others, and maintains a close interest in the health system from Geneva through particular consultants⁹¹.

The strength of the MCH unit relative to other units within the Public Health Division can also be linked to heavily weighted donor aid bias to MCH: for immunisation in the 1980s and safe motherhood in the 1990s. This is easily justified in-country and the last MCH Annual Report (1995) cites the reasons for prioritising mother and child health: mothers and children suffer the great majority of illness and death, most of which is preventable and they constitute 70% the population which represent considerable resources for national development but are 'silent' in their needs (GMOH 1996a:1).

The other Divisions are largely of peripheral importance to national level reproductive health policy and activities. The areas they cover - clinical procedures, training, drug and contraceptive supplies - are vital for STD management, but policy and practice decisions involving MCH/FP staff are taken by (or in consultation with) the MCH unit, and any policy issues relating to STD/HIV management are dealt with by the National AIDs Control Programme. There appears to be limited effective communication between the national Divisions (Interviews and personal observation 1996-7) and their role is generally concerned with the development of national policy and guidelines in their assigned category and keeping an overview of the activities of other Divisions and Units in these areas. These roles are likely to be consolidated when the Ghana Health Service, set up by the Ghana Health Service Act (July 1997), takes over all executive activities.

The MCH/FP and STD/HIV programme structures are indicated in the table below. They have developed independent organisational structures and are separately managed and funded.

⁹¹ In particular, Cassells, an independent consultant and Janovsky, a WHO staff member, who frequently publish together, claim a certain exclusivity to health research in Ghana (personal observations and communications 1996-7).

Table 7.2 MCH/FP and STD/HIV Programme Structures

Level	MCH/FP Programme structure	STD/HIV Programme structure
National	<p>Population Council develops FP policy and guidelines MCH Unit, MoH, develops MCH and reproductive health policy and guidelines.</p> <p>Funds and supplies from GoG, donors, Ghana Social Marketing Foundation (GSMF). Annual support visit to districts.</p>	<p>NACP develops policies and guidelines</p> <p>c.90% funds from donors</p> <p>Some supplies (HIV and some other STD reagents) from donors</p> <p>Support visits to regions on demand</p>
Regional	<p>Regional PNO (MCH) oversees monitoring and management.</p> <p>Half yearly returns to MCH HQs (via RHMT)</p> <p>Half yearly support visit to districts</p>	<p>Regional AIDS co-ordinator and Regional STDs co-ordinator oversees district activities</p>
District	<p>DHMT District Nursing Officer I/C MCH oversees MCH/FP delivery.</p> <p>Quarterly support visits to sub-district teams</p>	<p>District AIDS Co-ordinator/ Disease control officer oversees STD/HIV services</p> <p>District AIDS committees (fora for discussion between MoH, sector ministries, NGOs, communities)</p>
Sub-District	<p>MCH/FP staff deliver services</p> <p>Service delivery by MoH, PPAG, CHAG and NGO/Mission clinics and health centres.</p> <p>Quarterly Reports from Nursing Officers I/C to DHMT</p> <p>Monthly support visits to TBAs and outreach services</p>	<p>SDHMT - disease control officers and OPD staff deliver services. MCH/FP staff also deliver, under auspices of MCH.</p> <p>Nursing Officers I/C clinics oversee activities.</p> <p>Reports monthly and quarterly to DHMTs</p>
Community	<p>TBAs and MoH staff on outreach PPAG CBDs</p>	<p>Outreach and co-opted members of the community involved in AIDS awareness activities (less for STDs)</p>

In Ghana, as we have seen at the sub-district level, MCH/FP services constitute a major part of medical service delivery⁹² with most clinics offering services under 'MCH-FP' and 'OPD'. The head of MCH takes direct responsibility for the development of all maternal and child health services which are defined as 'incorporating all safe motherhood, child survival and family planning⁹³ [activities]' (GMOH 1996a:1). The facility analysis has shown how, in reality, these three components are divided - often by physical location, staff and sometimes days and times of delivery.

STD and HIV/AIDS programmes come under the Disease Control Unit, also in the Public Health Division. The Disease Control unit is too diverse for its Director to take direct responsibility for all the various programmes, so the National AIDS Control Programme (NACP) was given its own Director, who reports to the Disease Control Director. The NACP retains a certain amount of independence as a priority programme of the Government, although as a programme rather than a separate unit it does not have the same power or status as the MCH Unit.

The establishment of the National AIDS Control Programme in 1986 (though its functioning was limited until 1990-1 when support was expanded) was largely in response to pressure from WHO under its Global Programme on AIDS⁹⁴ as well as a desire to effectively harness all potential funding. NACP was to address the growing AIDS problem and directly manage incoming funds. Its main achievements to date have been the revision of the Essential Drugs List to include Gonorrhoea-effective drugs (an aid condition imposed by USAID) (FPHP/GHANAPA Project Document, USAID 1994), the establishment of a national HIV surveillance programme at 7 sentinel sites (another USAID condition) and the production of STD guidelines on STD management using the syndromic management approach.

Although NACP is the national STD/HIV policy making body, any attempt to integrate STD/HIV management into an MCH/FP package would be undertaken by the MCH unit, with collaboration from NACP in terms of management guideline development. NACP is supposed to co-ordinate all AIDS related activities, so MCH is theoretically expected to go through them in its inclusion of STD/HIV management activities. In practice the head of the MCH unit claims responsibility for STD/HIV activities within her programmes. She regards NACP as narrow in focus - 'they think about the burden of disease, we think about

⁹² To the extent that the MCH head remarked 'we are primary health care' (seminar discussion, 1997).

⁹³ The FP programme was formerly a separate programme. See the section on the development of the National Council on Population for details on its transformation.

⁹⁴ WHO's GPA urged all member states to establish national AIDS programmes in response to the epidemic. WHO were instrumental in outlining the structures and mandates.

reproductive health care' (Interview, Odoi-Agyarko 1996) - but recognises the need for collaboration:

'It's unfortunate that we've separated diseases from the unit...but I think that it's time that we make one sort of document, especially for those working at the sub-district level.'

There is certainly a commitment to integrating STDs into family planning services, and there has been some attempt at collaboration with NACP, indicated in the pilot training of FP staff in STD management in Eastern region⁹⁵. The issue of integrating STD management into ANC (except for syphilis screening), or any of the other 'MCH' component services however, is not seriously addressed (aside from the lip-service paid in the Safe Motherhood Clinical Protocols) and is not favoured by the head of MCH who prefers to ringfence the different activities and observes that 'We must focus or it will spoil our whole programme'.

Donor influence and MoH response: exacerbating the splits

We can already see that MCH/FP and STD/HIV programme structures are separated. External donors influenced the establishment of the NACP and the re-structuring of the MoH which allows for public health and MCH dominance. The situation is consolidated by internal MoH figures being keen to preserve their own arenas of power. These dual influences have also had a profound impact on the content and development of STD/HIV and MCH/FP programmes.

Table 7.3 below, shows the main donors in the health sector and the programmes they fund. It indicates clear groupings of donors assisting particular programmes. The external Aid Co-ordinator comments that this is 'particularly so for MCH and AIDS because they were popular with donors.'

⁹⁵ This is a Johns Hopkins (JHPIEGO) sponsored project bringing together the head of MCH (who has overall responsibility) and the head of NACP (in an advisory capacity). Communications between the two on the progress of the project (implemented by MCH) seems good (Interviews head MCH, head NACP 1997).

Table 7.3: Major donor in HIV/AIDS and STDs and MCH/FP

Donor	Programme, timeframe and geographical area	Amount pledged and time-frame (US\$ unless stated)**
USAID	GHANAPA (population and AIDS) 1995-2000 National	45 m of which: 31m project assistance (including 11m contraceptives) 14m non-project assistance
DFID	health and AIDS 1993-1996 National and Volta Region	£20 m (£509 000 support to NACP 1995-6)
CIDA	HIV/AIDS/STDs 1996-2000 National	C\$ 200 000
WHO	health and AIDS 1993-1995 National (and technical support to NACP)	2.7m
DANIDA	health and AIDS 1993-1998 Upper West	22.4 m (8m support for PHC training institutions; 4.7m National TB control programme; 9.7m support for PHC programme in UWR)
UNDP	AIDS 1996- National	500 000 (through WHO and NACP)
UNAIDS*	AIDS 1997-2000 National	In excess of 3m *
UNFPA	AIDS and FP (3rd Country Programme) 1996-2000 National	25 m + contraceptives and basic equipment
Unicef	AIDS, Population/FP, Safe Motherhood 1996-2000 National	13 m
World Bank	health, population/FP 1992-1995 National	27m
JICA (Japanese Government)	population/FP 1994-1997 National	Yen 80m With UNFPA

Source: Donor country documents; MoH budget sheets 1995-6.

* The UNAIDS budget will incorporate the AIDS budgets from its co-sponsors: Unicef, UNDP, UNFPA, WHO and World Bank

** Budget and finance data are often complex and very difficult to interpret, thus there are inevitable limitations in the financial information presented here.

AIDS vs. STDs

AIDS continues to attract substantial international resources. Donors to NACP predominantly focus on AIDS to the neglect of other STDs which were later added to the programme's mandate in the climate of integration led by WHO (see the review of the literature in chapter two). The AIDS donors tend also to focus on clinical rather than public health activities and their funding allocations are area-specific. USAID have given support for strengthening laboratory capacities⁹⁶, as have DFID, and provide reagents for HIV sero-surveillance. DFID, the World Bank and DANIDA all support related clinical activities and capacity strengthening. UNDP and the Dutch and German governments have also been involved in funding clinical AIDS activities. UNAIDS is set to become the lead AIDS donor in the next few years, co-ordinating the AIDS sector inputs of all the other UN agencies. Most funds for STD/AIDS are channelled through NACP and in 1994, NACP reported that approximately 80% of MoH non-personnel expenditures for AIDS/STD control activities were funded by external donors. In 1997, DFID estimated that 98% NACP expenditures were donor funded, the largest being USAID through its non-project assistance. The most significant funder of STD activities, particularly IE&C, is the European Union, whose programme has now terminated.

The AIDS bias in funding is acknowledged in the MoH and the former Director of Disease Control remarks:

'[AIDS] tends to be isolated and get much more support. STDs do not get so much support and recognition at the national level...I am advising NACP to use AIDS as a carrot to attract resources [for STDs].'

Former Director Disease Control, 1997

A senior Ministry of Finance official points to the necessity for flexibility of donor funding:

'You need to understand that if somebody has been given money for HIV and he is using it in the area of STDs, he's not committing a crime. The funding should be flexible enough to take account of this.'

Senior Ministry of Finance official 1997

⁹⁶ USAID's current health desk Director is not in favour of AIDS support, saying that USAID was 'pushed into collaboration with STD/AIDS because of the link with condoms' (Interview, Halliday 1997). He sees USAID's expertise and primary remit as FP.

STDs have not been national priorities either and incoming donor funds were seen as the only way round this. The former Disease Control Director said the main problem facing the STD programme was financial 'because it depended on who was [Director of PHD and DMS] and whether they thought it was a priority. But at that time we could extract external funding...and be independent of GoG funds' (Interview, Bughri 1997). National decisions are centralised and for a non-priority programme like STDs this affects all areas of programme support. For example, centralised training decisions mean numbers and fellowships allocated for STDs are minimal, creating huge problems for building district capacity (Interview, Bughri 1997). Again the Ministry Directors say 'the way around it is external funding.' Aside from the lack of donor funding, the former Director of Disease Control believes another major reason for the lack of importance designated to STDs is the lack of data on STD prevalence which might shock people into support:

'The problem we have in making decisions is data. To make STDs a priority disease we need data to say that 98% infertility is caused by STDs...If we could say to men 30% of you will have your prostates removed because of STDs they'd stand up and take notice.'

Former Director Disease Control, 1997

Reasons for the national lack of interest in STDs, are hard to dis-aggregate from the counter-incentive of donor bias to AIDS over STDs. A UNFPA official was adamant on this point, saying the MoH is making 'a big mistake' in not addressing STDs beyond their significance for HIV transmission. He lays much of the blame for the over-emphasis on AIDS and perpetuation of vertical programmes with donors, particularly USAID and DFID, because 'they pump monies into specific programmes which encourages the strengthening of vertical mechanisms, and specific programmes become big...UNFPA hasn't given money for AIDS specifically for that reason' (Interview, Owusu-Sarfo 1996). UNFPA, reflecting its own strong bias for family planning, prefers to channel its aid into the MCH unit.

Population, Family Planning and MCH

For population and family planning activities, the main donors are USAID, UNFPA, Unicef, World Bank and the Japanese government. Monies are channelled in various ways, much of it coming to the MCH unit of the MoH, which is a major implementing agency for the country programmes of USAID and UNFPA, although increasingly, funds are going to the private NGO sector (especially USAID funds). Unicef and DFID collaborate with MCH in safe motherhood and reproductive health; the MCH unit is a major implementor for donor

programmes in these areas. Family planning in particular attracts considerable donor funding and in-kind support which finds its way right to the district level.

MCH is keen to preserve its own lucrative revenue and this has led to a latent suspicion of genuinely integrated programmes. SCF and DFID note the MCH head's dislike of the term 'reproductive health' as too broad and threatening a wider-than-unit disbursement of funds previously secured for MCH. The Unit readily expresses concerns over the wider integrated approach:

'We've many impediments because of integrated services. Our vehicles are taken away...If it was separate we'd be doing a lot more.'

Director MCH Unit, 1997

These attitudes of national MoH officials also help to perpetuate the split between family planning and information-education which are public health activities, and the other safe motherhood components (ante-natal and post-natal care) which are provided by clinical staff, often in different locations. Despite integration rhetoric, donor support also contributes to this. Apart from the international advocacy for syphilis screening in ante-natal care (a policy accepted by Ghana's MoH), most international debate on integrating STD/HIV management into MCH/FP does in fact focus on family planning, or vaguely discusses 'total reproductive health services' ignoring the realities of separated FP and MCH service provision.

UNFPA addresses integration of STD/HIV management into FP/MCH as part of its minimum package: 'HIV should be seen as part of reproductive health'. Its Third country programme aims at 'promoting or supporting a holistic reproductive health and family planning service' which envisages the incremental incorporation of RTI management (Including STDs and HIV/AIDS) into existing MCH/FP services (UNFPA/GoG Third Country Programme 1994b:i). In its assessment of the problems to address in the existing service, however, it concentrates on integration of STD/HIV management into family planning services, with no mention of ante-natal care (UNFPA/GoG Third Country Programme 1994:41). USAID also acknowledges that its primary interest and expertise is in family planning (Interview, Halliday 1997). The AIDS component of USAID's current aid programme cites 'improved diagnosis and treatment of STDs' as a major goal (Annex 4. GHANAPA project document, USAID 1994b) but the focus is on information-education within schools, syphilis surveillance among ante-natal attenders and the encouragement of 'all family planning services to provide STD prevention...in the form of counselling and

condom promotion to those considered at high risk', and not for comprehensive screening within MCH services in their entirety (GHANAPA project document, USAID 1994b:59). The newly produced Reproductive Health Policy and Standards document specifies STD/HIV management as part of reproductive health services, but again there are no defined strategies⁹⁷.

Summary

To conclude, the main themes are echoed once again, of vertical structures perpetuated both by donor support and MoH attitudes. It is clear that MCH and NACP both work with particular donors, have different agendas and work within their own structures. There are also biases within the programme structures: AIDS donors focus on AIDS and clinical activities to the detriment of STDs and public health strategies; MCH/FP donors target family planning and moves to integrate STD management into 'MCH' focus primarily on family planning provision. The consequent development of compartmentalised structures and the tendency to the preservation of such programme empires is perpetuated both by donor funding patterns and attitudes of MoH programme heads who not only seek to secure funds for their own programmes but apparently continue to venerate donor funds as the necessary fuel for their engines.

At the end of the first few sections then, the presentation of programme structures and policy development has outlined the structural-management context. The analysis has also indicated the complex interaction of social-behaviour factors (donor pressures and MoH empire-preservation) with the 'hard' context (programme organisation and management structures). From here we turn to an analysis of the wider chorus of voices which attempt to influence policies and programmes and seek to articulate needs closer to the ground.

7.2 THE WIDER ARENA

The preceding analysis has hinted that the main opposing voices to MoH-donor driven policies are from the NGOs, academics and other independent bodies. It is this arena that the regional representatives join to voice district concerns. After a brief consideration of why the regions find it so difficult to project their voice, this section turns to each of the other players and their influence at this level.

⁹⁷ Since the end of the fieldwork period, a clinical service protocol document has been developed, but not yet disseminated (personal communications 1998).

7.2.1 Regional representatives: a cry in the dark...

Individually, regional officials have few opportunities to express themselves. The main fora for articulating common regional concerns is through the Regional Directors' Annual Meeting. Over the years however, an analysis of conference reports indicates very little articulation of the concerns identified in this thesis. A report by a Save the Children Fund spokesperson comments on the lack of articulation of local needs despite a widespread knowledge and concern of them by regional directors (Rose 1995).

A remark by a senior academic may enlighten us here:

'Our national characteristic, which is both endearing and frustrating, is that Ghanaians don't like to make a fuss, therefore we feel restrained [in critiquing things].'

Concepts of power and the unacceptability of criticising one's superiors are explored in more depth in the following chapter. At this stage, the significant point is that it may be easier for local implementation and community concerns to be expressed by individuals who do not speak under the auspices of the Ministry of Health. Since it is the national Ministry people who employ the regional directors, the latter are understandably reluctant to appear to criticise national policy by highlighting difficulties in implementation. Equally they do not want to be seen wanting in their ability to implement, since national respect and promotion may rely on this.

7.2.2 NGOs and Religious Organisations - a thorn in the side?

While both donors and NGOs may work closely with the MoH, NGOs are more involved in implementation than policy development (though they are often present at policy generating workshops and conferences) and their importance in supporting service delivery has been illustrated in preceding chapters. NGOs may be specifically funded by donors, or contracted by the MoH, as well as funding independent projects of their own. Perhaps their most important role at the national level is in providing a voice at meetings and policy seminars which is closer to the problems of implementation and the views of the communities. There are not many NGOs working directly in the health sector; they can be seen, broadly, in two tiers: national and international.

The national bodies (see Appendix 13) can be sub-divided: those that act as implementing agencies for major donor programmes and oversee policy implementation among their member organisations or outlets (like the Planned Parenthood Association of Ghana - PPAG, GSMF); Ghanaian religious organisations (Christian Health Association of Ghana, Christian Council of Ghana, National Catholic Secretariat, Ahamadiya Muslim Mission) and local 'NGOs' (like ISODEC and CENCOSAD) in the more conventional sense working directly with local communities. Most are funded from overseas, often in addition to local membership fees or contributions. Many of these organisations are involved in all sectors, not just in health. Religious groups have a particularly respected voice on ethical and social issues despite limited financial backup, and they are often directly in touch with the needs of local communities.

The NGOs of most concern to the government are the international ones. The main health sector NGOs are SCF, Action Aid, CARE International and World Vision International (see Appendix 13) They tend to focus on particular areas rather than have national support programmes. They work through local administrations or directly with communities and indigenous NGOs, rarely through the central MoH bureaucracy which is the major source of contention between them and the MoH. They are generally more aware of the operational implications of policies than donors or MoH and they may act as implementors of donor funded projects. They tend to be independent and more estranged from MoH, though in the social world of expatriate and bureaucratic cocktail parties, they all meet MoH personalities and retain informal links with major donors.

SCF is the most vocal NGO at a national level and its representatives attend many policy making venues. Although it is often highly critical of what it sees as donor-driven policies, and the hierarchical and vertical structures in the MoH, it is nevertheless a recognised voice in reproductive health issues. Other NGOs tend to go to SCF to gain information on the Ministry's position (Interview, Newson 1996).

The MoH is still undecided about its stance towards the wealth of non-government organisations operating in Ghana's health sector. Currently they are excluded from the most important information sharing forum, the Health Partners Meeting, except on an invitational basis. The main irritation the MoH feels towards these disparate groups, as with the donors who bypass national authority, is that most of them do not keep the government informed on what they are doing: 'they tend to be quite secretive...some of them resent the slightest

attempt to take a closer look at what they are doing' (Interview, Quist Therson 1997). The Director of the NCP is unequivocal on this:

'That's the single, most intractable problem in this country. And we know that a lot of people are taking out all kinds of consultancies and NGOs, some operating from brief-cases and all of that...whether they are in fact doing anything within the framework of national objectives and operations only God knows...It's not good enough. We intend to streamline that if we can as one of the [objectives of NCP].'

Director, NCP 1996

In 1996 the Government of Ghana tried to pass a bill on NGO co-ordination, but there was such an outcry from the NGOs that it had to be dropped (Interview, Quist Therson 1997). The NGOs fear that registration will lead to government interference and activity constraints. While the MoH is quick to deny that their motive is take-over and control, their vision for the operation of NGOs is within carefully defined boundaries (Interview, Tinorgah 1997).

'there is point and a purpose for their being here, and one simply wants to indicate to them what these are and how best together we can sort out the problem in hand. It takes quite a bit of doing, because everybody thrives on their independence.'

Senior Ministry of Finance official, 1997

It is this independence, however, giving NGOs freedom from government bureaucracy, which enables them to have a closer proximity to project implementation without setting up vertical infrastructures and so support more integrated service delivery. But this independence also gives them less influence on national policy decisions. The inverse relationship between knowledge of real problems and the power of decision making (over policy, funding, structures, management and so on) is very clear:

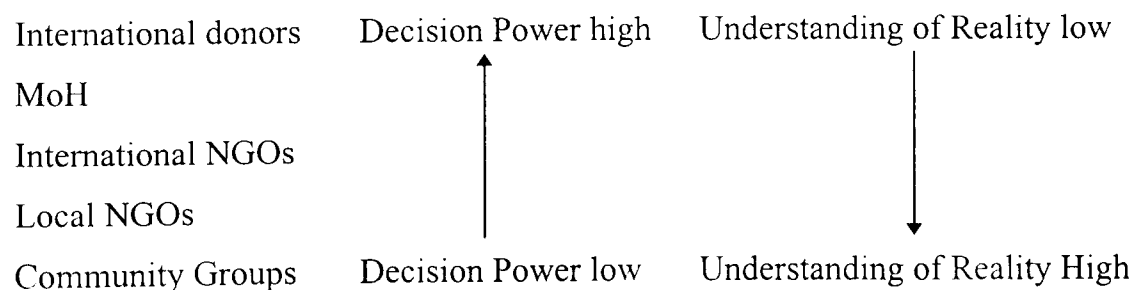

Despite opposition to the proposed NGO bill, there is consensus among NGOs on the need for closer collaboration with government agencies in order to become more involved in the decision making process (Oquaye and Katsriku 1996).

7.2.3 Academic and professional bodies

The academic bodies include the medical and nurse training institutions, universities which carry out related research in public health and the social sciences, and specialised bodies like the Population Impact Project (PIP) carried out by the department of Geography, University of Ghana, Legon (see Appendix 14). Training institutions are dealt with under regional/district level analysis since they are seldom involved in national policy discussions.

As entities, academic institutions do not have serious influence on policy making, but individuals within them may. Recognised experts in a particular field may be invited to speak at seminars, or personally consulted by colleagues within the MoH. The MoH's concern to be seen to retain autonomy over all health related activities causes tension. It wants research to be conducted through its own Health Research Unit, which may carry implications for the sort of reports and results that come out and the positions they take. Lack of dissemination of research initiatives from whatever source is a serious problem.

The Navrongo health research unit is something of an anomaly in that although it is supposed to be a satellite of the central Health Research Unit, it has independent status, largely by virtue of its almost total donor support (Population Council, Rockefeller and others). Its valuable research into community factors influencing uptake of family planning was drawn on in earlier chapters. It could play a vital role in communicating local concerns and issues to national policy makers, since its foreign backing gives it the money, power and status to be listened to. But it is for this reason too that there is tension between the Navrongo research centre and the MoH which regards it as having usurped its status and turned its back on the Ministry for the brighter lights of overseas support and kudos (Interviews, MoH and Navrongo officials 1996-7).

There are various professional bodies in the health sector although none are particularly active or influential (Rakodi 1996). Those most relevant to reproductive health provision are the ones concerned with nursing and midwifery. The Ghana Registered Midwives Association is the most vocal at a national level representing the interests mostly of private midwives. These organisations are regarded as the official voice of practitioners but in reality

the quality of feedback from members is questionable. They do provide guidelines for their members and are responsible for curriculum development, and are therefore involved in any policy changes which might affect the content of these. The most important of these bodies is the Ghana Nurse-Midwives Council which is a very hierarchical institution, upholding conservative views of strict medical practice hierarchies (Interview secretary GNMWC 1997; Interview, President Ghana Registered Nurses Association 1997).

7.2.4 The media and private companies

Media involvement in family planning and AIDS issues is relatively limited and is largely government driven (media analysis 1996-7). Policy developments and statements are usually published in the main government newspaper. Coverage on family planning issues is largely in the form of informative propaganda articles on the problems of population growth and the benefits of family planning for the individual and the greater good of the country. The UNFPA sponsored training of journalists in coverage of population issues sustains this particular stance. AIDS is a popular topic and periodically personal interest stories on the scourges of the disease are run. Information - even whole articles - are often culled from aid-agency literature. Sensationalist journalism usually on clinical stories is also popular, emphasising resource constraints and malpractice incidents. Donor and NGO support for clinical facilities is well covered⁹⁸.

There are curbs on advertising, particularly of AIDS 'cures', STD drugs and contraceptives. The Health Education Unit of the MoH links with press journalists through a 'media network on AIDS' (MENA) and with radio and TV for IE&C activities. It can put in its own adverts or request a TV or radio programme on a health topic at any time, but this must be supported with funds and such activities are not a priority:

'The extent and type of health education for any programme depends entirely on the budget available. Funds are scarce because donors are cutting back - for example for the STD/AIDS programme, HEU gets less than 50% of its former funding levels...HEU can go direct to the donors, but the donors are becoming more activity specific allowing us less flexibility. For example they

⁹⁸ These findings are upheld by a systematic media analysis covering newspapers in Accra which was undertaken by a local consultants group in 1998 (JSA 1998).

will specify funds are for training at district level.'

Senior HEU Official 1996

AIDS/STD jingles and slogans were taken off the air in the second half of 1996 because there was no money (Interview, Ibrahim 1996). The Health Education Unit has tried to get the GBC to give its services free, exhorting the Ministry of Information which refused to respond (Interview, Ibrahim 1996). The other major population/AIDS advertiser is the now private Ghana Social Marketing Foundation (GSMF), heavily influenced and funded by USAID.

Table 7.4 Media Activities

Media Type	Activities/interest in STD/HIV and/or MCH/FP issues	Links/Partners
Press: most is state owned	A few papers have specialist health and population desk. AIDS articles/personal interest stories are common.	UNFPA funds a population course at Ghana Institute of Journalism (GIJ)
MENA (Media Network on AIDS): association of private and government press houses	Produces feature and interest articles. Intended to act as a pressure group for AIDS issues.	MoH (HEU) - meets them twice a year to update and discuss information and priorities. Newspapers/press houses from which the members are drawn - state and private.
Private contractors - Lintas and Apple Pie - contracted by HEU for advertising campaigns	Campaign posters and other IEC materials for MoH STDs and HIV/AIDS awareness campaigns.	MoH (HEU)

At the end of this section we can conclude that, while the national policy arena appears relatively inclusive, it is hard for NGOs, churches and other national bodies to make an impact since they do not have the money (and therefore power) to support their arguments. Private professional bodies and academic institutions provide independent analysis and perspectives; NGOs, who are often the most in tune with reality on the ground, are more involved with implementation. Many bypass government bureaucracy and operate relatively independently. Policy development is therefore essentially a power game between donors and the MoH and their respective agenda-pushing and empire-preservation make it difficult to take other perspectives on board, particularly if they threaten designated priorities.

7.3 SUMMARY

This national analysis has illustrated the arguments mooted at the beginning of the chapter: that the distance of the national policy stage from the realities on the ground is influenced by three main features:

- the absence of district and sub-district level voices, or their representatives, in the national policy making arena,
- the nature of donor powers and support which help to perpetuate vertical thinking and programme structures,
- the hierarchical attitudes and parallel structures within the Ministry of Health which preserve the status-quo.

CHAPTER EIGHT: THE “BIG MEN” SUPREME

‘Sustainability is sustaining donor interest’

Such was the comment made by a leading public health academic on the position of the Ghana Ministry of Health towards donor aid to the health sector. The comment highlights two keys for understanding the national policy arena which were introduced in the preceding chapter: the still powerful presence of international donors and the somewhat fatalistic attitude of the Ministry of Health towards them.

This chapter illustrates in more depth the inter-relationships, the powers and influences of these two central groups of actors. They, and their social-behaviour contexts, explain better than anything else why the national policy making arena is so far removed from the reality on the ground and why this will be so difficult to change. The donor fraternity is considered more closely to assess its influence on policy development and institutional change and analyse evolving donor-MoH relations. The power play within the Ministry of Health is then taken up with discussion of how this is manifested and its implications for the receiving of donor aid and the implementation of reproductive health policies.

8.1 THE DONOR SCENE - ‘HE WHO PAYS THE PIPER...’

Donors are often blamed for neo-colonialist manipulation although in Ghana, donor-MoH relations have become increasingly conciliatory in recent years. Nevertheless, donors continue to wield tremendous power and in the end money still has the ‘loudest voice’. This section first considers the nature of the donor community, clarifying the changing balances of power within it and the implications for reproductive health, then analyses the changing nature of donor-MoH relationships.

8.1.1 Power balances and constraints

There are six or seven key donors in the health sector in Ghana, each with a different way of working. USAID and UNFPA run their own Country Programmes in parallel with (though theoretically complementing) the MoH’s Medium Term Strategy. Many of the other UN agencies, (those that give general health sector aid as opposed to individual projects) have also tailored their programmes to coincide with the MoH’s own 5-year planning strategies. The others (DFID, DANIDA, WHO, World Bank) operate on a more ad hoc basis, though

now most are involved in the new 'Sector Wide Approach' initiative (SWAp) whereby funds will go to central government for the MoH to use as it chooses (but within certain clear parameters and agreed objectives and indicators). There is scepticism in the MoH about donor commitment to the SWAp⁹⁹:

'It will take us the next few years to see how true we are to the statements that we hear, because you hear donors say that we are completely, 100% with you...that this is the only way to go - one programme everybody - but...in the same breath they go and find some part of it they would like to put their stamp on.'

External Aid Co-ordinator, 1997

The World Bank claims to be the 'lead donor' in health (Interview, World Bank 1997). It has certainly been very influential in the re-structuring and resourcing of the MoH since this has been linked to many of its loan conditions (World Bank project documents 1995-7). The perceived heavy handedness of its operations and insensitive emphasis on financial implications and cost-effectiveness have caused considerable resentment, particularly over the imposition of the 'cash and carry' system¹⁰⁰ (Interviews, Quist-Therson 1996, Bamisaye 1997, Tinorgah 1997):

Over the last 2-3 years however, the Bank has 'been trying to play down their picture' (Interview, Tinorgah 1997) and now it is USAID and UNFPA, as previous analysis has shown, who have the more visible presence. Their representatives are present at almost every ministry workshop/seminar/meeting (proceedings and personal observation). USAID has one of the largest regular aid budgets (see Table 7.2 in chapter seven) and also channels funds through 'a whole sluice of co-operative agencies, some you don't even know are USAID' (Interview, Ampomah 1997).

The relationship of the MoH with USAID and UNFPA is fundamentally different, reflecting their different characteristics. The Ghana Population and AIDS programme (GHANAPA) is,

⁹⁹ The SWAp initiative was supposed to be operational in 1998, but a brief return visit in January 1998 indicated that there was considerable uncertainty about the implementation of the programme and the process seems to have stalled.

¹⁰⁰ The cash and carry scheme requires all drugs and equipment used, as well as consultation fees, to be paid for, usually up-front, as a means of cost-recovery. Various user fees have been charged since 1971, but in 1985 they were substantially increased - a decision which was retracted in the wake of fierce opposition and significant declines in health facility utilisation (Waddington and Enimayew 1990). In 1992 the current 'cash and carry' system was introduced as a condition of the IMF's structural adjustment programme - revenues are kept at the facilities and are closely linked to their drug use (GMoH 1992c; Rakodi 1996).

like all bi-lateral negotiations, accountable to the donor government - in this case the US Congress - something USAID is very conscious of (Interview, Halliday 1997). Ghanaian officials are resigned about such constraints of bi-lateral donors (Interview, Odoi-Agyarko 1996; Interview, Quist-Therson 1997; Interview, Tinorgah 1997): 'Of course donors have their particular areas they want to work in. For USAID it is population and AIDS, therefore it will be population and AIDS, no matter what you do...and that's fair enough' (Interview, Odoi-Agyarko 1997). In the end, however, this means that for a major sector-wide programme like GHANAPA (and also remembering the substantial US economic presence in Ghana), if the Ghana Government ultimately needs the funds, they have to concede to US concerns.

By contrast, the Ghana government is a member of the UN, and Ghana currently sits on the Board at UNFPA HQs, giving a greater sense of ownership of UNFPA projects. This is a point which UNFPA seems concerned to stress, emphasising its role merely as 'a catalyst' in the policy making process (Interview, Owusu-Sarfo 1996). MoH consequently regards UNFPA as far more conciliatory, legitimate and neutral than USAID. A senior MoFinance official says 'we *are* UNFPA in a way not possible with the bi-lateral agencies...I can confide things in UNFPA that I can't tell USAID' (Interview, Quist Therson 1996). UN Country representatives have Ambassadorial status and direct access to the Minister. For other donors such access is more difficult.

The explanation for the particular strength of UNFPA compared to other UN agencies in Ghana is partly historical, since population issues have been on the national agenda since independence, and partly personal-political as there are personal links between the current UNFPA Country Director and the President¹⁰¹. Personal links are also obvious where Ghanaian representatives work for bi- and multi-lateral agencies. Both UNFPA and USAID employ Ghanaian nationals as key staff who formerly worked for the MoH. It is impossible to quantify the subtle influences and innuendoes of these kind of relationships, but they must cast a more favourable light on certain donor pressures and recommendations.

Of the other bi-lateral and multi-lateral donors, DFID, DANIDA, and increasingly the Japanese¹⁰², are the most significant, with EU, CIDA and GTZ (the German Technical

¹⁰¹ The UNFPA Country Director, Mr Tesfano, has direct access to the Castle because President Rawlings knows his brother who was involved with the Eritrean Liberation Movement which Ghana has heavily funded (Interview, Bamisaye 1997).

¹⁰² The Japanese are particularly involved in funding research but are beginning to move into the health and reproductive health field. In Ghana they fund the Nguchi Memorial Research Institute which undertakes considerable AIDS research. Internationally, they now give more development aid as a

Agency) involved on a smaller scale, particularly in the STD/AIDS arena, often supporting and working with NGOs. The European donors provide aid under the provisions of the Maastricht treaty framework and have certain links between themselves; DFID and DANIDA, who share a floor in the same building, are especially close. DFID is one of the widest networking donors. They describe their relationship with the MoH as a 'good working relationship...much closer than some of the donors...we have almost daily contact.' The opinion was shared in the MoH itself. The director of NACP regards DFID as 'very open...they usually allow us to lead.' There were close personal links and mutual respect between the former head of Health desk and both the new Minister for Health and the MCH head (Interview, Bamisaye 1997).

Many of the smaller bilateral donors concentrate more on specific programmes/projects or geographical zones, than on national sector wide programmes. DANIDA, GTZ and to some extent CIDA and DFID, tend to bypass the MoH and NCP and deal directly with the districts they are working in. This is a major source of contention between them and the government. The NCP Director is particularly vehement, possibly because such actions reflect the lack of decision making power of NCP in health issues, and so NCP feels a need to affirm its status in aid negotiations:

'Our basic constraint, is the fact that a number of bi-lateral donors are doing things, especially in the districts and so on, without any reference to any-one...DANIDA, GTZ and CIDA, oh yes, those are the culprits. Now, ODA has started doing a bit of that...Very myopic kind of approach.'

Director NCP, 1996

There are legitimate reasons for anger. Aside from the helpless feeling of being kept in the dark about what is happening in your own country, the practice of bypassing official mechanisms has resulted in a number of incidents where funds given to districts could not be accounted for, and the donors concerned (for example UNICEF and USAID) came to central government for an explanation (Interview, WHO 1996; Interview, Smithson 1997).

Reproductive health has a wide and expanding cast of actors, but in Ghana at present, USAID and UNFPA are the donors most evident in the AIDS and reproductive health fields. They both push strong agendas which were illustrated in chapter seven; the maintenance of

percentage of GDP than any European government and are set to become an increasingly significant donor power.

professional closeness with MoH officials plays an unprecedented (and unquantifiable) role in their ability to push policy agendas. The power lines between donor and government may be changing, as the following section illustrates, but the old cliché remains and MoH officials are fond of reminding us that ‘he who pays the piper plays the tune’ (Interviews, senior MoH officials 1996-7).

8.1.2 Donor-MoH relations: shifting sands

Donor-MoH relations have moved a long way from the tensions of the early Rawlings years. Ghana in the early 1980s was a military state where police brutality was commonplace and widespread political and economic turmoil left the country relatively isolated with donor relations considerably strained (Danziger 1991:362; Rimmer 1992; Nugent 1995; personal communications 1995-8). Since Rawling’s ‘democratic’ election as a civilian leader in 1992, antipathies have mellowed and the Ghana Government has begun to take the dominant role, expressing concern and resentment at donor activities and operations (Hiscock 1995; personal communications 1995-8). Although there are still tensions between donor and the MoH and NCP, especially where donors by-pass government administrative procedures, both senior civil servants in the MoH as well as donor representatives generally agree that donor-MoH relations have vastly improved (Interviews, Tinorgah 1996-7, USAID 1996, DFID 1996-7).

‘There has been resentment at one time or another about the roles some donors have been playing, particularly the World Bank’s role...but where we are now, we actually have a lot of donors on board with us...’
External Aid Co-ordinator, 1997

This may partly be because international paradigms for donor support are changing, to emphasise indigenous partnership and lead-taking and increased flexibility in donor funding through the SWAp¹⁰³ approach. The timeframe also corresponds to the restructuring of PPME with the establishment of the External Aid Unit (in 1992) and a general effort by senior MoH officials to fight for more control in the aid process. The External Aid Co-ordinator describes former Health Partners’ Meetings (revealingly these were then called Health Donors’ meeting), held at the World Bank as a forum for ‘MoH bashing’ (Interview, Tinorgah 1996). Now the process seems to be more participatory:

¹⁰³ Sector Wide Aid Programmes. Otherwise known as the ‘common basket’ whereby donors pool resources for a particular sector which are then treated as government funds and are not further demarcated (though there are certain caveats attached).

To move from those days when a lot of statements you hear are about how the Ministry lacks capacity and can't do this and cannot be trusted, to when we are talking about giving the Ministry more direct control of more and more resources I think is a good move.

External Aid Co-ordinator 1997

The MoH has shown its authority more in recent years, indicating an increasing confidence noted also by Hiscock (1995) in her article on donor activities in Ghana. The External Aid Co-ordinator remarks:

There are limits, someone comes in who wants to work in reproductive health and not go into equipment...[but] we've reached where we can say we don't want any more support for the NACP because when it comes to developing their materials for training, we've done that already.

External Aid Co-ordinator, 1997

The World Bank has been made aware of MoH displeasure at some of its actions (Interview, Tinorgah 1997); the MoH bypassed the WHO country office and went straight to Geneva for sponsorship of the First National Consultative Meeting on Safe Motherhood (Interview, WHO 1996). Later the MCH unit threw out a WHO proposal for a seminar on safe motherhood saying it wasn't needed:

'There was a time about 2 years ago when WHO wanted us to organise a conference on Safe Motherhood. I told them no, that we'd passed that stage, they could take it to another country. We have had our conference, identified our problems, we know our situation and we're not going back as if we don't know...I think now it's much better, we can direct the donors.'

Head MCH Unit, 1996

Some donors still have powerful influence though, and now drive their agendas in more subtle ways. MCH does not, for example, have the same authority as that cited with WHO (which offers technical support rather than significant funding) when it comes to dealing with USAID (as in the development of the Reproductive Health policy document), whose specific conditions are tied to the release of the whole Programme's funds.

The involvement of two dominant donors (USAID and UNFPA) in the population and AIDS field, can create considerable tensions within the MoH. Despite the closeness of the MoH to UNFPA relative to USAID, a colleague of the MCH Unit Head says she is pulled 'between a wall and a pillar' (Interview, Bamisaye 1997). DFID believes MCH (and MoH) has solicited them on occasion in 'an attempt to keep UNFPA and USAID forces in check' (Interview, Bamisaye 1997). DFID has favoured partnership with UNFPA on several occasions, for example, all UNFPA's contraceptive supplies to Ghana are funded by DFID. The NCP Director for Reproductive Health recognises the importance of co-ordinating donor inputs remarking, 'you have to create sanity' by ensuring that donor roles are 'complementary'. Co-ordination of donor inputs may be the most important role the MoH and Ghana government can play. A number of attitudes persist among officials which suggest that there is not the political will ever to see the country free from donors and so from the inevitable manipulation which is tied to external monetary support.

While the higher echelons of the MoH still express frustration at continued donor control: 'Donors don't come here with leeway...they give money for specific programmes' (Interview, NACP Director 1997), there is, among the same people, a fatalistic acceptance of their dependency on them:

'I think we make sustainability arguments as if Ghana were self-sufficient, we're not self sufficient, so it's not an option that we are going to say to donors "thank you we don't want any more support we are self sufficient" it's not an option for us. So sustainability has to be seen in the context of how well our systems can absorb the resources and use them and give donors the confidence to continue to sustain their donations into the country rather than to cut them.'

External Aid Co-ordinator, PPME, 1997

'When you are poor everyone feeds you with bile...The NCP is like a beggar sitting by the roadside. A guy in a BMW pulls up and throws 3000 cedis. A guy in a landrover throws 2000 cedis. We pick it, we have no choice.'

Director, Reproductive Health Division, NCP, 1997

The problem is not so much with the acceptance of need (which is real), but the apathy it can create and the reliance on donor support to drive initiatives:

'There are things that can be done without money, but they won't be done, because people are thinking that if there's a possibility of getting money for it, they shouldn't do without it.'

Director, UNAIDS Country Office, 1997

'There are all kinds of people in this country who are prepared to take all your money at any time [and not account for it]'

Director NCP, 1996

'...the MoH is helpless because it likes vehicles and isn't going to say "no" if they are offered.'

Director, School of Public Health, 1996

Academics at the University of Ghana have harsh words for the MoH, condemning it as hierarchical, too willing to accept donor aid and generally out of touch with reality on the ground. One senior academic is highly critical too of international aid which he regards as 'undermining development' by 'not allowing us to fail'¹⁰⁴, thereby creating a situation where 'sustainability' *has* to be defined as 'sustaining donor interest'.

At the end of this section it is clear that donors still wield great influence, largely because of their financial power. Nevertheless, a far more conciliatory policy environment has developed in recent years, giving the MoH much more input in steering donor support. Donor funding paradigms are also changing gradually with the potential to become more flexible. This notwithstanding, there are attitudes within the MoH that help to perpetuate a status quo in which monetary issues still dictate programme structures that may be in conflict with integrated service implementation. We turn now to a closer consideration of the MoH, and concepts of power, money and political hierarchies, exploring the nature of national level social-behaviour contexts to gain an understanding of why particular attitudes exist.

¹⁰⁴ This has echoes of writings of Kabral (an eminent Ghanaian thinker) on colonialist-perpetuated subjugation of African nations. To paraphrase: 'we have been taken away from the possibility of making our own history'. That the attitude is still held among thinkers is important, because it points to the fact that African political and economic identity needs to be confronted together by African and Western states if the donor-receiver conundrum is ever to be resolved.

8.2 HIERARCHY AND POLITICS IN THE MINISTRY OF HEALTH: IMPLICATIONS FOR REPRODUCTIVE HEALTH POLICY

'When people get authority they think they can do it all themselves...'
Interview, Director Medical Services, 1996

*'Lesser officials tend to pass even mundane decisions upwards for fear of
being seen to undermine the status of the 'big man' at the top.'*
Price in Nugent 1995:52

Preceding sections have illustrated the relatively conciliatory environment of donor-MoH relations and how, despite this, donors continue to influence programme structures and policies. The quotes above illustrate facets of the key theme of this section, one which we have seen echoed at all levels of society: the nature of power and its impact on policy at all levels of the process. This section charts the internal power hierarchies in the MoH which help to maintain the relational and structural status-quo. First the differences and tensions between key staff are discussed and the impact of these on the nature and operation of the different departments and units. This illustrates the way 'hard', structural/systems contextual factors are influenced by less tangible social-behaviour elements. Second, a closer consideration is made of the concepts of status and power - the 'soft', more symbolic elements of context.

The Ministry of Health is usually a weak administration within the national civil service of developing countries but in Ghana we have seen it to be relatively strong, attracting considerable donor funding although, unlike education, health is not a constitutional right for Ghanaians (Constitution of the Republic of Ghana 1992). The MoH won respect from donors and government officials (Interview, Smithson 1997; Interviews 1996-7) in the early 1990s by taking the lead in the decentralisation of its civil service¹⁰⁵. It was one of the first Ministries to decentralise its administration and implementation strategies, as indicated in its Medium Term Strategy for Health and 5 Year Programme of Work. The decentralisation and the development of the Ghana Health Service should be seen in the context of broader government changes, undertaken as part of the World Bank/IMF driven re-structuring of the civil service and government administrative structures (Larbi 1995). In direct health policy issues however, the MoH is a powerful negotiator in its own right with competent leaders who are recognised and respected by the donor community:

¹⁰⁵ See Chapter six and Appendix 7 for detail on decentralisation.

'The leadership in Ghana is very knowledgeable and highly educated'
[DANIDA]

'The MoH has some very competent and very ambitious people...' [EU]

'There are many strong people in the MoH' [DFID]

Such comments also imply the potential for internal conflicts - to an analysis of which we now turn.

8.2.1 Structural flux: the powers within

'There's an interesting change going on in the Ministry of Health. Nobody knows what is going on.'
Interview, CARE 1996

Since the 1992 Constitution, Ghana's MoH has gone through several periods of internal restructuring (Government of Ghana MoH-TCRD, 1993). It is still in flux with various proposals being considered including the abolition of all programmes in favour of a systems approach¹⁰⁶ leading to the remark by a senior NGO director quoted above. The structure of MoH as at September 1997 is shown below.

¹⁰⁶ This was an idea put forward by the then Acting Director of Medical Services, and is vehemently opposed by the head of the MCH unit which benefits from the current programmes approach (Interview, Odoi-Agyarko 1997).

Figure 8.1

Organogram of Ghana Ministry of Health as at 1997

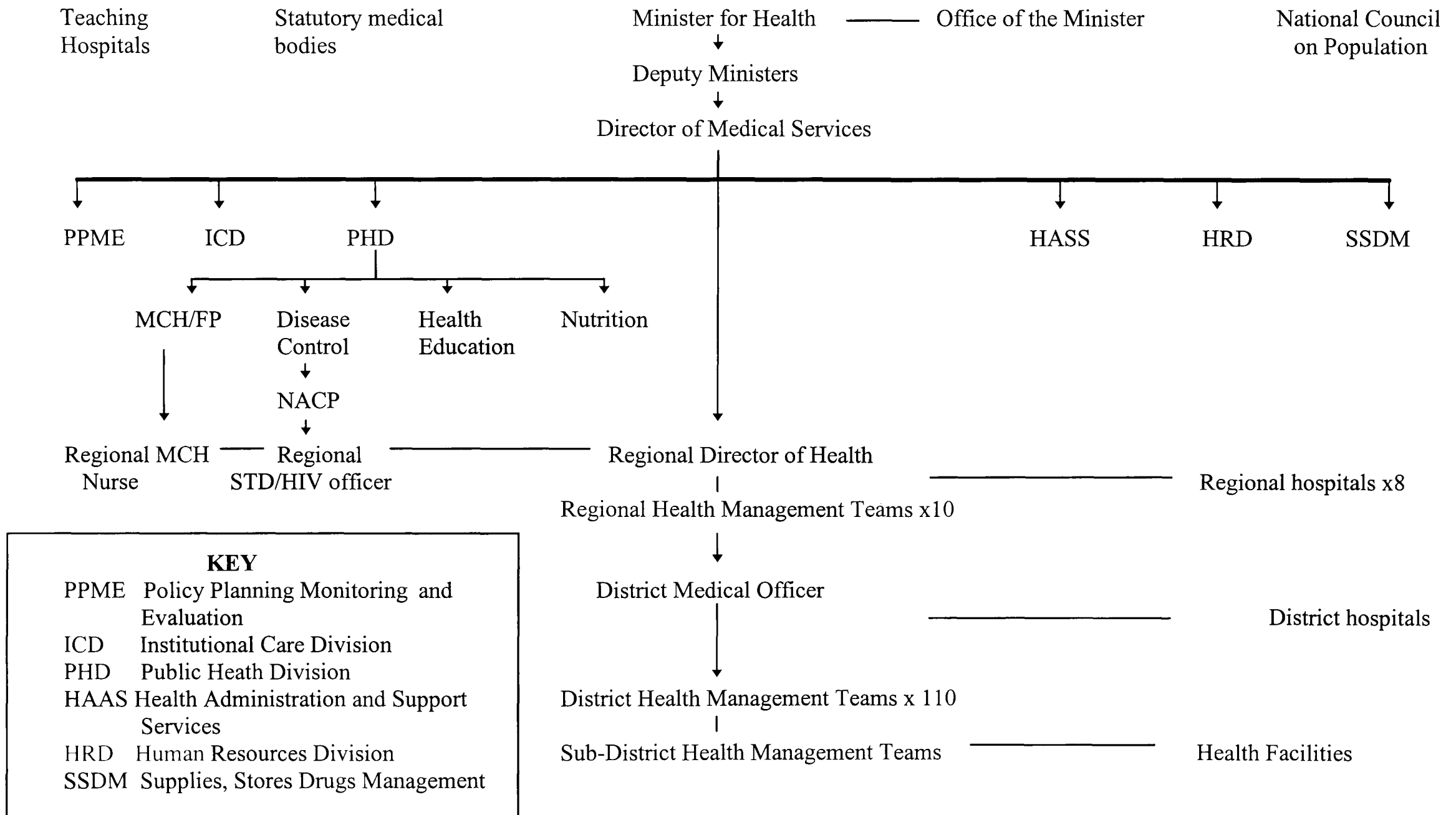

The relative power of the different divisions involved in changes are influenced by the personalities at their helm. Although all Divisions are supposed to be the same rank, the Policy Planning Monitoring and Evaluation Unit (PPME) is generally acknowledged as the most powerful. All budgets and financial decisions pass through PPME before going to Ministry of Finance. It can have direct influence over any programme within the MoH in the way described in the quote from Price at the entry to this section:

'Lesser officials tend to pass even mundane decisions upwards for fear of being seen to undermine the status of the 'big man' at the top.'

Price in Nugent 1995:52

The power of PPME is perceived to have developed largely because of its Director who is regarded by many to be the strongest single personality in the Ministry who personally oversees (and influences) every major decision (Personal observations 1996-7; Interviews 1996-7); his authority is discussed further in section 8.2.2 below.

In the original (1991-2) donor influenced restructuring proposals, External Aid was to be a division by itself, but the government was adamant 'that external aid has to be driven by the policy priorities of the Ministry' and it was placed within PPME (Interview, Tinorgah 1997). This gave the MoH the opportunity for the first time to have an overview of donor funding and activities which enables co-ordination of these in a way not previously possible. The External Aid Co-ordinator described how the changes gave the MoH increasing control over how funds could be used. So, for example, the development, distribution and training for the STD treatment guidelines between 1994-1996 harnessed funds from different donors for different parts of the project, since no one donor was prepared to fund the whole enterprise. He admitted though, that vestiges of pre-restructuring groupings remain which impede such collaborative use of funding because different programmes 'especially MCH and AIDS...have their own groups of donors' and still ringfence funding for their own programmes (Interview, Tinorgah 1997).

The influence of dictatorial hierarchies on structures and decisions is clearly evident in a number of position shifts among key personnel during the research period. Dr Ahmed who was head of Disease Control Unit, formerly under the Technical Co-ordination, Research and Development Division (TCRD) (since restructured), now under the Public Health Division (PHD), was appointed Director of PHD. This caused resentment among peers previously on the same hierarchical level as him who were reluctant to regard him as a

superior with authority over them. Another senior official remarks ‘people who had power before won’t give up their authority’ (Interview, Otoo 1996). Professional jealousy may have occasioned the removal of Dr Ahmed¹⁰⁷ from the PHD Directorate in 1997. to the minor headship of the Onchocerciasis Unit which, because of his former status, has been promoted to become a separate programme on the same level as MCH and Disease Control (under which it was originally placed). The official explanation for this is that the Minister deemed onchocerciasis a sufficiently important health problem to be given programme status and a high-standing director! (Interview, Otoo 1997). In Ahmed’s place, another former head of Disease Control Unit, Dr. Bughri, has been appointed. An NCP official voiced the frustrations felt by many:

‘The problem with this country is that people won’t get things done - there’s too much petty squabbling...protecting of empires and so on.’
Senior NCP Official 1997

Table 8.1 below indicates the position changes which have taken place within the 12 months of field research (1996-7) - a year described by the former Director of Medical Services as one of ‘not much change’.

This constant shuffling of positions means there can be little continuity in programmes which makes it very difficult for any but the most influential voices to make their concerns heard and acted upon with any lasting commitment. Administrative posts within the new Ghana Health Service will be for a 5-year term, perhaps in recognition of this fluidity. Nevertheless, as with Ghana’s politicians, notably the ‘big six’¹⁰⁸, the resilience of its civil servants keeps them resurfacing - at different points, but in the same pond, creating a certain continuity at a more general level. Similarly the names of currently prominent MoH officials are likely to surface and re-surface across the health sector spectrum allowing the same minds to mull over recurrent problems.

¹⁰⁷ There also reports that the First Lady, Nana Rawlings, was offended in some way and consequently requested Ahmed’s removal. As the scope of the present research could not cover presidential politics in depth, little ‘evidence’ of the power of the President’s wife can be presented, but there is consensus among researchers and donors that Nana Rawlings has tremendous power over her husband and in ministerial affairs.

¹⁰⁸ The ‘big six’ were politicians who dominated the political scene in the late 1940s with the United Gold Coast Convention (UGCC) and who returned to power under various subsequent regimes. They were: J.B. Danquah, William Ofori-Atta, Akuffo Addo, Ako Adjei, Obetsebi Lampety and Kwame Nkrumah.

Table 8.1 Personnel Changes in Key MoH Posts 1996 - 1998

MoH Position	Personnel changes during research period
Minister for Health	Dr Adamafo until June 1996 Col Obimpeh June 1996 - August 1996 Dr Brookman Amisah August 1996 - August 1998 Mr Numuah-Donkor August 1998 to date
Director Medical Services	Dr Otoo 1996 Dr Asamoah Baah (Atg) June 1997 to date
Director Public Health Division	Dr Ahmed 1996 Dr Bughri 1997 to date
Director Disease Control Unit	Dr Ahmed 1996 Dr Bughri 1996- April 1997 Dr Saggrey May 1997 to date
Director NACP	Dr Asamoah-Odei 1996-c.May 1997 Dr Ahadzjie May 1997 - Dec 1997
Director MCH Unit	Dr Odoi-Agyarko 1995 to date

For some though, the recurrence of actors represents simply the continuation of current power groupings under different names, perpetuating limited delegation of power and externally influenced policy directives:

'Internal position changes are political; new figures merely mean old wine in new bottles'

Senior Navrongo health research centre official, 1997

In the reproductive health arena, the previous chapter highlighted the tensions and confusions concerning the responsibility for and co-ordination of the different components. In recent months the strength and confidence of the MCH unit seems to have grown. According to the then head of DFID's health desk, this is because its head 'has backing support which can only come from one source - the Minister.' (Interview, Bamisaye 1997)

The Minister for Health during the research period, Dr Brookman-Amisah, was appointed in 1996 after the removal of the former Minister because of a scandal over the misuse of hospital rehabilitation funds to secure votes in the 1996 general elections. The new appointment was a positive move for reproductive health. The former Minister is reputed to have been 'equivocal' towards reproductive health (Interview, Bamisaye 1997), but the new Minister, a woman and a Medical Doctor, is very pro-reproductive health and appears keen to support her programme heads. Her interest was manifest in her participation at national level seminars, such as the 1996 'National Summit on Adolescent Reproductive Health' at which

she gave a personal and committed address for which delegates were full of praise (conference proceedings and personal observation 1996). Her ability to bring together MoH programme heads to co-operate effectively for the co-ordination of reproductive health programmes however, depends on her ability to harness the several dominant personalities within it, not all of whom share her enthusiasm for reproductive health. This is no easy task since the power of hierarchy illustrated in the next section serves to entrench positions and limit discussion. In August 1998 Dr Brookman-Amisshah was given an ambassadorial appointment and is replaced by one of the deputy ministers, Mr Nuamah-Donkor who is himself replaced by a former Director of Medical Services, Dr Adibo (*Daily Graphic*, August 7, 1998). The new Minister's position on reproductive health is unknown. The lack of continuity of staff is particularly significant for programmes like reproductive health which span so many different units and need to be able to develop good links between the relevant units and their heads if real understanding of implementation issues is to be gleaned and acted upon.

8.2.2 'Big men - small boys' and the hierarchy of status

'Naturally at staff meetings, nobody speaks till the big man does, his contribution at once becoming the consensus.' Nugent 1996:1

'It [is] almost to be expected that those who rule would behave with the arrogance of traditional "big men"' Nugent 1996:21

Chapter three indicated how hierarchy affected the willingness of nurses to take decisions: nurses refer and doctors expect that. Chapters four and five revealed how the idea of 'status' is important in Ghanaian society, influencing health worker-client relations and health-seeking behaviours; chapter six explored how concepts of power are closely associated with money. These ideas also help to explain why national status-quos are perpetuated. National power-relations are influenced by complex social hierarchies which pervade every level of Ghanaian society, by individual personalities who claim 'big men' status through education, monetary control or family ties, and by concepts of money. The following discussion briefly considers each of these.

The quotes above testify to the importance afforded a 'big man'. A number of interactions among MoH officials illustrate the often detrimental influences of social hierarchies on policy and decision-making. An anecdote from a senior DFID representative shows how the head of the MCH unit felt constrained under one of the former Public Health Division Directors. During a meeting with the then Director of Public Health a question was asked on whether community based family planning agents could initiate oral contraceptive cycles:

'[The director] said "no, they can't". [The Head of MCH] kept quiet though in the MCH policy it states that they can. I queried this with her afterwards and she answered "yes, that's right, but I couldn't contradict my Director."'

DFID Health representative, 1997

The importance of this anecdote lies in its illustration of the authority that must be accorded ones' superior, even if they are wrong, and the superiority - even arrogance - which 'big men' are expected to show. The quotes from Nugent, above, also show this (Nugent 1995). Nugent's book *'Big-men, small-boys and politics in Ghana'*, contains a lucid analysis, with countless examples, of what constitutes a 'big man' and how these claims are legitimised.

Individuals can gain 'big man' status in a variety of ways. Traditionally status was socially determined by family wealth and position. The emergence of a *nouveau riche* among the southern cocoa-growing areas during the colonialist era created wealth among families who did not necessarily hold previous social standing¹⁰⁹. Wealth from cocoa aided the development of an educated elite, often the product of overseas education or the highly respected mission schools of the coastal area. By the 1950s a generation of doctors, lawyers and other professionals demanded social standing in their own right, independent of wealth, though this was usually present also. The names of certain highly educated dynasties (like Casley Hayford and de Graft Johnson) are still emblems of elite status. These twin assets of wealth and learning still provide, as in the world over, the legitimate claims to authority and power.

At the national level the association between private accumulation of wealth and the structures of state is particularly important. In pre-colonialist structures the accumulation of wealth depended greatly on access to state resources and privileges (Nugent 1995). This dyadic relationship continued through colonialist times when cocoa wealth provided opportunities to buy into local power structures. After independence, political connections brought an expansion of wealth and consolidation of power for the ruling elites of the first and second republics (see Rathbone 1973; McCaskie 1986; Nugent 1995). Individuals can secure significant power through a combination of university and postgraduate training (preferably overseas since this carries considerable prestige) and the ability to manoeuvre

¹⁰⁹ For authoritative key texts on Ghanaian history and the social, political and economic developments of the country over the last century, see Rathbone 1973, 1983; Wilks 1975, 1993; McCaskie 1983, 1986; Rothchild 1991 and Nugent 1995.

into a position of control over financial resources. The power of an individual personality upheld through a system of hierarchy in state bureaucracy can, as anywhere, have a profound impact on policy decisions and activities. The most obvious example of the power of an individual and the effect this has on a system like the MoH, is the sometime Acting Director of Medical Services and former Director of PPME, a man with a prestigious education record, significant professional contacts and undisputed ability.

A protégé of WHO funding, this figure is generally acknowledged as the most powerful man within the Ministry - 'The lion behind the throne' (Interview, Williams 1996). While undoubtedly very able and clearly capable of controlling things at the apex¹¹⁰, he is the archetypal 'big man', 'he's not a manager or a delegater...everything has to go through him', whether a minor internal memo or a major policy initiative and he can display great arrogance (expected of a 'big man') in his dealings with donors and officials (personal observation and Interviews 1996-7). The strong hierarchy system enables him to support a programme and harness donor funding for it¹¹¹, or jeopardise it unless it already has substantial external backing, and can paralyse a system which requires co-operation and collaboration to fulfil integrated service provision. A colleague comments 'one of the reasons for his power is that a lot of the policy issues are discussed out of the MoH' - directly with donor agencies (Interview, MoH official 1997). Reproductive health is not one of the programmes which enjoys his support; he has been openly hostile to emphasis on it, seeing it as 'just a fad, as immunisation was in the eighties, and all the donors want to put money there' (Interview, Bamisaye 1997). The strength of donor support for various components of reproductive health has, in this instance, muted his power.

The then Director of Medical Services (DMS) notes how the power problem can disrupt management and communication flows:

'It's part of a management chain problem. When people get authority in their hands, they think they can do it all themselves...

There was a direct line from the Division [the 6 Directorates] straight to the Minister, bypassing the DMS...it was causing problems so we've taken action

¹¹⁰ The former head of DFID's Health desk describes him as 'probably the most brilliant thinker I've ever worked with'.

¹¹¹ The 'big-man' maintains close personal links with the health sector donors. He has his own vision of where the MoH is going and he knows the power the donors wield, the resources and their agendas, and seeks to harness these in support of his own ideas.

to create the correct lines of reporting so they all come through the DMS.'
Director of Medical Services, 1996

These comments are a veiled reference to the PPME unit, which the current Director headed at the time, and were made more explicit at a later interview which also explained the 'action' taken:

'There was an anomaly in the system. There was a lot of work in PPME, so top executive jobs were hijacked by PPME - lots of things were happening that the DMS didn't know about. They did their own thing, there was no information flow between PPME and the DMS, the DMS was shut out. PPME had a direct link with the Minister. Now the DMS [acting], is also the Director of PPME so the position is temporarily solved....'

Director of Medical Services 1997

The last of the three influences on national power-relations cited at the opening of this section, is concepts of money. This has already been covered in chapters six and seven and so is only briefly mentioned here. We have seen that the Public Health Division, with responsibility for STD/HIV and for MCH/FP programmes, has an unusually strong position and attracts considerable donor funds. The reasons for MCH, like others, wanting to preserve its donor support are linked to monetary power concepts, as an MoH official explains:

'it's so political because holding money gives you power...there is resentment of MCH heads and reps because they have so much power.'
MoH Official 1997.

It is understandable therefore that MCH vehemently opposed a 1997 proposal by the then director of PPME (the budget division) to abolish the programme structures in favour of a cross-section systems approach - 'it can't work...it's a silly way of looking at things' (Interview, Odoi-Agyarko 1996). That this particular altercation should involve the former director of PPME, and that the systems approach is currently being discussed at WHO HQs, is no coincidence¹¹².

These social and professional hierarchies and the association of money with power. show

¹¹² The then PPME Director, was a protégé of WHO sponsorship and in August 1998 had joined WHO staff in Geneva (personal communication 1998).

how agendas may be pushed and decisions taken according to authority and monetary concerns rather than real needs. This has particularly important implications for reproductive health where donor agendas are strong and supported by promises of lucrative funding.

8.3 SUMMARY

Applause rang out to the Minister's opening address at the policy seminar on Adolescent Reproductive Health at Ghana's premier hotel in Accra. The delegates - representatives from donors, NGOs, professional bodies and academics - filed out of the air-conditioned conference room to coffee and pastries served in the gardens to discuss the merits, constraints and potentialities of the various avenues of reproductive health policy.

Personal Observations, adolescent reproductive health policy making seminar, May 1996, Accra

We have come a far cry from the dusty, curtain-screened consulting room at Binaba Health centre where the cows drink from the mud-pool at the bore hole just outside. The national level analysis of this chapter provides a deeper understanding of the themes introduced in the preceding chapter:

- The two major forces at national level, the dynamic personalities within the MoH and NCP and powerful donor agendas, each have vested interests in maintaining the status quo.
- The power of the MoH 'Big Men' is balanced, and often swayed, by the (monetary) influences of external agencies and despite assertive and capable minds in the MoH and increasing autonomy of decision making, there is still an ideological and material dependency on donor funds.
- The net result creates a policy making arena responsive to monetary and power dictates rather than serious consideration of local voices.

The cycle of analysis is complete and taking all the chapters thus far, it is clear that a complex range of factors mediates the course of policy from its development at the national level, to its implementation at the sub-district. These factors, at macro and micro levels, lie on a 'contextual continuum' which is taken up in the final chapter where the implications are considered.

CHAPTER NINE EYES FOR THE FUTURE

*'The real voyage of discovery consists not in seeking new landscapes
but in having new eyes.'*
Marcel Proust

We have come full circle, from the international ideologies of reproductive health and the policies developed at national level, through attempts to implement them in the neglected, under-resourced, under-utilised health services of the Upper East region and back to the air-conditioned conference rooms in Accra where policy makers gather with international civil servants and bureaucrats to decide on the delivery of reproductive health services to the nation. The gulf between the actuality of the delivery and use of reproductive health services and the policies drawn up by officialdom, is the result of profoundly complex policy processes which this thesis has sought to illustrate and understand.

Policy research and the issues affecting policy are not new, but, as Proust advocates, this thesis has tried to look at some of these problems with new eyes. By documenting the complexities of reproductive health policies at all levels, this research has shown the influence of a range of contextual factors highlighting the fundamental impact of social-behaviour factors which span the spectrum of the entire policy process. The research employed a basic model (based on four key elements: policy process, content, context and actors) applied at multiple levels, which was iteratively refocused to keep 'context' at the centre of analysis. This in-depth, multi-level approach, investigated the policy process at all levels of the health service and added a further dimension by incorporating the attitudes and experiences of communities. This allowed a synthesis of macro and micro dimensions using 'ethnographic' detail to understand macro processes, facilitating a better understanding of the whole policy cycle.

To illustrate the central importance of contextual issues for understanding and analysing policy a simple model was developed (below). The stages of the policy process form the outer circle with the actors placed in the centre. The actors' actions and decisions at each stage of the policy process (represented by the arrows) are mediated by the contextual environment which surrounds them.

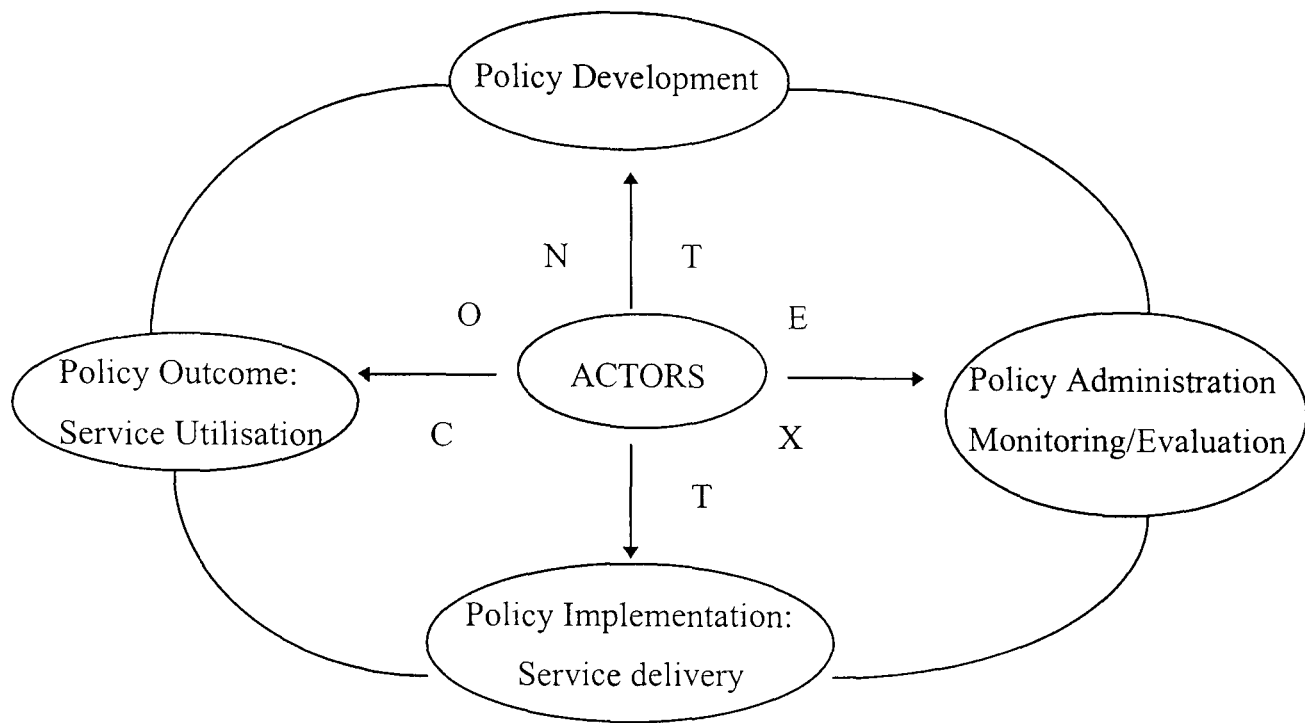

Figure 9.1 Model For Understanding Influences on the Policy Process

Three clusters of ‘contextual’ factors were identified, although these should not be considered definitive or mutually exclusive. They are summarised in Table 9.1 below. The myriad specific clinical-technical (I) and systems-management (II) factors are ‘hard’, tangible elements which can mitigate against proper implementation and integrated systems functioning. The social-behaviour (III) factors are ‘soft’, less palpable elements and mediate relations between actors at every level influencing their actions and decisions.

Table 9.1 Contextual Factors influencing STD/HIV and MCH/FP policies in Ghana

Level ----- Contextual Factors	Policy Outcome: Community utilisation	Policy Implementation: Service Delivery	Policy Administration	Policy Development
Clinical - technical	*Poor services	*Drugs not available in MCH/FP units 2nd/3rd cycle drugs limited *Lack STD management training *Lack referral laboratory facilities	* Poor reporting on clinical/ technical issues * Untimely and inflexible money flows	* Plurality of advice and advisors * Conflicting advice from different parties
Systems - Management	*Health service options limited	*Lack guideline dissemination and follow-up of training *Costliness of drugs, reagents, equipment and transport *Inconsistent recording STDs *Poor data generation and management *Inadequate funding for IEC/ public health activities *Few initiatives to reach men	*Upper East is impoverished *Few disposable resources *Inflexible and untimely funding impedes programme implementation and service delivery *Roles and responsibilities of regions are ambiguous - currently perpetuate vertical structures and power hierarchies	*Vertical funding and reporting mechanisms reinforce compartmentalised thinking and service delivery *Absence of mechanisms to allow district and sub-district voices to be heard and taken up

Table 9.1 continued

Contextual Factors influencing STD/HIV and MCH/FP policies in Ghana

Level ----- Contextual Factors	Policy Outcome: Community utilisation	Policy Implementation: Service Delivery	Policy Administration	Policy Development
<p>Social - behaviour</p>	<ul style="list-style-type: none"> *Services perceived as expensive and poor quality *Wider health priorities (food, water) not STD/HIV * Victim blaming of STDs (especially women) *Female identity through childbirth * FP, STD/HIV and sexuality are taboo topics *Condoms culturally unacceptable *High risk behaviour: male sexual networking and dry sex 	<ul style="list-style-type: none"> *Treatment hierarchies (nurses not allowed to treat STDs - refer) *Priority to clinical rather than public health activities *STDs inconsistently/incorrectly recorded because taboo * Absentee-ism * Competing priorities (Family and social obligations) 	<ul style="list-style-type: none"> *Hierarchical attitudes *Concepts of power revolve around money and lead to: *Neglect of management, monitoring-evaluation, surveillance and collaboration/partnerships development * Status hierarchies result in a fear of questioning authority or being seen to criticise procedures and decisions. 	<ul style="list-style-type: none"> *Hierarchies of power leads to empire preservation, and perpetuation of status quo (dependency on donor aid which gives money, prestige and therefore power to national elites) *Donors highly influential - money talks - perpetuating vertical support

During the course of the research, it became clear that it is the social-behaviour cluster, in particular the manifestations and experiences of power, which has a fundamental influence on the course of reproductive health policies in Ghana. If the different cluster types are added to the model, social-behaviour factors form the circle of primary influence around the actors influencing each stage; the other clusters are important at different stages.

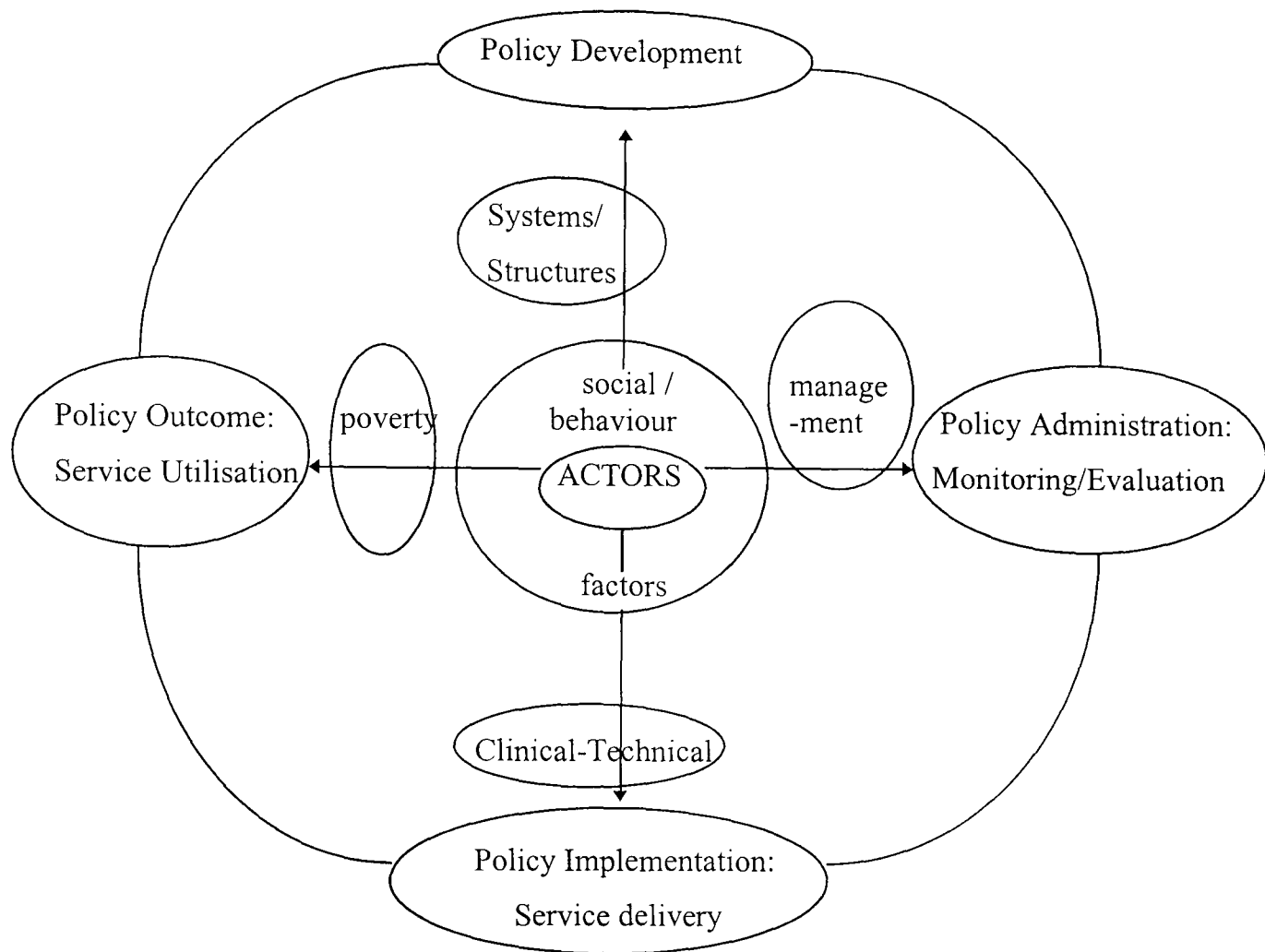

Figure 9.2 Contextual Factors Influencing the Policy Process

The nature and influence of social-behaviour factors have rarely been analysed in relation to policy at multiple levels, in particular notions of power and how they influence policy at every stage has often been neglected in health policy research. The interpretations of power and social-behaviour factors are inevitably subjective and a definition of ‘power’ has long eluded analysts and researchers. This thesis is one contribution to documenting and analysing some of the manifestations and effects of power and social-behaviour factors which are so often neglected, but which are profoundly important to the study of policy. This research has revealed a large variety of types and forms of power which interface with each other and interact with other factors in a complex way.

Three key points can be highlighted:

- There are a myriad of complex clinical, technical and management issues around STDs and reproductive health, many of which have yet to be clarified. Where policy content is ambiguous or uncertain, implementation is much more difficult.
- The implementation process is highly complex because it is mediated by notions of power, hierarchy and status at all levels: from officials at national, regional and district levels, to providers at the service delivery level and individuals at the family/household level.
- These notions of power partly explain why it is so difficult for policy makers at national (and even regional) levels to take into consideration the distant voices of the community and locally-operating organisations (like NGOs and religious groups).

These points are taken up in the following sections which summarise first, the influence at each level of the key contextual factors illustrated in the table, showing why the notions of power and status are of central importance in explaining the development and implementation of current reproductive health policies in Ghana. Secondly, a brief consideration is made of the ways in which the policy-practice gap might be bridged to link macro and micro levels and allow community voices to be heard.

9.1 POLICY SPECIFICS AND THE PERVASIVENESS OF POWER

9.1.1 Service delivery level

The service delivery level analysis of chapters three and four indicate that current services in the Upper East are unable to offer sufficient resources, privacy or counselling to effectively manage STDs and reproductive health issues. The difficulties of implementing STD/HIV management policies in MCH/FP services span the three areas of factors indicated in Table 9.1. The clinical/technical and systems/management factors indicate how complex issues of policy content are. Analysis of the social-behaviour factors illustrates the complexities of notions of power and authority and their influence on policy development and implementation.

Clinical-Technical and Management Issues

A range of problems that beset the clinical management of STDs have been highlighted by this research. High drug costs and poor availability of the most effective STD drugs; no drugs available within MCH/FP units; lack of quality-control of training initiatives, no follow-up and limited dissemination of syndromic guidelines below the regional level; poor referral and laboratory facilities; limited surveillance capacities - all these impede policy implementation. Utilisation of health services in the region is generally low, probably reflecting the deficiencies in quality. Services are perceived to be expensive and far away from most rural communities, with staff not necessarily available. The improvement of clinical services will require a policy focus on drug pricing (and procurement which might reduce costs), transport mechanisms, standardisation and follow-up of training and the development of surveillance, data management and regional laboratory capacities to monitor disease prevalence. Given the relatively low prevalence of STDs and HIV in the Upper East, however, and the presence of other immediate health priorities, clinical STD interventions should be targeted in high-prevalence areas and high-risk groups rather than divert vital resources and staff time for increasing clinical STD management capacities region-wide.

Public Health strategies and targeting of men

Another deficiency in reproductive health service delivery and a major gap evident at policy and facility levels is the lack of attempts to reach men on sexual and reproductive health issues (with the exception of some localised and private initiatives). Male STD clients are treated in out-patient departments (OPD) where most STD/HIV management currently occurs. Although STD services are more readily available for men, there are difficulties with male health-seeking behaviour for stigmatised diseases like STDs/HIV and tracing male partners of infected female patients is highly problematic. This suggests a wider-than-clinic approach is necessary to encourage treatment seeking for STDs. Funding and service-delivery priorities, however, lie with clinical services; there are few non-clinic initiatives for STD management and little attempt to reach men. IEC strategies are crisis orientated and STD/HIV messages are not a priority. Outreach for community education and condom promotion is constrained by transport costs and lack of appropriate materials.

Medical practice hierarchies

The most important finding at the clinic level was the illustration of how social-behaviour factors, in particular powerful professional hierarchies, influence both current and potential practice of STD management and health service delivery in general. Professional cadres of staff, including registered nurses, nurse-midwives and public health nurses, are according to the revised national Essential Drugs List (1995), legally allowed to prescribe STD antibiotics. In practice, however, lower cadres of staff usually refuse to take diagnostic and treatment decisions even if they are trained to do so because medical practice hierarchies dictate that they must refer 'medical' STD cases to their superior. This situation is accepted by nurses and expected by doctors. Thus, even if issues of drug costs and availability, adequate diagnostics and training were resolved, medical practice hierarchies will probably continue to impede the management of STDs by MCH/FP staff. It is difficult to know how to address these except possibly through regular follow-up to ensure MCH/FP nurses trained to diagnose and treat STDs are being allowed to put their skills into practice and to ensure that STD drugs are being allowed in MCH/FP units.

Social hierarchies

The decentralisation of decision making to lower cadres of health staff conflicts with the culture of status evidenced in the 'social hierarchy' seen at all levels of Ghanaian society (Nugent 1995:34). Social hierarchies therefore uphold the medical professional hierarchies. Doctors and medical assistants, by virtue of their training and associated salary, have a higher social status than nurses. Social hierarchies also affect provider-client interactions. In rural areas, health workers have a certain 'power' over their clients and the higher social status of the nurse to the illiterate villager is often evident in their interaction. Provider attitudes towards promiscuity may make them judgmental and prescriptive in their counselling techniques, particularly since strong social hierarchies make health workers socially superior to their clients - especially illiterate villagers. Provider insensitivity contributes to clients feeling reluctant to talk about STDs/HIV and sexuality and sometimes refusal to allow vaginal examinations. Community findings indicate these topics are socially taboo and therefore require good provider interaction skills. Poor provider consultation techniques might be addressed by good quality training and follow-up of that training.

Absentee-ism

Non-residency of senior staff and absentee-ism of staff at all levels is rife among staff in the sub-districts in the Upper East Region. This is partly a function of poor living conditions which are not compatible with the social status of senior medical staff. These can be addressed by improving staff accommodation together with facility and village infrastructures although these are not purely Ministry of Health responsibilities. Absentee-ism of senior staff also occurs because of the countless seminars, meetings, workshops and training sessions which local medical 'big men' are expected to attend - and usually do because they often have perks attached (lunch or a trip to the capital) as well as serving to re-enforce the status of the individual and sometimes secure support for the facility.

Health workers also face tensions between professional and family obligations resulting in staff being absent to attend to family concerns which often take priority over professional responsibilities. Familial obligations and social hierarchies are society-wide behaviour patterns, therefore where absentee-ism of staff occurs as a result of these, it is likely to continue even if structural improvements to clinical facilities and staff accommodation are made.

Activity Paralysis

The result of this 'absentee-ism' is an activity paralysis at the facility since the professional medical practice hierarchies, discussed earlier, mean that lower cadres of staff are reluctant to take medical diagnostic and treatment decisions without the sanction of their superior, even if they are trained to do so.

Summary and discussion

The prevalence of STDs and HIV in the Upper East is low, compared to other diseases like Malaria and illnesses related to malnutrition and unpotable water. This, coupled with the obvious need for basic medical infrastructures to be improved, must call into question the appropriateness of focusing on clinical management of STDs, particularly in MCH because this does not reach men and in FP because this is so little used. Government policies would do better to target high-prevalence areas or specific high-risk groups with clinical interventions while encouraging broader-based strategies

(improving awareness of STDs among men and women and encouraging general health seeking behaviour) for low-prevalence rural areas. Where clinic-based STD management strategies *are* taken up, there are still many complex implementation issues to be clarified especially regarding the type of management approach, drug costs, training and spending priorities. Care must then be taken to address the social-behaviour contextual influences, which may negatively affect the implementation of STD management within MCH/FP and the utilisation of these services, even after clinical impediments have been rectified. The effects of social-behaviour factors can be reduced through improving the physical, clinical and management constraints, but where they are a function of socio-cultural structures and norms, they may continue to impede service provision and policy implementation.

9.1.2 Community level

Findings at the community level illustrate very different notions of power. Highly complex social hierarchies of status and respect mediate perceptions of illness and health seeking behaviour. A variety of practical life-experiences (poverty, hunger and poor water-sanitation infrastructures) also influence service utilisation and perceptions of disease priority. As well as these practical reality contexts, there are complex social contexts which influence the meaning and interpretations of health and disease; they are manifest in the dynamics of respect and reputation and gendered social power hierarchies. These have a profound effect on the willingness and ability of individuals to use reproductive (and other) health services.

Health priorities and experiences of poverty

In Binaba-Zongoire the reality of peoples' lives is one in which hunger and water-related illness is widespread and local disease priorities are linked primarily to food production and safe water and not STD/HIV infections or other reproductive health needs. Time and money is therefore put into agriculture and well/dam groups rather than for visits to the health centre.

Sexual practices

Lack of concern and awareness about STDs/HIV means that there is no urgency in making efforts to ensure that transmission risks are minimised, indeed a number of

cultural-sexual practices promote the risk, especially for women. These present a potentially serious problem given the likelihood that cross-border mobility, particularly of men for trade and employment, will increase the pool of infected people¹¹³.

Social-sexual power structures and dynamics of respect

The influence of society and of the family in sexual matters has long been recognised in Ghana as elsewhere (see for example Cain 1982; Oppong 1984, 1987; Caldwell and Caldwell 1987). In particular, the importance of conjugal communication for sexual negotiation and fertility decline - and so by extension for decrease in STD/HIV infection risk - has been established (see Bhatia and Neuman 1980; Safilios-Rothschild 1985; Oppong 1987; Alcantara 1988). In the socio-cultural fabric of the Upper East social respectability is bound up with male dominance and female sexual integrity and the discussion of sexual issues is taboo. Condom use, and STD/HIV infection are frequently associated with promiscuity which may result in violence against women. Where male-dominated conjugal relations produce a situation where women have no power to refuse sexual contact, as in the Upper East, there are serious implications for the spread of STDs and HIV. While some researchers warn against imposing western feminist views on third world gender relationships (see for example Brydon and Legge 1997:112-145), there is nevertheless a human rights imperative to protect, in a culturally sensitive way, the reproductive well-being of women.

Traditional interpretations of STDs and AIDS

Local perceptions of medical care and sexual diseases, revealed through community interviews and focus groups discussions, are still traditional with clinical care being sought largely as a last resort. Socially stigmatised diseases like STDs and AIDS can be made more acceptable through traditional causal interpretations such as curses or witchcraft. Victim blaming - especially of women - over the acquisition of STD and HIV/AIDS infections is widespread. As long as it remains so, refuge will continue to be sought in traditional explanations, perpetuating the imperviousness of communities to the messages of government and church campaigns. Medical practitioners and community members hold different perceptions of the cause and treatments for AIDS

¹¹³ Studies have shown that once a critical number, or 'pool' of infected people is reached in a community, infection rates increase among the general population (World Bank 1993). The risk of this is significantly increased through high-risk behaviour.

and STDs yet public health programmes are frequently inadequate for addressing these differences and are often culturally insensitive¹¹⁴.

Summary and discussion

Clearly there is a complex range of social-behaviour factors which mitigate against service utilisation by rural communities. The gendered connotations around blaming for and causes of STDs, underline the need to target men and male sexual practices. These findings lend further weight to the need for a broader approach, again calling into question the whole rationale for clinic-focused, female-biased interventions for STD/HIV management and reproductive health especially in areas where STDs and HIV are low prevalence. In areas like the Upper East where prevalence is currently low, interventions to improve reproductive health should be preventive: they need to be long-term, community-based and focus on men and male sexual attitudes. If the wider aims of reproductive health promoted at Cairo and Beijing are to be met, interventions need not only to treat STD cases, but to address local disease perceptions, and health seeking behaviours, and the whole cultural fabric of gender relations and socially determined hierarchies of status which determine women's reproductive decision making powers and freedom of access (spatial, financial and emotional) to medical services. The Ministry of Health cannot be expected to undertake sole responsibility for this; collaborative initiatives with other organisations, of which there are many localised examples in the Upper East, may be the way forward. Real change in attitudes and social-cultural behaviour takes generations. While paying lip-service to the importance of long term strategies, community participation and equality, donors seldom take generational time-frames or socio-cultural complexities into account and the strategies they and the national government favour remain predominantly clinical. The reasons for the continuing clinical bias and the focus on women and family planning services in the management of STDs as part of reproductive health, were made explicit as the analysis moved through the policy stages to the regional administration and the national policy development levels.

9.1.3 Regional level

At the higher bureaucratic levels, power is mediated through perceptions of status and

¹¹⁴ Frequently because health promotion programmes inappropriately utilise 'pejorative cultural codes and meanings anchored in Eurocentric and westernised ideology.' (Airhihenbuwa 1995:xii)

control of finances.

Decentralisation and ambiguities

Decentralisation policies give financial control directly to districts, bypassing the regions and creating a certain ambiguity in perception of regional roles. With the creation of the Ghana Health Service, the regional role is set to be more that of a national outpost of the executive, than of line management as was the case previously.

Regional analysis showed that regional health administrations are unable to deal effectively with the implementation difficulties facing the districts because they are constrained by national funding and administration flows, by a dearth of local resources and by the singular importance attached to the generation and control of money in concepts of power and influence. These inhibiting factors are likely to remain however the regions' role is finally consolidated.

Resource deficiencies and national constraints

Vertical funding, reporting and accountability mechanisms are still evident at regional level although these often originate at national level. While donor inputs and vertical resource flows (as for contraceptives) ensures their availability, national or donor programme directives which require vertical reporting returns perpetuate the compartmentalisation of thinking found at the service delivery level where different services are delivered by different nurses in different rooms. They also impede the ability to make local service-related decisions (for example about who to train and when to run training sessions and whether to divert funds from new training to follow-up of old training). This is particularly important with regard to the ability of regions to identify localised areas of high STD/HIV which could be targeted for specific management services.

Importance of money

The importance accorded to money for programme status and activities means few local initiatives are taken, resulting in priority areas continuing to be dictated by national and donor funding directives (for example family planning which received a number of externally funded training sessions in the research period and National Immunisation

Day a polio vaccination initiative vertically funded by UNICEF). Undoubtedly there is a severe financial shortage in the Upper East, but the continuation of earmarked funding requiring vertical accountability returns, will not help the long term development of integrated health services. It also helps perpetuate the widespread view that little can be done without funds from outside the region. The ability to attract money takes on particular importance because financial control brings power and influence. When the primary concern of regional actors is to retain monetary control and autonomy of decision making, they are less willing or able to concentrate on important supervisory and management roles which do not receive the funding priority given to specific programmes, and so do not have the same status value attached. If the 'common pot'¹¹⁵ initiative can become a reality it could facilitate a flexibility of funding which allows regionally defined priorities to be addressed.

Hierarchies of status

Status-hierarchy issues have an impact on the regions relations with other levels and the need for 'big men' to assert their power and status manifests itself in many ways. For example, few district level decisions can be made without the approval of the region; regional MoH personnel have been reluctant to collaborate with NGOs/churches working in the districts unless they (MoH) retained autonomy over management and funding decision making. This assertion of authority is perhaps heightened because regional personnel are themselves constrained by national authority. Regional programme directors are often keen to uphold national directives because this may increase the chances of promotion and perks (hotel conferences, trips to the capital or even overseas, vehicles). As a result, the willingness and ability of the regional team members to express their concerns, or to forward those made by the districts, is constrained for fear of being seen to criticise their superiors.

Summary and discussion

As well as constraints imposed by a dearth of locally generated resources and the vertical nature of national administration, accountability and funding mechanisms, the region's ability to deal effectively with district level difficulties is also impeded by a number of social-behaviour factors. The regional 'big men' are reluctant to allow district decision

¹¹⁵ The pooling of donor resources under the new Sector Wide Approach.

making, since that effectively diminishes their power, the districts' handling of budgets creates some uncertainty over regional roles and status. Priority is not given to key responsibilities of monitoring, evaluation and management which are not considered prestigious in the same way that control of financial resources is. There is still a reliance on national and external funds for non-routine activities. Hierarchies constrain regional ability to communicate district level needs to officials and policy makers at the national level for fear of being seen to usurp their status level and so inhibit chances of promotion or gratuities.

9.1.4 National level

Social-behaviour issues manifested in influence networks and power hierarchies are the most important contextual factors at this level since they influence other systems and management issues. Nationally, power is mediated through the controlling of financial resources and through influence: within the donor community and between donors and the Ministry of Health and within the MoH. Power-hierarchies are complex and there are many tensions between forces and players.

Balancing need and donor agendas

Previous chapters highlighted a real need for financial and technical support for providing STD/HIV services and health services in general to rural populations. Government spending on health is low (1.2% GDP p.a. which is estimated as only half of what would be needed to implement a minimum package of health services; Rakodi 1996:10) and the MoH is therefore heavily reliant on donor funding. The danger here is that, despite the undisputed need, the promise of money for a particular programme or activity may be tied to conditions which are not necessarily context-sensitive and MoH officials have to balance the needs and benefits against possible adversities. Aid agreements are extremely complex and trade-offs, which often occur through informal discussions and private meetings, are practically impossible to document. There is still a real concern among MoH officials that donors continue to manipulate and drive their own agendas; inevitably, where the need is great, the MoH is likely to concede under pressure. Donor agendas are far less overt now and MoH lead-taking in decision making has been increasing in an environment that is much more conciliatory than a decade ago. Notwithstanding the undoubted growth in MoH autonomy, at a macro decision-making level the consensus is still that 'he who pays the piper calls the tune'.

Power and money: MoH interests

As at regional level, the holding of money brings power to units and individuals which may encourage the MoH to agree to aid conditions without thorough thought for the implications. International agendas (either advocated by donors or taken up by leading Ministry officials) are backed up with money which secures power for particular programmes (Safe motherhood; family planning; STD/AIDS) or units (MCH, NACP) allowing them greater political power in internal negotiations and decision making. Programme, unit and department heads who receive earmarked funds and technical support are understandably inclined to secure these resources by preserving the status quo which upholds vertical organisational, administrative and accountability structures. There are also the extra perks for playing the donors' tune: hotel conferences, cocktails, overseas trips and so on which all help to reinforce the status and influence of particular units or individuals. The potential destructiveness of powerful individuals in a Ministry which relies on collaboration and negotiation between units, was shown in the case of the former director of medical services who gained the power to secure or jeopardise funding for programmes and units and override the requests or decisions of others.

Distancing the local voices

The voices of the service providers and the community are conspicuously absent from policy debate. In this respect both national policy makers and international donors have been exceptionally bad at making efforts to understand the contextual factors at provider and community levels. It is more difficult for donors to gain an accurate picture of local need since they rarely have a presence below the national level, although they could fund initiatives to facilitate an understanding of local issues which, despite 'community participation' rhetoric, is seldom the case. National MoH hierarchies and the supreme powers of the big men also constrain local voices and their representatives. Regional personnel are reluctant to articulate real needs and concerns at national level for fear of being seen to criticise superiors on whom their jobs - and promotion - depend. Those organisations (often NGOs) more closely involved in implementation are sidelined, ostensibly because their by-passing of government bureaucracy arouses anger in the MoH. Otherwise they may be heard - at multi-participatory policy seminars - but not listened to or taken seriously because policy decisions are influenced primarily by external and monetary agendas.

Summary and discussion

The complex interplay of national and international interests serves to keep local voices distant and results in policies which uphold entrenched vertical, segregated, bio-medical concepts of reproductive health. These mirror the international ideologies held by donors whose support favours clinical, bio-medical structures which rely on foreign 'expertise' and advice as well as western supplies of drugs and equipment. The various guidelines for reproductive health are primarily clinical and 'integration' of STD/HIV and MCH/FP services largely involves 'adding in' STD management at certain points of ante-natal and family planning service delivery. The multiplicity of programmes and units responsible for the different aspects of reproductive health causes confusion and impedes effective co-ordination of activities and responsibilities. It is difficult for nurses on the ground who receive directives from a number of different national bodies to try to co-ordinate them. Essentially it simply leads to a compartmentalisation of attitudes of providers - and so of service delivery - which, inevitably, reflect national level divisions.

9.1.5 Conclusions

While there are various policy-specific clinical factors and general health systems and management factors which influence the course of policy, this multi-level analysis has made it clear that it is the behaviour, attitudes and powers (manifest or perceived) of the actors involved which can confound the progress of policy at every level and perpetuate the gap between policy elites and local providers and communities.

At the clinic level we see a medicalisation of power: doctors are professionally higher than nurses and are not keen for lower cadres to gain and use the medical knowledge which gives them their power - thus they require nurses to refer STD cases to them. Social hierarchies give health workers 'power' over their clients and the higher social status of the nurse to the illiterate villager may be evident in their interaction. As a result, the client may be reticent in talking about STD symptoms or issues of sexuality. At the community level, social-sexual power structures are gendered, largely conferring reproductive decision making powers on the men. At an administrative level, professional status and social hierarchy are linked to the holding of authority, manifested particularly in the control of financial resources. Political power and decision making at national level depend on connections, access to money and the ability to assert

autonomy.

Each of these may impede policy processes. The advantage of multi-level research is that it enables an understanding of what happens at each of the different levels, how the factors interact and how the different concepts can be synthesised. It allows the macro and micro dimensions of power networks and manifestations to be linked and addressed in order to make sense of the whole process and to make policies more responsive to local needs. The clinic and community findings argue for a wider-than-clinic approach to reproductive health and the flexibility to allow the specific targeting of high prevalence areas for clinical STD management activities. However, current policies are clinic-focused and female biased, with the different components of reproductive health frequently segregated.

This gulf between the policies based on what MoH and donors think community and service needs are and the reality of the actual need of villagers and of health workers, is perpetuated by national power hierarchies and elite agendas which impede local voices from being heard and taken seriously. The local medical, social and sexual hierarchies seen at the clinic and community levels are not well understood by national decision makers and the impediments they can pose to service delivery and utilisation therefore go largely unheeded. Clearly there is a need for linkage, co-ordination and synthesis to be established between programme components, between sectors and between levels. The question of how this may be achieved constitutes the brief discussion of the final section of this chapter.

9.2 The way forward: distant voices in the corridors of power?

'The problem of what officials see as the felt-need and what ordinary Ghanaians think they need, will remain a perennial issue until some kind of linkage is established.'
Senah 1996:213

Given the constraints posed by the entrenched verticality of current programme structures, the compartmentalisation of attitudes and the power hierarchies of the status quo, it would be realistic to conclude that the implementation, within the existing structures, of 'integrated' reproductive health strategies which are capable of addressing wider gendered community health needs, will remain an impractical ideal. Even where these ideals are articulated in policies and guidelines, they may remain unachievable because of the hierarchies of current structures and attitudes. The challenge is how to

allow forthcoming policies and fresh approaches to be influenced more by concerns and needs of those 'on the ground' and then translate them into a responsive reality.

A detailed analysis of potential solutions is beyond the scope of this thesis, but is an area which must be taken up in future research on reproductive and other health policies. Some lessons and suggestions can nevertheless be drawn from this research. The role of 'intermediaries' to communicate local level reproductive health issues to higher levels, the co-ordination of multi-sectoral inputs and the development of active multi-sectoral and long term collaboration between implementing bodies could be crucial in achieving a diminution of the policy-practice gap.

At a national level decision makers must be prepared to make provisions for local voices to have an input in strategy development. To achieve this, a more proactive role for 'intermediaries', such as regions, NGOs and churches, could be advocated. The regions are the most obvious choice since they are usually well aware of what the district and sub-district problems are, but in Ghana the regional voices are muted on the national stage by power-hierarchies which mitigate against criticism or upsetting the status quo. Active intermediary and communication roles may be more effective through churches and NGOs, who work locally in health care, since they can speak independently of the MoH and major international donors (although they may work through or with donors and international NGOs). This situation, however, relies on these organisations having a presence at national level, which probably involves going through a national level organisation or an international NGO. In this case good national level relations between Ministry of Health, national/international NGOs and religious organisations are also necessary - currently there is some tension between international NGOs and government bodies. The willingness of national and international decision makers to listen to local-level voices once they have an outlet may be more difficult to secure since these voices may be critical of national decisions or expose the ineffectiveness of some policies - this may be perceived as undermining potential funding opportunities.

One of the key findings regarding reproductive health policies at the local level was the need for a multi-sectoral approach to address the complex social, sexual and gender hierarchies that mitigate against (female) health-seeking for STDs and some other reproductive health services and render current clinical services and bio-medically focused policy initiatives in-appropriate. At a policy level this requires a co-ordination of inputs and policy initiatives to ensure a spreading of resources and avoid duplication of

efforts.

At the national level, both 'population' (family planning) and AIDS are considered multi-sectoral issues of public health importance. Both these programmes attract large cuts of donor health sector funding. Population activities, largely through the UNFPA and USAID Country Programmes, are supposed to be co-ordinated and overseen by the National Population Council, an 'independent' parastatal. This body has important potential as a co-ordinator of multi-sectoral reproductive health inputs and activities, but in reality its four years of existence in its current form have failed to quell internal power tensions and the potential remains to be realised. The National AIDS Control Programme in the Disease Control unit in the MoH is meant to co-ordinate AIDS activities - including STDs - but it does not have particularly high status, has suffered frequent changes in senior staff and does not effectively link with other sector ministries. STDs and HIV/AIDS are therefore rendered a health, and not a multi-sectoral, responsibility, and as such cannot effectively address the social-sexual behaviours that influence their spread. Perhaps HIV/AIDS (and STDs) can only become multi-sectoral if an independent body is set up which would liaise with, and co-ordinate initiatives in, all relevant sector ministries. The prevalence of these diseases in Ghana is probably not high enough to warrant such a structure being set up - other countries where this model has been followed, like Kenya and Zimbabwe, have far higher HIV prevalence rates in the general population.

The lack of co-ordination and communication between the different units and bodies with a responsibility for different aspects of reproductive health perpetuates the focus on quantifiable clinical and clinic-based public health strategies which go against the multi-sectoral ethos accorded to population and AIDS issues. The most significant result of this is that it leads to a divorce of the clients from their social context, a context which it is essential for policy makers to understand if reproductive health services are to respond to real needs.

It may be unrealistic to expect local needs to be consistently articulated at national level or for national level structures to effectively co-ordinate inputs and strategies to deal with multi-sectoral community needs. In this case, there needs to be the flexibility for regional and district levels to address them. At the implementation level, chapters four and five suggested that the Ministry of Health alone cannot address the magnitude of the problem of reproductive health service delivery, particularly the public health and

community level components. The way forward may therefore be for active partnerships to be built up with sector ministries, NGOs, religious and other local organisations at regional and district levels. Regional health management teams could have an important role in encouraging and co-ordinating collaborative initiatives between the health sector and organisations operating locally in health and related areas. Such partnerships will need to be long-term in conception and able to work with and through local leaders from the inception. There are several encouraging small scale examples of localised collaboration efforts in the Upper East.

Bawku District hospital is one example of a successful partnership. It is an MoH hospital, and the basic salaries of its staff and general running costs are therefore covered by the Ministry of Health, but it is directly supported by the Presbyterian mission (international partner churches give funds to the local, indigenous church leaders). Facility data collected during this research showed its training standards, equipment and drugs supplies to be better than those at the regional hospital and Bawku is generally considered the leading hospital in the region.

An example of a specific reproductive health partnership initiative is provided by a Ministry of Health/Ministry of Agriculture project to distribute condoms to rural men through Agriculture Extension Workers who represent the largest coverage of personnel of any Ministry in the country. Agriculture workers were sensitised to the issues around condom promotion and skills for interacting about sensitive topics. The reported response from agriculture workers and local farmers was positive. Lack of follow-up and conflict over which Ministry should take responsibility for the initiative eventually led to its collapse, but it illustrated the potential of such a community level intervention using accepted and respected male figures to target local men.

There are a number of private reproductive health initiatives in the Upper East of which those run by the local NGO Rural Help Integrated are particularly notable. The NGO, based in Bolgatanga, is run by a local 'big man' (who set it up 'in my spare time'; Interview, Odoi-Agyarko 1997) whose wife heads the national MCH Unit of the Ministry of Health in Accra. His contacts mean he has been able to attract funding from big donors like UNFPA. Initiatives are very localised and are aimed at making family planning and reproductive health services more acceptable in rural communities. Local village leaders have been targeted and community interest raised through creative social activities including dramas and locally made films which have sought to redefine family

planning in ways suggested by and acceptable to the community and raise awareness of sexual health issues including STDs and AIDS. The activities of Rural Help Integrated have become known throughout the region and members of the district assembly and the clinic committee in Binaba, interviewed for the sub-district case study, cited these initiatives as examples of innovative strategies with the potential to facilitate long-term attitudinal and behaviour change.

A positive example of a multi-sectoral development initiative which sought to address gendered social attitudes around the status of women as well as improve practical elements of rural life (food production, safe water provision and now health) comes from Yelwoko village, Bawku-West district. The work of the Anglican mission here and throughout the district, encapsulates all the major requirements cited in development literature for successful development: it has been long term (25 years to date), involved community leaders and members from the outset and has covered all sectors regarded as important by the community: agriculture, income generation and, most recently, clinical health care. Over a generation, the mission's projects have built up links with members of prominent families in the community, gaining trust and respect until the situation has been reached where the local priest (who is from the Chief's family) has now taken over decision making, running and monitoring of projects and writes proposals for aid from local and international agencies based directly on community based needs and capacities. Local church leaders provide a co-ordinating capacity for all development projects in every sector throughout the district as well as in the regional capital Bolgatanga. All NGOs and other 'development' agencies and church groups in the area work through them¹¹⁶ and, as members of the communities themselves, the church leaders are also directly involved in local government structures and liaise with regional sector Ministries on a regular basis.

Successful examples of collaborative projects are often very localised and ad hoc. Developing effective co-ordinating and 'intermediary' structures to voice local concerns and aid the development of local collaborative initiatives is beset with problems. Nevertheless, as long as MCH/FP and STD/HIV programmes remain vertically conceived, funded and organised, and as long as attitudes of regional and national administrators and bureaucrats perpetuate the status quo which blocks a free expression

¹¹⁶ The Anglican leaders liaise closely with a number of indigenous NGO initiatives including the Binaba Area Community Health project and the Agriculture Rehabilitation Centre for the Blind, for which support is solicited from overseas but which is overseen and monitored by independent committees of key players from the district.

of local concerns, intermediaries outside the Ministry of Health and local collaborative initiatives offer perhaps the only venue for representing local voices and acting on locally articulated need. Without intermediaries and collaborators, reproductive health policies will continue to be mere rhetoric endorsed by international donors which have little relevance or impact on the nurses struggling in deprived clinics and the Laadis of Ghana's villages. Without a knowledge of local voices, analysis of health issues will remain 'essentially a debate among professionals based on *their* perceptions' (Heap and Rampole 1991, quoted in Butchart 1998:170) rather than on the reality.

9.3 Towards the Future?

The Search (Kwesi Brew)

*The past
is but the cinders of the present,
The future
the smoke
that escaped
into a cloud-bound sky.*

The policy analysis findings of this research have revealed three key points which contribute to new knowledge in the areas of policy analysis and health policy:

- Notions of power and influence mediate actors' actions at every stage of the policy process.
- An understanding of the multi-level dimensions of policy and a linking of macro and micro elements is essential for understanding and analysing how policies are developed and implemented.
- To develop policies which are sensitive to local needs, mechanisms for linkage between the levels must be established to allow local voices to be heard and acted upon.

Ghana has for decades been seen as a leader in African political and economic thought and the Ghana government and civil service have many capable individuals. Nevertheless, the confluence of factors illustrated in this thesis form a barrier to allowing community and district voices to be heard and taken seriously so that the worlds of people like Laadi (described in

chapters four and five) will continue to be centuries away from the conceptual debates of researchers and decision making elites. An understanding must be reached of the power interests that drive individuals at every level of the policy process, and mechanisms must be developed to mitigate the effects of these by enabling the realities on the ground and voices from the localities to be not merely observed and listened to but taken seriously and acted upon. Unless these can be achieved, then, as in the poet's vision of Ghana, the search for appropriate policies which translate into effective health care will remain merely the smoke of rhetoric and health services will become merely the cinders of unachieved ideals. The contexts in which policies are made and implemented and in which people seek health care and live their lives will not change quickly, but the way decision makers and researchers see, understand and act upon them must.

APPENDIX 1

APPENDIX 1 INTERVIEWS CONDUCTED

Table A Formal Interviews conducted at the National Level

Ministry	Interviewee's name and position	Date
Ministry of Health	Mr Donkoh } Deputy Ministers	1997
	Nana Acheampong } (Permanent Secretaries)	1997
	Dr Otoo, Director of Medical Services	1996, 1997
Policy Planning Monitoring and Evaluation Unit	Dr Tinorgah, External Aid Co-ordinator	1996
	Mr Ampedu (accountant)	1997
	Mr Paul Smithson, financial advisor (ODA/DFID)	1997
Public Health Division	Dr Ahmed, Director	1996
	Dr Bughri, Director	1997
Mother Child Health Unit	Dr Odoi-Agyarko, Director	1996, 1997
National AIDS Control Programme	Dr Asamoah-Odei, Director	1996, 1997
	Dr Ahadzie, Director	1997
Nutrition Unit	Essie Amarfio, Programme Officer	1997
Health Education Unit	Mr Ibrahim, Director	1996
Institutional Care Division	Dr Mensah, Director	1997
Human Resources Division	Dr Dela Dovlo, Director	1997
Health Research Unit	Dr Sam Adjei, Director	1996, 1997
	Mercy Ablordey, Health researcher	1996, 1997
	Patience Cofie, Health researcher	1996, 1997
Korle-Bu National Teaching hospital	Dr Richardson, Obs-Gyny consultant	1996
	Mrs Ashitey, Head, Family Planning Unit	1996
	Ms Amofah, Public Health nurse, Outpatients Department	1996
Adabraka Poly clinic (National STD Clinic)	Dr Mensah, STD Co-ordinator	1997

Appendix 1, Table A cont.

Ministry	Interviewee's name and position	Date
National Council on Population	Dr Turkson, Director Dr Ampomah, Head Reproductive Health Unit Dr Moses Aikens, Senior Programme Officer/ Research Co-ordinator	1996 1997 1996
Ministry of Finance Social Sector Policy Unit	Mr Quist-Therson, Head SSPU	1996, 1997
Ministry of Local Government	Mr Quarshie, Senior Officer	1997
Parliament	Mr Donu-Nartey MP (Chief Whip, NDC) Former Chair Parliamentary Select Committee on Health.	1997

Appendix 1, Table A cont.

Donor	Interviewee's name and position	Date
USAID	Dr Pam Wolf, Chief Officer of Health, Population and Nutrition to 1997	1996
	Dr Halliday, Chief Officer of Health, Population and Nutrition 1997 on	1997
	Dr Ababio, Deputy Officer of Health, Population and Nutrition	1996
EU	R Skinnebach, Country Co-ordinator	1996
ODA/DFID	Dr Bamisaye, Head Health and Population Programme to 1997	1996, 1997
	Dr Linda Humphries, Senior Health and Population advisor	1996
	Dr Liz Gaere, Head Health and Population Programme 1997 on	1997
	Dr Pauline Owusu, STD/AIDS programme officer	1996
GTZ	Mrs Chuff, Head Regional AIDS Programme	1996
CIDA	Dr Kounda, Director AIDS programme	1996, 1997
DANIDA	Ms Kyei, Public Health Advisor	1996
Uniccf	Dr Jarman Guland, Country Director	1996
	Ms Stella Nyinah, Reproductive Health Officer	1997
WHO	Dr Fleischer-Djaletto Health and Population Representative	1997
	Dr Avokey Health and Population Representative	1997
UNAIDS	Dr Cynthia Eledu, Director	1997
UNFPA	Mr Owusu-Sarfo, Country Director	1996
World Bank	Health and Population Advisor	1997

Appendix 1, Table A cont.

International NGO	Interviewee's name and position	Date
Save the Children	Kimberly Rose, Health Programme Officer	1996
CARE International	Peter Newson, Country Director	1996
Action Aid	Regional level interviews (see Table B)	1997
World Vision International	Dr Joe Riverson, National Director	1996

National NGOs	Interviewee's name and position	Date
Planned Parenthood Association of Ghana	Dr Joanna Nerquay-Tetteh, Director	1996
	Ms Mensah and Ms Addy, FP nurses at clinic in Accra	1996
	Kumasi regional team representatives	1995
Ghana Red Cross	Youth Department representative	1996
National Council on Women and Development	Regional interview (see Table B)	1997
Thirty First December Women's Movement	2 HQ representatives	1997

Appendix 1 Table A cont.

Religious Organisations	Interviewee's name and position	Date
Christian Health Association of Ghana	Ms May Kissiedu, Director	1996
Christian Council of Ghana	Rev Konadu, Director	1996
National Catholic Secretariat	Josephine Val-lare, Director	1996
Ahamadiya Muslim Mission	Quainoo Yusuf, Moslem Family Counselling Services Alhaj Baba Issa	1996 1996

Academic Bodies	Interviewee's name and position	Date
School of Public Health, University of Ghana, Legon	Prof Ofosu-Amah, Director Dr Phylis Antwi, senior lecturer (former director NACP) Dr Matilda Pappoe, senior lecturer	1996, 1997 1996, 1997 1996, 1997
Population Impact Programme, Department of Geography, University of Ghana, Legon	Prof Nabilia, Director	1996
Ghana Institute of Journalism	Mr Newton, Director	1997

Appendix 1, Table A cont.

Professional Bodies	Interviewee's name and position	Date
Ghana Nurse Midwives Council	Tetteh Carboo, Executive Secretary	1997
Ghana Registered Nurses Association	Mrs Banga, Executive Director	1997
Ghana Registered Midwives Association	Florence Quarcopone, Executive Director	1996
Pharmacy Council of Ghana	Mr Corquay, Executive Director	1996
Pharmacy Society of Ghana	Mrs Addo-Attuah, Executive Director	1996

Private Organisations and Media	Interviewee's name and position	
Ghana Social Marketing Foundation	Susan Saggoe, Adolescent Programme Manager	1997
	Kodjo Lokko, Marketing Manager	1997
JSA Consultants	Dr Joe Anan, Director Dr Moses Aikens Ms Helen Dzikunu	1996, 1997 1996, 1997 1996, 1997
Media Network on AIDS	Mr Wellington	1997
Journalists working for <i>Independent, Chronicle and Daily Graphic</i>	Various	Numerous informal conversations

Appendix 1, Table A cont.

Medical Schools and training Institutions	Interviewee's name and position	Date
Ghana Medical School, Korle-Bu	Lecturer, Community Health Department	1997
Nursing School, Korle-Bu	Ms Quarshie, Director FP Tutor Obs and Gyny Tutor	1997 1997 1997
Midwifery School, Korle-Bu	Director	1997
Kumasi Medical School	Health Education Lecturer	1997
Kintampo Training School	Paul Arthur Director	1997
SRN Training School, Bolga	Director	1997
Midwifery Training School, Bolga	Director	1997
Koforidua Regional Hospital MCH/FP Unit (National Pilot for training of FP nurses in STD management)	Sr Quarshie, Medical Officer In-Charge 2 FP nurses being trained	1997 1997

Appendix 1 cont.

Table B Interviews Conducted in the Upper East Region

Ministry and Position	Interviewee's name	Date
Ministry of Health		
Regional Director of Health Services	Dr Agogo	1996, 1997
Principle Nursing Officer, Public Health	Dr Amankua	1996, 1997
Regional Health Services Administrator	Mr Brobbey	1996, 1997
Principle Nursing Officer (MCH/FP)	Ms Abaseka (Actg)	1996, 1997
Principle Nursing Officer (PH)	Mrs Anderson	1996, 1997
Regional STD/HIV Officer	Mr Angyogdem	1996, 1997
Director Pharmaceutical Services	Mr Amiah	1996, 1997
Regional Nutrition Officer	Mr Karim	1996, 1997
Regional Health Educator	Mr Bozie	1996, 1997
Ministry of Education		
Regional School Co-ordinator	Mrs Apasnaba	1997
Non-Formal Education Division	Mr Jefo	1997
Ministry of Agriculture		
Deputy Director	Mr Ayariga	1997
Regional Extension Officer	Mr Yeboah	1997
Regional Women in Agriculture	Ms Kambonga	1997
Representative		

Appendix 1, Table B cont.

Ministry and Position	Interviewee's name	Date
Ministry of Social Welfare		
General Health Representative	Mr Ayesakiya	1997
Other Municipal Structures		
District Assembly	Mr Abas, District Co-ordinating Director, Bolgatanga.	1997
NGOs and Religious Organisations		
Action Aid	Nana Fosu, AIDS programme director	1996
Rural Help Integrated	Dr Odoi-Agyarko, Director	1997
Red Cross	Youth Representative, Accra	1995
National Council on Women and Development	Mrs Mumwuni	1995
National Catholic Secretariat	Director	1995
Catholic Relief Services	Lucy Awuni	1997
Anglican Mission	Fr. and Mrs Ayeebo Fr. Anyindana Fr. Edwin Abanga	1995, 1996, 1997 1995, 1996, 1997 1995, 1996, 1997

Appendix 1 cont.

Table C District Level Interviews, Bawku-West

Body	Interviewee	Date of Interview
District Health Management Team	Dr Quaye, District Medical Officer Mr Saggrey, Binaba I-C Olivia, PHN, Binaba Health Centre Fr. Ayindana, Anglican mission	1997 1996, 1997 1996, 1997 1996, 1997
District Assembly	Fr. Anyindana - DA man, Bawku West Mr Appiah - DA man, Bawku West	1997 1997
Binaba Area Community Health Programme	Director, Vivian	1996
Anglican Mission	Fr. Anyindana Fr. and Mrs Ayebo	1995-7 1995-7
Agric Extension Officer	Steven Agobre	1997

Health Providers Interviewed in Upper East Region 1996-7

Staff interviewed, Total numbers of staff and facilities, by facility type.

Type of health facility	Number of health facilities visited	Total number of facilities in UER*	Number of staff interviewed at facilities visited	total number of staff at facilities visited
Hospital	4	4	25	611 (including those on secondment and outreach)
Health Centre	8	13	32	88
Private clinic	5	8	9	12
Mission clinic	2	20	5	11
MCH centre	4	N/A	7	14
Community clinic	3	11	3	6
Total	26	c.77	81	742

*These figures should not be considered exact. They are taken from 1995 regional annual report data although other sources give different figures. Not all categories can be extrapolated from official figures.

Appendix 1, Table C cont.

Staff interviewed, by rank, Upper East Region 1996-7

Staff Type	# Interviewed
Doctor	4
Medical Assistant	8
Senior nursing officer	6
State registered nurse midwife	10
State registered nurse	12
Public health nurse	7
Community health nurse midwife	7
Community health nurse	15
Staff/Enrolled nurse	9
Other (lab/pharmacy personnel)	9
Total	87

Informal interviews with community members and farming group representatives
5 focus group discussions with villagers from 3 villages

APPENDIX 2

Appendix 2 Health facilities visited during fieldwork, Upper East Region 1996-7

Facility	Dr or MA	Snr NO I/C	SRN/MW	PHN	CHNMW	CHNs	snr staff nurse/ staff enrolled nurse	Other	Total (total no. medical staff)
Bolgatanga District									
Bolgatanga Regional Hos		1	1		1	3	3		7 (30, including. those on outreach and transfer)
Bolga HC	1			1		3		1 dispensing technician	6 (12)
Police Clinic, Bolga	1						1		2 (2)
Asankunde private clinic, Bolga	1		2						3 (3)
Unity Private Clinic		1							1 (1)
Kongo Private Clinic		1							1 (1)
Kongo Catholic Mission Clinic			1				1		2 (5)

Appendix 2 cont.

Facility	Dr or MA	Snr NO I/C	SRN/MW	PHN	CHNMW	CHNs	snr staff nurse/ staff enrolled nurse	Other	Total (total no. medical staff)
Bawku West District									
Yelwoko	1								1 (1)
Binaba HC	1		2	1		1			5 (8)
Zebilla HC/hos	1		1		1				3
Bawku East District									
Bawku hospital	1	2	4 (mws)	1					8 (10 snr posts, 218 nurses including. outreach and transfer)
PHC/MCH centre, Bawku			1	1		1			3 (c.6)
Islam maternity home, Bawku			1						1 (2)
Kadana private clinic, Bawku			1						1 (2)
Widana HC, Bawku E	1				2		1		4 (22 including outreach)
Garu HC			1 (mw)			1			2

Appendix 2 cont.

Facility	Dr or MA	Snr NO I/C	SRN/MW	PHN	CHNMW	CHNs	SSN/SEN	Other	Total (total medical staff)
Navrongo District									
Navrongo Dist hos	1		3(fp)				1		5 (150)
MCH/FP clinic of Nav hos					1				1 (3 + 7 on outreach)
Paga clinic BE	1					2	1		4 (7)
Chiana HC, BE			1 (I/C)		1		1		3
Sandema District									
Wiaga Cath clinic Builsa			1			1			2 (8)
Siniensi clinic, Builsa					1 (I/C)				1 (3)
Chuchuliga health centre								1 disease control officer	1 (3)
Sandema dist hos	1	1					1		3 (11)
MCH/FP/ANC block, Sandema			1	1					2 (4)
Bongo District									
Bongo HC	1		1	1		2			5 (11)

APPENDIX 3

Appendix 3 Documents Analysed during fieldwork and write-up

I) Acts, Laws, Guidelines

Acts and Laws (by date)

Government of Ghana (GoG) (1985) Criminal Code (Amendment) Law P.N.D.C.L. 102 (on abortion), Accra, 1985.

Government of Ghana (GoG) (1992) *Constitution of the Republic of Ghana* P.N.D.C.L. 282

Government of Ghana (GoG) (1992) PNDC law 207 (Rights to local government), Accra, 1992.

Government of Ghana (GoG) (1992) Food and Drugs Law 1992, P.N.D.C.L. 305B

Government of Ghana (GoG) (1993) The Civil Service Law, PNDC Law 327, Accra, 1993.

Government of Ghana (GoG) (1993) Local Government Act, Act 462, Accra, 1993.

Government of Ghana (GoG) (1994) National Development Planning Commission Act, Act 480, Accra, 1994.

Government of Ghana (GoG) (1994) National Development Planning (System) Act, Act 480, Accra, 1994.

Government of Ghana (GoG) (1994) Local Government Instrument 1994 L-I 1589, Accra, 1994.

Government of Ghana (GoG) (1994) *National Population Policy* (revised edition 1994), NCP, 1994.

Government of Ghana (GoG) (1994) *Revised National Population Policy - Action Plan* Volumes I - VI, NCP, December 1994.

Government of Ghana (GoG) (1994) National Population Council Act 1994, Act 485

Government of Ghana (GoG) (1994) Pharmacy Act 1994, Act 489

Government of Ghana (GoG) (1996) Health Service and Health Management Bill, May 1996

Government of Ghana (GoG) (1996) Ghana Health Service and Teaching Hospitals Act 1996, Act 525 (December 1996)

Government of Ghana (GoG) (1996) Food and Drugs (Amendment) Act 1996, Act 523

Government of Ghana (GoG) (1996) The Constitution of the Republic of Ghana (Amendment) Act 1996, Act 527

Government of Ghana (GoG) (1997) Ghana Health Service Act, 1997

Directives and Guidelines (by subject)

Institutional Reform

GoG (1994) *The new local government system*, MoLocal Government, 1994.

GoG (1996) *Ghana - the new local government system*, 2nd edition, MoLocal Government and Rural Development, November 1996.

GoG, Republic of Ghana (1996) *Institutional Reform in the Health Sector*, MoH, December 1996

Health Sector

GoG, Republic of Ghana MoH (1996) *Health Sector Five Year Programme of Work*, Draft, August 1996.

GoG, Republic of Ghana MoH (1997) *Health Sector Five Year Programme of Work*, Final POW, February 1997.

GMoH, Republic of Ghana MoH (1995) *Medium Term Strategic Framework for Health Development*, MoH, August 1995.

GMoH, Republic of Ghana MoH (1995) *Medium Term Health Strategy: Towards Vision 2020*, MoH, Accra, September 1995.

GMoH (1995) *Medium Term Strategy for Health: Technical Guidelines for the control of Selected Disease for District and sub-district levels*, MoH, 1995.

GMoH, Republic of Ghana MoH (1994) *Policies and Priorities for the Health Sector 1994-5*, MoH, May 1994.

GoG, Republic of Ghana *Code of Conduct for Nurses and Midwives*, Nurses and Midwives Council.

GoG, Republic of Ghana (1995) *Extracts of administrative rules and regulations and professional codes*, MoH May 1995.

GMoH HQ (1997) *1997 Approved Budget Estimates, Guide for Operation*. Internal document from Minister for Health to UER Regional Administration, April 1997.

GMoH, PPME (1997) *Spreadsheets and finance data on recurrent and capital funding and expenditure*.

Safe motherhood/reproductive health

GMoH (1994) *Guidelines for Health Education on Safe Motherhood*, MoH, September 1994.

GMoH (1994) *Clinical Management Protocol on Safe Motherhood*, MoH, September 1994.

Government of Ghana (GoG) (1996) Republic of Ghana (1996) *National Reproductive Health Policy and Standards*, MoH, April 1996.

STDs/AIDS

Ghana MoH (GMOH) (1991) AIDS Counselling manual, NACP, MoH, Accra, 1991

GMOH (1992) *Guidelines for AIDS prevention and control. Activities at regional and district levels*, 1992.

GMOH, NACP (1996) *Sexually Transmitted Diseases - Guidelines for Management*, NACP, March 1996.

Government of Ghana (GoG) (1996) Republic of Ghana Essential Drugs list and national formulary of Ghana with Therapeutic guidelines. MoH, Third edition, 1996.

2) MoH documentation (reports)

Reproductive health/population

Ghana MoH *Maternal and Child Health and Family Planning Annual Report 1993*, Technical co-ordination and Research division, MoH, Accra, 1994.

Ghana MoH *Maternal and Child Health and Family Planning Annual Report 1994*, Technical co-ordination and Research division, MoH, Accra, 1995.

Ghana MoH *Maternal and Child Health and Family Planning Annual Report 1995*, Technical co-ordination and Research division, MoH, Accra, 1997.

National Population News Bulletin 1.3 1996

NTBA Secretariat (1993) 'Fieldwork for the Implementation of the follow-on programme 1992-1996.

UER TBA Evaluation Report 1992, Executive summary.

STD/AIDS

Ghana MoH (1993b) *1992 Annual report, Epidemiology Division*, MoH, Accra, 1993.

GMOH, Disease Control Unit *1993 Annual Disease Control Report*, MoH 1994

GMOH, *AIDS in Ghana: Background, Projections, Impacts, Interventions*, NACP/USAID, Accra, September 1995.

Ghana MoH *HIV Sentinel Surveillance 1994*, Epidemiology Division, Disease Control Unit, MoH, Accra, April 1995.

Ghana MoH *HIV Sentinel Surveillance 1995*, Epidemiology Division, Disease Control Unit, MoH, April 1996.

Ghana MoH *HIV Sentinel Surveillance 1996*, Epidemiology Division, Disease Control Unit, MoH, 1997.

Ghana MoH *AIDS Surveillance Report July-December 1996*, Disease Control Unit, MoH, February 1997.

GMoH, Adabraka STD Clinic (1995-7) *Statistics of patient load and STD/HIV incidence data 1995-1997*, Adabraka, 1997.

National MoH Reports

Ghana MoH *Ministry of Health Annual Report 1991*, MoH, Accra 1992

Ghana MoH *Ministry of Health Annual Report 1992*, MoH, Accra, 1993.

Ghana MoH *Ministry of Health Annual Report 1993*, MoH, Accra, 1994.

Ghana MoH *Ministry of Health Annual Report 1994*, MoH, Accra, 1995.

Ghana MoH, Technical Co-ordination and Research Division (1994) *Annual Report 1993*, MoH 1994.

Ghana MoH, Public Health Division (1995) *Annual Report, Public Health Division 1994*, MoH 1995.

Regional MoH Reports

Ghana MoH (UER) (1994) *Upper East Region Annual Report 1993*, UER RHMT, 1994.

Ghana MoH (UER) (1995a) *Upper East Region Annual Report 1994*, UER RHMT, 1995.

Ghana MoH (UER) (1995b) *Regional Administration Data Base*, RHMT, Bolgatanga, 1995.

Ghana MoH (UER) (1995c) *Regional Hospital Annual Report 1995*, Bolgatanga, 1995.

Ghana MoH (UER) (1996a) *Upper East Region Annual Report 1995*, UER RHMT, 1996.

Ghana MoH (UER) (1996b) *Regional Hospital Annual Report 1996*, Bolgatanga, 1996.

Ghana MoH (UER) (1997) *Upper East Region Annual Report 1996 - Draft*, UER RHMT, 1997.

3) National medical training curricula (by date)

Addo-Atuah 'Genito-Urinary Tract Infections', lecture notes from Curriculum for Fellowship of West African Pharmacists (undated)

GMoH (1990) MCH Modular Curriculum.

GNMC (Ghana Nurse and Midwives Council) (1993) Curriculum for State Registered Nurses.

GMoH (1996) Curriculum for Peri-Operative Care Nursing Programme, July 1996, HRDD, MoH.

GMoH (1996) Curriculum for Critical Care Nursing Programme, July 1996, HRDD, MoH.

Midwife Training school, Korle-Bu, Curriculum/brochure. 1996.

GMoH (1997) In-service training policy, HRD, March 1997.

4) Donors/NGOs - reports, country programmes, consultancies (alphabetical)

Action Aid Ghana/Ghana Red Cross Society (1996), Youth and AIDS Peer Education Project - Project Evaluation, Dec 1996.

Ahamadiya Muslim Mission, Ghana - introductory brochure

CARE international - 2 brochures

CEDPA, 'Empowering women through access, choice and participation' - activities brochure

CEDPA, 'The adolescent and gender project for sub-Saharan Africa' - activities brochure

Christian Council - 3 booklets produced for Christian Home Week: 'Active Parenting' 1995, 'Women's empowerment' 1996, 'The family and our environment' 1997.

Christian Health Association of Ghana (CHAG) (1996), Annual Report 1995-6.

Canadian International Development Agency (CIDA) (1996), *West African Project to Combat AIDS*, Ghana Activities sheet; training package for Pharmacists on STD management.

CIDA (Mayhew and Avle; HRU) (1996) *Pharmacy Outlets Survey: STD management*, report prepared for CIDA, September 1996.

DANIDA, 'Introducing HSSP - the Ghana-Denmark Health Sector Support Programme', DANIDA, Accra, undated.

DFID (ODA) (1993) 'Detailed review of HIV/AIDS IEC and condom promotion activities in Ashanti region', report by ODA consultants, 1993.

DFID (ODA) (1992) MoH project proposal: Health sector Aid Identification Mission, 1992. (Annex 4 - 'Health systems in Ghana: structure and function').

DFID (ODA) (1995) *Britain and Ghana - partners in development* - PR brochure

DFID (ODA)/MoH (1997) *Ghana Health Sector Assistance Programme. Output-to-purpose Review*, 20-31 January 1997

European Union (1995) *Co-operation between Ghana and the European Union. Annual Report 1995*

European Union (Van der Veen F.) (1995) AIDS TASK FORCE - EAC (European Association for Co-operation) 'Report on Mission to Ghana' 1995.

Ghana Nurses and Midwives Council (1993) Annual Report 1993.

Ghana Social Marketing Foundation (GSMF) (1996) *This is GSMF*, Accra, 1996.

Ghana Social Marketing Foundation (GSMF) *Marketing Plan 1996-98*, 1996.

GTZ (1993) report on project to 'Improve Primary Health Care in Northern Ghana' (GTZ project # P.N. 81.2020.6)

- GTZ (1995) *AIDS Control in Developing Countries - Ghana programme* (GTZ project # P.N. 87.2235.7) 1990-2000.
- GTZ (1995) *Responding to AIDS in the developing world: The GTZ contribution*
- Health Courier (1995-7) Journal for Ghana Medical profession. Volumes:
 4.6 feb-mar 1995
 5.5 dec-jan 1996
 5.6 feb-mar 1996
 6.2 jun-jul 1996
 6.4 oct-nov 1996
 6.5 dec-jan 1997
 7.1 apr/may 1997
 7.2 jun/jul 1997
- International Family Health (IFH) (1996) *Strategic Review of the Reproductive Health Sector in Ghana*, Sexual Health Consultancy, November 1996.
- IPPF (1989) *Review of Projects* Annexe 1.1 'Review of Selected Projects in Ghana'
- PPAG (1995) Draft Proposal of PPAG submitted to IPPF sexual health Programme:
 'Comparison of 2 approaches to the promotion of safer sex in the communities served by CBD agents, a family planning clinic and field workers.'
- Save the Children Fund (SCF-UK) (1995) *Field Directors Annual Report: Ghana Country Programme 1995*
- SCF (Rose) (1995) *Family and Reproductive Health Appraisal Study Report, 1995*.
- SCF (1996) *Projects supported under the Family and Reproductive Health Programme, 1996*.
- UNAIDS (1996) *Response to the HIV/AIDS Epidemic in Ghana, 1996*.
- UNAIDS (1997) Joint United Nations Programme on HIV/AIDS, Strategic Plan 1997-2000, Ghana.
- UNAIDS/WHO (1997) *District Response Initiative on HIV/AIDS Ghana case study draft report, 1997*.
- UNDP (1994) African Network on Ethics, Law and HIV, Dakar Declaration, 1 July 1994.
- UNFPA (1988) UNFPA-Ghana project, report on 2-day conference of Information Network Sub-Committee on Population/FLE and Communication Activities in Ghana, 21-2 September, 1988.
- UNFPA (1995) GoG/UNFPA Third Country Programme 1996-2000
- UNFPA (1997) Final Tripartite Review Meeting, Strengthening MCH/FP services in Ghana project GHA/94/PO4, 24th February 1997. Executive summary and summary of findings.
- UNICEF (1993) Family and Community Care Technical Support Group: Report of 1st TSG meeting, Ghana, October 1993.

UNICEF (1995) *Ghana Programme 2000*, 1995.

UNICEF (1995-6) *Master Plan of Operations and Programme Plans of Operation 1996-2000*, GoG/UNICEF.

UNICEF (1996) *HIV/AIDS Prevention and Care Activities in Ghana, October 1996*.

USAID (1994a) *Ghana Population and AIDS Program - Briefing Document*

USAID (1994b) GHANAPA Project Document, 1994.

USAID (1995) Ghana Family Planning and Health Project: Final Evaluation. Briefing Notes.

USAID (1996) Draft terms of reference for the training sub-committee of the Population and AIDS co-ordinating committee of the GHANAPA project.

World Bank (1993) *Ghana 2000 and Beyond: Setting the stage for accelerated growth and poverty reduction* Africa regional office, WAF report, February 1993.

World Bank (1997) *Staff Appraisal Report, Republic of Ghana, Health Sector Support Programme* Human Development III, Ghana Country Department, Africa Region, June 16, 1997.

WHO (1995) Ghana Annual Report, 1995.

5) National Health and Population Surveys and research reports (by institution)

Ghana Statistical Service

Ghana Demographic and Health Survey (GDHS) (1988), Ghana Statistical Service, Accra, 1990.

Ghana Demographic and Health Survey (GDHS) (1993), Ghana Statistical Service, Accra, 1994.

GSS (Ghana Statistical Survey)/USAID/Population Council (1994) *A situation analysis of FP service delivery points in Ghana*, March 1994.

GSS (Ghana Statistical Survey)/USAID/Population Council (1996) *A situation analysis of FP service delivery points in Ghana*, 1996.

GSS (Ghana Statistical Services) (1993) *Rural Communities in Ghana*, Report of national rural community survey as part of the 3rd round of Ghana Living Standards Survey, 1991-2.

GSS (Ghana Statistical Services) (1995) *The Pattern of Poverty in Ghana 1988-1992*, Chapter 8 'Health', Study based on Ghana Living Standards Survey, November 1995.

MoH Research Reports

Owusu G and Ablordey M (undated) *Community perspectives, participation and sustainability in health care programmes*, report for Save the Children Fund.

- GMoH, HRU (1992) *Conception and Misconceptions*, Community views on FP, Health Research Unit, Accra, August 1992.
- Richardson et al (1992) *Should the Nurses be Blamed?*, Ghana Medical School/MoH, Accra, 1992.
- Dovelo D et al (1992) *What does the Public Want from Us?* Study of user satisfaction with services in government health facilities in Eastern Region, Ghana. April 1992.
- MoH (1993) 'Village based surveillance system for the northern region, Ghana. Research Proposal, 1993.
- USAID (1994) Ghana National FP Programme - Strengthening Contraceptive Logistics Systems 1994-2005 (FP Logistics Management Project)
- Odoi-Agyarko H et al (1995) 'Improving and Expanding Contraceptive Services, December 1995.
- MCH/JHPIEGO (1996) Needs assessment for Integration of STD and FP services, Eastern Region, Ghana, July 22 - August 6 1996.

Navrongo Research Papers

- Population Council (1993) Operations Research Project in Navrongo, Ghana. Proposal outlining Phase 1 of Navrongo Community Health and FP Project.
- Binka F et al (1994) 'The Navrongo Community Health and Family Planning Project' Paper presented at the Health Research Unit 3rd Consultative meeting on Health Research development, MoH, Accra, January 13-14 1994.
- Nazzar A et al (1995) 'Involving a traditional community in strategic planning: The Navrongo Community Health and FP Project Pilot Study', paper presented at annual meeting of Population Association of America, San Francisco, April 6-8, 1995.
- Population Council (1996) 'Findings from Phase 1 of the NCHFP project' *Update* 5 May 1996.
- GMoH/WHO-UNICEF (1996) Dissemination seminar on CHFPP project, Navrongo Health Research Centre, Accra, 7th August 1996. Proceedings and my notes.
- Fayorsey C et al (1994) 'The socio-cultural context of reproduction and FP among the Kassena-Nankana', CHFPP Documentation Note Number 10, August 1994.
- Antwi-Nsiah C et al (1995) 'Community reactions to the Community Health and FP Project', CHFPP Documentation Note Number 23, May 1995.
- Ngom P et al (1995) 'Report on the Community Health and Family Planning Project Survey of Husband and Wives' CHFPP Documentation Note Number 28, December 1995.

6) Conference/workshop reports and proceedings (by subject)

Reproductive health

- First National Consultative Meeting on Safe Motherhood (1993)

Second National Consultative Meeting on Safe Motherhood (1994)

GMoH (1993) Report of Regional Directors' Conference 'Improving coverage and quality of health care: the case of maternal and child health services', Accra, January 1993.

Adolescent Reproductive Health Summit, September 16, 1996, Accra. Papers from conference and draft policy guidelines.

STDs and AIDS

NACP, MoH (1993) Training of trainers Workshop on STD management, Mumasi 6-10 September 1993.

Third National Seminars on AIDS, MoH, Accra, 1993

Fourth National Seminars on AIDS, MoH, Accra, 1994

Population

GoG (1991) Ghana Population Policy: Future Challenges. Report of the 1989 National Population Conference.

NCP (1996) Report of Workshop on Decentralising the Operations of the NCP, Accra, September 10-12, 1996.

Policy, management and training issues

Akosombo Health Policy Seminar (1992) 'Review of 1991 and Directions for 1992, 13-17 January 1992.

GMoH (1992) Consultative workshop on cash and carry, 1992.

MoH (1994) 'Improving Health Management at District and Sub-District levels', Annual Conference of District Medical Officers, Kumasi, April 1994.

MoH HRDD (1996) 'WHO projection models, Human Resources for Health' Report on Meeting for Policy Makers, 20-23 March 1996.

Ashanti Regional Health Administration (1996) Report on Training of Trainers workshop for subdistrict staff on the formation of Village Health Committees, Kumasi, 6 May-15 June, 1996.

GMoH Policy Guidelines for Strengthening Research to Support the Medium Term Health Strategy in Accra, Ghana, May 1997. Workshop Report.

7) Media

USIS (US Information Service) (1997) *Significant Media in Accra*, March 1997.

Newspaper articles from all leading newspapers in Accra and the Upper East Region, 1996-7:

Daily Graphic (daily)

Independent (2X/week)

Ghanaian Chronicle (weekly)

Public Agenda (weekly) (UER)

APPENDIX 4

Appendix 4 Topic Checklist for Key Informant Interviews

Questions for MoH personnel

It should be stressed that this 'topic checklist' is not an interview schedule, the questions were treated in a highly flexible way and varied according to what the researcher felt was needed from each interviewee. Several key respondents were interviewed more than once.

*Processes of policy making (procedures, hierarchies and influences):

- What are the stages a policy on reproductive health has to go through before it is legislated on? What is the relative importance of each stage? Who influences each stage?
- In your opinion are these procedures problematic? - do they often break down, if so at what point and why?
- Which individuals and/or organisations, both within and outside the MoH, have an influence on policy decisions concerning reproductive health? What are their relative influences and how are they manifested (pledges to give funds/threats to withdraw support etc.)?
- Would you say there is a hierarchy of influence in policy decision making? In what way/how is it evidenced?
- Are there others who would informally contact you or other policy makers?
- Are there others whom you would wish to contact or you think should be contacted (formally or informally)? How would such contact be made?
- Are there any co-ordination mechanisms for managing resources input from different donors and NGOs? If not, is this problematic? If so, are they effective?

*FP/STD policies and personal opinions

- What is the official consensus on what MCH/FP and STD/HIV care should be including?
- What are the general aims of the current MCH/FP policies and who are they aimed at? (policy meanings and goals).
- What is your opinion of these current policies? Do you consider them to have been successful/failures/ problematic/obsolete etc.? Why?
- What are the general aims of the current STD/AIDS policies and who are they aimed at? (policy meanings and goals).
- What is your opinion of these current policies? Do you consider them to have been successful/failures/ problematic/obsolete etc.? Why?

*Opinions of Integrated services

- What is your opinion of a potentially integrated reproductive health policy?
- Why do you think there should/should not be an integrated programme in the near future (i.e. rationale for integration)?
- Who else is likely to share your opinion?
- What are the likely implications of funding and resource flows etc.?
- In your view is the current MoH capacity adequate to support an integrated programme? What changes might need to be implemented?
- Would the NGO/mission and the private-for-profit sectors be involved? - Should they be? What would their role be?
- Are there any mechanisms currently in place for reviewing the possibility of formal integration?
- If so, who initiated them, with what support/opposition and why?

Questions for non-MoH personnel:

*Roles and mechanisms of influence on MoH Policy

- How do you contribute to or influence formulation of reproductive health policies in Ghana?
- How is your influence manifested? - financial, technical, human resources, medical resources, and support flows etc.
- Does your support differ at different levels (i.e. Regional, District, Sub-district)? How?
- Do you have formal links with the MoH? If so, how are these maintained? If not, what are your channels of communication and influence?
- Are there any formal (or informal) mechanisms for co-ordinating resources input from different donors and NGOs? If not, is this problematic? If so, are they effective?

*Reproductive health services: Opinions and Support Potential

- What is your organisation's own policy on provision of reproductive health services (in particular MCH/FP and STD/HIV)?
- What services do you currently support? (and in what ways - financial; resources etc.)

- What is your opinion of these services? - Are they adequate? Do they face any constraints?
- Do the services you support include any level of 'integrated reproductive health services'? (in terms of combinations of MCH/FP and STD/HIV services).
- What, in your opinion, should reproductive health services cover?
- Do you think the provision of such 'integrated' services is feasible in Ghana?
- What is your opinion of MoH MCH/FP and STD/HIV services?
- If the MoH integrated STD/HIV services into MCH/FP facilities, would you support them?
- If so, in what ways would you be able to do this?
- If not, why?

These questions were adapted in the field for interviews with administrative /management personnel at regional and district levels to ascertain hierarchies, influences and mandates of the MoH and NGO senior personnel, and their inter-relations, which affect policy implementation at each level.

In addition, the following questions were asked:

- Are there official directives/guidelines on implementation?
- What is the role of decentralisation in implementing policies at this level, in terms of resource flows, controls etc.?
- Has decentralisation, in your opinion, been an effective mechanism for implementing reproductive health policies? Why/why not?
- What are the levels of authority in reproductive health policies?
- Are there any co-ordination mechanisms at this level for managing resources from different donors and NGOs? What? Do they work?
- Who provides MCH/FP and STD/HIV services at this level?
- What do they provide?

APPENDIX 5

Appendix 5 Observation checklist for facility visits

Because of the extensive Ghana Statistical Service/USAID/Population Council Situation Analysis which were carried out at health centres and FP units throughout the country in 1994 and 1996, the facility checklist used here were basic and did not cover clinical equipment.

Clean Water Supply

Electricity supply or kerosene fridge (for vaccines etc.)

Client toilet/urinal

Private consulting room

Examination Couch

General clinic Cleanliness

Posters and other IE&C material

APPENDIX 6

Appendix 6 Interview checklist for semi-structured clinic staff interviews.

I Introduction

“We are conducting research into services available in this district which are providing reproductive health care. By reproductive health care, we mean services which meet needs for management of HIV and other sexually transmitted diseases as well as those for family planning and other aspects of MCH. We are particularly interested in services for women of reproductive age but would also like to know about services for men or younger women where they are provided.

All information you give us will be treated confidentially. We are from the London School of Hygiene and Tropical Medicine which is an independent university. The Ministry of Health has approved this research, but we are not working for the Ministry of Health.”

II Training and experience

Staff grade

Where were you trained?

What does your job involve?

What was the date and duration of your last training? What did it cover? Who organised and paid for it? Where was it held?

How long have you worked as [grade]?

How long have you worked at this institution?

Where did you work before that?

Have you ever received training on STDs or HIV/AIDS?

If so, what did it cover? [prompt: ICE, counselling, recognition of symptoms, when to refer, use of syndromic management flowcharts?, other]

now I want to ask you some questions on FP and MCH care

III Family Planning Providers

What details do you take during a family planning consultation? [obtain a copy of form used and use details below as prompt]:

- personal history
- medical history
- sexual history
- menstrual history
- obs and gyny history

Do you perform physical examinations?

On which clients (IUDs users; new users?)

Do you perform any of the following - if so, on which clients:

- genital inspections
- speculum examinations
- pelvic examinations
- bi-manual pelvic exams
- pap smears

Which contraceptives do you offer here and what are the charges?:

condom, injectable, pill, IUD, surgical, spermicide creams, sponge, diaphragm

Do you have a condom demonstrator?

Do many people use condoms?

Do you ever talk to clients about using condoms?

Are there ever any problems getting contraceptives? Why?

Do you give IEC? - what materials do you use? (posters, flipcharts)

Is it individual or in a group?

What does it cover? - FP methods; STD/HIV: signs, prevention, treatment/where to go?

IV Ante-Natal Care providers

What patient details are taken? (as for FP)

What would you do if a woman complained of pain/difficulty in urination or of discharge or itching? (e.g.: examine, treat with antibiotics, refer)

What examinations do you do? Prompt:

- general exam
- physical (describe)
- obstetric
- vaginal: manual, speculum, pelvic, bi-manual?

If there is discharge or ulceration, what would you do?

If swab is taken, ask where it is sent Are there culture and transport media on site? If not, where from?

Do you do lab investigations? Which ones and where are they done (here or referred - to where?)

- urine tests (specify)
- blood tests (Hb, FBC, WBC, HIV, VDRL, other)
- any other tests

Is IEC given? - one-to-one or in a group

What does it cover? (Probe: FP; HIV/STD?)

Do you have any links with TBAs or CHWs?

Do TBAs ever refer women to you?

What do you think about routine screening for gonorrhoea, HIV and other STDs as well as syphilis?

Do you think women coming for ANC would be willing to have counselling/education on STDs/HIV? Would they be willing to be examined and treated? If not, why?

Do you think routine screening for STDs should be done for ANC clients?

Do you think routine screening for HIV should be done for ANC clients?

V Post-Natal Care /Child Welfare Clinic providers

When a client comes for the first time, what do you do?

- history taken
- general exam
- specific exam

In any of these do you ask about discharge or genital sores?

Do you take lab tests? (specify)

Are lab tests routinely done/offered?

If a child is brought with eye discharge, what would you do? (refer, treat child, treat mother, counsel on STDs?)

Do you give IEC?

What does it cover (specify details and materials used)

- birth spacing
- anything on STD/HIV e.g.: keeping to one partner/signs, dangers, prevention etc.

Do you think women coming for PNC would be willing to listen to counselling/education on STDs/HIV/AIDS? If not, why?

Would they be willing to be examined and treated? If not, why?

Do women ever ask you about birth spacing or reproductive (female) health? If so, what would you do? (counsel, advise, refer?)

VI Disease Control/Out-Patients Department

Do you see any STD/HIV cases here?

Do they come straight to disease control or are they referred from elsewhere? If referred, where from/by who?

Do you give IEC on STD/HIV prevention? What does it cover (condom use, partner treatment etc.)?

How do you manage STDs/HIV? Treat by syndromes/symptoms or lab tests?

If syndromes, specify main treatments for:

- vaginal discharge
- urethral discharge
- ulcers
- other

If lab tests are done, which? Where (here or sent elsewhere)?

VDRL (Syphilis)

RPR (Syphilis)

TPHA (Syphilis)

Urine RE (UT infection)

Urine C/S (vulval vaginitis)

HSV (herpes)

ELISA (chlamydia)

HEP B

Vaginal swab

Urethral swab

Gram stains (Gon)

Wet prep (Gon)

GC culture and sensitivity (Gon)

HIV serology

What is your opinion of integrating STD surveillance and management into MCH/FP activities at this facility?

VIII Opinions

Are there any guidelines here (government, hospital, other) on how to treat and manage STDs?

Have you seen the MoH syndromic flowcharts? Is there a copy here?

Have you seen the safe motherhood guidelines? Is there a copy here?

How would you feel if you were asked to include more education to clients on STD/HIV? Would clients be willing to listen?

How would you feel if you were asked to diagnose and refer or treat STDs?

Are there any aspects of STD or HIV management you think would be difficult or that you personally would not want to do? (e.g.: physical exams; problem of drug supplies; expense of lab tests etc.)

What do you think of providing integrated services? (that is, being able to screen for STDs when clients come for other things)

What, in your opinion, needs to be done to improve STD management and treatment?

Do you think there is a stigma attached to STDs? to AIDS?

Would it affect people's use of the clinic if they knew you gave talks and treatment for STDs and AIDS here?

IX for Medical Assistants or In-Charges

Are condoms available here? From who (FP nurse, OPD staff, in-charge?)
Who can get them?

Are there ever any problems in supply? What? Why?

Do you ever take swabs?

- urethral

- vaginal

Is there culture media available here? Is there transport media available here?
Where are the swabs analysed?

Is there any sterilising equipment here? What (chemicals, boiling water)?

Do you ever use any of the following drugs:

Tetracycline

Metronidazole

Benzathine penicillin

Procaine penicillin

Doxycycline

Erythromycin
Amoxicillin
Ampicillin
Septrin
Nalidixic acid
Ceftriaxone
Ciprofloxacin
Canesten
Nystatin
Gyno-Daktarin
Gyno-pevaryl
Chloramphenicol

Is there a cold store facility here?

Are there any guidelines (from government, hospital, other) here on use and prescription of these drugs? (e.g.: EDL)

X Senior person in-charge

Are supplies of contraceptives and of STD drugs readily available here?
If shortages are experienced, when and why? How frequently do they occur?

Where do hospital resources and funds come from? How are they obtained? Who is the clinic accountable/responsible to for these funds?
If donors give resources, specify what.

Do you get much IEC material (from MoH or anywhere else?) What does it cover? (FP, STDs etc.).

What are the relationships between management staff at his hospital and district/regional administration?

Are there any directives/guidelines regulating hospital policy on MCH/FP and STD/HIV management? If so, what do they cover?

In your opinion, could any STD/HIV services, at any level, be included in the current work of this clinic? If so, what? What would it entail in terms of operations and workloads?

How integrated would you say MCH activities are at this facility?

Questions for hospital managers

Availability of Supplies/Source of resources

- What contraceptives and STD drugs are available at this hospital?
- Are supplies reliable and readily available? If shortages are experienced, why? Where does the supply line break down? How frequently does this occur?
- Where do hospital funds and resources come from?

- How are resources allocated?

Hierarchies and Operational directives

- What is the relationship between management staff at this hospital and District/regional level administrators of reproductive health policies?
- What is the authority of each level?
- Are there any directives/guidelines regulating hospital policy on MCH/FP and STD/HIV management?
- If so what do they cover?
- In your opinion, could any STD/HIV services, at any level, be included in the current work of this clinic? If so what and how? What would it entail in terms of changing operations/workloads etc.?

APPENDIX 7

Appendix 7

Key policy documents and their content

Policy/Guideline	Date Introduced	Main Tenets and Implications for Reproductive Health
Health Service and Management Act 525	1996	<ul style="list-style-type: none"> • Creates a policy-executive split establishing the Ghana Health service as an executive agency separate from MoH HQs. • Establishes 2 autonomous teaching hospital boards. • The Ghana Health Service Council is the main governing body, accountable to Parliament through the Minister of Health. • Employees will no longer be part of the civil service, though the MoH itself is and remains responsible for formulation of sector policies. May be easier to expand staff mandates (job descriptions) for more integrated services.
Medium Term Health Strategy	1995-2000	<ul style="list-style-type: none"> • 3 areas for service delivery: PH, Clinical services, maternity services • 5 levels for implementation: community, sub-district, district, region, national. • Technical Guidelines set out strategies for treatment - NACP's 2 main objectives are: 1) prevent HIV infection 2) reduce impact HIV/AIDS. No specified STD component in 1995/6 guidelines. • Does not detail how logistic support is to be organised.
Health Sector 5 year Programme of Work	1995-2000	<ul style="list-style-type: none"> • STD management is specified as a priority health intervention area under both 'Health, Protection and promotion' and 'Management of selected endemic diseases'. • The RH programme is specified as a separate area covering 'FP services; Essential and emergency obstetric care'. (p11). • 7 areas make up the minimum package of health services that should be available at all health centres.
National Population Policy	1994 (revised edition)	<ul style="list-style-type: none"> • NCP established as a co-ordinating and advisory body on all population activities. • located in Office of the President. • Main donors are UNFPA and USAID • Action Plans state MCH should promote RH and sexual health. Under FP there is no mention of management of sexual health, RTIs etc. MCH policies and programmes are seen as integral parts of health care. • NCP Action Plans, Vol. on MCH/FP p.2. ARH and STDs/HIV are specifically spelt out as activity/programme areas. STD treatment is also included under some of the sub-themes.

Appendix 7 cont.

Policy/Guideline	Date Introduced	Main Tenets and Implications for Reproductive Health
Reproductive Health Policy and Standards	1996	<ul style="list-style-type: none"> • The section on 'STD Management' sets out what ideal STD management should cover at each of the 5 levels, from syndromic management to laboratory diagnosis. • STD screening and prevention is also mentioned under ANC and FP sections. • No indications of what strategies might effect the implementation of these policies.
Safe Motherhood Guidelines (MCH/UNICEF)	1994	<ul style="list-style-type: none"> • Detail activities and treatment regimes for MCH staff at level A, B and C institutions. • No mention of syndromic diagnosis; for level B (health centre/community clinic) tableted diagnosis is laboratory (requiring swabs and vaginal examinations). • Recommended treatments include the new gonorrhoea recommended drugs as well as general broad-spectrum antibiotics.
STD Management Guidelines	1996	<ul style="list-style-type: none"> • Provide diagnosis and treatment flowcharts for all major STDs by symptom. • Based on WHO charts. Easy to use, intended for use by nurses and practitioners at district and sub-district levels.
HIV/AIDS Management Guidelines	1992	<ul style="list-style-type: none"> • Diagnosis and care of AIDS patients at regional, district and sub-district levels.
Forthcoming HIV/AIDS management policy	In daft since 1994; yet to be finalised	<ul style="list-style-type: none"> • Medium term plans for management of HIV/AIDS at all levels.

APPENDIX 8

Appendix 8 Ranks and duties of Staff Cadres in the Ministry of Health

Table A Clinical Cadres

Category	Level of practice	Training	Responsibilities
District Director of Health Services (DDHS)	District level Often in-charge of the district hospital	Usually full medical training for MD (5+2 years).	Mainly administrative planning, management and decision-making at the district level. May undertake clinical duties at the district hospital.
Medical Assistants (MA)	District and sub-district health facilities.	Two-year training in medicine	Responsible for OPD services. At the sub-district level, they are often the officers in charge as well as head of the Sub-district Health Management Team.
Midwives (MW)	District and sub-district facilities.	Different levels of training: * Straight midwives (SM) trained only in midwifery * Enrolled Nurse midwives (ENM) who have midwifery training in addition to the basic nursing training * State Registered Nurse midwives (SRNM) who have a higher nursing training than the ENM.	These nurses are responsible for clinical aspects of maternity services, i.e. ante-natal, delivery and postnatal services and are also responsible for maternal services where there are no medical officers.
State Registered Nurses (SRN)	District and sub-district facilities.	Two years clinical nursing training, after which they can specialise in midwifery and public health nursing	Responsible for clinical aspects of out-patients and some ante-natal and post-natal services where a midwife is not needed.

Table B Public Health Cadres

Category	Level of practice	Training	Responsibilities
Public Health Nurses (PHN)	Usually based at the District Health Management level or at the district hospital.	SRN training followed by a 2-year midwifery training in addition to one and half years of special public health training.	They are in charge of the public health components of reproductive health: immunisation activities for pregnant women and infants; carry out child welfare; school health; Family Planning; home visits and health education duties.
Community Health Nurses (CHNs)	Sub-district facilities	Two categories: * Community Health Nurse midwives (CHNM) who have a lower basic nursing training than the SRN * Community Health Nurses (CHN) who have a basic two year non-clinical training.	These cadres perform the public health aspect of MCH/FP services: CHNMs perform basically the same duties as the PHN. CHNs perform all public health duties excluding IUD insertion and clinical maternity services.
Nutrition Officers and Communicable Disease Control (CDC) Officers	District	18 months training at Kintampo medical school	Work hand in hand with the district MCH/FP unit. * Nutrition officers normally support MCH/FP services during health talks * CDC (previously leprosy) officers take care of immunisation vaccines and support public health nurses during child welfare clinics.

APPENDIX 9

Appendix 9 Laboratory tests available in Upper East Region 1997

Test	Bolgatanga Regional Hospital, Bolgatanga District	Navrongo District Hospital, Kassena-Nankana District	Bawku District Hospital Bawku East District	Widana health centre, Bawku East District	Wiaga Catholic Mission Hospital Builsa District	Odoi's Private clinic, Bolgatanga District	Welfare Medical Laboratory (private) Bolgatanga District
HIV serology	Y	Y	Y	-	-	Take sample and send to Regional hospital	Y
ELISA	Y	-	-	-	-	-	Y
VDRL	Y	-	Y	-	-	Take sample and send to regional hospital	Y
RPR	Y	-	-	-	-	-	-
TPHA	Y	-	-	-	-	-	Y
Urine RE	Y	Y	Y	Y	Y	Y	Y
Urine CS	Y	-	Y	-	Y	Y	Y
HSV	N	-	-	-	-	-	Y
Hep B	Y	Y	-	-	-	Y	Y
Vaginal swab	Y	Y	Y	Y	Y	Y	Y
Urethral swab	Y	Y	Y	Y	Y	Y	Y
Grams stain	Y	Y	Y	Y	Y	Y	Y
Wet mount	Y	Y	Y	Y	Y	Y	Y
GC culture / sensitivity	Y	-	Y	-	-	Y	Y

The health centre at Garu, Bawku East District also has a small lab on site capable of basic swab analysis. It has a lab man who comes each market day (every three days). Builsa District Hospital, at Sandema, has a lab but it is not currently in operation, through lack of personnel. All do general blood tests - Hb, wbc, fbc etc.

APPENDIX 10

Appendix 10

STD Drugs included on the Essential Drugs List and in WHO/GoG STD algorithms; facility level classifications

Appendix 10a

Essential Drug List - Categories for Drug Delivery (ref. p.xiii Essential Drugs List 1996)

Level A - Community Health Clinic run by a Community Health Worker or a Village Health Worker

Level B1 - Health Centre without a Doctor, run by Medical Assistants

Level B2 - Health Centre with a Doctor

Level C - District hospital

Level D - Regional/Teaching hospital

Level SP - Specialist Drugs - for specialist use primarily in teaching and regional hospitals. They have to be requested from the Chief Pharmacist of MoH

Level PD - Programme Drugs - used in special programmes of the MoH. Their use usually spans all levels of care.

PD programmes include FP, AIDS control and TB.

Appendix 10b

STD Drug Classifications as specified in the Revised Essential Drugs List, 1996.

Drug Type and Name	Level of care
Penicillins:	
Amoxicillin caps 250mg	B2
Procaine penicillin inj 4mu	B1
Other Anti-bacterial Drugs:	
Ceftriaxzone inj 250mg	PD
Ciprofloxacin Tab 500mg	PD
Doxycycline caps 100mg	PD
Erythromycin tab 250mg	C
Nalidixic Acid tab 500mg	B2
Tetracycline caps 250mg	B1
Antifungal Drugs:	
Nystatin tab 500 000 IU	C
Metronidazole tab 200mg	B1
Clotrimazole tab 400+80	B1

APPENDIX 11

**PAGE
MISSING
IN
ORIGINAL**

Appendix 12 Policy discussion foras

Table A Multi-Party Meetings

Meeting	Agenda	Participants
'Health partners meeting': 1/month	Information sharing on activities within the health sector.	chaired by MoH MoH Unit heads/ reps, all donors working in the health sector some NGOs (Ghana - based) at the discretion of the GoG / donors (currently discussions underway on whether all NGOs should be routinely invited or invited on a rotational basis given their numbers and ambivalent relations between MoH and NGOs)
PACC (Population and AIDS Co-ordination Committee) for USAID Country Programme Partners Technical cmte meets monthly Policy Cmte theoretically meets 4/year	Feedback from agencies implementing the GHANAPA agreement (USAID). Monitoring the programme. Number of sub-cmtes including one on training chaired by MoH.	Chair: NCP USAID reps, all implementing agencies including MoH (unit/programme heads), PPAG, GSMF,
Donor - MoH meeting 2/year (in practice only 1/year)	Information sharing	MoH Unit heads All health Donors
UNFPA Annual Tripartite meetings for Third Country Programme	Feedback and monitoring for UNFPA's Third Country Programme	Chaired by government (MoH) UNFPA implementing agencies including PPAG,
Population Donors meeting meant to be organised by UNFPA 4/year but has so far only met twice and seems to have folded up	Information sharing	All donors in Population
NCP Technical Committee meetings. 1/month	Feedback and discussion of population issues and related topics for each of which there is a separate committee.	NCP, MoH reps, other committee members draw from the various organisations active in the field. (excluding donors)

Appendix 12 cont.

Table A cont.

Meeting	Agenda	Participants
Bilateral meetings MoH with USAID, UNFPA and ODA Regular ad hoc	Matters arising	MoH and USAID MoH and UNFPA MoH and ODA
Bilateral meetings: MoH and other donors. Irregular, as needed	Matters arising	MoH and all other donors in the health sector
Bilateral meetings: MoH Unit and Programme Directors with funding agencies as necessary	Matters arising regarding MoH implementation of specifically funded programmes	NACP and its funding agencies (donors/NGOs) MCH and its funding agencies (donors/NGOs)

Table B Internal MoH Meetings:

Meeting	Agenda	Participants
Director of Medical Services (DMS) and Minister for Health Weekly, or as necessary	Matters arising - policy and administration issues	DMS Minister for Health
Deputy Ministers and Minister for Health Weekly, or as necessary	Matters Arising	DMS Deputy Ministers
Division Directors Meeting	Matters Arising - policy and administration issues	DMS All Division Directors (6)
Unit/Programme Heads 1/4	Matters Arising - administration and service issues	Division Director All Unit and Programme heads
Unit Meetings 1/month	Matter Arising Programme Issues	Unit Head Senior unit and programme personnel

APPENDIX 13

Appendix 13 Table A National NGOs and religious organisations working in Health in Ghana

NGO	Remit	Area of Operation	Partners/ networks	Stance on integrated services
PPAG	runs MCH/FP clinics, produces FP IEC material, involved in GHANAPA and UNFPA 3rd Country Programme.	Nation-wide Primarily urban except the CBD (contraceptive outreach) programme	IPPF (contribute 780% funds) USAID (fund CBD programme) UNFPA (co-ordinates the 8 religious bodies who are implementing agencies under UNFPA TCP.) Collaborates with MoH, MoEd, NCS, CCG, NCWD in development of family life education material for schools and colleges	No integrated STD/HIV activities in its clinics. Director very pro-integration, but doesn't want to cause conflict.
Ghana Red Cross	Distribute non-clinical contraceptives and give FP IEC Adolescent health - has produced innovative games to increase STD/HIV awareness	Nation-wide	Other international Red Cross Societies	-
Ghana Social Marketing Foundation, GSMF, (formerly DANAFCO, under MoH)	promotes FP undertaking advertising and information dissemination and contraceptive distribution.	Nation-wide, but predominantly urban	USAID (funds the foundation as an NGO)	Advocates condom use for both FP and STD/HIV prevention
National Council on Women and Development (NCWD)	co-ordination of NGOs working in women's development; FP messages 1989 launched trial of FP delivery in traditional market places	Nation-wide	USAID (market delivery of contraceptives)	-

Appendix 13 cont.

NGO	Remit	Area of Operation	Partners/ networks	Stance on integrated services
Thirty-First December Women's Movement (TFDWM)	Women's development activities, Organises workshops and IEC for FP messages female education on link between population and development (UNFPA funded)	Nation-wide	UNFPA (funds for female education on population issues)	N/A
Christian Health Association of Ghana (CHAG)	Umbrella organisation for mission/church run health facilities (35 hospitals and large number of maternity centres and clinics); provide IE&C materials on FP and STD/HIV	Nation-wide	MoH (supplies staff on secondment to registered CHAG clinics), Invited to national health policy seminars / workshops etc.	The organisation HQs are in favour of integration. Held a workshop on STD activities at different levels, funded by NACP
Christian Council of Ghana (CCG)	Supports some health facilities; Distributes contraceptives and holds seminars on FP issues	Nation-wide	UNFPA (provides contraceptives and money for seminars) Invited to national health policy seminars/ workshops etc. CHAG member Links with PPAG and MoH Some past assistance from Family Planning International	N/A
National Catholic Secretariat	Run a natural FP centre in Accra Run and support clinics which are registered under CHAG	Nation-wide (particularly active in the North of Ghana)	World Catholic Church partners	Reticent on contraceptive use, but generally conciliatory and hasn't vocally opposed STD/HIV or FP policies
Ahamadiya Muslim Mission	Runs some clinics	Nation-wide	Invited to national health policy seminars, Contacts with PPAG, UNFPA and NCP	Do not actively discourage contraception, but promote ethics and morality over condoms.

Appendix 13 cont.

NGO	Remit	Area of Operation	Partners/ networks	Stance on integrated services
YMCA and YWCA	promote messages on FP and STDs/HIV to youth (through lectures, films etc.) Provide non-clinical contraceptives	Nation-wide	Invited to national level policy seminars etc., Links with PPAG	Particularly active in promoting safe-sex related messages to youth
Ghanaian NGOs: ISODEC/ CENCOSAD etc.	work with international NGOs on variety of health and development projects	Localised	International NGOs, notably SCF	No voice at national level. Responsive to local needs and concerns.

Table B International NGOs working in Health in Ghana

NGO	Remit	Area of Operation	Links/ Partners	Attitudes to and Activities on Integration
Save the Children Fund - UK (SCF)	Work through local NGOs on various health and development projects. Beginning a reproductive health project	In the districts - in 9 regions	DFID - main funder (£1.9M in 1997) MoH - personal links, especially with MCH.	Pro-integration.
Action Aid	AIDS/HIV Health Agriculture and rural Development	Primarily in North of Ghana, HIV/AIDS project in UER	EU	Haven't seriously integrated STD activities into their HIV/AIDS package. No clear stance on integrating STD/HIV and FP/MCH activities
Care International	AIDS programme	Western region	SCF	Country Rep is interested in perceptions of STDs/HIV and marketing of messages.
World Vision International	Provision of safe water through sinking of bore holes	Rural regions, especially in the North	local community and church groups	STD/HIV messages are not within their current remit.

APPENDIX 14

Appendix 14 Academic and professional bodies

Organisation	Mandate/interests	links/partners	Stance on integration
School of Public Health, Legon	Yet to secure a niche in the health arena. Director sees a role for independent analytical work on health services an delivery Train some medical personnel	Tension between MoH and School PH which is perceived to be critical of MoH	Snr lecturers are pro- integrated reproductive health services and are cognisant of implementation issues
Population Impact Project	To do research and produce documents on the reproductive health situation in Ghana	UNFPA - funding University of Legon - PIP is situated in the Geography department	N/A
Ghana Nurse and Midwife Council (GNMWC)	Statutory body regulating nursing and midwifery practice	MoH - funds recurrent expenditure USAID, DFID, DANIDA, JHPIEGO all fund workshops etc.	Lip service to integrated services, but there is consensus that STD management must take place at the highest professional level. No moves to incorporate detailed STD management into training curricula; no workshops held on STD activities
Ghana Registered Nurses Association (GRNA)	Voice for professional registered nurses Holds seminars and workshops	MoH - personal links through the current president	President is pro-integration, though no specific efforts to date
Ghana Registered Midwives Association (GRMA)	Voice for public and private registered midwives Holds seminars and workshops on pertinent topics	Working links with MCH unit Solely funded by USAID Involved at national level policy meetings Involved in GHANAPA CBD programme To be involved in UNFPA's TCP	Lip-service to integration. Have held some national level seminars on STDs Won't go do anything without sanction of GNMWC
Institute of Journalism	Only training school for journalists in Ghana. Has a mandatory population course and senior options courses on health/population	UNFPA - sponsor the FP courses and extra-curricula seminars etc.	N/A

BIBLIOGRAPHY

- Aboagye-Kwarteng T. and Moodie R. (eds) (1995) *Community Action on HIV: A Resource Manual for HIV Prevention and Care*. AUSAID, Macfarlane Burnet Centre for Medical Research, International Health Unit, Fairfield, Australia.
- Adibo et al (1996) *How can research influence health policy?* an IHPP occasional paper, Washington DC
- Adibo M (1992) 'Review of 1991 and Directions for 1992', final report of *Akosombo Health Policy Seminar*, MoH, Akosombo, Ghana, 13-17 January, 1992.
- Adongo et al (1997) 'Cultural factors constraining the introduction of family planning among the Kassena-Nankana of Northern Ghana', *Social Science and Medicine* 45 (12): 1789-1804, Pergamon press
- Adongo P.B. et al (1998) 'The influence of traditional religion on fertility regulation among the Kassena-Nankana of northern Ghana' *Studies in Family Planning* 29(1):23-40
- Aidoo T.A (1982) 'Rural health under colonialism and neo-colonialism: a survey of the Ghanaian experience' *International Journal of Health Services* 12(4)
- AIDS ALERT (1993) 'Oral contraceptives may increase the risk of HIV transmission' *AIDS ALERT*, 8(9):142-144
- AIDS Analysis Africa (1993-4) - volumes from 1993-1994
- AIDS Captions, Family Health International 3(1), May, 1996
- Airhihenbuwa C.O. (1995) *Health and Culture: beyond the western paradigm*, Sage publishers, Calif - Thousand Oaks
- Akyeampong E. (1996) *Drink, power and Cultural Change. A social history of alcohol in Ghana, c.1800 to recent times*, Heinemann, Portsmouth, USA
- Anarfi J.K (1993) 'Sexuality, migration and AIDS in Ghana - socio-behavioural study' *Health Transition Review* 3(supplement):45-67
- Anarfi J.K and Awusabo-Asare K (1993) 'Experimental research on sexual networking in some selected areas of Ghana' *Health Transition Review* 3(supplement)
- Ankomah A. (1992) 'Premarital Sexual Relationships in Ghana in the Era of AIDS' *Health Policy and Planning*, 7(2):135-143
- Ankomah A. (1998) 'Condom use in sexual exchange relationships among young single adults in Ghana' *AIDS Education Preview* 10(4):303-316
- Ankrah E.M and Henry K (1994) 'Empowering women may help retard HIV' *Network* 15(2):20-21
- Ankrah E.M. (1991) 'AIDS and The Social Side of Health', *Social Science and Medicine* 32(9):967-980

Antwi-Nsiah C. et al (1995) 'Community reactions to the Community Health and FP Project', CHFPP Documentation Note Number 23, May 1995.

Aral S.O. and Peterman T.A. (1998) 'Do we know the effectiveness of behavioural interventions?' *Lancet Supplement* 351(suppl III):33-36

Asamoah-Baah A. (1997) *Health Systems Development from a Country Perspective: Challenges and Implications for WHO*, WHO, Geneva, April 1997

Asamoah-Odei E.J. et al (1990) 'AIDS in Ghana, 1986-1989 Epidemiological Aspects' *Ghana Medical Journal* 24(3):191-200

Asibuo S.K. and Adusei J (1992) *The role of District Assemblies in intersectoral collaboration for health promotion and development in Ghana*

Awusabo-Asare K et al (1993) 'Women's control over their sexuality and the spread of STDs and HIV/AIDS in Ghana' *Health Transition Review* 3(supplement):69-83

Ayee J. (1994) *An Anatomy of Public Policy Implementation*, Avebury, Aldershot

Ayee J (1996) 'The Measurement of Decentralisation: The Ghanaian Experience, 1988-1992' *African Affairs* 95:31-50

Banerji D. (1984) 'Can there be a Selective Primary Health Care?' Unpublished paper. Consultation on operational issues in the transition from vertical programmes toward integrated primary health care. New Delhi, 4-12 June, 1984.

Barker C. (1996) *The Health Care Policy Process*

Bastos dos Santos R. et al (1992) 'Reproductive tract Infections in Mozambique: A Case Study of Integrated Services' in *Reproductive Tract Infections* ed. Germain A et al, Plenum Press, New York

Baum F. (1995) 'Researching Public Health: behind the qualitative-quantitative methodological debate' *Social Science and Medicine* 40(4):459-468

Behets F.M. et al (1995) 'Management of vaginal discharge in women treated at a Jamaican sexually transmitted disease clinic: use of diagnostic algorithms versus laboratory testing' *Clinical Infectious Disease* 21(6):1450-5

Berman P. (1982) 'Selective Primary Health Care: is sufficient efficient?' *Social Science and Medicine* 16:1054

Bernhart M.H (1992) *Strategic Management of Population Programs*, World Bank Policy Research working paper 996, Population and Human Resources Department

Binka F. et al (1994) 'The Navrongo Community Health and Family Planning Project' Paper presented at the Health Research Unit 3rd Consultative meeting on Health Research development, MoH, Accra, January 13-14 1994

Blanc A.K and Lloyd C.B (1990) 'Women's Childbearing Strategies in Relation to Fertility and Employment in Ghana' The Population Council (Research Division) Working Paper no.16

- Boland R and Young M (1982) 'The strategy cost and progress of primary health care' *Bull Pan Am Org* 16(3):233
- Bosu W.K. et al (1998) 'The management of pelvic inflammatory disease in the Central region of Ghana is not standardised' *International Journal of STD AIDS* 9(7):408-13
- Bourgois A. et al (1996) 'Development and evaluation of screening algorithms for sexually transmitted diseases in pregnant women at Libreville, Gabon' (in French) *Sante* 6(2):115-121
- Bourgois A. et al (1998) 'Clinical algorithms for the screening of pregnant women for STDs in Libreville, Gabon: Which alternatives?' *Sexually Transmitted Infections* 74(1):35-9
- Brinkerhoff D.W (1996) 'Process perspectives on policy change: Highlighting Implementation' in *World Development* 24.9:1395-9
- Bradley D.J (1998) 'The particular and the general. Issues of specificity and verticality in the history of malaria control' *Parassitologia* 40:5-10
- Brown G.F. (1987) 'Family Planning Programmes' *Technology in Society*, 9:465-480
- Bruce J (1990) 'Fundamental Elements of the Quality of Care: A Simple Framework', *Studies in Family Planning*, 21(2):61-91
- Bruce J and Jain A (1991) 'Improving the Quality of Care through Operations Research', in: Seidman M and Horn M C (eds) *Operations Research: Helping Family Planning Programmes Work Better*:259-282.
- Brugha R. and Taylor E. (1998) 'The Implications of decentralisation for the delivery of disease control services: The case of TB' Report for WHO Global Programme on TB, Accra.
- Bryman A. (1988) *Quantity and Quality in Social Research*, London, Unwin Hyman
- Bryman A. and Burgess R.G. (1994) Developments in qualitative data analysis. In: *Analysing Qualitative Data*, edited by Bryman A. and Burgess R.G. Routledge:1-15.
- Bulatao R.A (1984) *Reducing Fertility in Developing Countries: A Review of Determinants and Policy Levers*, World Bank Staff Working Paper no.680
- Bulatao R.A (1995) *Key Indicators for Family Planning Projects*, World Bank Technical Paper no.297
- Burgess R.G. (1982) 'The Unstructured Interview as a Conversation.' In: *Field Research: A Sourcebook and Field Manual*, edited by Burgess R.G:107-110.
- Burgess R.G. (1984) 'Methods of field research 2: Interviews as conversations.' In: *In The Field*, Burgess R. (ed.):101-122.
- Butchart A. (1998) *The Anatomy of Power: European construction of the African Body*, London, Zed Press
- Caldwell J C (1982) *Theory of Fertility Decline*, London, Academic press
- Caldwell J.C (1983) 'Direct Economic Costs and Benefits of Children' in Bulatao R.A and Lee R.D (eds) *Determinants of Fertility in Developing Countries*:458-477.

- Caldwell J.C. (1990) 'High fertility in sub-saharan Africa' *Scientific American* 262(5):118-125.
- Caldwell J.C and Caldwell P (1987) 'The Cultural Context of High Fertility in Sub-Saharan Africa', *Population and Development Review*, 13(3):409-437
- Cassels A and Janovsky K (1992), 'A time of change: health policy, planning and organisation in Ghana' *Health Policy and Planning* 7(2):144-154
- Cassels A. and Janovsky K. (1996), 'Reform of the Health Sector in Ghana and Zambia: commonalities and contrasts' WHO internal document
- Cates W. and Stone K. (1992a) 'Family Planning: The responsibility to prevent both pregnancy and reproductive tract infections', *Reproductive Tract Infections* ed. Germaine et al. Plenum Press, New York
- Cates W. and Stone K. (1992b) 'Family Planning, Sexually Transmitted Diseases and Contraceptive Choice: A Literature Update - Part 1', *Family Planning Perspectives* 24 (2): 75-84.
- Cates W. and Stone K. (1992c) 'Family Planning, Sexually Transmitted Diseases and Contraceptive Choice: A Literature Update - Part 2', *Family Planning Perspectives* 24 (3): 122-128.
- Chibwana T (1993) 'Male Involvement: The Missing Dimension in Promoting Child Spacing' *Malawi Medical Journal* 9(1):18-30.
- Chonde T M 1989. 'The role of bacteriological services in the National Tuberculosis and Leprosy Programme in Tanzania' *Bulletin International Union Tuberculosis and Lung Disease* 64(3):37-39
- Chow et al (1996) 'Is urine leukocyte esterase test a useful screening method to predict trachomatis infection in women?' *Journal of Clinical Microbiology* 34(3):534-6.
- Chum H J (1991) 'The Tanzania National Tuberculosis/Leprosy Programme in the face of HIV infection', *Bulletin International Union Tuberculosis and Lung Disease* 66(sup):53-55
- CIDA (Mayhew and Avle; HRU) (1996) *Pharmacy Outlets Survey: STD management*, report prepared for CIDA
- Cleland J and Wilson C (1987) 'Demand Theories of Fertility Transition: An Iconoclastic View', *Population Studies*, 41(1):5-30
- Codjoe F.K. (1988) *Elites, Ideology and Development Problems of Ghana*, PhD Thesis, Hamburg University, Verlag an der Lottbek
- Correa S. (1997) 'From reproductive health to sexual rights: Achievements and future challenges' *Reproductive health matters* 10:107-116
- Creatsas G. (1997) 'Contraception and sexually transmitted diseases' *European Journal of Contraception and Reproductive Health Care* 2(4):259-62
- Crook R.C (1994) 'Four years of the Ghana District Assemblies in operation: decentralisation, democratisation and administrative performance' *Public Administration and Development* 14(4):339-364

- Crosby B.L (1996) 'Policy Implementation: The Organisational Challenge' in *World Development*, 24(9):1403-1415
- Crosby B.L (1997) 'Stakeholder analysis and political mapping: Tools for successfully implementing policy reforms' *Policy Studies and Developing Nations* 5:261-286
- Dallabetta G.A. et al (1993). 'High Socio-economic Status is a Risk Factor for Human Immunodeficiency Virus Type 1 (HIV-1) Infection but Not for Sexually transmitted Diseases in Women in Malawi: Implications for HIV-1 Control.' *Journal of Infectious Diseases* 167:36-42
- Danziger J.N. (1991) *Understanding the Political World*, Longman, New York
- Daly C.C. et al (1994) 'Risk factors for gonorrhoea, syphilis and trichomonas infections among women attending family planning clinics in Nairobi, Kenya' *Genitourin Medicine* 70(3):155-61
- De Lay P. (1994) 'Adding STD Services needs Careful Evaluation', *Network* 14(4):8-10
- Decosas J. (1995) 'Epidemic in Ghana: "a very distinct profile"' *AIDS Analysis Africa* 5(3):12
- Deniaud F. (1997) 'Dynamics of female condom acceptability among prostitutes and young women in Abidjan, Ivory Coast' *Contraception, Fertility and Sexuality* 25(12):921-32
- Diallo M.O. et al (1997) 'Sexually transmitted diseases and human immunodeficiency virus infections in women attending an antenatal clinic in Abidjan, Cote d'Ivoire' *International Journal STD AIDS* 8(10):636-8
- Dixon-Mueller R. and Wasserheit J. (1991). *Reproductive Tract Infections in Women in the Third World*. IWHC
- Dodd R. (1994) 'Quantifying the STD-HIV connection' *AIDS Analysis Africa* 4(5):16
- Dodd R. (1995) 'President Rawlings stays silent despite OAU challenge - "an absence of interest?"' *AIDS Analysis Africa* 5(6):13-14
- Dovelo D et al (1992) *What does the Public Want from Us?* Study of user satisfaction with services in government health facilities in Eastern Region, Ghana
- Easterlin R.A (1983) 'Modernisation and Fertility: A Critical Essay' in Bulatao R.A and Lee R.D (eds) *Determinants of Fertility in Developing Countries*
- Edwards S.R (1994) 'The role of men in contraceptive decision making: current knowledge and future implications', *Family Planning Perspectives* 26(2):77-82
- Elias C.J and Heise L.L (1994) 'Challenges for the development of female controlled vaginal microbicides', *AIDS* 8(1):1-9
- Enimayew N (1994) Value for Money: Some Efficiency issues in health services delivery in the Tano district of Ghana
- Evans et al (1981) 'Health Care in the developing World: Problems of Scarcity and Choice', *New England Journal of Medicine*, 305(19):1117

- Ezeh C.A (1993) 'The influence of spouses over each others' contraceptive attitudes in Ghana' *Studies in family planning* 24(3):163-173
- Family Health International (FHI) (1998) 'Beyond the Rhetoric: Improving Reproductive and Sexual Health in the Post-Cairo Era' Project proposal from Family Care International, Draft
- Fayorsey C et al (1994) 'The socio-cultural context of reproduction and FP among the Kassena-Nankana', CHFPP Documentation Note Number 10
- Field M.L (1996) *AIDS Captions* 3(1)
- Financial Times (1998) Special Survey on Ghana, 22 June, 1998.
- Finger W R (1994) 'Should Family Planing Include STD Services?' *Network* 14(4):4-7
- Finger W R and Barnett B 1994. 'Regional Perspectives', *Network* 14(4):22-25
- Finkle J. L and McIntosh C.A (eds) (1994) *The New Politics of Population*
- Foltz A (1995) *The Policy Process: Health research and development Priorities* Paper prepared for WHO working group on Health Research and Development Priorities: Health Policies and Systems, WHO
- Ford N. (1993) 'Consequences of Population Programmes on Quality of Life and Sustainable Development'
- Ford N. and Sporne C. Survey Interviewing and Key Informant Interviewing, Exeter University/IPS:1-25
- Forum (1991) 20:6-7, 1991.
- Fosu G.B. (1981) 'Disease classification in rural Ghana: framework and implications for health behaviour' *Social Science and Medicine* 15B: 471-482, Pergamon Press
- Foucault (1991) in Rabinow P. (ed) (1991) *The Foucault Reader: An introduction to Foucault's thought*, London, Penguin
- Fransen L. et al (1991) 'Health Policies for Controlling AIDS and STDs in Developing Countries' *Health policy and Planning* 6(2):148-156.
- Freedman R (1987) 'Fertility Determinants' in Cleland J and Scott C (eds) *The World Fertility Survey: An Assessment*:773-795.
- Gerbase A.C. et al (1998) 'Global epidemiology of sexually transmitted diseases' *Lancet supplement* 351 (suppl III):2-4
- Germain A et al (eds) (1992) *Reproductive Tract Infections: Global impact and priorities for women's reproductive health*, Plenum Press, New York
- Germain M. et al (1997) 'Evaluation of a screening algorithm for the diagnosis of genital infections with Neisseria gonorrhoea and Chlamydia trachomatis among female sexworkers in Benin' *Sexually Transmitted Diseases* 1997 24(2): 109-15

Gertig D.M. et al (1997) 'Risk factors for sexually transmitted diseases among women attending family planning clinics in Dar-es-Salaam, Tanzania' *Genitourin Medicine* 73(1):39-43

Ghana Demographic and Health Survey (GDHS) (1988), Ghana Statistical Service, Accra, 1990

Ghana Demographic and Health Survey (GDHS) (1993), Ghana Statistical Service, Accra, 1994

Ghana MoH (GMOH) (1991) AIDS Counselling manual, NACP, MoH, Accra

Ghana MoH (1992a) *Ministry of Health Annual Report 1991*, MoH, Accra

Ghana MoH (1992b) *Conception and Misconceptions: Community Views on Family Planning*, MoH, Health Research Unit, Accra

Ghana MoH (1992c) Proceedings from a 'Consultative workshop on cash and carry', MoH

Ghana MoH (1993a) *Ministry of Health Annual Report 1992*, MoH, Accra

Ghana MoH (1993b) 1992 Annual report, Epidemiology Division, MoH, Accra

Ghana MoH (1993c) *Policies and Priorities for the Health Sector 1994-1995* Draft Document, MoH, Accra

Ghana MoH (1994a) *Ministry of Health Annual Report 1993*, MoH, Accra

Ghana MoH (1994b) *Maternal and Child Health and Family Planning Annual Report 1993*, Technical co-ordination and Research division, MoH, Accra

Ghana MoH (1995a) *Ministry of Health Annual Report 1994*, MoH, Accra

Ghana MoH (1995b) *Maternal and Child Health and Family Planning Annual Report 1994*, Technical co-ordination and Research division, MoH, Accra

Ghana MoH (1995c) *HIV Sentinel Surveillance 1994*, Epidemiology Division, Disease Control Unit, MoH, Accra

Ghana MoH (1996a) *Maternal and Child Health and Family Planning Annual Report 1995*, Technical co-ordination and Research division, MoH, Accra

Ghana MoH (1996b) *HIV Sentinel Surveillance 1995*, Epidemiology Division, Disease Control Unit, MoH

Ghana MoH (1997) *HIV Sentinel Surveillance 1996*, Epidemiology Division, Disease Control Unit, MoH

Ghana MoH (UER) (1994) *Upper East Region Annual Report 1993*, UER RHMT

Ghana MoH (UER) (1995a) *Upper East Region Annual Report 1994*, UER RHMT

Ghana MoH (UER) (1995b) Regional Administration Data Base, RHMT, Bolgatanga

Ghana MoH (UER) (1995c) *Regional Hospital Annual Report 1995*, Bolgatanga

- Ghana MoH (UER) (1996a) *Upper East Region Annual Report 1995*, UER RHMT
- Ghana MoH (UER) (1996b) *Regional Hospital Annual Report 1996*, Bolgatanga
- Ghana MoH (UER) (1997) *Upper East Region Annual Report 1996 - Draft*, UER RHMT
- Ghana National Consultative Meeting on Safe Motherhood (1994) MCH Unit, MoH, Accra
- Gilks C.F. (1997) 'Tropical medicine in the HIV/AIDS era' *Lancet supplement* June 349 (suppl III):17-18
- Gilson L. (1997) The lessons of user fee experience in Africa, *Health Policy and Planning*, 12(4):273-285, Oxford University Press
- Gilson L. et al (1997) 'Cost effectiveness of improved STD treatment services as a preventive intervention against HIV in Mwanza Region, Tanzania' *Lancet* 350:1805-09
- Giorgis B.W. (1985) 'Health needs of rural women' Paper presented at *Conference of African Association of Rural Women for Research and development (AAWORD)*
- Government of Ghana (GoG) (1985) Criminal Code (Amendment) Law P.N.D.C.L. 102 (on abortion), Accra
- Government of Ghana (GoG) (1991) *Ghana Population Policy - Future Challenges: Report of National Population Conference*, Social Sector Policy Unit, Policy Analysis Division,
- Government of Ghana (GoG) (1992a) *Constitution of the Republic of Ghana* P.N.D.C.L. 282
- Government of Ghana (GoG) (1992b) PNDC law 207 (Rights to local government), Accra
- Government of Ghana (GoG) (1993a) The Civil Service Law, PNDC Law 327, Accra
- Government of Ghana (GoG) (1993b) Local Government Act, Act 462, Accra
- Government of Ghana (GoG) (1994a) National Development Planning Commission Act, Act 480, Accra
- Government of Ghana (GoG) (1994b) National Development Planning (System) Act, Act 481, Accra
- Government of Ghana (GoG) (1994c) Local Government Instrument 1994 L-I 1589, Accra
- Government of Ghana (GoG) (1994d) National Population Council Act 1994, Act 485
- Government of Ghana, MoH (1995a) *Medium Term Strategic Framework for Health Development in Ghana 1996-2000*.
- Government of Ghana, MoH (1996a) *National Reproductive Health Service and Standards*, MoH
- Government of Ghana (GoG) (1996b) Essential Drugs list and national formulary of Ghana with Therapeutic guidelines. MoH. Third edition
- Government of Ghana (GoG) (1997a) Ghana Health Service Act

- Government of Ghana MoH (1997b) *Health Sector Five Year Programme of Work*, Final POW, February
- Government of Ghana MoH (1997c) Approved Estimates, Guide for Operation, Internal Document, MoH, Accra
- Government of Ghana MoH-TRCD (1993) Annual Report, Technical Co-ordination, Research and Development Unit, MoH
- Grosskurth H et al (1993) 'STD research in Africa' *Lancet* 342:1415-1416
- Grosskurth H et al (1995) 'Impact of improved treatment of sexually transmitted diseases on HIV infection in rural Tanzania: randomised control trial.' *Lancet* 346:530-536
- GSS (1995) *The Pattern of Poverty in Ghana 1988-1992*, Chapter 8 'Health', Study based on Ghana Living Standards Survey
- GSS (Ghana Statistical Services) (1993) *Rural Communities in Ghana*, Report of national rural community survey as part of the 3rd round of Ghana Living Standards Survey, 1991-2.
- GSS Ghana Statistical Survey/USAID/Population Council (1994) *A situation analysis of FP service delivery points in Ghana*
- GSS Ghana Statistical Survey/USAID/Population Council (1997) *A situation analysis of FP service delivery points in Ghana*, 1996.
- Gyekye K (1996) *African Cultural Values*, Ankofa Publishing Company, Philadelphia, Pa./Accra, Ghana
- Handy (1996) On the work of the organisation - and its design. In: *Understanding Organisations*:253-291.
- Hanson S. et al (1997) 'Case management and patient reactions: a study of STD care in a province in Zambia' *International Journal of STD and AIDS* 8(5):329-8
- Hellberg H (1995) 'Tuberculosis programmes: fragmentation of integration?' *Tubercule and Lung Disease*, 76:1-3
- Hiscock J (1995) 'Looking a gift horse in the mouth: the shifting power balance between the Ministry of Health and Donors in Ghana' *Health Policy and Planning* 10(supplement):28-39, Oxford University Press
- Hollos M. and Larsen U. (1997) 'From lineage to conjugality: the social context of fertility decision among the Pare of northern Tanzania' *Social Science and Medicine* 45(3):361-72
- Hublely (1993) *Communicating Health: and action guide to health education and health promotion*, ARTAG, Macmillan publishers, London
- Huntington D. et al (1990) 'User's perspectives of counselling training in Ghana: the "mystery client" trial.' *Studies in Family Planning* 21(3):171-7
- International Conference on Population and Development (ICPD) (1994) *Programme of Action*, Cairo

International Family Health (IFH) (1996) *Strategic Review of the Reproductive Health Sector in Ghana*, Sexual health consultancy for ODA, final report

IPPF (1987) *Better Health Through Family Planning: Recommendations of the International Conference for Women and Children Through Family Planning*, IPPF, Nairobi

IPPF (1989) *Male Involvement in Planned Parenthood*, IPPF, London

IPPF (1993-4) *Annual Report*, London

IWHC (1991) *Reproductive Tract Infections in Women in the Third World: National and International Policy Implications*, Final Report of meeting held by IWHC and Rockefeller Foundation, April 29-May 3, 1991

IWHC (1994) *Challenging the Culture of Silence; Building Alliances to End RTIs*.

Jackson D.J. et al (1997) 'Decreased incidence of sexually transmitted disease among trucking company workers in Kenya: results of a behavioural risk-education programme' *AIDS* 11:903-909

JSA Consultants (1998) 'A Study of Barriers and Opportunities for Integration of Reproductive Health Services in Ghana', Report for London School of Hygiene and Tropical Medicine/Wellcome, unpublished.

Kannae L. and Pendleton B.F. (1998) 'Socio-economic status and use of family planning among Ghanaian government workers' *Social Biology* 45(1-2):113-33

Kasule J. et al (1997) 'Zimbabwean teenagers' knowledge of AIDS and other sexually transmitted diseases' *East African Medical Journal* 74(2):76-81

Kim Y.M. et al (1997) 'Quality of counselling of young clients in Zimbabwe' *East African Medical Journal* 74(8):514-8

Kirby J.P. (1997) 'White, red and black: colour classification and illness management in northern Ghana, *Social Science and Medicine* 44(2):215-30

Knudsen C.O. (1994) *The falling Dawadawa Tree - female circumcision in Developing Ghana*, Intervention press, Denmark

Korboe D. (1995) *Extended Poverty Study: Access and Utilisation of Basic Social Services by the Poor in Ghana*. Report commissioned by UNICEF under Phase 3 of the Ghana Participatory Poverty Assessment series, UNICEF

Kritz M. and Gurak D.T. (1989) 'Women's Status, Education and Family Formation in Sub-Saharan Africa', *International Family Planning Perspectives*, 15(3):100-105

Kumekpor T. and Batse Z.M.K. (1991) 'A critical review of the Ghana Population Policy', Report of National Population Conference, Chapter 7:52-90, Social Sector Policy Unit, Policy Analysis Division, MoFinance and Economic, Accra

Kwansa E (1989) 'Reaching Men: The Ghanaian Experience' paper presented at IPPF Conference on FPP Management

Laga M. (1995) 'STD control for HIV prevention - it works!' *Lancet* 346:518-519

- Lamprey P.R. and Goodridge G. (1996) 'Condoms' in Dallabetta G. et al (1996) *Control of Sexually Transmitted Diseases: a handbook for the design and management of programs* Arlington, VA:AIDSCAP/FHI:73-103.
- Lande R (1993) 'Sexual and Reproductive health: what are the possibilities?' *Planned Parenthood Challenges* 2:19-21
- Lane S D (1992) 'Gender and Health in Rural Egyptian Households' Report for John Hopkins University, USA
- Lane S.D. and Meleis A.I. (1991) 'Roles, work, health perceptions and health resources of women in an Egyptian hamlet' *Social Science and Medicine* 33(10):1197-1208
- Lankoande S. et al (1998) 'Prevalence and risk of HIV infection among female sex workers in Burkina Faso' *International Journal of STDs and AIDS* 9(3):146-50
- Larbi G.A (1995) 'Implications and impact of structural adjustment on the civil service: the case of Ghana', paper 2 of *The role of Government in Adjusting Economies*, ODA
- Lauglo M. (1996) *Population Activities: Framework for Reproductive Health*, Centre for Partnership in Development (DiS)
- LeBacq F. et al (1993) 'HIV and other sexually transmitted diseases at a rural hospital in Zimbabwe' *Genitourin Medicine* 69(5):352-6
- Ledru S. et al (1996) 'Etiologic study of genitourinary infections in women of childbearing age in Bob-Dioulasso, Burkina Faso, 1992' *Sexually Transmitted Disease* 23(2):151-6
- Lee K. and Zwi A. (1996) 'A Global Political Economy Approach to AIDS: Ideology, Interests and Implications', *New Political Economy*, 1(3)
- Leopradi B (1993) 'The role of qualitative studies in policy formulation and development planning' *Qualitative Methods for Population and Health Research*, Yoddumnem-Attig et al (eds):43-48.
- Levy et al (1988) 'Pakistan: Social Marketing of Contraceptives Project', *Contraceptive Social Marketing Assessment: Six Country Reports*, International Science and Technology Institute, Virginia:105-126
- Mabey D (1995) 'Sexually Transmitted Diseases', lecture presented at London School of Hygiene and Tropical Medicine, November, 1995
- Makomwa R. et al (1991) 'Fertility related husband-wife communication in Zimbabwe' *African Research Studies*, UNFPA
- Manderson L 1992. 'Community Participation and Malaria Control in Southeast Asia: Defining the Principles of Involvement.' *Southeast Asia Journal of Tropical Medicine and Public Health*, 23(suppl 1):9-17
- Massing A.W. (1994) *Local Government Reform in Ghana: Democratic Renewal or Autocratic Revival?*, PhD Thesis, Breitenbach, Saarbrücken
- Mayaud P. et al (1997) 'Improved treatment services significantly reduce the prevalence of sexually transmitted diseases in rural Tanzania: results of a randomised control trial' *AIDS* 11:1873-80

- Mayaud P. et al (1998) 'Advances in control of sexually transmitted diseases in developing countries' *Lancet Supplement* 351(suppl III):29-32
- Mayhew S.H. (1996) 'Integrating MCH/FP and STD/HIV services: current debates and future directions' in *Health Policy and Planning* 11(4):339-353
- Mbizvo M.T and Bassett M.T (1996), 'Reproductive health and AIDS prevention in Sub-Saharan Africa: the case for increased male participation', *Health Policy and Planning* 11(1):84-92
- McCaskie T.C. (1983) 'Accumulation, wealth and belief in Asante history I. To the close of the nineteenth century' *Africa*, 53(1)
- McCaskie T.C. (1986) 'Accumulation, wealth and belief in Asante history II. The twentieth century' *Africa*, 56(1)
- Meadows D.H et al (1972) *Limits to growth: A Report to the Club of Rome - Project on the Predicament of Mankind*, Universe Books, New York
- Meda N. et al (1995) 'Sexually transmitted diseases and human immunodeficiency virus infection among women with genital infections in Burkina Faso.' *International Journal of STD & AIDS* 6(4):273-277
- Meda N. et al (1997) 'Pattern of sexually transmitted diseases among pregnant women in Burkina Faso, West Africa: potential for a clinical management based on simple approaches' *Genitourin Medicine* 73(3):188-93
- Mills A. (1983) 'Vertical vs. Horizontal Health Programmes in Africa: Idealism, pragmatism, resources and efficiency', *Social Science and Medicine* 17(24):1871-1981
- Mnyika K.S. et al (1997) 'Determinants of high-risk sexual behaviour and condom use among adults in the Arusha region, Tanzania' *International Journal of STDs and AIDS* 8(3):176-83
- Morse S. (1990) 'Political Economy in Medical Anthropology' in T.M. Johnson and C.F. Sargent, eds. *Medical Anthropology: Contemporary Theory and Methods*, Praeger, NY.
- Moses F. et al (1992) 'Impact of user fees on attendance at a referral centre for sexually transmitted diseases in Kenya' *Lancet* August 340 (8817):463-6
- Mott F. and Mott S. (1985) 'Household Fertility Decisions in West Africa: A Comparison of Male and Female Survey Results' *Studies in Family Planning* 16(2):88-99
- Muecke, M.A. Changing qualitative approaches to reproductive health. In: *Qualitative Methods for Population and Health Research*, edited by Yoddumnem-Attig et al: 21-26.
- Mukaire J (1995) presentation at *Setting the African Agenda 1995*. Africa Region Workshop on Integration of HIV/AIDS with MCH/FP. Workshop Report, Nairobi
- Mwakagile D. et al (1996) 'High frequency of sexually transmitted diseases among pregnant women in Dar-es-Salaam, Tanzania: need for intervention' *East African Medical Journal* 73(10):675-8

Nabila J.S et al (1996) *Adolescent Reproductive Health Needs: Ghana Country Assessment*, University of Ghana, Legon

National Research Council (1989) *Contraception and Reproduction: Consequences for Women and Children in the Developing World*, NRC

Nazzar A. et al (1995) 'Involving a Traditional Community in Strategic Planning: The Navrongo Community Health and Family Planning Project Pilot Study', Paper presented at the Annual Meeting of the Population Association of America, San Francisco, April 6-8, 1995

Ndubani P. (1997) 'The difficulties of compiling a glossary of diseases associated with sexual intercourse in Chiawa, rural Zambia' *Social Science and Medicine*, 44 (8):1211-1220, Pergamon press.

Neequaye A.R et al (1991a) 'A public education campaign against AIDS in Ghana and an evaluation of the response' *Ghana Medical Journal* 25(3-4)

Neequaye A.R et al (1991b) 'Factors that could influence the spread of AIDS in Ghana: knowledge of AIDS, sexual behaviour, prostitution and traditional medical practices' *Journal of Acquired Immuno-Deficiency Syndromes* 4(9)

Network 14(4) 1994.

Ngom P. et al (1995) 'Report on the Community Health and Family Planning Project Survey of Husband and Wives' CHFPP Documentation Note Number 28

Ngugi E.N. et al (1996) 'Focused peer-mediated educational programme among female sex workers to reduce sexually transmitted disease and human immunodeficiency virus transmission in Kenya and Zimbabwe' *Journal of Infectious Disease* 174 (suppl 2):S240-47

Norton P. et al (1995) 'Poverty Assessment in Ghana: using qualitative and participatory research methods' PSP Discussion paper series

Nugent P. (1995) *Big men, Small boys and politics in Ghana*, Pinter publishing, London

ODA (1992) MoH project proposal: Health sector Aid Identification Mission (Annex 4 - 'Health systems in Ghana: structure and function').

ODA (1994) Health and Population Policy Statement, ODA

ODA (1995) Guidance note on How to do a Stakeholder Analysis of Aid Projects and Programmes, UK:ODA

Ofosu-Amaah S. (1981) 'The maternal and child health services in Ghana (their origins and future)' *Journal of Tropical medicine and Hygiene* 84:265-269

Ogden J. (1996) 'Producing Respect: The Proper Woman in Post-Colonial Kampala' in R.P. Werner, ed. *Post Colonial Identities in Africa*, Zed Press, London

Onozaki I. and Shakya T. M. (1995) 'Feasibility study of a district tuberculosis control programme with an 8-month short-course chemotherapy regimen utilising the integrated health service network under field conditions in Nepal', *Tubercule and Lung Disease*, 75:65-71

- Oppenheim-Mason and Taj (1987) 'Differences between mens' and womens' reproductive goals in developing countries', *Population Review*, 13(4)
- Oppong C. (1987) *Sex Roles, Population and Development in West Africa*, Heinmann, Portsmouth, NH
- Oppong C. (1992) Family systems and cultural change, in *Traditional Family Systems in rural settings in Africa*, Berquo E. and Xenos P. (eds):9-86.
- Oquaye and Katsriku (1996), Discussion paper on NGOs, University of Ghana, Legon
- Osteria T.O and Okamura J.Y (eds) (1986) *Participatory Approaches to Development: Experiences in the Philippines*, De La Salle University, Manila, Philippines.
- Over M and Piot P (1991) *Health Sector Priorities Review. HIV Infection and Sexually Transmitted Diseases*. World Bank, Washington D.C.
- Owusu J.Y and Batse Z.M.K (1991) 'Family Planning services in Ghana', Report of National Population Conference, Chapter 10:158-183, Social Sector Policy Unit, Policy Analysis Division, MoFinance and Economic Affairs, Accra
- Pachauri S. (1994) 'Relationship between AIDS and FP programmes: a rationale for developing integrated reproductive health services' *Health Transition Review* 4
- Parsons W. (1995) *Public Policy*, Edward Elgar Publishing Limited, Hants
- Pathfinder International/Population Council (1995) Presentation at *Setting the African Agenda*, Nairobi
- Peeters M. et al (1998) 'Genetic types of HIV type 1 and HIV type 2 strains in commercial sex workers from Bamako, Mali' *AIDS research on Human Retroviruses* 14(1):51-8
- Pellow D. (1994) 'STDs and AIDS in Ghana' *Genitourin Medicine* 70(4):418-423
- Penxa and Blackie (1995) presentation at *Setting the African Agenda Africa Region Workshop on Integration of HIV/AIDS with MCH/FP*. Workshop Report, Nairobi
- Philips D.R (1990) *Health and Health Care in the Third World*, Longmans, London
- Piot P. et al (1988) 'AIDS: An International Perspective' *Science*, 239:573-579
- Pope and Mays (1995a) 'Reaching the parts other methods cannot reach: an introduction to qualitative methods in health and health services research' *British Medical Journal*, 311:42-45
- Pope and Mays (1995b) 'Rigour in Qualitative Research', *British Medical Journal*, 311:109-112
- Population Council 1994 *Critical Issues in Reproductive Health and Population - Partners for Prevention*, New York, Population Council.
- Population Council (1995a) internal report, unpublished document
- Population Council (1995b) *Setting the African Agenda*, Report of Africa Region workshop on integrating STD/HIV and MCH/FP services.

- Population Council (1996) 'Findings from Phase 1 of the Navrongo Community Health and Family Planning project' *Update 5*
- Population Crisis Committee 1990, Report.
- Population Reports (1991a) 'Why Counselling Counts' Series J.36, John Hopkins University, Baltimore, 1991.
- Population Reports (1991b) 'Paying for Family Planning' Series J.39, John Hopkins University, Baltimore, 1991.
- Population Reports (1992) Series M.10, John Hopkins University, Baltimore, 1992.
- Population Reports (1993) 'Controlling Sexually Transmitted Diseases' Series L.9, John Hopkins University, Baltimore, 1993.
- Population Reports (1994a) 'Thirty Years of Family Planning Programmes' Series J.40, John Hopkins University, Baltimore, 1994.
- Population Reports (1994b) 'Opportunities for Women Through Reproductive Choice', Series M.12, John Hopkins University, Baltimore, 1994.
- Population Reports (1995) Series J.41, John Hopkins University, Baltimore, 1994.
- Population Services International (1994) *PSI Highlights: AIDS prevention, family planning and child survival*, Washington DC, PSI, 1994.
- Post Cairo Working Group (1995) 'Strategies for the next ten years: Summary of findings', Women's Health Project News, 13:11-12, Centre for Health Policy, Johannesburg, February, 1995.
- Potts M. 1995. Closing Remarks, *Setting The African Agenda*. Regional workshop on Integration of HIV/AIDS with MCH/FP.
- PPAG-HRU (MoH) (1992) Survey on abortion rates in FP clients attending PPAG clinics in Ghana, Accra, 1992 (unpublished).
- PPAG (1995) Survey on STD awareness among young people in Ashanti Region, PPAG-Kumasi, 1995 (unpublished)
- Pradevand P. (1992) 'Empowering Women of the Sahel', *People and Planet*, 1(1-2):22-25, 1992.
- Prevention of Maternal Mortality Network (1992) 'Barriers to treatment of Obstetric Emergencies in Rural Communities of West Africa', *Studies in Family Planning*, 24(6):279-291, 1992.
- Quaye R. (1996) *Understanding Development and Health Care in Africa - The Ghanaian Experience* Mellen University Press, NY, 1996.
- Rabinow P. (ed) (1991) *The Foucault Reader: An introduction to Foucault's thought*, London, Penguin, 1991.

- Rakodi C. (1996) 'The Opinions of Health and Water Service users in Ghana' *The Role of Government In Adjusting Economies, paper 10*, June 1996.
- Rathbone R. (1973) 'Business men and politics: party struggles in Ghana, 1949-1957', *Journal of Development Studies*, 9(3)
- Rathbone R. (1983) 'Parties' socio-economic bases and regional differentiation in the rate of change in Ghana' in Lyon P. and Manor J. (eds), *Transfer and Transformation: Political Institution in the New Commonwealth*, Leicester, Leicester University Press
- Reich M.R. (1993) *Political Mapping on Health Policy: Draft Guidelines*, unpublished paper. Harvard School of Public Health, Harvard
- Reich, M.R. (1996) 'Applied Political Analysis for health policy reform' *Current Issues in Public Health* 2:186-191
- Renne E.P. (1993) 'Gender ideologies and fertility in an Ekiti Yoruba village' *Studies in Family Planning* 24(6):343-353
- Richters A. (1992) 'Introduction', *Social Science and Medicine*, 35(6):747-751
- Richardson et al (1992) 'Should the Nurses be Blamed?', Ghana Medical School/MoH, Accra
- Rifkin S and Walt G (1986) 'Why Health Improves: Defining the Issues Concerning 'Comprehensive Primary Health Care' and 'Selective Primary Health Care'' *Social Science and Medicine* 23(6):559-566
- Riji H M 1992. 'Adopting The Primary Health Care Approach in Malaria Control in Malaysia: Lessons in Community Participation', *Southeast Asia Journal of Tropical Medicine and Public Health*, 23(suppl 1):18-22
- Rimmer D. (1992) *Staying Poor: Ghana's political Economy 1950-1990*, World Bank, Pergamon Press
- Robson (1993) *Real World Research*, Blackwell, Oxford
- Ronald A.R. (1998) Forward, *Lancet, Supplement* 351(suppl III):1
- Rose (1995) *Family and Reproductive Health Appraisal Study Report*, Save the Children Fund
- Rose (1996) *Projects supported under the Family and Reproductive Health Programme*, Save the Children Fund
- Rosenberg M.J. et al (1992) 'Barrier contraceptives and sexually transmitted diseases in women: a comparison of female-dependent methods and condoms' 82(5):669-74
- Rothchild D (1991) *Ghana, the political economy of recovery*, Lynne Rienner Publishers, Boulder and London
- Rural Help Integrated (RHI) (1995) 'The role of Chiefs, Assembly men and Opinion leaders in family planning activities in the communities', Workshop report. Bolgatanga
- Rural Help Integrated (RHI) (1996) *Annual Report for 1996*. Bolgatanga

Rusakaniko S. et al (1997) 'Trends in reproductive health knowledge following a health education intervention among adolescents in Zimbabwe' *Central Africa Journal of Medicine* 43(1):1-6, 1997.

Safilios-Rothschild C. (1985) 'The Status of Women and Fertility in the Third World in the 1970-1980 Decade', Centre for Population Studies, Working Paper no. 118:1-22, 1985.

Sai F. 1995. Keynote address, *Setting The African Agenda*. Regional workshop on Integration of HIV/AIDS with MCH/FP.

Sangare L. et al (1997) 'HIV infection among pregnant women in Burkina Faso: a nationwide serosurvey' *International Journal of STDs and AIDS* 8(10):646-51, 1997.

Schneider H (1994) 'A Strategy for incorporating STD management into family planning services', an occasional paper, Centre for Health Policy, Johannesburg, September, 1994.

Schneider H (1995) *An Assessment of Services for the Control of Sexually Transmitted Diseases in the PWV Province*, Technical report, Centre for Health Policy and National AIDS programme,

Senah K.A (1997) *Money be Man - The popularity of medicines in a rural Ghanaian society*, Het Spinhuis Publishers, Amsterdam, 1997.

Setting the African Agenda 1995. Africa Region Workshop on Integration of HIV/AIDS with MCH/FP. Workshop Report, Nairobi, 1995.

Shultz K.F. et al 1992. 'Maternal Health and Child Survival: Opportunities to Protect Both Women and Children From the Adverse Consequences of Reproductive Tract Infections', *Reproductive Tract Infections* ed. Germaine A. et al, New York Press, 1992.

Sinei S.K.A et al (1996) 'Contraceptive Use and HIV Infection in Kenyan Family Planning Clinic Attenders', *International Journal of STD and AIDS*, 7:65-70, 1996.

Smith D.L. and Bryant H. (1988) 'Building the infrastructure for Primary Health Care: An overview of vertical and integrated approaches' *Social Science and Medicine* 26(9):909-917, 1988.

Songsore J and Denkabe A (1995) *Challenging rural poverty in Northern Ghana: The case of the Upper West Region*, The University of Trondheim, Centre for Environment and Development Unit - SMU, report no. 6/95, 1995.

Sylvester G. and Abu K. (1995) 'GTZ Primary Health Care in the Northern Region: Phase One (the survey) of the Health Utilisation Study: Bole and Savelugu/Nanton Districts, Report to Ministry of Health, Accra, 1995

Tang Lin-Hua et al 1991. 'Malaria and its Control in the People's Republic of China' *Southeast Asian Journal of Tropical Medicine and Public Health*, 22(4):467-476, 1991.

The EVALUATION Project (1993) 'Indicators of care in International Family Planning Programmes', The Evaluation Project, Carolina Population Centre, 1993.

Thomas T. et al (1996) 'Identifying cervical infection among pregnancy women in Nairobi. Kenya: limitations of risk assessment and symptom-based approaches' *Genitourin Medicine* 72(5):334-8, 1996.

Thongkrajai E (1994) *Feasibility of Integrating STD Services and STD/HIV/AIDS Prevention into MCH/FP Programme in Thailand*, Final Report, Faculty of Nursing, Khon Kaen University, Thailand.

Tinker A et al (1995) *Improving Reproductive Health: The Role of the World Bank*, World Bank

Tonah S. (1993) *The development of agro-pastoral households in Northern Ghana: policy analysis, project appraisal and future perspectives*, PhD Thesis, Breitenbach, Saarbrücken, Germany

Tremblay M.A. (1982) The Key Informant technique: A Non-Ethnographic Application. In: *Field Research: A Sourcebook and Field Manual*, Burgess R.G. (ed.):98-104

Tsey K. (1997) 'Traditional Medicine in Contemporary Ghana: a Public Policy Analysis' *Social Science and Medicine* 45(7):1065-1074

Tsui A.O. et al (eds) (1997) *Reproductive health in developing Countries*, National Academy Press, Washington DC

Twahir A (1995) presentation at *Setting the African Agenda 1995*. Africa Region Workshop on Integration of HIV/AIDS with MCH/FP. Workshop Report, Nairobi

Twumasi P.A (1975) *Medical Systems in Ghana - A study in Medical Sociology*, Ghana Publishing Corporation

Twumasi P.A (1979) 'A social history of the Ghanaian pluralistic medical system' *Social Science and Medicine* 13B:349-356

UN (1979) *Ghana's National Experience in the Formulation and Implementation of Population Policy 1960-76*, UN

UN (1995) *Fourth World Conference on Women*, Platform of Action, Beijing, September 4-15, 1995

UNAIDS (1996) *Response to the HIV/AIDS Epidemic in Ghana*, Ghana Country Office

UNDP (1994) African Network on Ethics, Law and HIV, Dakar Declaration, 1 July 1994

UNFPA (1988) UNFPA-Ghana project, report on 2-day conference of Information Network Sub-Committee on Population/FLE and Communication Activities in Ghana

UNFPA (1991) *State of the World's Population Report*, UNFPA

UNFPA (1995) GoG/UNFPA Third Country Programme 1996-2000, Ghana Country Office

UNFPA (1997) Report of Final Tripartite Review Meeting, Strengthening MCH/FP services in Ghana project GHA/94/PO4, 24th February 1997.

Unger J P and Killingsworth J (1986) 'Selective Primary Health Care: a critical review of methods and results' *Social Science and Medicine* 22:1001

UNICEF (1992) *The State of the World's Children*, UNICEF

UNICEF (1996) *HIV/AIDS Prevention and Care Activities in Ghana*, Ghana Country Office

- USAID (Stanton D.L et al) (1994a) *Assessment of Private Sector STD Diagnosis and Treatment*, Draft report submitted by Marketing and Social Research Institute to USAID
- USAID (1994b) GHANAPA Project Document, Ghana Country Office
- Van der Veen F. H. et al 1994. 'Management of STDs and cost of treatment in primary health care centres in Pikine, Senegal', *International Journal of STD & AIDS* 5(4):262-267
- Vuylsteke B. et al (1993) 'Clinical algorithms for the screening of women for gonococcal and chlamydial infection: evaluation of pregnant women and prostitutes in Zaire' *Clinical Infectious Disease* 17(1):82-8
- Waddington C. and Enimayew K.A (1990) 'A price to pay, part 2: The impact of user charges in the Volta region of Ghana' *International Journal of Health Planning and Management* 5:287-312
- Wagner H. U et al 1994. Seroprevalence and incidence of sexually transmitted diseases in a rural Ugandan population.' *International Journal of STD & AIDS* 5(5):332-337
- Wallman S. (1996) *Kampala Women Getting By*, James Currey, London
- Wallman S. (1998) 'Ordinary women and shapes of knowledge: perspectives on the context of STDs and AIDS' *Public Understanding Science*, 7:169-185, IOP publishing.
- Walsh J.A and Pollock (1995) Report presented at *Setting the African Agenda*, Nairobi
- Walsh J.A and Warren K.S (1979) 'Selective primary Health Care: An Interim Strategy for Disease Control in Developing Countries' *New England Journal of Medicine*, 301(18)
- Walt G (1994) *Health Policy: an introduction to process and power* Zed books, London
- Walt G (1995a) *The Health Policy Process*. Paper prepared for WHO working group on Health Research and Development Priorities: Health Policies and Systems, LSHTM, London
- Walt G (1995b) *Implementing Health Care Reforms: A Framework for discussion*, unpublished paper
- Walt G and Gilson L (1994) 'Reforming the health sector in developing countries: the central role of policy analysis' *Health Policy and Planning* 9(4):353-370
- Wasserheit J.N (1990) 'Reproductive Tract Infections' *Special Challenges in Third World*
- Welsh M. et al (1997) 'Sexually transmitted disease risk assessment used among low-risk populations in east central Africa: a review' *East African Medical Journal* 74(12): 764-71
- WHO (1991) *Management of Patients with STDs: Report of a WHO Study Group*, WHO Technical Report Series, no.810, Geneva
- WHO/GPA (1984) *Improved Strategies for Std Control at PHC Level: Working Group Report*, Geneva
- WHO /GPA (1989) *Report of Consultation on STDs as a Risk Factor for HIV Transmission*, Geneva

- WHO/GPA (1990a) *Consensus Statement from the Consultation on Global Strategies for the Co-ordination of AIDS and STD Control Strategies*, Geneva 11-13 July, 1990.
- WHO/GPA (1990b) *AIDS Prevention: Guidelines for MCH/FP Programme Managers 1 AIDS and FP*, WHO/MCH/GPA/90.1, Geneva
- WHO/GPA (1994) *Management of Sexually Transmitted Diseases*, GPA/TEM/94.1, Geneva
- WHO-HRP (1990-91) Biennial Report. *Reproductive Health: A Key to a Brighter Future. Twentieth Anniversary Report* WHO, Geneva
- WHO-HRP (1992-3) Biennial Report *Challenges in Reproductive Health Research*. WHO, Geneva.
- WHO-HRP (1994) *Expanding Family Planning Options* WHO/HRP/ITT 94.1, Geneva
- WHO/UNICEF (1978) *Primary Health Care: A report of the International Conference on PHC, Alma Ata, USSR, WHO*
- WHO/VDT (1985) *Improved Strategies for STD Control at PHC Level*. Working Group Report, Geneva
- WHO/VDT (1989) *Strategies for Treating STDs*, Consultation, Geneva
- Wilks I. (1975) *Asante in the nineteenth century: The structure and evolution of a political order*, Cambridge, Cambridge University Press
- Wilks I. (1993) *Forests of Gold: Essays on the Akan Kingdom of Asante*, Athens, Ohio University Press
- Wood K. et al (1998) "He forced me to love him": putting violence on adolescent sexual health agendas' *Social Science and Medicine* 47(2):233-42
- World Bank (1984) *World Development Report*, Oxford University press, New York
- World Bank (1993a) *Ghana 2000 and Beyond: Setting the stage for accelerated growth and poverty reduction* Africa regional office, WAF report
- World Bank (1993b) *World Development Report 1993: Investing in Health*. Oxford University press, New York
- World Bank (1994) *Adjustment in Africa: reforms, results and the road ahead*. Oxford University press, New York
- World Bank (1995) *Investing in People: The World Bank in Action*, Directions in Development Series, World Bank, Washington D.C.
- Wynendaale B. et al (1995) 'Impact of counselling on safer sex and STD occurrence among STD patients in Malawi.' *International Journal of STD & AIDS* 6(2):105-109
- Young A. (1982) 'The Anthropologies of Illness and Sickness' *Annual Review of Anthropology* 11, pp257-285
- Zabin L.S. and Kiragu K. (1998) 'The health consequences of adolescent sexual and fertility behaviour in sub-Saharan Africa' *Studies in Family Planning* 29(2):210-32

Zhang L-X and Kan G-Q 1992. 'Tuberculosis control programme in Beijing', *Tubercule and Lung Disease*, 73:162-166