

**ZOOPHILIC AND ANTHROPOPHILIC BEHAVIOUR
IN THE *ANOPHELES GAMBIAE* COMPLEX**

Helen Victoria Pates

**Thesis submitted for the degree of Doctor of Philosophy
to the University of London**

**London School of Hygiene and Tropical Medicine
Department of Infectious and Tropical Diseases
Disease Control and Vector Biology Unit**

April 2002

Abstract

The work included in this thesis arose from a long-standing interest in the possible use of genetic control for one of the most important malaria vectors in Africa, *Anopheles gambiae sensu stricto*. It was hoped that the genes involved in animal biting in the sibling species *Anopheles quadriannulatus* could be exploited by crossing with *An. gambiae s.s.* and using the fertile female hybrids for successive backcrosses to *An. gambiae s.s.*. It was envisaged that this method could be used in an attempt to produce a mosquito stock that is harmless to humans because it is zoophilic but with the genetic background of *An. gambiae s.s.* so that there would be no barriers to cross-mating in the wild. The innate host preference of mosquitoes can be determined in the laboratory using an olfactometer, or in the field using baits. Host-selection patterns in nature are often affected by external factors, which may or may not mask the host preference of the mosquito species in question (discussed in section 1.3).

The main aim of this work was to investigate the host preferences of the two most behaviourally diverse members of the *Anopheles gambiae* complex (*An. gambiae s.s.* and *An. quadriannulatus*) and to attempt to modify the anthropophilic host preference of *An. gambiae s.s.* by hybridisation experiments with the zoophilic *An. quadriannulatus*. The behaviour of these two sibling species was assessed in an olfactometer by testing a range of odours. *Anopheles gambiae s.s.* behaved as expected and was attracted to human odours. However, the behaviour of *An. quadriannulatus* was somewhat unexpected and a large proportion also selected human odour. Therefore an outdoor host-choice experiment was performed and confirmed the olfactometer findings. A standardised bioassay was developed to evaluate the behaviour of mosquitoes resulting from the crossing experiments. Human and cow skin washings were prepared and tested. Cow skin washing combined with carbon dioxide and tested against a control of clean air was then chosen to evaluate the behaviour of hybrids and backcrossed mosquitoes in the olfactometer. Three backcrosses to both *An. gambiae s.s.* and *An. quadriannulatus* were performed, which showed extreme stability of the anthropophilic trait. A field study in Ethiopia investigated the host preference of *An. quadriannulatus* species B and suggested that this species is more zoophilic than its sibling species *An. arabiensis* but is also attracted to humans. The impact of these findings on our current understanding of the behaviour of members of the *Anopheles gambiae* complex is discussed.

For Hans

DECLARATION

I hereby declare that the work contained in this thesis (entitled “Zoophilic and anthropophilic behaviour in the *Anopheles gambiae* complex) is essentially my own work. However, I acknowledge the assistance of O. Akinpelu (LSHTM) and G.S. Gill (LSHTM) who performed the precipitin tests described in section 3.3 and K. Stuke (Wageningen University) for her assistance with some of the experiments described in figure 3.1.3. I also recognise Dr. Cally Roper for the use of her microsatellite data, described in chapter 7.



Helen Victoria Pates

May 2002

ACKNOWLEDGEMENTS

The work presented in this thesis was carried out in collaboration with Wageningen University in the Netherlands and is a result of a project that received financial support from the UNDP/ World Bank/ WHO programme for Research and Training in Topical Diseases (TDR) and the Laboratory of Entomology at Wageningen University. The field study in Ethiopia and subsequent analysis of material (chapter 6) was funded by a Garnham Fellowship from the Royal Society of Tropical Medicine and Hygiene and a grant from the Wellcome Trust.

I am indebted to my two supervisors, Professor Chris Curtis and Dr. Willem Takken for all of their support and encouragement throughout my PhD. I would like to thank Dr. Jo Lines for his assistance with the Ethiopian work and Dr. Cally Roper for all her help, enthusiasm and data used in the microsatellite analysis (chapter 7). I am very grateful to O. Akinpelu for her technical assistance and G.S. Gill and L. Tsang for their help with precipitin tests.

I am extremely grateful to the Laboratory of Entomology at Wageningen University and Professor J.C. Van Lenteren for having made my stay possible. I would like to give my thanks in particular to the following: F. van Aggelen, A. Gidding and L. Koopman, K. Stuke, R.C. Smallegange, M.A.H. Braks, P.W. Huisman, P. Schneider, H. Smid and T. Dekker. I would like to thank P. Kostense for drawing figure 2 and figure 3.3.1 and G. Gort for his help with statistical analysis. I would also like to thank 'De Ossekampen' for providing the calf and the many 'cow socks' used in chapter 3.

I would like to extend my gratitude to Dr. Steven Sinkins for all his genotyping work at the beginning of this project and Dr. Alessandra Della Torre for her cytotoxic analysis of the mosquito colonies. I am also very grateful to Professor Maureen Coetzee and Dr. Richard Hunt of the South African Institute of Medical Research for their support and supply of *An. quadriannulatus* eggs when needed. I would like to thank Jimma University for their collaborative role in the work presented in chapter 6, A. Haddis for his help during my stay in Ethiopia and M. Fettene for his help in Ethiopia and some laboratory identification of *An. quadriannulatus* species B. I would also like to thank my husband Hans Jamet, for all of his technical assistance and emotional support throughout.

CONTENTS

ABSTRACT	2
DEDICATION	3
DECLARATION	4
ACKNOWLEDGEMENTS	5
TABLE OF CONTENTS	6
LIST OF FIGURES	11
LIST OF TABLES	14

Chapter 1 INTRODUCTION

1.1 General Introduction	16
1.2 Aims and objectives	27
1.2.1 General aim	27
1.2.2 Specific aims	27
1.3 Determination of mosquito host preference	28
1.3.1 Introduction	28
1.3.2 The human blood index as a measure of host preference	28
1.3.3 Zoophilism with malaria and the use of zooprophylaxis	39
1.3.4 Divergent host preferences in members of species complexes	43
1.3.5 The genetics of host preference	50
1.3.6 Host choice and memory	51
1.3.7 Discussion	53

Chapter 2 GENERAL MATERIALS & METHODS

2.1 Mosquito colonies and rearing procedures	54
2.1.1 <i>Anopheles gambiae sensu stricto</i> (SUA strain)	54
2.1.2 <i>Anopheles quadriannulatus</i> species A (SKUQUA strain)	55
2.1.3 <i>Anopheles quadriannulatus</i> species A (SANGQUA strain)	55

2.1.4	Colour marking mosquitoes	56
2.2	The Olfactometer	56
2.3	Preparation of odour stimuli	57
2.3.1	Carbon dioxide, acetone and octenol	57
2.3.2	Skin emanations	57
2.4	Olfactometer bioassay: experimental procedure	58
2.5	Statistical analysis of olfactometer experiments	58
2.6	Identification of members of the <i>Anopheles gambiae</i> complex using primers specific for the ribosomal DNA intergenic spacer	60
2.6.1	DNA extraction	60
2.6.2	Polymerase chain reaction (PCR) protocol	60
2.7	The precipitin test for identification of bloodmeal origin	61

Chapter 3 BEHAVIOURAL RESPONSES OF *ANOPHELES GAMBIAE SENSU STRICTO* & *ANOPHELES QUADRIANNULATUS* TO HUMAN & COW ODOURS IN THE LABORATORY

3.1	Differential behaviour of <i>Anopheles gambiae sensu stricto</i> to human and cow odours in the laboratory	62
3.1.1	Introduction	62
3.1.2	Materials & Methods	62
3.1.3	Results	62
	<i>3.1.3.1 Response to skin emanations</i>	63
	<i>3.1.3.2 Response to carbon dioxide</i>	63
3.1.4	Discussion	68
3.2	Response of <i>Anopheles quadriannulatus</i> to human and animal odours in the laboratory	71
3.2.1	Introduction	71
3.2.2	Materials & Methods	71
3.2.3	Results	71
	<i>3.1.2.1 Response to carbon dioxide and octenol</i>	72
	<i>3.2.3.2 Response to skin emanations</i>	72
3.2.4	Discussion	75

3.3	Further investigation of attraction of <i>Anopheles quadriannulatus</i> to human odour	79
3.3.1	Introduction	79
3.3.2	Materials & Methods	79
	3.3.2.1 <i>Mosquitoes</i>	79
	3.3.2.2 <i>Study site & season</i>	79
	3.3.2.3 <i>Procedure</i>	79
	3.3.2.4 <i>Data analysis</i>	80
3.3.3	Results	82
	3.3.3.1 <i>Effect of weather on biting behaviour</i>	83
	3.3.3.2 <i>Bloodmeal analysis</i>	83
3.3.4	Discussion	85
3.4	Differential response of <i>Anopheles gambiae</i> s.s. and <i>An. quadriannulatus</i> to two individuals	87
3.4.1	Introduction	87
3.4.2	Materials & Methods	87
3.4.3	Results	87
3.4.4	Discussion	90

Chapter 4 STANDARDISATION OF THE OLFACTOMETER BIOASSAY

4.1	Evaluation of the effectiveness of skin washings in the olfactometer	92
4.1.1	Introduction	92
4.1.2	Materials & Methods	92
	4.1.2.1 <i>Sample collection</i>	92
	4.1.2.2 <i>Extraction process</i>	93
	4.1.2.3 <i>Concentration of the extraction</i>	93
	4.1.2.4 <i>Removal of excess solvent</i>	93
	4.1.2.5 <i>Standardisation of extracts</i>	94
	4.1.2.6 <i>Odour presentation in the olfactometer</i>	94
	4.1.2.7 <i>Olfactometer experiments</i>	94
4.1.3	Results	95
4.1.4	Discussion	98

4.2	A comparison of the response of <i>Anopheles gambiae</i> s.s. and <i>An. quadriannulatus</i> to skin washings in the olfactometer	100
4.2.1	Introduction	100
4.2.2	Materials & Methods	100
4.2.3	Results	100
4.2.4	Discussion	103

Chapter 5 HYBRIDISATION STUDIES TO MODIFY THE HOST PREFERENCE OF *ANOPHELES GAMBIAE*

5.1	Introduction	105
	<i>Blank page</i>	<i>108</i>
5.2	Materials & Methods	109
5.2.1	Crosses with <i>An. quadriannulatus</i>	109
5.2.2	Production of hybrids and backcrosses	110
5.2.3	Hybrids and hybrid male sterility	114
5.2.4	Behavioural studies with hybrids and backcrossed mosquitoes	120
5.2.5	Data analysis	120
5.3	Results	121
5.4	Discussion	124

Chapter 6

FIELD STUDIES ON *ANOPHELES QUADRIANNULATUS* SPECIES B

6.1	General Introduction	130
6.2	Description of study area	131
6.3	Materials & Methods	138
6.3.1	Design of the field study	138
6.3.2	cs-ELISA: Identification of sporozoite positive mosquitoes	140
	<i>6.3.2.1 Mosquito preparation</i>	<i>140</i>
	<i>6.3.2.2 Protocol</i>	<i>140</i>
6.4	Results	142

6.4.1	Composition of light trap catches	142
6.4.2	Composition of resting catches	145
6.4.3	Sporozoite rates and bloodmeal analysis	148
6.5	Discussion	149

Chapter 7

MICROSATELLITE ANALYSIS OF *ANOPHELES QUADRIANNULATUS*

7.1	Introduction	160
7.2	Materials & Methods	162
7.2.1	Mosquito specimens and DNA extraction	162
7.2.2	Microsatellite analysis	164
7.2.3	Statistical analysis	165
7.3	Results	166
7.3.1	Allele frequencies	166
7.3.2	Genetic variability	169
7.4	Discussion	170

Chapter 8 GENERAL DISCUSSION & CONCLUSIONS

8.1	General Discussion	172
8.2	General Conclusions	178

BIBLIOGRAPHY	179
---------------------	------------

Appendix I: SUMMARY OF MICROSATELLITE ANALYSIS OF THREE <i>AN. QUADRIANNULATUS</i> COLONIES	201
--	------------

Appendix II: GEL PHOTOGRAPHS FROM PCR ANALYSIS OF <i>AN. GAMBIAE S.L.</i>	203
--	------------

LIST OF FIGURES

Figure 1.1	Factors contributing to the host-seeking process in mosquitoes	22
Figure 2	Diagram of the dual port olfactometer (A) and mosquito release cages (B) and (C)	59
Figure 3.1.1	Catches of <i>Anopheles gambiae s.s.</i> with skin emanations	65
Figure 3.1.2	Catches of <i>An. gambiae s.s.</i> with human equivalent volumes of carbon dioxide (230mlmin ⁻¹)	66
Figure 3.1.3	Catches of <i>An. gambiae s.s.</i> with calf equivalent volumes of carbon dioxide (1000mlmin ⁻¹)	67
Figure 3.2.1	Catches of <i>An. quadriannulatus</i> SKUQUA strain with carbon dioxide	73
Figure 3.2.2	Catches of <i>An. quadriannulatus</i> SKUQUA strain with skin emanations	74
Figure 3.2.3	A comparison of the behaviour of <i>An. gambiae s.s.</i> and <i>An. quadriannulatus</i> in the olfactometer	77
Figure 3.3.1	Choice experimental set-up	81
Figure 3.3.2	Feeding preference of <i>An. gambiae s.s.</i> (SUA strain) and <i>An. quadriannulatus</i> (SKUQUA and SANGQUA strain)	84
Figure 3.4	Catches of <i>An. gambiae s.s.</i> and <i>An. quadriannulatus</i> SANGQUA strain with human odour from two individuals	89
Figure 4.1.1	Evaluation of the catches of <i>An. gambiae s.s.</i> with skin washings	96
Figure 4.1.2	Dose-response of <i>An. gambiae s.s.</i> to human skin washings tested on a glass slide in an olfactometer	98
Figure 4.2	Comparison of the catches of <i>An. gambiae s.s.</i> and <i>An. quadriannulatus</i> with skin washings in the olfactometer	102
Figure 5.1	Procedure for cross-mating <i>An. gambiae s.s.</i> and <i>An. quadriannulatus</i> , selection of zoophilic F ₁ individuals, backcrossing to each parental species and testing the 1 st backcross progeny	113
Figure 5.2	Procedure for cross-mating <i>An. gambiae s.s.</i> and <i>An. quadriannulatus</i> and three generations of backcrossing to each parental species	113
Figure 5.3	The normal male reproductive system of <i>An. gambiae s.s.</i> (x100)	114

Figure 5.4	View of vas efferens/ testis junction containing coils of mature spermatozoa in <i>An. gambiae s.s.</i> (negative= x1000)	115
Figure 5.5	The male reproductive system of an <i>An. gambiae s.s.</i> x <i>An. quadriannulatus</i> hybrid (negative= x100)	115
Figure 5.6	(A) Hybrid testis (negative= x400)	116
	(B) Hybrid testis (negative= x400)	116
	(C) Hybrid testis (negative= x1000)	116
Figure 5.7	The reproductive system of a male resulting from a hybrid backcrossed to <i>An. quadriannulatus</i> (negative= x25)	117
Figure 5.8	(A) View of a ruptured testis from a male resulting from a hybrid backcrossed to <i>An. quadriannulatus</i> (negative= x160)	118
	(B) High power view of contents from ruptured testis (negative= x1000)	118
Figure 5.9	The reproductive system of a fertile male resulting from a hybrid backcrossed to <i>An. gambiae s.s.</i> (negative= x100)	119
Figure 5.10	A reduced testis containing immature spermatids from a male resulting from a hybrid backcrossed to <i>An. gambiae s.s.</i> (negative= x160)	119
Figure 5.11	Zoophilic index for <i>An. gambiae s.s.</i> , <i>An. quadriannulatus</i> , hybrids and mosquitoes backcrossed to both parents in (A) study 1 and (B) study 2	123
Figure 5.12	Degree of sterility in males resulting from <i>An. gambiae s.s.</i> x <i>An. arabiensis</i> hybrid females backcrossed to <i>An. gambiae s.s.</i> males	126
Figure 6.1	(A) Map of Ethiopia showing the main cities, towns and borders	133
	(B) Malaria risk map for Ethiopia	133
Figure 6.2	(A) A man ploughing a field with his cow and wooden plough in a field in the Jimma Valley	134
	(B) View of Serbo town, the nearest market town serving the villages of Babo, Minko and Abukako	135
	(C) A typical <i>Tukul</i> with some of its inhabitants	136
Figure 6.2	(D) A rectangular house with mud walls and a corrugated iron roof with some of its inhabitants	136
	(E) The cooking area inside a <i>Tukul</i>	137
	(F) A window in a rectangular house with mud walls	137

	(G) Corrugated iron roofing on the rectangular house shown in 6.2 (D)	138
Figure 6.3	(A) Sketch map of the study site in the Jimma region of Ethiopia	141
	(B) Ariel plan of light trap catching stations	141
Figure 6.4	The morphological species composition of light traps in three types of housing after 5 nights of trapping	144
Figure 6.5	The composition of <i>An. gambiae s.l.</i> entering light traps in three housing types in 5 nights	145
Figure 6.6	Distribution and species composition of mosquitoes caught in resting catches in three housing types in Babo and Abukako	147
Figure 6.7	Distribution of <i>An. gambiae s.l.</i> caught in resting catches in human houses and cattle sheds in Babo and Abukako	148
Figure 7.1	An electropherogram for four <i>An. quadriannulatus</i> species A SANGQUA strain mosquitoes at locus 803	167
Figure 7.2	Allele composition of some wild caught <i>An. gambiae s.l.</i> populations at locus 803	168
Figure 7.3	Allele composition of <i>An. quadriannulatus</i> species A colony populations at locus 803	168
Figure 8	(A) Phylogeny of members of the <i>An. gambiae</i> complex based on distribution of chromosomal inversions	177
	(B) Phylogeny of members of the <i>An. gambiae</i> complex based on molecular analysis of rDNA	177
Figure II	(A) Gel 1: miscellaneous mosquito samples	203
	(B) Gel 2: mosquitoes caught in light trap set in house occupied by humans only (in Babo, Jimma Valley, Ethiopia)	204
	(C) Gel 3: mosquitoes caught in light trap set in cow shed (in Babo, Jimma Valley, Ethiopia)	205
	(D) Gel 4: mosquitoes caught in light trap set in house occupied by humans and animals (in Babo, Jimma Valley, Ethiopia)	206

LIST OF TABLES

Table 1.1	Biology of the <i>Anopheles gambiae</i> complex	20
Table 1.2	A summary of the identification procedures used for members of the <i>Anopheles gambiae</i> complex	21
Table 1.3.1	The proportion of human bloodmeals identified in a variety of anophelines	33-34
Table 1.3.2	The proportion of human bloodmeals identified from members of the <i>Anopheles gambiae</i> complex	35-38
Table 2.1	Recipe for PCR mastermix	61
Table 3.3.1	Meteorological data recorded during the experimental nights	82
Table 3.3.2	Total number of mosquitoes released, recaptured and fed throughout the 6-night study period	82
Table 3.3.3	Logistic regression statistics for Type I analysis; testing the effect of day and mosquito type on the proportion human bloodmeals analysed	83
Table 4.1	Total number of <i>An. gambiae s.s.</i> caught in each trap of the olfactometer after 6 experimental days testing the dose-response to human skin washings	97
Table 5.1	Percentage of males and degree of sterility in the F ₁ generation resulting from crosses between <i>An. quadriannulatus</i> species A and other members of the <i>An. gambiae</i> complex	107
Table 5.2	Percentage egg hatch, adult eclosion and sex ratios from crosses between female <i>An. gambiae s.s.</i> and male <i>An. quadriannulatus</i> and from backcrosses	112
Table 5.3	Results from behavioural experiments with hybrids and mosquitoes backcrossed to <i>An. gambiae s.s.</i> and <i>An. quadriannulatus</i>	122
Table 6.1	Composition of light trap catches over 5 nights in three catching stations	143
Table 6.2	Species composition of resting catches	146
Table 6.3.	Results of circumsporozoite ELISA for <i>An. gambiae s.l.</i> caught in light trap catches and resting catches	149
Table 6.4	A summary of the bloodmeal origin of mosquitoes caught in resting catches, identified by the precipitin test	149
Table 6.5	The ratio of <i>An. arabiensis</i> : <i>An. quadriannulatus</i> caught in	

	different habitats in the Jimma region of Ethiopia	153
Table 6.6	The sporozoite rate and human blood index in <i>An. arabiensis</i> collected from indoor resting catches in Ethiopia	156
Table 7.1	Genetic variability at locus 803 for the five <i>An. gambiae s.l.</i> populations studied	163
Table 7.2	Pair-wise F_{ST} values for each pair of <i>An. gambiae s.l.</i> populations studied	169
Table 7.3	P values for pair-wise F_{ST} between populations	169
Table I	Allele size (estimated base pairs) for three <i>An. quadriannulatus</i> colonies and an <i>An. gambiae s.s.</i> colony tested with primer 46	202

Chapter 1

INTRODUCTION

1.1 General introduction

Anopheles gambiae sensu stricto is the most efficient malaria vector in Africa partly because of its high degree of anthropophily (preference for feeding on humans). This mosquito belongs to the *Anopheles gambiae* complex, which comprises six named sibling species, one unnamed species and several 'incipient' species (Coetzee *et al.*, 2000) (see table 1.1). The existence of saltwater tolerant forms of *An. gambiae* was recognised in the 1940's (Ribbands, 1944; Muirhead-Thomson, 1948). Early crossing experiments between dieldrin resistant and susceptible strains of *An. gambiae* from Nigeria (Davidson, 1956) first indicated the existence of two freshwater forms, which was later confirmed by Davidson and Jackson (1962). Subsequent crossing experiments identified the other members of the complex (Paterson *et al.*, 1963; Davidson and Hunt, 1973) including most recently *Anopheles quadriannulatus* species B (Hunt *et al.*, 1998). Hybridisation between sibling species is rare in the field (reported frequencies ranging between 0.05% - 0.22% (White, 1971, 1974a; Bryan, 1979; Coluzzi *et al.*, 1979; Petrarca *et al.*, 1991)) as there appear to be very efficient pre-mating barriers between sibling species. However, the confines of a laboratory cage break down these barriers and a laboratory cross results in vigorous hybrids, usually consisting of fertile females and sterile males. It is generally not possible to obtain an F₂ generation but hybrid females can be backcrossed to parent males to produce viable offspring. The degree of male sterility involved varies with the parental type, ranging from testes with wholly undifferentiated tissue to partial spermatogenesis and what appears to be mature spermatozoa (Davidson, 1964a).

The *An. gambiae* complex is a particularly difficult group of mosquitoes to study because of the lack of morphological characters with which to separate them (Coetzee, 1986). Identification of sibling species is considered important for practical malaria control, especially in areas where *An. quadriannulatus* occurs in sympatry with a vector sibling species. A brief summary of methods used in the identification of sibling species in the *An. gambiae* complex is given in table 1.2. Malaria sporozoites have never been found in field caught *An. quadriannulatus*, despite extensive surveys (Coetzee, personal communication). This is probably due to the low anthropophilic index and the frequently cool conditions in many of the habitats occupied (White, 1974a). However, in the laboratory *An. quadriannulatus* species A has been shown to be susceptible to both

malaria (Takken *et al.*, 1999) and the human filariasis parasite, *Wuchereria bancrofti* (Hunt & Gunders, 1990).

There has been interest in the genetic manipulation of mosquitoes for a long time (Curtis, 1968, 1994) and several authors have mentioned the possibility of exploiting the behaviour of mosquitoes from the *An. gambiae* complex (Curtis, 1982; Snow, 1983; Costantini *et al.*, 1999; Curtis *et al.*, 1999; Duchemin *et al.*, 2001). Davidson (1969) suggested that the introduction of sterile males from hybridising different members of the *An. gambiae* complex could be used as an alternative control method. However, focal eradication in rural areas with sterile males is unlikely to be sustainable because of influx of mosquitoes from surrounding areas. Furthermore, the use of heterotic hybrid males in a diverse vectorial system is not supported by theoretical expectations that predict high mating competitiveness in laboratory cages but not in natural conditions (Coluzzi, 1984). A more sustainable method may be the introduction of a strain unable to carry the disease but capable of replacing the original vector population as a result of a genetic 'driving' mechanism after 'seeding' with limited numbers of reared and released insects (Curtis, 1994). An example of such a method would include the use of zoophilic genes from *An. quadriannulatus* in insectary-reared *An. gambiae s.s.*. Such mosquitoes would be expected to have a lower vectorial capacity¹ than 'pure' *An. gambiae s.s.* because the proportion of feeds on humans would be reduced. Release of a zoophilic population may be preferable to releasing genetically engineered *Plasmodium* refractory strains since the latter would tend to select for genes causing evasion of the refractoriness mechanism in the *Plasmodium* parasite (Curtis *et al.*, 1999). Also, there are ethical concerns about releasing any genetically abnormal organism into the wild, especially a female mosquito that could have the potential to bite and transmit diseases other than malaria and to be a nuisance (Spielman, 1994). With a stable zoophilic strain there should be no concerns about the 'nurturing' of a pest with a possible role in transmission of human filariasis or arboviruses because zoophily would prevent transmission of these, as well as preventing nuisance biting. However, it must be recognised that there may be more than one malaria vector involved in transmission in a given area (Maxwell *et al.*, 1999) and therefore in

¹ Vectorial capacity is an expression of the number of infections the population of a given vector would distribute per case per day at a given place and time, assuming conditions of non-immunity. Vectorial capacity is determined by the density of females relative to humans, their longevity, frequency of feeding and propensity to bite humans and the extrinsic cycle of the parasite:

$$C = ma^2p^n / -lnp$$

Where m = number of female anophelines per person, a = daily biting rate of an individual female on humans and a^2 = probability of a mosquito feeding twice on a human, p = daily survival of female *Anopheles*, n = extrinsic incubation period of parasite. The probability of an individual mosquito surviving n days is p^n and the life expectancy of a mosquito at emergence is $1 / -lnp$ (Garrett-Jones, 1964).

order to interrupt transmission there, one would have to produce a population-replacing non-vector strain in not one but two, and perhaps as many as four different species (Curtis *et al.*, 1999).

Davidson (1964a) showed that crosses between *An. quadriannulatus* females and *An. gambiae s.s.* or *An. arabiensis* males produced a marked excess of males that were partially fertile. The reciprocal of this cross produced a normal or near-normal sex ratio with fully fertile females and sterile males. Mass cage crosses can be performed by placing *An. quadriannulatus* males with virgin *An. gambiae s.s.* females. Hybrid female progeny can be backcrossed to either parent (ideally *An. gambiae s.s.* males) to produce viable offspring that can then be tested in an olfactometer using human and/ or animal odour. By selecting zoophilic backcross progeny using the olfactometer, and performing successive backcrossing and selections, it was expected to be possible to produce a mosquito carrying the zoophilic trait but with the genetic background of *An. gambiae s.s.* that would be expected to mate freely with wild *An. gambiae s.s.*

There is a wealth of information regarding host-seeking behaviour in mosquitoes (Gillies, 1980; Sutcliffe, 1987; Gillies, 1988; Takken, 1991; Cork, 1996; Gibson & Torr, 1999; Takken & Knols, 1999) and recent advances regarding the host seeking behaviour (Knols, 1996; Braks, 1999) and identification of sibling species of the *An. gambiae* complex (see table 1.2) have greatly aided studies in the behavioural ecology of this important group of mosquitoes. Host seeking in mosquitoes is governed by many factors including the daily solar cycle, wind speed, the physiological state of the mosquito, long range olfactory responses (motor responses to host odours, which generally occur many metres away from the host, e.g. upwind flight), visual responses and short range responses to odour (e.g. increasing tendency to circle or land on objects, changes in flight speed) (Gibson & Torr, 1999).

The eyes of mosquitoes have relatively poor resolution but high overall sensitivity (Gibson & Torr, 1999); visual stimuli (luminous reflectance and contrast) are used for in-flight orientation and may also be involved in positive anemotaxis (Takken, 1996). This is in contrast to *Glossinidae* species, which have strong visual senses and therefore shape, colour, contrast and patterning are important determinants in attracting flies to hosts and artificial targets (Kelly, 2001). Host-seeking mosquitoes are more attracted to low intensity colours, such as black, red and blue than they are to high intensity colours such as white and yellow (Kettle, 1995); *An. gambiae s.s.* orients to moving stripes on a white background under infra red light (Gibson, 1995) and some nocturnal mosquitoes are more active on moonlit nights than on dark nights (Rubio-Palis, 1992). Diurnal species have the

advantages of good visual cues, high winds that provide good directional cues in host plumes and mobile hosts, which make a 'sit and wait' strategy feasible (Gibson & Torr, 1999). Conversely, nocturnal species have the advantages of reduced risk of desiccation, the host is often quiescent (therefore there is a smaller risk from host defensive behaviour) and there is a reduced risk from predators (Gibson & Torr, 1999). The factors involved in mosquito host-seeking are illustrated in figure 1.1. Feeding success is highly regulated by the host (e.g. defensive behaviour, convection currents, elevated body temperature due to infection) but may also be influenced by other factors such as mosquito density (which can increase the degree of host defensive behaviour). The pattern of contact between blood-sucking insects and their hosts is extremely heterogeneous and non-random (Kelly, 2001). It has been estimated that, on average, 20% of any host population contributes 80% of the net transmission potential and recent evidence suggests that variation in the attractiveness of individual hosts is correlated with defensive behaviour (Kelly, 2001).

Table 1.1. Biology of the *Anopheles gambiae* complex.

Species	Distribution	Larval habitat	Predominant biting behaviour ¹	Predominant resting behaviour ²	Vector status
<i>An. gambiae</i> s.s. ³	Wide (forest/ humid savanna)	Freshwater	Anthropophilic	Endophilic	Malaria, filariasis, O'nyong yong virus
<i>An. arabiensis</i>	Wide (dry savanna), also urban southern Nigeria ⁴	Freshwater	Mixed (anthropophilic/ opportunistic/ zoophilic)	Mixed	Malaria, filariasis, O'nyong yong virus
<i>An. quadriannulatus</i> species A ⁵	southern Africa	Freshwater	Zoophilic	Exophilic	Non-vector
<i>An. quadriannulatus</i> species B ⁵	Ethiopia	Freshwater	Zoophilic	Endophilic	Non-vector
<i>An. merus</i>	East Africa	Saltwater	Mixed	Exophilic	Local vector (malaria, filariasis)
<i>An. melas</i>	West Africa	Saltwater	Mixed	Exophilic	Local vector (malaria, filariasis)
<i>An. bwambiae</i>	Bwamba, Uganda	Mineral springs	Anthropophilic	Endophilic	Local vector (malaria, filariasis)

¹ Anthropophilic = prefers to feed on humans; zoophilic = prefers to feed on animals other than humans.

² Endophilic = prefers to rest indoors; exophilic = prefers to rest outdoors (N.B. difference between endophagic (prefers to feed indoors) and exophagic prefers to feed outdoors)).

³ Five chromosomal forms of *An. gambiae* s.s. have been recognised and named: Forest, Bissau, Savanna, Bamako and Mopti; their distribution depends on environmental and climatic factors.

⁴ Coluzzi *et al.* (1975) and reconfirmed by Kristan *et al.* (2002).

⁵ Before Hunt *et al.* (1998) identified *An. quadriannulatus* species B as a separate sibling species, it was assumed that *An. quadriannulatus* in Ethiopia, southern Africa and Zanzibar were the same species. It is assumed here that information regarding *An. quadriannulatus* from Ethiopia before this discovery relates to *An. quadriannulatus* species B and all information regarding *An. quadriannulatus* from southern Africa relates to *An. quadriannulatus* species A. *Anopheles quadriannulatus* from Zanzibar is omitted since this species was only detected in one set of crossing experiment performed by Odetoyinbo and Davidson (1968) and has not been found in Zanzibar since, despite two animal baited trapping attempts (C.F. Curtis, personal communication) and extensive larval collections (J.D. Lines, personal communication).

Table 1.2. A summary of the identification procedures used for members of the *Anopheles gambiae* complex

<i>Method</i> ¹ :	Hybridisation studies	Morphology	Cytotaxonomy	Isoenzyme analysis	DNA probes	Polymerase Chain Reaction
Technique	Wild caught material crossed with reference lab strains and degree of infertility in progeny investigated	Measurement of hind leg banding patterns; palpal ratio and number of coeloconic sensillae on antennae	Analysis of polytene chromosome banding sequences	Detection of differential migration of enzymes in an electric field by banding patterns	Use of DNA probes for hybridisation with mosquito squash blots	PCR method using ribosomal DNA; based on species-specific nucleotide sequences
Advantages	Technique first used to identify members of complex and still the most sensitive technique ²	Would be applicable by a field entomologist	Highly accurate, standard method of identification, only larvae or half-gravid mosquitoes can be used	Low level of skill required	Useful in field situation, intact mosquito not needed	Can use extracted DNA or a fragment of a specimen such as a leg or intact egg; low level of skill; generally highly accurate
Disadvantages	Live material required, laborious, labour intensive	Highly skilled, no taxonomic characters are exclusive to one sibling species	Highly skilled, adult females need to be at the right stage of egg development	Degree of overlap between certain sibling species; fresh or liquid nitrogen preserved specimens needed	Does not always identify each member of the complex	Sensitivity depends on protocol used and mosquito specimen; may be confusing as non-specific bands often produced
References	Davidson & Jackson (1962); Davidson & Hunt (1973); Hunt <i>et al.</i> (1998)	Bushrod (1981); Coetzee <i>et al.</i> (1982); Coetzee (1986); Coetzee (1987)	Coluzzi <i>et al.</i> (1979); Coluzzi (1989)	Coluzzi (1989); Coetzee <i>et al.</i> (1993); Miles (1979)	Collins <i>et al.</i> (1988a, b); Hill & Crampton (1994)	Scott <i>et al.</i> (1993); Van Rensburg <i>et al.</i> (1996); Cornel <i>et al.</i> (1997)

¹ Analysis of cuticular hydrocarbons and larval salinity tolerance tests have been used to identify sibling species and because there are limitations in the regular use of these methods they have not been included in the table.

² As indicated by the results of Hunt *et al.* (1998) with crosses between *An. quadriannulatus* species A and *An. quadriannulatus* species B.

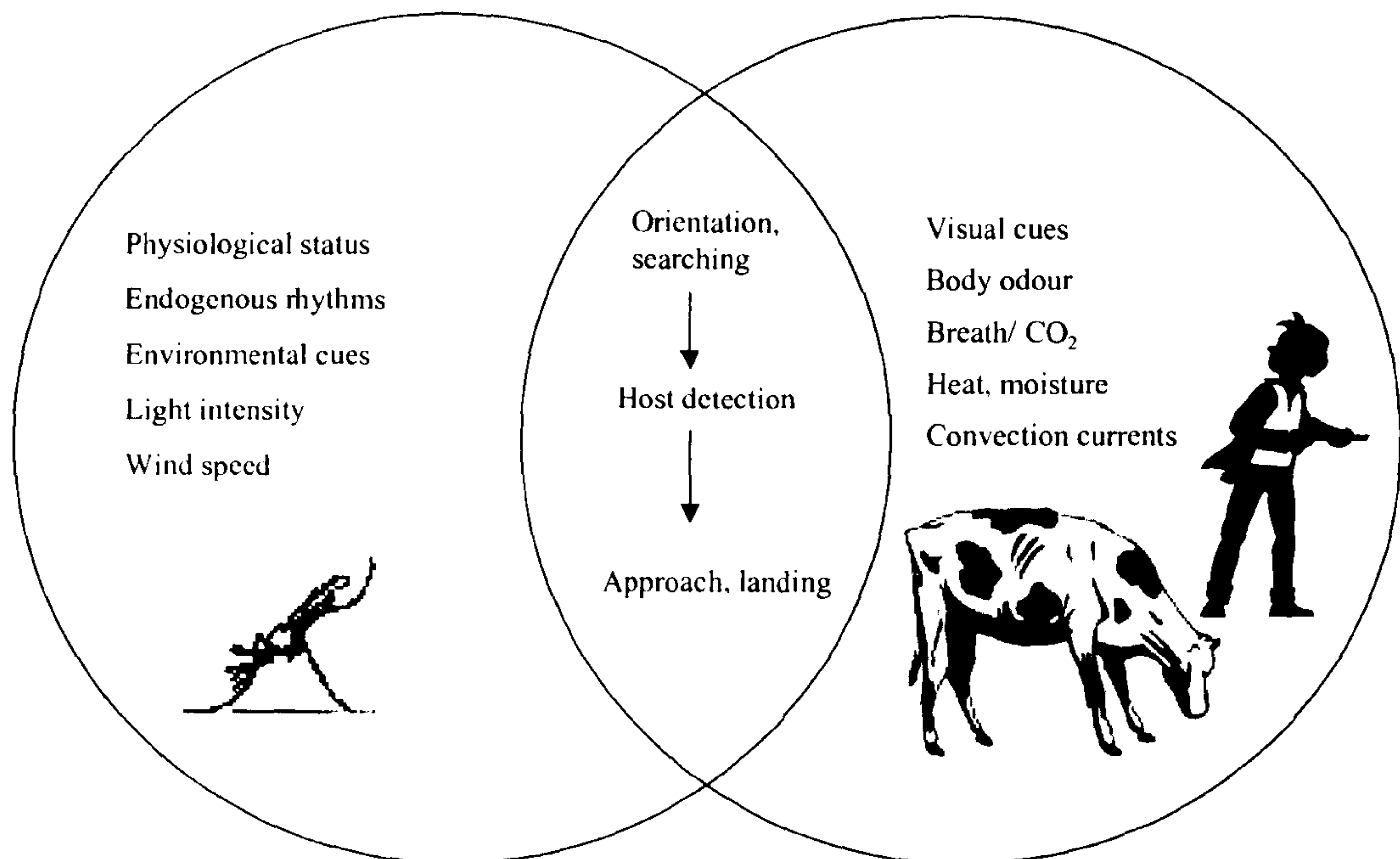

Figure 1.1. Factors contributing to the host-seeking process in mosquitoes. Mosquito-and host-factors affecting this process are shown. Feeding success is influenced by mosquito factors (such as density, persistence and infection status) and by host factors (such as species/ individual, age/ health, use of personal protection and defence mechanisms).

Receptors for olfactory stimuli in mosquitoes are located on the antennae and maxillary palpi (Clements, 1999); olfactory stimuli are produced by a potential mate, food source or oviposition substrate (Takken, 1996) and are arguably the most important group of external stimuli affecting mosquito behaviour (Takken & Knols, 1999). Air-borne olfactory cues produced by the host (e.g. exhaled air, skin emanations, and urine) are used by mosquitoes during the host-seeking process to orient themselves toward that host (Takken, 1991).

Mosquitoes encounter complex odour blends in nature and consequently single compounds are rarely as attractive as mixtures, both in the field and in the laboratory. Lactic acid has been shown to be attractive to *Ae. aegypti* (Acree *et al.*, 1968; Bar-Zeev *et al.*, 1977; Smith *et al.*, 1970; Geier & Boeckh, 1999), although synergism between lactic acid and ammonia and between lactic acid and carbon dioxide has also been reported (Geier *et al.*, 1999). Experiments in a dual port olfactometer have shown that *An. gambiae* s.s. is attracted to ammonia (Braks, 1999). Octenol is capable of attracting certain species

of mosquitoes (e.g. *Ae. taeniorhynchus*) when tested alone, but is more effective when combined with carbon dioxide (Takken & Kline, 1989; Van Essen *et al.*, 1994). Carbon dioxide combined with octenol and released at cow-breath equivalent concentrations has been shown to be attractive for *An. stephensi* (a zoophilic species) but not for *An. gambiae s.s.* (Takken *et al.*, 1997). Carbon dioxide is an important stimulus that is emitted by all potential hosts. The role carbon dioxide plays in the host-seeking process is not completely understood, but the general consensus of opinion (Gillies, 1980; Mboera & Takken, 1997; Gibson & Torr, 1999) is that it has an activating effect on anthropophilic mosquitoes such as *An. gambiae s.s.* and plays a major role in the host seeking of zoophilic mosquitoes such as *An. quadriannulatus*. Carbon dioxide activates tsetse flies and affects upwind anemotaxis and alighting behaviour and in combination with acetone, carbon dioxide largely eliminates colour discrimination (Willemse & Takken, 1994).

Snow (1983) used a variety of traps with different baits (chickens, ducks, pigeons, a calf, a goat and a human) to catch host seeking mosquitoes in the Gambia and found that three categories of mosquitoes were caught; those caught mainly or exclusively in traps baited with mammals (*Anopheles* spp., *Aedes* spp., *Culex tritaeniorhynchus*); those caught almost exclusively with avian baits (*Culex invidiosus*, *Culex neavei*, *Culex tigripes* and *Culex weschei*); and one species that responded to all baits (*Culex thalassius*). In South Africa, Dekker & Takken (1998) caught significantly more *An. quadriannulatus* in traps baited with a calf or carbon dioxide than in traps baited with a human. Cow or goat baited traps have also been used in Zimbabwe to selectively trap zoophilic *An. quadriannulatus* (Mpofu *et al.*, 1993).

In tsetse flies, host selection does not appear to be as rigid since the selected removal of “preferred” host species produced no drastic effect on the abundance or nutritional state of the fly population (Vale & Cumming, 1976). Studies by Vale (1974, 1977) showed that host weight and not species was important in determining long range responses. However, tsetse flies are able to distinguish host species on the basis of species-specific olfactory cues as demonstrated by the fact that some species are more repellent (humans) or attractive (pigs) than their weights would predict (Willemse & Takken, 1994). Catches with tsetse flies were improved by using electrocuting devices to avoid the intrusion of observers, and to provide an objective evaluation of the effectiveness of traps and handnets (Vale, 1993). Catches from each of a variety of baits were assessed; when humans were absent, catches doubled for male *G. m. morsitans*, increased about four times for female *G. m. morsitans* and male *G. pallidipes*, and

increased up to ten-fold for female *G. pallidipes* (Vale, 1993). However, subsequent experiments revealed that the repellence of humans was attributed to their upright form and to odours from their skin, whereas the movements of humans and the odours of their breath were powerfully attractive (Vale, 1993). Stationary baits used with the absence of humans but with an odour attractant were then developed and hence it was necessary to identify the effective component(s) of host odour, to allow its artificial production (Vale, 1993). Blue traps or black with blue were found to be the most effective and a variety of attractants were also identified, including carbon dioxide, acetone, 1-octen-3-ol, 4-methyl phenol and 3-n-propyl phenol (Vale, 1993).

It has long been known that different mosquito species show differential degrees of attractiveness to human hosts in the field (Haddow, 1942; Muirhead-Thomson, 1951; Thomas, 1951; Brouwer, 1960; Carnevale *et al.*, 1978; Lindsay *et al.*, 1993; Knols *et al.*, 1995 a & b; Brady *et al.*, 1997; Lindsay *et al.*, 2000). De Jong & Knols (1995a) demonstrated preferences for the head and foot region of the body with *An. atroparvus* and *An. gambiae s.s.* respectively, and found a correlation between these preferences and certain combinations of eccrine sweat gland density and skin temperature. Removing exhaled breath and washing feet changed the biting site distribution. Jeganathan (1997) also observed that *An. gambiae s.s.* changed from primarily biting the feet to randomly biting anywhere on the body after feet were washed with an anti-bacterial soap. However, a study by Dekker *et al.* (1998) did not demonstrate a change in biting site preference with *An. gambiae s.s.* when feet were washed. This study concluded that near-host orientation of *An. gambiae s.s.*, *An. arabiensis* and *An. quadrimaculatus* took place merely because of convection currents along the host. It seems possible that the differences between the results of Dekker and of the two previously reported studies may also be due to individual differences between the test subjects used.

A variety of species, such as *Ae. aegypti* (Willis, 1948; Mayer & James, 1969), *An. quadrimaculatus* (Willis, 1948), *An. atroparvus* (Laarman, 1955) and *An. stephensi* (Brouwer, 1960) have been shown to be attracted to human skin emanations in the laboratory. Human sweat extract (Braks *et al.* 1997) and skin emanations from a human hand (Takken & Knols, 1990) attract *An. gambiae s.s.* in the laboratory and whole human body odour has been shown to be important for attracting *An. gambiae s.l.* in the field (Costantini *et al.*, 1996; Mboera *et al.*, 1997).

It has long been established that the presence of specific chromosomal inversions in the *An. gambiae* complex is correlated with certain behavioural characteristics. Both *An. gambiae s.s.* and *An. arabiensis* show high levels of inversion polymorphism that

seem to be related to their wide distribution and association with humans and human-made breeding places (Coluzzi *et al.*, 1979). Chromosomal polymorphisms may also be correlated with the timing of the biting cycle (White, 1974a).

Evidence for the genetic basis of host preference in mosquitoes exists, although the influence of host availability on the final bloodmeal choice appears to differ greatly between species and regions. This will be discussed in section 1.3 in a review of the literature regarding host preference in mosquitoes, how it is measured and problems with sampling methods. Information regarding specific olfactory cues used by different mosquito species has been limited to this section since this will be discussed at some length in forthcoming chapters.

The original aim of this study was to assess the feasibility of transferring the genes for zoophily from *An. quadriannulatus* into *An. gambiae s.s.*; specific aims are presented in section 1.2. A description of the general materials and methods used throughout the work presented in this thesis, including details of all mosquito colonies used, the olfactometer bioassay and PCR procedure for identifying sibling species in the *An. gambiae* complex can be found in chapter 2. Preliminary olfactometer studies and a semi-field study investigating the response of *An. gambiae s.s.* and *An. quadriannulatus* to human and cow odours is presented in chapter 3. Chapter 4 describes the standardisation of the olfactometer bioassay, which was considered necessary to enable more accurate comparisons to be made between experiments, to account for differences in the odour profile of the individual (human or cow) and to verify the conclusions from chapter 3 regarding the appropriate bioassay to be used for the work described in chapter 5.

Hybridisation studies that were intended to investigate the possibility of modifying the host preference of *An. gambiae* are discussed in chapter 5. This chapter includes information on the fertility of *An. gambiae* x *An. quadriannulatus* hybrids and backcrosses to each parent and the behaviour (i.e. the odour choice) of mosquito crosses (up to and including the third backcross to each parent) in the olfactometer. A field study in Ethiopia regarding the behaviour of *An. quadriannulatus* species B is discussed in chapter 6. This study was initiated to investigate host choice in this sibling species and to attempt to establish a colony of *An. quadriannulatus* species B that could be used in further behavioural studies using the olfactometer. A brief microsatellite analysis of material from the two *An. quadriannulatus* colonies was performed to investigate the genetic variability between the laboratory stocks and wild material; this is presented in chapter 7. A short conclusion is included at the end of each section in each chapter and is

meant to be specifically relevant to the subject of that chapter. The general conclusions and a general discussion are presented in Chapter 8. All references for each chapter have been included in a single bibliography. Appendix I includes results from a microsatellite analysis of different *An. quadriannulatus* colonies performed by Dr. Steven Sinkins (University of Notre Dame, USA) and examples of the gel photographs from the PCR analysis of sibling species from the *An. gambiae* complex can be found in Appendix II.

1.2 Aims and Objectives

1.2.1 General aim

To assess the feasibility of transferring the genes for zoophily from *An. quadriannulatus* into *An. gambiae s.s.* by backcrossing.

1.2.2 Specific aims

- i) To develop a suitable bioassay with which to identify anthropophilic and zoophilic behaviour in mosquitoes of the *Anopheles gambiae* complex.
 - Investigating the response of *An. gambiae s.s.* and *An. quadriannulatus* species A to a variety of odour cues in an olfactometer.
 - Production of 'standard' odour stimuli.
- ii) To investigate the host-choice of *An. gambiae s.s.* and *An. quadriannulatus* species A in a semi-field set-up.
- iii) To investigate the host-preference of *An. quadriannulatus* species B.
- iv) To breed *An. gambiae s.s.* x *An. quadriannulatus* hybrids and successive backcrosses to both parents.
- v) To investigate the genetics of host-preference by testing progeny from crosses and backcrosses in the olfactometer and selectively breeding the zoophilic responders.

1.3 Determination of mosquito host preference

1.3.1 Introduction

The work presented in this thesis represents an investigation into the host preference of *Anopheles gambiae sensu stricto*, the most important malaria vector in Africa, and its sibling species, *Anopheles quadriannulatus*. The high vectorial capacity of *An. gambiae s.s.* is a direct result of the feeding behaviour of this species as it feeds almost exclusively on humans. In contrast, *Anopheles quadriannulatus* is considered a medically unimportant species because it feeds mainly on bovids (White, 1974a; Coetzee *et al.*, 2000) and therefore is not a vector of human malaria. Host loyalty tends to promote the persistence of most vector borne diseases (Hasibeder & Dye, 1988) e.g. anthroponotic diseases such as malaria. This section will review the literature regarding host preference in mosquitoes, focussing on problems relating to sampling techniques used in the field to calculate the human blood index, which indirectly provides a measure of host preference. The impact that animal feeding has on malaria, behavioural diversity in species complexes and evidence regarding the genetic control of host preference is also discussed.

1.3.2 The human blood index as a measure of host preference

There is an important distinction to be made between the mosquito's selection of hosts in a given situation and its host preference spectrum (Bruce-Chwatt *et al.*, 1966). The host preference of a particular mosquito is an intrinsic physiological characteristic that can be measured experimentally using olfactometers in the laboratory or with animal baits in the field. Boreham & Garrett-Jones (1973) defined host preference as "the choice of a particular vertebrate, as a food source, rather than other species equally available". Host selection concerns the pattern of bloodfeeding in nature. This is demonstrated by the relative frequency of blood of different types observed in specific bloodmeal samples from a mosquito population at a defined place (locality or biotype) and period (Boreham & Garrett-Jones, 1973). Host selection patterns depend on the intrinsic host preference of the mosquito but may also be affected by external factors such as host availability, climate, the presence of insecticides or methods of personal protection and host defence mechanisms.

The identification of bloodmeals from wild caught mosquitoes can be used to determine the host preference of a species but is subject to a considerable degree of sampling bias. The human blood index (HBI) or anthropophilic index is often quoted as a

measure of the degree of contact between mosquitoes and humans. Garrett-Jones *et al.* (1980) defined the HBI as “the proportion of feeds taken on humans by members of a specific and specified mosquito population, expressing the degree of mosquito biting contact exhibited by that population”. Resting catches may be subject to sampling bias because mosquitoes may not remain at the feeding site after the bloodmeal and not all available resting places may be searched. A large part of the population may also die before morning (e.g. with the use of residual insecticides) so that the daytime resting population is no longer representative of the night-time biting population (Garrett-Jones, 1964; Mnzava *et al.*, 1995). Changes in the host availability such as humans sleeping outdoors (Bruce-Chwatt *et al.*, 1966) or the presence of a transient camp of nomadic herdsman with a high cattle: human ratio (Coluzzi, 1972; White & Rosen, 1973) may also cause dramatic changes in the HBI. Hence, when sampling to estimate the HBI of a mosquito population, a biotype (i.e. specific resting site) should only be disregarded when it has been shown to harbour no significant part of the blood fed population (Garrett-Jones *et al.*, 1980).

Sharp and Le Sueur (1997) suggested that the proportion of human meals taken by *An. arabiensis* is generally higher in unsprayed areas (60-100%) than in sprayed areas (27-45%). Table 1.3.2 illustrates their results from two areas of KwaZulu Natal, one sprayed with DDT and one not sprayed. *Anopheles arabiensis* is apparently exophilic (i.e. outdoor resting) in both areas, yet exit traps were only used in the DDT sprayed area. Furthermore, the majority of catches performed in the sprayed area were in close proximity to a cattle kraal, therefore the lower proportion of human bloodmeals from the sprayed area is not surprising. Moreover, Coluzzi *et al.* (1972) collected indoor resting *An. arabiensis* from human habitations in a village and from a nomadic camp of herdsman settled near the village in an unsprayed area of northern Nigeria. Approximately 83% of bloodmeals from the village and 30% from the camp were identified as human in origin. Likewise, in a sprayed area of Kaduna, Nigeria, White and Rosen (1973) found 100% and 39% human bloodmeals from a village and from a nearby nomadic camp of herdsman, respectively. In fact, the HBI calculated for these two examples are very similar (and the unweighted HBI (see below for explanation) is even higher in the sprayed area than in the unsprayed area). Hence, the HBI is clearly affected by many factors (e.g. host availability and sampling site) and the presence of insecticide in an area may not always lead to a reduction in the overall HBI.

However, there are some examples where residual house spraying has been shown to have an effect on the HBI of the target population. DDT spraying in Greece in the

1950's resulted in a dramatic reduction in the HBI of *An. sacharovi* from 0.34 (pre-spray levels) to 0.07-0.06 (under treatment levels) (Boreham & Garrett-Jones, 1973). The HBI remained at low levels up to 5 years post-treatment and the reduction in the proportion of human bloodfed mosquitoes was most marked in samples collected indoors. If DDT irritation had led to an exodus of mosquitoes to outdoor biotypes, then the proportion of human fed mosquitoes outdoors would have increased, yet this did not happen. Hence, *An. sacharovi* expressed increased levels of zoophily in the presence of DDT. This change was selected out after the DDT residues disappeared. Mnzava *et al.* (1995) observed the irritability effect of DDT on *An. arabiensis* in Tanzania, resulting in an increase in the proportion of human bloodmeals from outdoor biotypes and even an increase in the overall HBI (see table 1.3.2). However in a lambda-cyhalothrin sprayed area, the proportion of human bloodmeals from both biotypes (human habitations and outdoor resting sites) decreased.

In Kenya, Bøgh *et al.* (1998) found that the introduction of impregnated bednets was associated with a 97% relative reduction of indoor-resting *An. funestus* without a corresponding increase in the number resting indoors, but with a much higher proportion of indoor and outdoor resting *An. funestus* feeding on animals. Therefore the treated nets caused a decrease in the HBI because *An. funestus* mosquitoes were diverted from feeding on humans to mainly on ruminants or birds. A similar trend was observed with *Cx. quinquefasciatus* in this study, as a marked shift from anthropophagy to ornithophagy was observed. However the treated bednets did not decrease the number of indoor resting *Cx. quinquefasciatus* because this species is less susceptible to permethrin than anophelines.

Garrett-Jones (1964) proposed a method of recalculating the HBI, since a crude mean proportion of the whole sample found to contain human blood is often a weighted mean in favour of the type of resting place from which the largest sample was collected. This 'weighted' mean may be a true representation of the HBI, if the majority of the mosquito population is found resting in that site. However, if human blood fed mosquitoes are found resting in other sites, they should be included in the estimation of the overall HBI for that population. Magesa *et al.* (1991) sampled *An. gambiae s.s.* from pit traps in Tanzania and found that HBI remained high, both before and after the introduction of insecticide impregnated nets. The 'unweighted' mean as proposed by Garrett-Jones (1964) is calculated by first dividing the bloodmeals into those collected from human dwellings (where humans are presumed to be the sole, or main, host available) and those collected from other sites (where the mosquito may have had a

choice between human or non-human blood). The percentage of human positive bloodmeals in each biotype is then summed and divided by 2 to give the unweighted mean HBI; this gives equal weight to both biotypes (locality), irrespective of the relative densities of resting mosquitoes found in each biotype (locality).

The unweighted mean HBI of a variety of mosquito species has been calculated in tables 1.4.1 and 1.4.2. in order to emphasise the problems of sampling bias and how the weighted mean HBI can either overestimate the overall HBI or, more importantly, underestimate it. A weighted mean HBI that is much higher than the unweighted mean HBI is generally a reflection of a low proportion of human bloodmeals taken in other biotypes. The HBI can be underestimated because of not including mixed meals (i.e. meals that include blood from more than one host species) or inadequate sampling. Boreham and Garrett-Jones (1973) specifically tested for mixed meals in bloodfed *An. sacharovi* collected in Greece and found 8.9% (n=1025) were of mixed origin. Sampling from the same area the following year revealed only 0.1% mixed feeds. The high percentage of mixed feeds originally found was attributed to the fact that they were specifically tested for (most bloodmeals are not tested further once a positive reaction has been obtained). However, other authors have also found high proportions of mixed feeds in different species (e.g. Lemasson *et al.*, 1997; Lochouarn *et al.*, 1998).

An alternative to the use of the unweighted mean to estimate the HBI of a population is the use of a simple model proposed by Garrett-Jones *et al.* (1980) based on the following elements:

- The prevalence of biotypes (e.g. the number of human dwellings and the number of cattle sheds).
- The density of fed mosquitoes (e.g. the number of fed vectors per human dwelling and the number of fed vectors per cattle shed).
- The distribution of bloodfed mosquitoes (e.g. the size of the fed population in human dwellings and the size of the fed population in cattle sheds).
- The human-fed index (e.g. the proportion of human fed mosquitoes found in human dwellings and cattle sheds).
- The distribution of human fed mosquitoes (e.g. the size of the human fed population in human dwellings and in cattle sheds).

The model is theoretically simple but difficult to apply in practice since it may not be possible to sample all biotypes or all mosquitoes in certain biotypes. This would not be practical where the main vector is exophilic and may rest amongst vegetation and various

other ill defined outdoor sites or in areas where there is more than one vector species present.

Another factor affecting the HBI, not yet mentioned is host defensiveness. Density-dependent host defensiveness appears to be the major host-related determinant of lifetime reproductive success for blood-sucking insects, affecting the quantity of blood ingested and the probability that the vector lives to feed again; hence there must be intense pressure for vectors to evolve strategies to discriminate and feed on the least defensive hosts (Kelly, 2001). Some host preferences may be learnt through experience (see section 1.3.6), although more studies are required before this can be confirmed. Some host cues may indicate the quality of a host as a blood source, for example ketones could allow insects to select malnourished or diseased individuals, which are likely to be more passive; attraction to lactic acid could serve as a marker for physical exhaustion; heat and humidity may be associated with increases in fever hence host lassitude (Kelly, 2001). Torr *et al.* (2001) showed that the less defensive the host, the more the host is bitten. Therefore defensive behaviour may be very important in determining the degree of opportunism exhibited by certain mosquito species and hence the resulting HBI.

Table 1.3.1. The proportion of human bloodmeals identified in a variety of anophelines. The Human Blood Index (HBI) has been calculated for each example as the weighted mean and unweighted mean where possible (see section 1.3.2 for full explanation & end of table 1.3.2 for explanations ^{1,2,3 & 4}).

<i>Anopheles</i> spp.	Region/ Country	Insecticide use	Collection method ¹	% positive human bloodmeals (& number tested)			Remarks	Reference
				Human ² habitations	Other ³ resting places	HBI weighted mean /unweighted mean ⁴		
<i>culicifacies</i> s.l.	Punjab, Pakistan	Not for 14 years	IRC	5.6% (36)	0.43% (1847)	0.005 / 0.03	>90% feeds bovine	Reisen & Boreham (1979)
<i>stephensi</i>	Punjab, Pakistan	Not for 14 years	IRC	0% (73)	0% (744)	0.00 / -	>95% feeds bovine	
<i>fluviatilis</i> s.l.	Punjab, Pakistan	Not for 14 years	IRC	-	1% (95)	0.01 / -	>89% feeds bovine	
	Orissa state, India	Not stated	IRC	72.7% (22)	16% (100)	0.26 / 0.443	67% feeds bovine	Gunasekaran <i>et al.</i> (1994)
<i>fluviatilis</i> species S	Orissa state, India	Not stated	IRC	86.5% (156)		0.865 / -	3% feeds bovine, 4% mixed feeds	Nanda <i>et al.</i> (1996)
<i>fluviatilis</i> species T	Uttar Pradesh state, India	Not stated	IRC	0.18% (567)		0.018 / -	95% feeds bovine	
<i>sacharovi</i>	Greece (1970)	DDT (1950's)	IRC	42.3% (260)	1.3% (761)	0.12 / 0.218	Most feeds from sheep and/or goats	Boreham & Garrett-Jones (1973)
	Greece (1971)	DDT (1950's)	IRC	61.2% (1261)	0.9% (537)	0.43 / 0.31		
<i>vestipennis</i>	Lacandón Forest, Mexico	Not stated	unknown	-	-	0.46 / -	Quoted in Arredondo-Jiménez <i>et al.</i> (1996)	
	Coastal Plain, Mexico	Not stated	unknown	-	-	0.07 / -		
<i>pharoensis</i>	Bansang, The Gambia	Not stated	IRC (spray)	61.1% (18)	-	0.611 / -	22% feeds bovine	Snow (1987)
	Gambella, Ethiopia	Pirimiphos methyl	IRC	22.5% (436)		0.225 / -		Nigatu <i>et al.</i> (1994)

Table 1.3.1 The proportion of human bloodmeals identified in a variety of anophelines (continued).

<i>Anopheles</i> spp.	Region/ Country	Insecticide use	Collection method ¹	% positive human bloodmeals (& number tested)			Remarks	Reference
				Human ² habitations	Other ³ resting places	HBI weighted mean /unweighted mean ⁴		
<i>nili</i>	Gambella, Ethiopia	Not stated	IRC	100%	-	1	No cattle or sheep indoors, only chickens	Krafsur (1977)
				(94)	-	/ -		
<i>funestus</i>	Ifakara, Tanzania	Not stated	IRC	37.5%	(16)	0.375	Bloodmeals from human & mixed dwellings pooled	Nigatu <i>et al.</i> (1994)
				(956)	-	/ -	1.6% feeds canine, 1.2% feeds bovine	Charlwood <i>et al.</i> (1995)
	Segera, Tanzania	Not stated	IRC	97.5%	24%	0.94		White <i>et al.</i> (1972)
				(508)	(25)	/ 0.608		Mbogo <i>et al.</i> (1993)
	Kilifi, Kenya	Not stated	IRC (spray)	90.1%	-	0.90		
	Gambella, Ethiopia	Not stated	IRC	100%	-	1	Includes 1 mixed human/ goat feed	Krafsur (1977)
	Manarintsoa, Madagascar	DDT	IRC	49%	9%	0.32	65% bovine feeds from pit	Fontenille <i>et al.</i> (1990)
	Fenoarivo, Madagascar	No DDT for 50 years	IRC (spray)	87%	-	0.87	Includes 1 mixed human/ canine feed	Duchemin <i>et al.</i> (2001)
	Dielmo, Senegal	None	IRC (spray)	92.9%	-	0.93	Includes 1.8% mixed human/ bovine feeds	
	Kouvar & Sankagne, Senegal	None	IRC (spray)	74.9%	-	0.75	Includes 0.6% mixed human/ bovine feeds (22% equine)	Lochouarn <i>et al.</i> (1998)
	Kedougou Region, Senegal	None	IRC (spray)	87.0%	-	0.87	Includes 5.8% mixed human feeds	
	Wassadou, Senegal	None	IRC (spray)	33.3%	-	0.33	53% feeds from equine	

Table 1.3.2. The proportion of human bloodmeals identified from members of the *Anopheles gambiae* complex. The Human Blood Index (HBI) has been calculated for each example as the weighted mean and unweighted mean where possible (see section 1.3.2 for full explanation & end of this table for explanations^{1,2,3 & 4}).

<i>Anopheles</i> spp.	Region/ Country	Insecticide use	Collection method ¹	% positive human bloodmeals (& number tested)				Remarks	Reference
				Human ² habitations	Other ³ resting places	HBI weighted mean	HBI /unweighted mean ⁴		
<i>gambiae</i>	Gambella, Ethiopia	Pirimiphos methyl	IRC	33% (264)	-	0.33		Nigatu <i>et al.</i> (1994)	
<i>s.l.</i>	Gambella, Ethiopia	Not stated	IRC	100% (283)	-	1	Includes 2 mixed feeds	Krafsur (1977)	
	Bako, Ethiopia	None	IRC	-	0.14% (144)	0.01	Represents mixed human/ bovine feeds	Turner (1972)	
	Kilifi, Kenya	Not stated	IRC (spray)	94.7% (473)	-	0.95		Mbogo <i>et al.</i> (1993)	
	Ifakara, Tanzania	Not stated	IRC	95.7% (948)	-	0.96		Charlwood <i>et al.</i> (1995)	
	Manarintosa, Madagascar	DDT	IRC (cow shed) ORC/ pit	-	4.2% (216)	0.04 / 0.02	Data from cattle shed and ORC combined; considered to be <i>arabiensis</i> & main vector in area (sporozoite rate 0.11%)	Fontenille <i>et al.</i> (1990)	
	Natal, South Africa	DDT	IRC ORC/ pit	1.3% (75)	2% (48)	0.0163 / 0.0165	97.7% feeds bovine	Sharp <i>et al.</i> (1984)	
	Bansang, The Gambia	Not stated	IRC	91.3% (658)	-	0.91		Snow (1987)	
	Podor district, Senegal	Not stated	IRC (spray)	71.8% (117)	-	0.72	Data pooled for 3 villages over 2 years	Faye <i>et al.</i> (1997)	

Table 1.3.2. The proportion of human bloodmeals identified from members of the *Anopheles gambiae* complex (continued).

<i>Anopheles</i> spp.	Region/ Country	Insecticide use	Collection method ¹	% positive human bloodmeals (& number tested)				Remarks	Reference
				Human ² habitations	Other ³ resting places	HBI weighted mean / unweighted mean ⁴			
<i>gambiae</i> s.s.	Kisian & Saradidi, Western Kenya	None	IRC (spray)	97.3% (1054)	-	0.97	Includes 1.5% mixed human/ bovine feeds	Petrarca <i>et al.</i> (1991)	
	Kisumu, Kenya	Diethrin in 1960's	IRC (spray) Exit traps	91.7% (72)	-	0.92		Githeko <i>et al.</i> (1996)	
	Segera area, Tanzania	Not stated	IRC ORC/ pit	91.2% (1121)	2% (87)	0.85 / 0.466	Most of feeds bovine	White <i>et al.</i> (1972)	
	Jirima, Northern Nigeria	None	IRC	100% (129)	78.6% (84)	0.915 / 0.893	Other = nomadic herdsmen with camp near village & high ox: human ratio	Coluzzi <i>et al.</i> (1972) from Garrett-Jones <i>et al.</i> (1980)	
	Anguwun Maaza, Kaduna, Nigeria	OMS 1028	IRC (spray)	100% (85)	83% (50)	0.93 / 0.915	Other = nomadic camp where cattle outnumber humans	White & Rosen (1973)	
	Barkedji, Senegal	Not stated	IRC (spray)	69.7% (264)	-	0.70	Includes 7.5% mixed human/ cow or equine meals	Lemasson <i>et al.</i> (1997)	
	Ndiop, Senegal	Not stated	IRC (spray)	74.2% (89)	-	0.74	27% feeds bovine	Fontenille <i>et al.</i> (1997)	

Table 1.3.2. The proportion of human bloodmeals identified from members of the *Anopheles gambiae* complex (continued).

<i>Anopheles</i> spp.	Region/ Country	Insecticide use	Collection method ¹	% positive human bloodmeals (& number tested)				Remarks	Reference
				Human ² habitations	Other ³ resting places	HBI weighted mean / unweighted mean ⁴			
<i>arabiensis</i>	Ethiopia	Not stated	IRC	93.1% (130)	17.4% (195)	0.477 / 0.552	Other = data for cow sheds and mixed dwellings combined	Hadis <i>et al.</i> (1997)	
	Kisumu, Kenya	Diieldrin in 1960's	IRC (spray) Exit traps	18.2% (11)	-	0.18 / -		Githeko <i>et al.</i> (1996)	
	Kisian & Saradidi, Western Kenya	None	IRC (spray)	62.8% (215)	-	0.63 / -	Includes 2.8% mixed human/ bovine feeds	Petrarca <i>et al.</i> (1991)	
	Baringo district, Kenya	None	IRC ORC/ pit	63.5% (961)	4.5% (247)	0.51 / 0.34	Includes mixed human feeds; large number of cows & goats kept in sheds	Mnzava <i>et al.</i> (1994)	
	Segera area, Tanzania	Not stated	IRC ORC/ pit	60.9% (1277)	7% (87)	0.57 / 0.340		White <i>et al.</i> (1972)	
	Kikwazu, Tanzania	None	IRC ORC/ pit	86% (168)	21% (364)	0.41 / 0.535	Indoor: outdoor cattle ratio = 1:3		
	Mlebule, Tanzania	DDT	IRC ORC/ pit	52% (349)	69% (72)	0.55 / 0.605	Cattle indoors, none outdoors	Mnzava <i>et al.</i> (1995)	
	Kasiga, Tanzania	Lambda- cyhalothrin	IRC ORC/ pit	66% (157)	12% (223)	0.34 / 0.39	Indoor: outdoor cattle ratio = 1:25		
	Lower Moshi, Tanzania	Not stated	IRC	7.1% (42)	3.6% (112)	0.054 / 0.0535	Mixed meals included, cattle housed apart	McCall <i>et al.</i> (2001)	
				50.5% (95)	51.4% (74)	0.59 / 0.51	Mixed meals included, humans & animals in close proximity		

Table 1.3.2. The proportion of human bloodmeals identified from members of the *Anopheles gambiae* complex (continued).

<i>Anopheles</i> spp.	Region/ Country	Insecticide use	Collection method ¹	Human ² habitations	% positive human bloodmeals (& number tested)		Remarks	References
					Other ³ resting places	HBI weighted mean/ unweighted mean ⁴		
<i>arabiensis</i>	Mamfene, Natal, South Africa	DDT	IRC Exit traps	31.7% (142)	66.8% (154)	0.5 / 0.49	Other = exit traps	Sharp & Le Sueur (1991)
	Pelindaba, Dondota & Chuba, Natal, South Africa	None	IRC	95.5% (110)	-	0.96 / -		
	Alasora, Madagascar	DDT & Dieldrin (1949-1960)	IRC ORC	0	0% (116)	0.00 / -	94% feeds bovine	Ralisoa- Randrianasolo & Coluzzi (1987)
	Jirima, Northern Nigeria	None	IRC	82.9% (199)	30.4% (335)	0.5 / 0.567	Other = nomadic herdsmen with camp near village & high ox: human ratio	Coluzzi <i>et al.</i> (1972) from Garrett-Jones <i>et</i> <i>al.</i> (1980)
	Anguwun Maaza, Kaduna, Nigeria	OMS 1028	IRC (spray)	100% (9)	39% (36)	0.51 / 0.695	Other = nomadic camp where cattle outnumber humans	White & Rosen (1973)
	Barkedji, Senegal	Not stated	IRC (spray)	79.2% (859)	-	0.79 / -	Includes 11.6% mixed human feeds	Lemasson <i>et al.</i> (1997)
	Ndiop, Senegal	Not stated	IRC (spray)	73.8% (145)	-	0.74 / -	28% feeds bovine	Fontenille <i>et al.</i> (1997)

¹IRC 'indoor resting catch'; IRC (spray) 'indoor resting catch using insecticidal spray'; IRC 'outdoor resting catch'; ORC 'outdoor resting catch using pit shelter'. ²Houses containing humans as only available hosts. ³Resting places where humans are not only available host; including houses with both humans and animals, exit traps, animal shelters, vegetation etc. ⁴Human Blood Index is expressed (depending on data available) as a weighted mean (total number of human positive bloodmeals divided by total number of bloodmeals tested) and as an unweighted mean (sum of percentage human positive bloodmeals in each biotype divided by 2; see also section 1.3.2).

1.3.3 Zoophilism with malaria and the use of zooprophylaxis

Correct estimation of the HBI as discussed in section 1.3.2, is important because the HBI has a direct influence on malaria transmission. An anopheline has to feed twice on humans in order to be a malaria vector; once to acquire the infection and the second time to transmit the infection. Therefore, an increase in the probability of a mosquito feeding on humans causes a disproportionate increase in its vector efficiency. Most vectors associated with stable malaria are those which are strongly anthropophilic (such as *An. funestus* and *An. gambiae* s.s., see table 1.3.1 & 1.3.2). Mbogo *et al.* (1993) attributed the high incidence of severe malaria associated with extremely low vector densities in the Kilifi district of Kenya to high human feeding rates. Mosquito populations with a low HBI (e.g. HBI of less than 0.1) are usually non-vectors or vectors associated with unstable malaria. Limited malaria transmission by zoophilic species has been attributed to weight of numbers or dearth of animal hosts (White, 1982).

Sota and Mogi (1998) developed a vector population model with two bloodmeal hosts (humans and domestic animals) to study the influences of domestic animals to study the human biting rate and impact on malaria. This model suggested that the introduction of animals may decrease the human biting rate and malaria prevalence, if the mosquito population has attained its maximum level prior to the introduction of domestic animals, or if a large number of domestic animals are introduced for which the mosquitoes have a high biting efficiency. However, even if the average number of bites on humans is reduced, mosquito densities will be kept at high levels so that there is still a risk of intensive mosquito biting for some part of the human population. Sota and Mogi (1998) also point out that rearing many domestic animals may change the environmental conditions, producing more suitable breeding sites for certain mosquito species.

In the 1950's, DDT spraying was used in Demerara Estuary region of Guyana to control the anthropophilic, endophilic vector, *Anopheles darlingi*. Changes in the agricultural practices in the 1960's led to a livestock deficit and an apparent switch in the feeding behaviour of *An. aquasalis* Curry to human-feeding, which was considered responsible for the resurgence of malaria in the region (Giglioli, 1963). However, as pointed out by Hewitt *et al.* (1994), the return of malaria infected itinerant workers from gold fields and diamond mines may have contributed considerably to the outbreaks. Similarly, after the Second World War, *Anopheles messeae* in Italy was zoophilic and not associated with malaria but became an important vector in eastern Europe and the Soviet Union. Drastically reduced numbers of domestic stock because of the war were considered to have contributed to its increased anthropophily (Kettle, 1995).

Anopheles sinensis is the most common and widely distributed anopheline mosquito in China and, although it is mainly zoophilic, it plays an important role in the maintenance of low malaria endemicity in the plains of China and is the only vector in the area north of 34°N (Li & Lu, 1990). *Anopheles albimanus* is considered to be the primary malaria vector in Mexico but it is mainly exophilic and zoophilic, with very low sporozoite rates (Arredondo-Jiménez *et al.*, 1992). Reisen & Boreham (1979) reported malaria transmission in villages in the Punjab province of Pakistan by anophelines containing no, or a very low proportion of, human blood (see table 1.3.1). Bruce-Chwatt *et al.* (1966) reported a zero HBI for *An. stephensi* in Pakistan; *An. stephensi* is a well known zoophilic vector in India and Pakistan and has not yet been identified as a member of a species complex (Hewitt *et al.*, 1994; Subbarao *et al.*, 1999).

Zooprophylaxis is often quoted as a useful control method when malaria vectors are observed taking a large proportion of their blood meals from non-human hosts (for example, Kirnowordoyo & Supalin, 1986; Kenawy *et al.*, 1990; Hadis *et al.*, 1997). Hewitt *et al.* (1994) defined zooprophylaxis as “the deployment of animals, which are not reservoir hosts of a given disease, to divert blood seeking vectors from the human hosts of that disease”. The efficacy of zooprophylaxis appears to vary between regions and there is evidence to show that when the main malaria vector is essentially zoophilic (e.g. *An. stephensi* in Pakistan), mosquitoes may be diverted from feeding on bovids to feeding on humans (Hewitt *et al.*, 1994; Bouma & Rowland, 1995). Schultz (1989) found a higher biting rate indoors with *An. flavirostris*, when buffalo were placed either side of a house than when catches were performed outdoors with buffalo located near the human bait. Virtually all species collected that fed on buffalo also fed on humans, with a higher propensity to feed on humans indoors because mosquitoes were then isolated from their preferred host.

Killeen *et al.* (2001) devised a model based on availability for mosquito host-seeking behaviour and applied it to the quantitative analysis of host choice by malaria vector populations in two African communities. The authors report that the model showed that *An. gambiae s.l.* in The Gambia (reported to be 68% *An. gambiae s.s.*) was 77 times ‘more zoophilic’ than *An. gambiae s.s.* populations in Tanzania. This is not surprising since a mixed *An. gambiae s.l.* population consisting of both *An. gambiae s.s.* and *An. arabiensis* would be expected to be more zoophilic than a population consisting solely of *An. gambiae s.s.*. Furthermore, other authors have reported low proportions (55-74%) of human blood in *An. gambiae s.s.* caught in Sengambia (Lemasson *et al.*, 1997; Fontenille *et al.*, 1997; Bøgh *et al.*, 2001). The authors suggested that perhaps the

longstanding use of bednets in The Gambia had led to a decrease in human feeding and that the higher degree of zoophily in Gambian *An. gambiae s.l.* populations implied that zooprophyllaxis could be useful tool in the Gambia but not in Tanzania. Another study from The Gambia by Bøgh *et al.* (2001) showed that there were no significant differences in the feeding preference of *An. gambiae s.s.* and *An. melas* collected from homes near cattle and those without cattle. However, the presence of cattle did reduce the proportion of *An. arabiensis* mosquitoes found containing human blood from 82% to 52%. Interestingly, only about 55% of the *An. gambiae s.s.* mosquitoes caught from houses near cattle and houses without cattle were found to contain human blood, which whilst being low may also reflect the very high use of bednets in The Gambia diverting mosquitoes to feed on animals, as suggested by Killeen *et al.* (2001). Bøgh *et al.* (2001) concluded that the presence of cattle near houses conferred little, if any, protection against malaria vectors in the study area. Snow *et al.* (1998) assessed environmental and entomological risk factors involved in the development of clinical malaria in Kenyan children and found no correlation between disease outcome and the presence of domestic animals close to the household. However, in the Ethiopian highlands, where *An. arabiensis* is the main malaria vector, Ghebreyesus *et al.* (2000) found a significant correlation between malaria incidence and animals sleeping indoors with humans.

Therefore, the diversion of mosquitoes from humans to animals appears to be highly dependent on the appropriate placement of animals in relation to humans. The main malaria vector in Java, Indonesia, *Anopheles aconitus*, is a rice field breeder and highly zoophilic and exophilic. Kirnowordoyo & Supalin (1986) studied two areas of Java; one with a high malaria incidence (Wonosobo), the other with a low malaria incidence (Purworejo). Villages with different cattle:human ratios were chosen in each area; cattle sheds in Wonosobo were closed structures, integrated within the human dwelling; cattle sheds in Purworejo were open structures without walls and a roof and detached from the human dwelling. The cattle:human ratio did not play a part in determining the degree of contact of *An. aconitus* with the community. However, the distance of cattle sheds from human dwellings and the free access of mosquitoes to a blood source (due to 'open' sheds) were the determining factors controlling the degree of human/ vector contact. Therefore, cattle placement away from human dwellings in Purworejo provided a sufficient barrier to ensure that host seeking *An. aconitus* could encounter a bovid host before a human host. Conversely, in Egypt, Kenawy *et al.* (1990) concluded that *Anopheles sergenti* were less likely to feed on humans if they shared their house with their animals. Villages in three oasis areas of the western desert of Egypt were

investigated; *Anopheles sergenti* feeds mainly on large domestic mammals but is considered to contribute to low levels of *vivax* malaria in the Jiwa oasis. The other two oases examined were malaria-free. Analysis of the bloodmeals collected in the study areas revealed that 15.3% of feeds from mosquitoes collected in Jiwa were of human origin, compared to 1.3% and 2.3% in the other two areas. Animals were kept away from houses in animal sheds in Jiwa, whereas in the other two areas animals were kept inside houses at night. However, the higher proportion of human feeds in the Jiwa samples is also a result of sampling bias, since more houses occupied by humans only were sampled in Jiwa than in the other two areas. In Ethiopia, where people often keep cattle near or inside their houses, Hadis *et al.* (1997) found that the proportion of bovine bloodmeals from 'mixed dwellings' was three times higher than the proportion fed on humans. However, the proportion of *An. arabiensis* collected in each habitat (i.e. houses with human hosts only, 'mixed dwellings' and cattle sheds) was not mentioned. If the presence of cattle increased the total number of mosquitoes in the 'mixed dwelling', then the proportion of human fed mosquitoes may be similar in number to that found in houses occupied by humans only. Ignoring mixed human/bovine meals will also lead to a lower HBI in each habitat. In northern Tanzania, McCall *et al.* (2001) found that where humans and animals slept in close proximity, 22.5% and 28.4% of bloodmeals (from *An. arabiensis*) were of human or both human and bovine origin, respectively, whereas where cattle were housed away from humans, only 4.5% of bloodmeals contained human blood. It would seem that mosquitoes were more likely to be interrupted during feeding in houses where humans and animals were kept in close proximity and the authors suggest that an interruption in feeding may constitute a negative experience, leading to a subsequent choice of a different host.

In Pakistan, Bouma & Rowland (1995) found a strong correlation between humans living in close proximity to cattle, raised human biting rates and increased malaria. Hewitt *et al.* (1994) investigated this phenomenon in a refugee camp in Peshawar, where people keep animals in the same compound and often sleep close to them. The nightly human biting rate of *An. stephensi* increased by 38% in the presence of a cow and by 50% in the presence of two goats. The biting rate of culicines increased, in general, by 29% and 20% respectively. Hewitt *et al.* (1994) concluded that the more zoophilic the species, the greater the increase in the human biting rate when near livestock. Anthropophilic species (which may be vectors) appeared to be relatively unaffected by the presence of livestock. Therefore, a zoophilic vector probably caused the

increase in malaria prevalence in compounds with cattle, as observed by Bouma and Rowland (1995).

1.3.4 Divergent host preferences in members of species complexes

A species complex consists of a group of species that are morphologically similar or identical, often differing in behaviour (such as host preference or resting behaviour) and by definition do not interbreed in the wild (see table 1.1 in section 1.1). Isolating mechanisms for such sibling species (or ‘cryptic’ species) may consist of pre-mating barriers (such as ecological or habitat isolation, seasonal or temporal isolation, sexual or ethological isolation or mechanical isolation) and post-mating barriers (including hybrid inviability, hybrid sterility and hybrid breakdown) (White, 1982). Species complexes often include vector and non-vector sibling species.

The *Aedes simpsoni* complex consists of three sibling species that differ in their host preference, vector status and distribution. *Aedes simpsoni sensu stricto* is only found in South Africa and Zimbabwe and is not a vector of yellow fever; *Aedes bromeliae* occurs throughout tropical Africa, is anthropophilic and a vector of yellow fever in Central and East Africa; *Aedes lilii* also occurs throughout tropical Africa (although it is less common than *Ae. bromeliae*), is zoophilic and not a vector of yellow fever (Mukwaya *et al.*, 2000). *Aedes bromeliae* is an important yellow fever vector in Bwamba county, Uganda, where it preferentially bites humans who live in close proximity to the forest. Within the forest, *Aedes africanus* transmits yellow fever to forest monkeys, which occasionally leave the forest to raid nearby banana plantations and then act as a link between the two cycles (Mukwaya, 1974). The absence of yellow fever from most parts of Uganda has been attributed to ‘non-primatophilic’ populations of *Ae. simpsoni s.l.*, which feed on rats, primarily *Arvicanthis niloticus* (Mukwaya, 1974). Mukwaya *et al.* (2000) analysed the internal transcribed spacer regions of the ribosomal DNA from anthropophilic and zoophilic populations of *Ae. simpsoni s.l.* and used the sequence data to construct a phylogenetic tree. The tree showed strict segregation into two clades; one clade containing all the anthropophilic individuals and another containing all the non-anthropophilic individuals, indicating the presence of two distinct taxa of the complex in Uganda.

The relationship between malaria incidence in Europe and the presence of various members of the *An. maculipennis s.l.* complex was revealed from 1927 onward and the term ‘anophelism without malaria’ was adopted to refer to the absence of malaria in areas where zoophilic members of the complex occurred (Jetten & Takken, 1994). *Anopheles*

sacharovi (Eastern Mediterranean) bites humans readily and *An. atroparvus* (coastal Europe) and *An. labranchiae* (Western Mediterranean) less readily, whilst *An. beklemishevi*, *An. maculipennis s.s.* and *An. messeae* can be considered as zoophilic populations (White, 1982; Jetten & Takken, 1994).

Five known members of the *An. culicifacies* complex (A, B C, D and E) exist in India and only species B is a non-vector (Subbarao *et al.*, 1999). However, species A, C and D have only been found containing very low proportions of human blood (not exceeding 3-4%) and therefore are considered only as important vectors at high densities (Subbarao *et al.*, 1992; Subbarao *et al.*, 1999). *Anopheles culicifacies* species B and E are sympatric in Sri Lanka and share the same polytene chromosome sequence on the X chromosome and on chromosome 2, but differ in the mitotic Y chromosome; species E has been implicated as a *P. vivax* vector in Tamil Nadu (India) and Sri Lanka (Surendran *et al.*, 2000). Members of the *An. fluviatilis* complex can often be found in association with *An. culicifacies s.l.* in India. *Anopheles fluviatilis* species T and U are exclusively zoophagic, whereas species S is predominantly anthropophagic, even in areas with low cattle:human ratios (Nanda *et al.*, 1996).

The *Anopheles nili* group consists of three forms of *An. nili s.s.*: a dark winged zoophilic form, a dark winged anthropophilic form and a pale winged anthropophilic form (Congo form) and two morphologically very close species; *An. somalicus* and *An. carnevalei* (Fontenille & Lochouarn, 1999). Cytogenetic studies have shown no evidence of chromosomal differences between the presumed zoophilic population from Namibia and the human-biting population from the Congo Republic (Gillies & Coetzee, 1987). *Anopheles nili s.s.* breeds along river systems where it is often the main malaria vector species (Fontenille & Lochouarn, 1999).

Anopheles funestus s.s. is a very important malaria vector in many parts of Africa and belongs to the *Anopheles funestus* group, which consists of several species that are distinguishable at the larval stage (*An. funestus s.s.*, *An. confusus*, *An. lesoni*, *An. rivulorum* and *An. brucei*) and a sub-group consisting of four species that are indistinguishable at the larval stage but can be identified by minor morphological differences between the adults (*An. funestus s.s.*, *An. parensis*, *An. aruni*, *An. vaneedeni*) (Gillies & Coetzee, 1987). All members of this group are essentially zoophilic, with the exception of *An. funestus s.s.*; human *Plasmodia* are only found in *An. funestus* and rarely in *An. rivulorum* from Tanzania (Wilkes *et al.*, 1996). An exophilic member of the *An. funestus* sub-group exists in northern Transvaal in a region from which *An. funestus s.s.* had been almost eliminated by house-spraying (Gillies & Coetzee, 1987). Some

karyotypes have been associated with variations in anthropophily in Madagascar, although no evidence of assortative mating was obtained (Boccolini *et al.*, 1994). Large differences in the feeding patterns of indoor resting *An. funestus* from different villages in Senegal have been observed by Lochouart *et al.* (1998). A high proportion of human bloodmeals were identified from *An. funestus* collected in the village of Dielmo whereas the proportion of human meals was much lower in the village of Wassadou, Eastern Senegal (the majority of females appeared to have fed outdoors on horses) (see table 1.3.1). Both villages possessed a similar density of horses and a high availability of humans. However, the sample size in this study was too small to confirm the existence of two sympatric taxa with reproductive isolation.

The *An. gambiae s.l.* complex (introduced in section 1.1) currently consists of seven sibling species with sharp contrasts in behaviour and host preference (see table 1.1). Although both *An. gambiae s.s.* and *An. arabiensis* transmit malaria, *An. arabiensis* often exhibits more behavioural plasticity than *An. gambiae s.s.*, particularly concerning host choice (see table 1.3.2). These two sibling species are sympatric over large areas of Africa, although *An. arabiensis* tends to be concentrated in zones of lower rainfall (i.e. drier savanna areas) than *An. gambiae s.s.* (Lindsay *et al.*, 1998; Coetzee *et al.*, 2000). The most successful operations of vector control have generally been associated with regions where isolated populations of *An. gambiae s.s.* or *An. arabiensis* existed and were monomorphic, or nearly so (i.e. consisting of only one chromosomal form) (Coluzzi, 1984). Sympatric, highly polymorphic populations of *An. gambiae s.s.* and *An. arabiensis* were considered to be the cause of the failure of indoor residual house spraying to interrupt transmission in the Garki district of Nigeria (Molineaux & Gramiccia, 1980).

Anopheles quadriannulatus has been proposed as the ancestral *An. gambiae* species due to its behavioural characteristics, relict distribution, tolerance of fairly temperate conditions and its chromosome arrangement which places it 'centrally' in the complex (Coluzzi *et al.*, 1979). *Anopheles quadriannulatus* species A and B both possess the same polytene chromosome arrangement. Coetzee *et al.* (2000) consider that they occupy very different habitats, species A being associated with localities in southern Africa with a mean annual rainfall of around 700mm and species B in Ethiopia, being associated with localities with a mean annual rainfall of more than 1000mm. Studies on the host preference of both species of *An. quadriannulatus* are limited because of the observed zoophilic behaviour in the field, which has led to the opinion that this species is not a vector of malaria. Furthermore, the fact that Ethiopian *An. quadriannulatus* species B has been regarded as the same species as its southern African namesake led to the

assumption that both species share similar feeding habits and vectorial capacity (Coetzee *et al.*, 2000). However, White (1974a) recognised that *An. quadriannulatus* from Ethiopia was more endophilic than in South Africa and he observed that “some females willingly bite humans, indoors or outdoors, especially when located confusingly close to cattle”.

Anopheles quadriannulatus species A has always been associated with exclusive bovid feeding (Davidson 1964a & b, Coluzzi & Sabatini, 1968; Odetoyinbo & Davidson, 1968; White, 1974a; Coluzzi *et al.*, 1979; Coetzee & Hunt, 1985; Coetzee, 1986, 1987; Gillies & Coetzee, 1987; Ralisoa Randrianasolo & Coluzzi, 1987; Coetzee *et al.*, 1993; Dekker & Takken, 1998; Hunt *et al.*, 1998; Coetzee *et al.*, 2000; Dekker *et al.*, 2001a). No records of human positive bloodmeals recovered from resting catches of this species have been published and extensive searches (Coetzee, personal communication) have yielded no evidence of *Plasmodium* infection in *An. quadriannulatus*. However, this does not mean that *An. quadriannulatus* exists entirely without association with humans. In Zimbabwe, 43.6% of the *An. gambiae s.l.* caught in a human baited tent trap were identified as *An. quadriannulatus* whereas an ox baited trap yielded 95% *An. quadriannulatus* (Mpofu and Masendu, 1986). Mpofu *et al.* (1993) reported a majority of *An. quadriannulatus* caught in human baited net traps in late May and early June, being replaced by a majority of *An. arabiensis* after early June. Sharp *et al.* (1984) sampled indoor house and outdoor resting *An. gambiae s.l.* in Natal, South Africa and identified 98.5% of the catch as *An. quadriannulatus* (and 1.5% as *An. merus*) (see table 1.3.2). Goat baited net traps caught nearly three times as many *An. gambiae s.l.* as a man baited trap. The HBI was calculated as 0.016 and since the vast majority of the indoor resting mosquitoes had fed on cattle, mosquitoes were probably entering human habitations only to rest, not to bite. However, the specimens used for bloodmeal identification were not identified to sibling species and therefore this low HBI cannot be attributed to *An. quadriannulatus*. Hunt and Mahon (1986) identified *An. quadriannulatus* in the majority of indoor resting *An. gambiae s.l.* populations in human habitations in areas of heavily grazed open savanna in Zimbabwe and South Africa. These results suggested that where no other suitable resting sites were available, *An. quadriannulatus* would readily utilise human habitations. Dekker and Takken (1998) remarked that *An. quadriannulatus* occasionally bite humans in Komatipoort, South Africa because of the very low density of cattle and near absence of wildlife. Dekker and Takken (1998) performed experiments with a baited net trap in South Africa and showed that carbon dioxide attracted a similar number of *An. quadriannulatus* as a calf, and a calf was significantly more attractive than a man (9 caught in the calf baited trap; zero in the man

baited trap). Finally, an olfactometer study by Dekker *et al.* (2001a) showed that *An. quadriannulatus* species A was not attracted by human odour, but preferred to enter the control port.

In contrast, *An. gambiae s.s.* demonstrates a consistent close association with humans, indicated by the specific human biting and indoor resting behaviour but also by its particular sunlit larval breeding habits in unvegetated water pools (that are frequently human-made). Furthermore, *An. gambiae s.s.* may possess specific mechanisms adapted to human feeding. Pre-diuresis is the process of the concentration of host blood during feeding, which presumably benefits the mosquito because of increased nutrition and fecundity without a concurrent increase in wingload (Vaughan *et al.*, 1991). Vaughan *et al.* (1991) showed that *An. arabiensis* was heterogeneous in its propensity to undergo pre-diuresis whereas all *An. gambiae s.s.* tested underwent pre-diuresis and showed evidence of a very efficient erythrocyte filtration system (demonstrated by the passage of few red cells in the excreted fluid). Human blood is known to be less nutritious than, for example, cow blood since it contains low levels of the essential amino acid, isoleucine (Edman, 1989), which may explain why pre-diuresis is necessary in an anthropophilic species. However, Vaughan *et al.* (1991) showed that the zoophilic species *An. stephensi* underwent pre-diuresis, but the process took nearly 1.4 times longer than in *An. gambiae s.s.*, perhaps because feeding at night on a bovid is less risky for the mosquito than feeding on a human. However, *Anopheles quadriannulatus* also undergoes pre-diuresis (W. Takken, personal communication), although the process has not yet been studied in this sibling species.

The proportion of human bloodmeals found in wild-caught *An. gambiae s.s.* tends to be very high, even in areas where cattle outnumber humans (see table 1.3.2). There are two notable examples of *An. gambiae s.s.* deviating from its strict anthropophilic behaviour pattern. The first is a study by Duchemin *et al.* (2001) in Madagascar using odour baited entry traps (OBET). In total, 92 *An. gambiae s.s.* specimens were identified from the traps; 11% from the human baited trap and 89% from the cow baited trap. A similar set-up in Burkina Faso caught 1500 *An. gambiae s.s.* of which 99% were caught in the human baited trap and only 1% in the cow baited trap (Costantini *et al.*, 1998). However, *An. gambiae s.s.* was shown to be exophilic in the study area in Madagascar and the OBET may not be as efficient a tool for sampling exophilic populations as it is designed for sampling endophilic populations that can negotiate the entry ports. Nearly twice as many *An. gambiae s.l.* were caught by other methods used (Centre for Disease Control (CDC) light trap and human bait catches indoors and outdoors). In The Gambia,

Snow (1987) demonstrated a marked progressive exclusion of exophilic species with increasing wall height in pre-fabricated huts, whereas endophilic species such as *An. gambiae* remained relatively unaffected. In addition, Snow (1983) remarked that the 'Magoon' trap² deterred entry of ornithophilic species.

The second example regarding reduced anthropophilic behaviour in *An. gambiae s.s.* relates to a study by Diatta *et al.* (1998) in Dielmo, Senegal. A baited bednet trap was used outdoors and caught a total of 281 *An. gambiae s.s.*; 31% were caught in the human baited trap and 69% in the cow baited trap. This technique was used to give *An. gambiae s.l.* an equal choice of either host, rather than retrospectively using bloodfed indoor resting mosquitoes. Results from indoor and outdoor resting catches suggested that *An. gambiae s.l.* was highly endophilic in this area; therefore the use of an outdoor trap may have influenced these results. The authors conclude that the zoophily of *An. gambiae s.s.* and *An. arabiensis* may be underestimated due to selective sampling of bloodfed females in bedrooms (see section 1.3.2 for discussion of problems associated with sampling methods). Other studies from Senegal have also shown a lower proportion of human bloodmeals than elsewhere in Africa (around 70% vs. around 90%; see table 1.3.2) but these differences do not appear to be medically significant. The difference between the HBI observed in *An. gambiae s.s.* in West and East Africa may be a reflection of the host preference of different chromosomal forms of *An. gambiae s.s.* that are found in West Africa.

Gillies (1967) performed host selection experiments with *An. gambiae s.s.* and *An. merus* (the saltwater breeding sibling species from East Africa), using a calf and a man in a hut divided into two compartments with a central section for mosquito release. The *An. gambiae s.s.*, that had been previously fed on a calf showed a greater tendency to feed on the man than *An. merus*, suggesting that if any conditioning effect existed, it was limited. When the two hosts were present in the same room, the calf largely masked the presence of the man and the majority of both species fed on the calf. Under all other conditions tested, there was a consistent tendency of *An. merus* to feed on the calf and *An. gambiae s.s.* to feed on the man. Gillies (1964) also demonstrated that natural populations of *An. gambiae s.s.* show some degree of polymorphism for host preference,

² The 'Magoon' trap is a form of portable stable trap developed by Magoon in 1935. The size and construction of the trap can be adapted to suit local conditions and requirements. A typical Magoon trap is one with a base measuring 1m x 2m, with one of the two longer upright sides about 2.1m high, joined by a sloping and waterproof roof to the opposite vertical side, which is about 1.7m high. When animals such as donkeys or calves are used as bait there is no need for a floor, but unless animals such as pigs and rodents are enclosed within a cage, a floor may be necessary to prevent them from burrowing and escaping. Mosquitoes enter the trap through a horizontal slit placed about halfway up the trap, which may extend completely round the trap or be confined to the two longer sides (taken from Service, 1993).

providing the basis on which selection for behavioural changes can operate. Eggs from a highly anthropophilic population of wild caught *An. gambiae s.s.* females were used to rear females that were colour marked and released into an experimental hut with a 'calf room' and a 'man room'. Females were released, recaptured and divided into 'calf strains' and 'man strains' that were reared through the same process for several generations. Interestingly, the calf strain proved very difficult to rear, and it was difficult to get larvae in adequate numbers. Within a very few generations, it was possible to select out strains that differed significantly in feeding preference for the man or the calf. No other sibling species were involved since the two lines were crossed and hybrid males were fertile and the 'man strain' was also fully interfertile with a laboratory strain of *An. gambiae s.s.*

Anopheles arabiensis is characterised by "multiple chromosome inversion polymorphisms³ that endow this member of the *An. gambiae* complex greater ecophenotypic plasticity than is known for any other mosquito" (White, 1974a). It is for this reason that wide contrasts in behaviour have been reported, which make it difficult to summarise the behaviour of this mosquito. In general, the proportion of human bloodmeals found in *An. arabiensis* tends to be lower than that of *An. gambiae s.s.*, although this species is rarely found with an HBI as low as that already mentioned for some zoophilic vector species, such as *An. stephensi*. In some areas, (especially where *An. gambiae s.s.* is absent) *An. arabiensis* may be the main vector species. But *An. arabiensis* can survive indefinitely without human presence, as indicated by its existence in an area of the Kruger National Park, South Africa, that is uninhabited by humans (Braack *et al.*, 1994). In Madagascar, Ralisoa-Randrianasolo and Coluzzi (1987) could not find any *An. arabiensis* specimens resting indoors in bedrooms and did not find any human fed specimens in their outdoor resting catches. They concluded that this *An. arabiensis* population may be unique and represent an ancestral form of the species (although crossing experiments with continental strains of *An. arabiensis* did not demonstrate any intrinsic barriers to gene flow). Residual house spraying had taken place in the area but, in the light of the example of *An. sacharovi* already discussed, it is unlikely that such behaviour would persist more than 25 years after the end of the spraying campaign.

The house resting behaviour of *An. gambiae s.s.* and *An. arabiensis* appears to be related to optimal habitat choice since chromosomal arrangements which are frequent in

³ Chromosomal inversion = a form of mutation within the chromosome involving the reversal of a block of genes (see also chapter 8). Chromosomal inversions are common in members of the *Anopheles gambiae* complex and are used in the cytotaxonomic identification of sibling species (see table 1.2).

indoor collections tend to be those favoured by drier environments, and chromosomal arrangements more frequent in outdoor collections are those adapted to relatively more humid environments (Coluzzi *et al.*, 1979). In the Ethiopian highlands, *An. arabiensis* females with 2La and 2Rb inversion heterozygotes tend to be more endophilic and to attack later at night, when it is colder (White, 1980). Mekuria *et al.* (1982) found a correlation between the frequency of the 2Rb inversion in *An. arabiensis* and altitude. However, Lulu *et al.* (1991), also working in Ethiopia, could not find a correlation between frequencies of the 2Rb inversion and altitude but suggested that possession of the 2Rb homozygous inversion was likely to become increasingly more important at higher altitudes where the outdoor temperatures were unfavourably cool for the mosquito's survival. The highly zoophilic and exophilic populations of *An. arabiensis* in Madagascar (already mentioned) have been found carrying the fixed 2Rb arrangement (Ralisoa-Randrianasolo & Coluzzi, 1987).

Coluzzi *et al.* (1977) found a substantial similarity in the chromosomal composition of *An. arabiensis* caught on donkeys and on human bait outdoors, indicating that the 2R inversion polymorphism was not involved in anthropophilic versus zoophilic behaviour. In Kisumu, Kenya, Petrarca and Beier (1992) found a higher HBI in *An. arabiensis* individuals collected indoors with the standard 2Rb homokaryotype than in those carrying the inverted homokaryotype. However, this difference was probably due to post-feeding endophily by cow-biters and not a preference for the standard homokaryotypes to feed on humans since, like the study of Coluzzi *et al.* (1977), the relative frequency of each karyotype was similar in catches from a cow baited trap and in human bait catches. Significant differences between the distribution of bloodmeal sources found in indoor and outdoor samples of *An. arabiensis* are frequently a reflection of host availability rather than genetic variation (Coluzzi *et al.*, 1972; White & Rosen, 1973; Mnzava *et al.*, 1994; see table 1.3.2). However, variation in feeding success (and survival) between hosts appears to be greatly influenced by host defensive behaviour; sandflies, mosquitoes, horseflies, tsetse and reduvid bugs all show that the more defensive the host, the higher the probability that the insect will be interrupted before feeding or feeding to repletion (Kelly, 2001).

1.3.5 The genetics of host preference

In Uganda, Mukwaya (1977) performed studies with anthropophilic *Ae. simpsoni* s.l. from Bwamba and zoophilic *Ae. simpsoni* s.l. from Bwayise to investigate the genetics of host preference between the two strains by means of crossing experiments. Hungry

adult females were tested in a cage containing a human hand at one end and a rat at the other end, since *Ae. simpsoni s.l.* would not readily enter traps in an olfactometer (Mukwaya, 1974) and appeared to be inhibited in the enclosed chamber of a Y-tube (Mukwaya, 1976). This behaviour was attributed to the exophilic nature of this species (see also olfactometer experiments with *An. quadriannulatus* discussed in Chapters 3, 4 and 5). A higher landing rate was observed for anthropophilic/ indoor strains whereas a lower landing rate was observed for zoophilic/ outdoor strains. The crossing experiments revealed that the host choice of hybrid females resulting from a cross between the two strains was significantly different ($P < 0.01$) from the pure bred Bwayise strain (zoophilic); the landing response was reduced but mosquitoes preferred to land on the man than the rat. This showed inheritance of the response rate from the zoophilic strain in the hybrids, but not the host preference.

Due to the lack of response of *Ae. simpsoni s.l.* in the olfactometer, Mukwaya (1977) performed further crossing experiments using two strains of *Ae. aegypti*. The two strains used included a strain from Nigeria (Ilobi), which is endophagic, endophilic and anthropophilic and a strain from Kampala (type Formosus), which is exophilic, exophagic and 'weakly anthropophilic'. The behaviour of the hybrids (in the olfactometer) resulting from crosses between the Kampala and Ilobi strain was significantly different from the Kampala parent (i.e. the zoophilic parent) but not significantly different from the Ilobi parent (i.e. the anthropophilic parent). Backcrosses showed that there was no difference in the response rate and host preference in females resulting from male hybrids backcrossed to Ilobi females. However, mosquitoes tested from backcrosses resulting from hybrid males crossed with Kampala females showed a preference for the rat over the human, in the olfactometer.

Fox *et al.* (2001) have identified several candidate odour receptor (OR) proteins in *An. gambiae*. One of the cloned genes, named AgOR1, was shown to be expressed exclusively in female mosquitoes and is down-regulated in response to bloodfeeding. The authors plan to use subtractive hybridisation to prepare anthropophilic and zoophilic enriched cDNA pools from which more defined olfactory and other behavioural genes may be isolated (Zwiebel, personal communication).

1.3.6 Host choice and memory

The Japanese Encephalitis vectors *Culex tritaeniorhynchus*, *Cx. vishnui* and *Cx. gelidus* prefer feeding on cows. However, Mwandawiro *et al.* (2000) showed that some mosquitoes were attracted to a pig, and this choice of host could be reinforced as a

result of experience. There was no evidence that this trait was passed on to offspring, hence, the feeding pattern could be influenced by host availability through repeated contact with a particular host rather than being entirely controlled by inherited behaviour patterns.

In Tanzania, McCall *et al.* (2001) demonstrated that *An. arabiensis* females tended to return to the original house they were caught in, prior to the next bloodmeal (behaviour termed as “site-fidelity”). Thus it is possible that houses permitting entry for successful feeding might be “remembered” and re-visited. However, no evidence for host-fidelity was found in this study since 86% of the recaptured mosquitoes were caught on cattle, regardless of where they were first caught.

Van Thiel *et al.* (1939) found no difference between the behaviour of *An. atroparvus* caught in a pigsty and adults that had been reared from wild caught pupae. Arredondo-Jiménez *et al.* (1992) reared *An. albimanus* mosquitoes from parental females with a known host selection (i.e. from human bait or a cattle corral) and fed F₁ females on either human blood or cattle blood. Overall, 65% of the mosquitoes selected the calf and 35% selected the human; these proportions remained the same irrespective of parental origin and the type of first bloodmeal obtained indicating that learning did not occur during initial host selection. Similarly, Rawlings and Curtis (1982) found no evidence from mark-release-recapture experiments for genetic heterogeneity between individual *An. culicifacies* in tendency to bite humans rather than cattle or to rest indoors or to exit after feeding. Lines *et al.* (1986) also found no evidence for a consistent tendency for indoor or outdoor resting among *An. gambiae s.l.* females. However, Hii *et al.* (1991) found significant tendencies of *An. balabacensis* to be recaptured on the same host or at the same site at which they were originally captured.

Charlwood *et al.* (1988) found evidence for a ‘memorised’ home range in *An. farauti* females from Papua New Guinea. McCall and Eaton (2001) demonstrated a change in the odour preference of *Cx. quinquefasciatus* for different oviposition media following exposure to the odour during rearing. The change in odour preference was acquired at each generation and not inherited. However, apparent ‘larval learning’ has frequently been interpreted as arising from contact with a chemical in or on the organism at the time the adult emerges (Van Emden *et al.*, 1996). Removing pupae from the rearing medium and placing them in clean water (or a different rearing medium) should demonstrate whether the effect seen was in fact ‘olfactory memory’ or an effect that occurs at eclosion. Jaenike (1982) showed that the aversion of *Drosophila melanogaster* to peppermint oil was diminished or reversed by rearing larvae on a diet supplemented

with that scent. However, this effect could no longer be detected when larvae were washed in water before pupation.

1.3.7 Discussion

The terms anthropophilic and zoophilic behaviour are used to express the preference of a particular mosquito species for feeding on humans or non-humans, respectively. Host selection patterns in nature may be influenced not only by the innate host preference of the species, but also host availability, the presence of insecticides and possibly the influence of indoor or outdoor resting behaviour. The assessment of the host preference of a species in the wild is greatly influenced by the sampling method used and the method used to estimate the overall human blood index of a population. Zoophylaxis is a well-known method of exploiting mosquito behaviour in order to control malaria. However, it is clear that zoophylaxis can only be effective in areas where the main vector species is zoophilic and when animals are placed apart from humans, forming a 'protective barrier', rather than increasing the risk of human-vector contact.

Crossing studies with *Aedes* species have shown dominance of the anthropophilic trait and inheritance of the response rate from zoophilic species in hybrids. There is no evidence to suggest that learning influences host selection in anophelines. Identification of the genes involved in host preference using molecular methods should help to explain the anomalies and diversity observed within and among sibling species of the *Anopheles gambiae* complex. The possibility of exploiting genes for zoophily from *An. quadriannulatus* by crossing them into *An. gambiae s.s.* is partly dependent on the stability of the trait. There is evidence for polymorphism in the host choice of wild populations of *An. gambiae s.s.*, although this polymorphism is probably often masked by external factors or not expressed. Most of the published records associating *An. quadriannulatus* with humans are based on anecdotal evidence or may be due to inaccurate or incomplete identification of the *An. gambiae s.l.* sample. It is hoped that the work reported in this thesis will give further insight into the stability of the host preference trait, whilst simultaneously clarifying the innate host preference of these two sibling species.

Chapter 2

GENERAL MATERIALS & METHODS

This chapter contains only general materials and methods that have been used in sections 3.1, 3.2, 3.4, 4.1, 4.2 and chapter 5. Materials and methods that are specific to each chapter are described in the relevant section of that chapter. Mosquitoes from the colonies described below were used in chapters 3, 4 and 5; each colony was periodically checked for purity using primers specific for the intergenic spacer region (Scott *et al.* 1993, method described in section 2.6) and cytotaxonomically by analysis of polytene chromosomes by Dr. A. Della Torre (University of Rome, Italy). Results from the microsatellite analysis of specimens from the SKUQUA and SUA colonies (performed by Dr. Steven Sinkins, University of Notre Dame, USA) are given in Appendix I and from the SKUQUA and SANGQUA colony in Chapter 7. Colour marked mosquitoes were used when different species/ strains were tested together (sections 3.3, 3.4, 4.2, chapter 5). The precipitin test (Boreham & Gill, 1973) was used to identify the origin of mosquito bloodmeals in section 3.3 (performed by O.Akinpelu and G.S. Gill, London School of Hygiene & Tropical Medicine, London, UK) and chapter 6 and is described in section 2.7. Unless otherwise stated, the work took place at the Department of Entomology, Wageningen University, The Netherlands between May 1998 and June 2001.

2.1 Mosquito colonies and rearing procedures

(Department of Entomology, Wageningen University, The Netherlands)

2.1.1 *Anopheles gambiae sensu stricto* (SUA strain)

The *An. gambiae s.s.* colony originated in Liberia in 1987 and has been reared on human blood since 1988. Adult mosquitoes were kept in 30 cm cube gauze cages at $27 \pm 1^\circ\text{C}$ and 80% relative humidity, with a 12 hour scotophase consisting of a sharp transition from dark to light. Adults were provided with a 6% glucose solution and offered a bloodmeal twice weekly for 10 minutes from a human arm. A cone of damp white filter paper was provided for oviposition. Larvae were reared in plastic trays (30 x 10.5 x 8 cm) and fed daily on Tetramin® food for baby fish (Melle, Germany). Pupae were removed daily from the trays and allowed to emerge inside the adult cage.

2.1.2 *Anopheles quadriannulatus* species A (SKUQUA strain)

The colony of the SKUQUA strain of *An. quadriannulatus* species A was established from material collected between December 1995 and May 1996 from Skukuza, South Africa, and laboratory reared for 3½ years with bloodmeals from a human arm. Adults were kept in plastic buckets (width 23 cm) with a minimum height of 25 cm (required for mating) at $27 \pm 1^\circ\text{C}$ and 80% relative humidity and a 12 hour scotophase with a 30 minute dusk/dawn period to allow for mating. Adults were provided with a 6% glucose solution and offered a bloodmeal five times a week for 30 minutes from a human arm during the scotophase. At the time of rearing, this was the only successful method found that resulted in a good number of eggs. However, bloodfeeding took up to 30 minutes and females were only induced to feed by breathing into the mosquito cage (as reported by Dekker *et al.*, 2001a). A Petri dish containing soaked black filter paper overlaid with soaked white filter paper was provided for oviposition. Larvae were reared in plastic trays (30 x 10.5 x 8 cm) in demineralised water and fed daily on Tetramin® food for baby fish. Filter paper was placed around the inside of the larval trays to prevent eggs from drying out. Eggs were then washed down the sides of the tray daily as hatching can be delayed for up to eight days. Pupae were removed daily from the trays and allowed to emerge inside the adult cage. Dead larvae and adults were removed daily from the larval trays in order to keep them clean and free from decaying matter. Buckets containing adults were cleaned and the sugar water replaced once a week to minimise the risk of fungi and bacteria accumulating in the cage. This colony was terminated in September 1999.

2.1.3 *Anopheles quadriannulatus* species A (SANGQUA strain)

The colony of SANGQUA strain of *An. quadriannulatus* was established from material collected in Zimbabwe in March 1999. The offspring from wild bloodfed females and the following generations were laboratory reared on cattle blood via a membrane feeding system (Hemotek™ 5W1, Discovery workshops, Accrington, Lancs, BB5 6SZ, UK). Fresh cattle blood was used, collected weekly from a local farm (De Ossekampen, Wageningen, The Netherlands). Adults were fed daily during the scotophase for 2 hours and provided with a 6% glucose solution. All bloodfeeding equipment was handled using plastic gloves to minimise any contamination of the equipment and membranes with human odour. Adults were kept in plastic buckets (height 50 cm, width 23 cm) at $27 \pm 1^\circ\text{C}$ and 80% relative humidity with a 12 hour scotophase and a 30 minute dusk/dawn period to allow for mating.

A Petri dish containing white filter paper on black filter paper dampened with a grass infusion was provided for oviposition. The grass infusion was prepared by placing a pinch of hay in a conical flask containing approximately 500ml demineralised water. This was then left uncovered at 27°C for 10 days to mature. Larvae were reared as for the SKUQUA strain.

2.1.4 Colour marking mosquitoes

Anopheles gambiae s.s., *An. quadriannulatus*, hybrids resulting from crosses between these two sibling species and mosquitoes backcrossed to either sibling species are all morphologically identical. It was frequently necessary to test one or more mosquito strain/ species at the same time. A rapid and easy method of identification was used in the form of colour marking mosquitoes with a fluorescent powder (yellow, red or blue) (Lithos, Benelux B.V., The Netherlands). Mosquitoes were selected and placed in a cage (as shown in fig.2). This cage was then placed inside a Perspex box, and a syringe was filled with a small amount of the fluorescent powder. The powder was blown into the cage through the gauze, so that all of the mosquitoes were covered with a fine dust to a sufficient extent to glow when exposed to UV light but not so heavily dusted as to be likely to affect behaviour (Dekker *et al.*, 2001a). Mosquitoes were then placed in a fresh cage (shown in fig.2).

2.2 The Olfactometer

An olfactometer was used to study the behavioural response of teneral adult female mosquitoes to different odour stimuli (see Knols *et al.*, 1994; Braks *et al.*, 1997; Dekker *et al.*, 2001a & b). The olfactometer (fig. 2A) consisted of a transparent flight chamber (1.6 x 0.6 x 0.6 m) through which conditioned, humidified air (27 ± 0.5°C, 70 ± 5% rh) was passed. The air was drawn from outdoors and was passed through a charcoal filter, to remove all traces of organic compounds, and entered the chamber through two small ports (5 cm in diameter, horizontally aligned and 30 cm apart). The ports were connected to the upwind end of the flight chamber, which consisted of a white Trespa® board containing two circular holes, via a glass trapping device that also served to hold the odours (Knols *et al.*, 1994). The air speed was regulated to 21 ± 1 cms⁻¹ (tested at the port entry using an anemometer) and passed through a panel of mosquito gauze (mesh width 1 mm) at the downwind end. A cage containing the test mosquitoes (diameter 8 cm) was fixed to a hole in the centre of the mosquito gauze and the base of the cage opened so that mosquitoes could fly out of the cage directly into the flight chamber. The temperature

of the experimental room was maintained at $26 \pm 1^\circ\text{C}$ with a relative humidity of $55 \pm 5\%$. This ensured that a humidity gradient was maintained inside the olfactometer, which was necessary to ensure a high entry response. Nine 60 Watt light bulbs (Philips pearl) arranged in rows on the roof of the olfactometer provided conditions equivalent to moonlight (6 Lux or 5.99980 Lumens per square metre; measured using a Foot Candle/Lux Meter, Omni Controls Inc., Tampa, Fl, USA).

2.3 Preparation of odour stimuli

2.3.1 Carbon dioxide, acetone and octenol

Since the concentration of carbon dioxide exhaled by both humans and cows is 4.5%, a pre-prepared mixture of 4.5% carbon dioxide in synthetic air (Hoek-Loos, The Netherlands) was used. The carbon dioxide was pumped from a gas cylinder into a 100 L Tedlar® gas sampling bag approximately 20 hours before use. Distilled water (10 ml) was added to the bag to obtain a near saturated humidity level. The carbon dioxide was then pumped (using a membrane pump) through Teflon tubing (5 mm width) via a flowmeter (Sho-rate, Brooks instrumental B.V., The Netherlands), into the glass traps (and clean air flow) at either 230 ml min^{-1} (human equivalent) or at 1000 ml min^{-1} (cow equivalent). A 20% carbon dioxide mixture was also prepared using 20 L of 100% carbon dioxide and 80 L of clean humidified air and pumped into the glass traps and clean air flow as described above, at a rate of 230 ml min^{-1} .

Both acetone and octenol are found in cattle breath; therefore it was considered necessary to test these chemicals alone, in combination with each other or in combination with carbon dioxide. Ox breath equivalent concentrations of acetone and octenol ($120 \mu\text{g L}^{-1}$ and 5.3 ng L^{-1} respectively) were used (Takken *et al.*, 1997). The exact quantity of acetone needed to fill a 50 L gas bag with vapour was calculated as 7.6 ml and the exact quantity of octenol needed to fill a 50 L gas bag with vapour was calculated as 3 μl (the concentration of octenol in ox breath is much lower than that of acetone). These quantities were added to a gas sampling bag filled with 50 L of clean, humidified air approximately 20 hours before use. The acetone or octenol was then pumped from the gas sampling bag into the glass trap as described above at a rate of 1000 ml min^{-1} .

2.3.2 Skin emanations

Based on the known role of human foot odour in the host location of *An. gambiae* s.s. (De Jong & Knols, 1995), nylon stockings were used to collect skin emanations from

a human foot. The same human (H. V. Pates) was used to collect foot odour for each series of experiments. The stocking was worn for 24 hours and placed in a clean glass jar approximately 12 hours before use in an experiment. Approximately the same procedure was used to collect cow skin emanations except that the nylon stocking was tied around the hind leg of a cow just underneath the hock (the most convenient area to tie the stocking), for 12 hours before being placed in a clean glass jar for storage before and between experiments. During experiments 'cow' and 'human' stockings were laid flat inside the respective glass traps of the olfactometer. It was realised that the degree of attraction of mosquitoes to different humans and cows might vary due to differences in volatile emanations but it was not feasible to test more than one individual human and one individual cow throughout this series of studies. The relative attractiveness of the cow was not known, but the human (H. V. Pates) was found to have an 'average' level of attractiveness when compared with 30 other people in standardised olfactometer experiments (R. Smallegange & Yu Tong Qiu, Wageningen University, unpublished results, personal communication).

2.4 Olfactometer bioassay: experimental procedure

All experiments took place towards the end of the scotophase. Thirty 5-8 day old females, which had not been blood-fed were used in each experiment. Mosquitoes were randomly picked from their cage 15 hours before experiments began and placed in a releasing cage (diameter 8 cm) with access to tap water via damp cotton wool placed on the gauze. The sequence of odour combinations was randomised on the same test day and between days. Test stimuli were also alternated between right and left ports to rule out any positional effects. Experiments with no odours in either port tested the symmetry of the trapping system. Mosquitoes were left inside the olfactometer for a total of 20 minutes, after which they were considered to have responded to a test odour (or clean air) if they had entered a trap. Trapped mosquitoes were anaesthetised using 100% carbon dioxide and counted at the end of the experiment. Surgical gloves were worn throughout the experimental procedure to avoid contamination of any of the equipment.

2.5 Statistical analysis of olfactometer experiments

The attractiveness of a stimulus in a two-choice test was determined by the proportion of mosquitoes caught by that stimulus. These proportions were transformed into arcsines of the square roots for analysis. Differences between the total response amplitudes of treatments and differences between separate trap catches with a certain stimulus were

analysed using ANOVA and contrasted by a Tukey test. Differences within each two-choice test were analysed with a chi-square test using the total number of mosquitoes caught after six replicates (or ten replicates for certain experiments where the response was very low).

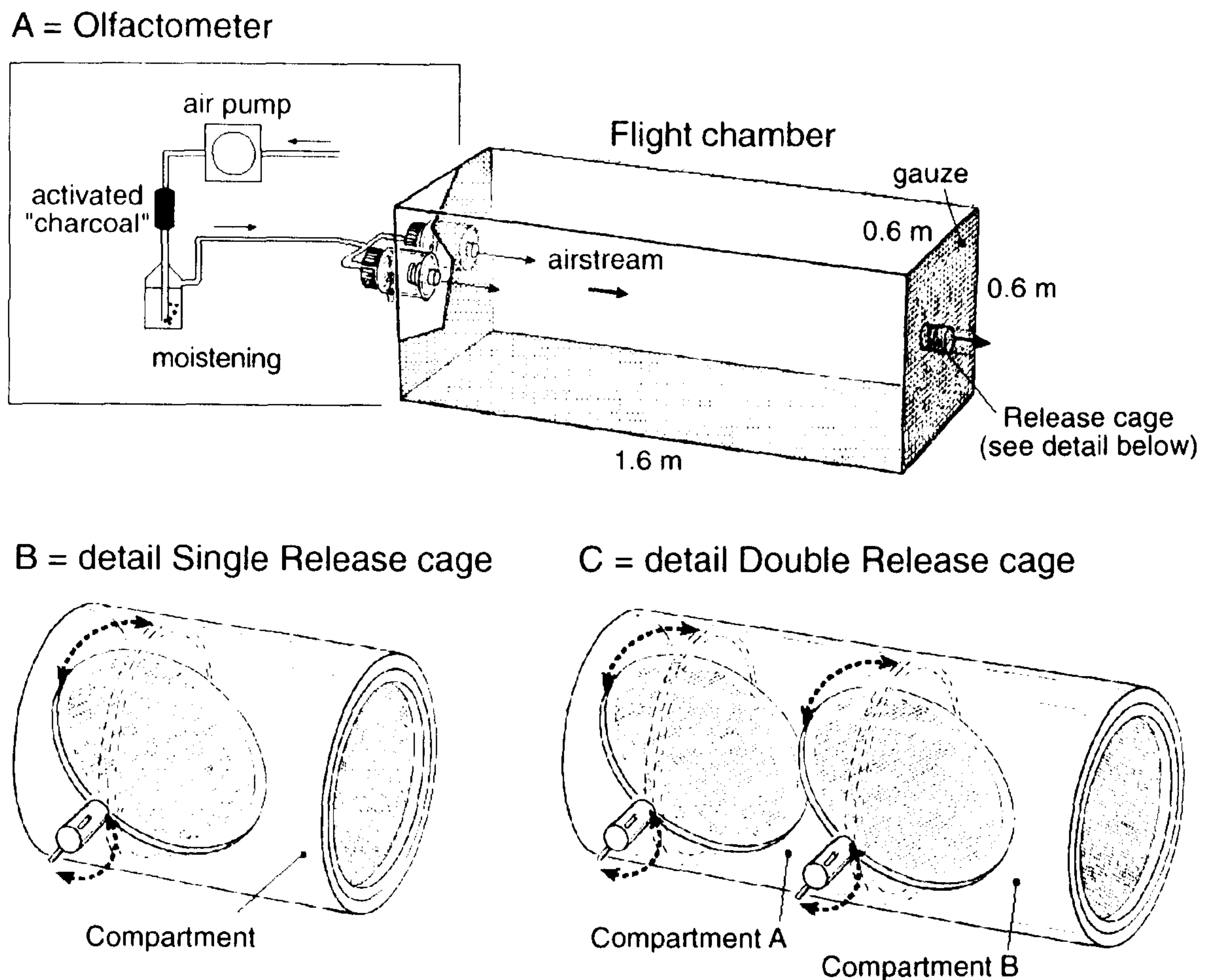

Figure 2. Diagram of the dual port olfactometer (A) and mosquito release cages (B) and (C). Air was cleaned by passing it over activated charcoal and humidified by passing it through distilled water. The clean, humidified air then passed into the glass trapping devices and out of the ports (2 ports, each 5 cm in diameter) at a rate of $21 \pm 1 \text{ cms}^{-1}$ into the flight chamber. Odour stimuli were placed inside (or pumped into) glass trapping devices (diameter 15 cm) at the upwind end of the flight chamber. Carbon dioxide (or other gases) were pumped into the glass trapping devices via an inlet spout using an aquarium pump and Teflon tubing from a gas bag. Mosquitoes were released from container (B) or (C) (diameter 8 cm) at the downwind end. Container (C) allowed two different mosquito strains/ species to be released simultaneously. Diagram courtesy of Piet Kostense, Wageningen University, The Netherlands.

2.6 Identification of members of the *Anopheles gambiae* complex using primers specific for the ribosomal DNA intergenic spacer (Scott *et al.*, 1993)

2.6.1 DNA extraction

A whole mosquito or part of a mosquito (e.g. head or abdomen) was homogenised in 50µl STE⁴. The homogenised specimens were incubated at 95°C for 12 minutes. The specimens were then centrifuged at 13,500 rpm for 4 minutes, after which the DNA supernatant was removed. The extracted DNA was either used immediately or placed in the freezer at -20°C for later use.

2.6.2 Polymerase Chain Reaction (PCR) protocol

The PCR mastermix was prepared by calculating the required amount needed of each ingredient for the total number of mosquitoes being identified (using table 2.1). The mastermix was then spun quickly, 23 µl added to a labelled eppendorf along with 2 µl of each DNA template. A negative control containing water was also included. The eppendorfs were spun quickly and then placed in the PCR machine with the following programme:

30 cycles of denaturation at 94°C for 30 seconds
 annealing at 50°C for 30 seconds
 extension at 72°C for 30 seconds

The agarose gel was prepared by mixing 1.5 g agarose with 100 ml TAE⁵ buffer and heating in a microwave for 2 minutes. Three microlitres of ethidium bromide was added to the gel before it was poured into the mould and left to set for 30 minutes. The gel was then placed in an electrophoresis tray and TAE buffer added to ensure the gel was just under the surface of the liquid. Ten microlitres of each PCR sample were mixed with 2 µl gel loading buffer and placed carefully into each well in the gel. The last well was reserved for 4 µl DNA ladder (Biozym low ladder). The gel was left to run for 1 hour at 50V/ 80-100A. Amplified fragments were then visualised by illumination with short wave ultra violet light. Examples of gel photographs can be seen in Appendix II.

⁴ 10 ml STE (DNA extraction buffer) = 20 µl EDTA (pH 8, 0.5M), 100 µl Tris HCl (pH 8, 1M), 500 µl NaCl (1M), 9.38 ml H₂O.

⁵ 50x TAE buffer = 242 g Tris base, 57.1 ml glacial acetic acid, 100 ml EDTA (pH 8, 0.5 M), ddH₂O to bring up to 1 L. Buffer diluted to 1x before use (20 ml of 50x TAE buffer + 980 ml ddH₂O).

Table 2.1. Recipe for PCR mastermix

Reagent/ primer	μ l per sample
ddH ₂ O	11.62
Buffer	2.5
dNTP's ⁶	0.5
TAQ (added last)	0.2
UN ⁷	1.2
GA	0.68
AR	2.2
M	1.5
QD	2.6
TOTAL	23
DNA template	2
TOTAL	25

2.7 The Precipitin Test for identification of bloodmeal origin (Boreham & Gill, 1973)

The precipitin test was chosen to identify the origin of bloodmeals because of supply problems with the ELISA kit at the time of the experiments. The bloodmeal (preserved and dried on filter paper) was eluted in 400 μ l PBS (see ELISA protocol in section 6.3.2 for preparation of PBS). Dried abdomens containing blood were ground in PBS using a pestle and elutions were left overnight at 4°C. The filter paper was then removed and each sample centrifuged at 5000 rpm for 5 minutes. Precipitin tubes were lined up in a test-tube rack with their corresponding bloodmeal and 200 μ l antibody⁸ was carefully added to each tube followed by 200 μ l of bloodmeal, ensuring that the antibody did not mix with the bloodmeal. Samples containing a cloudy ring precipitate (precipitate of antibody bound to antigen) after 30 minutes were recorded as positive.

⁶ Required dilution for dNTP's: A, C, G, T = 50 μ l + 300 μ l sterile H₂O = 500 μ l dNTP's.

⁷ Required dilutions for primers: UN, GA, ME & QD = 1 μ l + 99 μ l sterile H₂O; AR = 1 μ l + 69.5 μ l sterile H₂O.

⁸ Antibodies (Sigma-Aldrich Company Ltd., Gillingham, UK): anti-bovine whole serum, anti-human whole serum, anti-sheep whole serum, anti-chicken whole serum.

Chapter 3

BEHAVIOURAL RESPONSES OF *ANOPHELES GAMBIAE* & *ANOPHELES QUADRIANNULATUS* TO HUMAN & COW ODOURS

3.1 Differential behaviour of *Anopheles gambiae sensu stricto* to human and cow odours in the laboratory

3.1.1 Introduction

Until relatively recently, most of the work on host selection in *An. gambiae s.s.* has been carried out in the field (Gillies, 1967; Costantini *et al.*, 1993; Mboera *et al.*, 1997; Costantini *et al.*, 1998; Takken & Knols, 1999). More recent laboratory studies using a wind tunnel or olfactometer have demonstrated the role of human odour in the host-seeking behaviour of *Anopheles gambiae s.s.* (Takken & Knols, 1990; Knols & De Jong, 1996; Braks *et al.*, 1997). These field or laboratory studies demonstrated that host selection in *An. gambiae* is mediated by host odours and suggested that recorded host preferences are genetically fixed. In field studies, *An. gambiae s.s.* consistently exhibits a high degree of anthropophily, even when presented with odour plumes consisting of mainly cattle odour (Coluzzi *et al.*, 1975). However, from other studies this anthropophilic behaviour appears to be less rigid (Diatta *et al.*, 1998, Duchemin *et al.*, 2001). The purpose of the present study was to investigate the anthropophilic tendencies in *An. gambiae s.s.* using human and cattle odour by choice tests in an olfactometer. Both human and cattle odour was collected on nylon stockings as described in chapter 2.

3.1.2 Materials & Methods

Mosquitoes from the SUA colony described in section 2.1.1 were used in this olfactometer study (see sections 2.2- 2.5).

3.1.3 Results

The majority of mosquitoes left the releasing cage in the olfactometer and flew upwind towards the odour source (98.7% of 3660 mosquitoes tested). Any mosquitoes that were left in the releasing cage at the end of an experiment were counted and the actual number of mosquitoes released, adjusted accordingly. No mosquitoes escaped from a trap once they had entered it. There was no significant effect of day on the total catch size obtained with each experiment ($P > 0.05$). Control experiments ('no odour') showed that the olfactometer was symmetrical (i.e. there was no preference for the left or the right

port), since equal numbers of mosquitoes entered each port. The results for each trial are presented in figures 3.1.1, 3.1.2 and 3.1.3.

3.1.3.1 Response to skin emanations

The total number of mosquitoes responding to human odour baits (i.e. trapped with human odour) was significantly higher than the control (no odour vs. no odour) (fig. 3.1.1, test I). However, the total number of mosquitoes responding to cow odour (i.e. trapped with cow odour) was not significantly different from the control (fig. 3.1.1, test III). Human skin emanations from a nylon stocking which had been worn for 24 hours were highly attractive (i.e. resulted in positive ^{anemotaxis} anemotaxis) to *An. gambiae s.s.* females. Significantly more mosquitoes entered the human odour port when tested against cow odour (fig. 3.1.1, test IV & III) but there was no significant difference between the number of mosquitoes entering the cow odour port when "no odour" was the alternative choice. Significantly more mosquitoes entered the port containing the human + cow odour combination than either the no-odour or cow-odour port, i.e. the presence of the cow odour together with the human odour did not deter trap entry. There was no significant difference between the numbers choosing human odour alone or the human + cow odour combination. However, when cow odour was tested against the combined human + cow odour, significantly more mosquitoes selected the port with the combined odours.

3.1.3.2 Response to carbon dioxide

Significantly fewer mosquitoes responded (i.e. were trapped) in total in the no odour vs. carbon dioxide (human equivalent) experiment (ANOVA, $P < 0.001$) (fig. 3.1.2, test I), which is consistent with previous findings (W. Takken, unpublished). When carbon dioxide was released at human equivalent volumes (230 ml min^{-1}), significantly more mosquitoes entered the no odour port ($P < 0.05$) (fig. 3.1.2, test I). There was no effect of carbon dioxide on the response to human odour, whether the compound was released from the opposite port or in combination with human odour. When carbon dioxide was released at cow equivalent volumes (1000 ml min^{-1}), catches were almost three times higher in the no odour port compared with the carbon dioxide port ($P < 0.001$) (fig. 3.1.3, test I). However, significantly more mosquitoes entered both the no odour and carbon dioxide ports alone than the cow odour + carbon dioxide port. When human odour was tested against cow odour + carbon dioxide, significantly more mosquitoes entered the human odour port (ANOVA, $P < 0.05$) (fig. 3.1.3, test VI). The addition of carbon dioxide

to the human odour did not significantly increase the entry response, but the addition of carbon dioxide to the cow odour resulted in significantly fewer mosquitoes entering that port. In all tests (except human odour vs. cow odour + carbon dioxide (see fig. 3.1.3, test VI)) where human and cow odour were released simultaneously in the olfactometer, the addition of carbon dioxide to either stimulus did not affect the attractive effect of human odour. These results indicate that carbon dioxide may have an inhibitory effect, such that it deters trap entry.

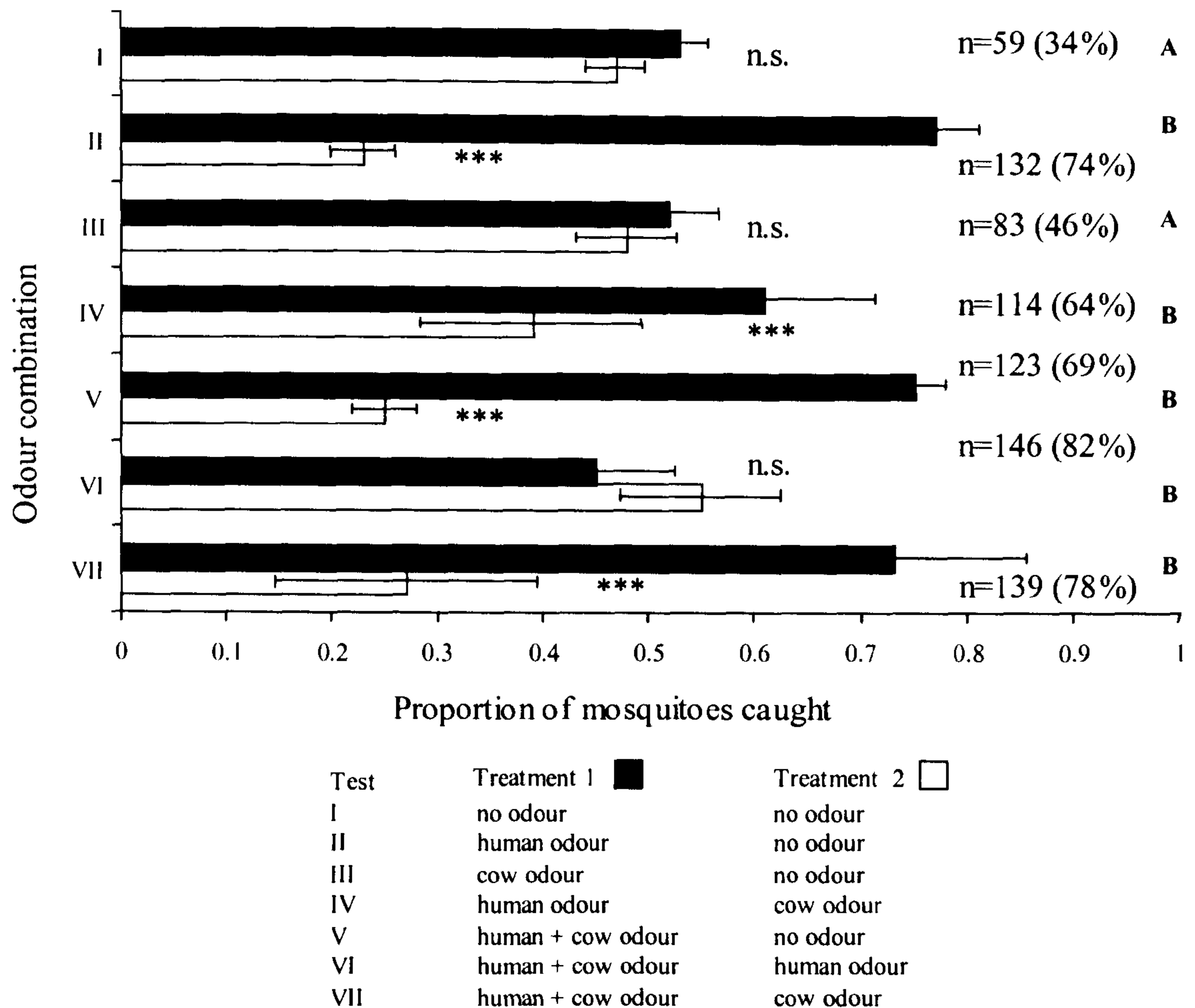

Figure 3.1.1. Catches of *Anopheles gambiae* s.s. with or without skin emanations. The total proportion of mosquitoes caught with either treatment in six replicates is shown. Asterisks mark significant differences between the total numbers trapped with treatment 1 and treatment 2 (χ^2 test: n.s.: $P > 0.05$, *** $P < 0.001$). n = total number of mosquitoes entering both traps (also expressed in parentheses as the percentage mosquitoes trapped of the total number of mosquitoes that left the release cages after six replicates). Different letters indicate significant differences in the total number of mosquitoes responding in each experiment. Error bars show 95% confidence limits. The table below the graph indicates the odour combinations tested.

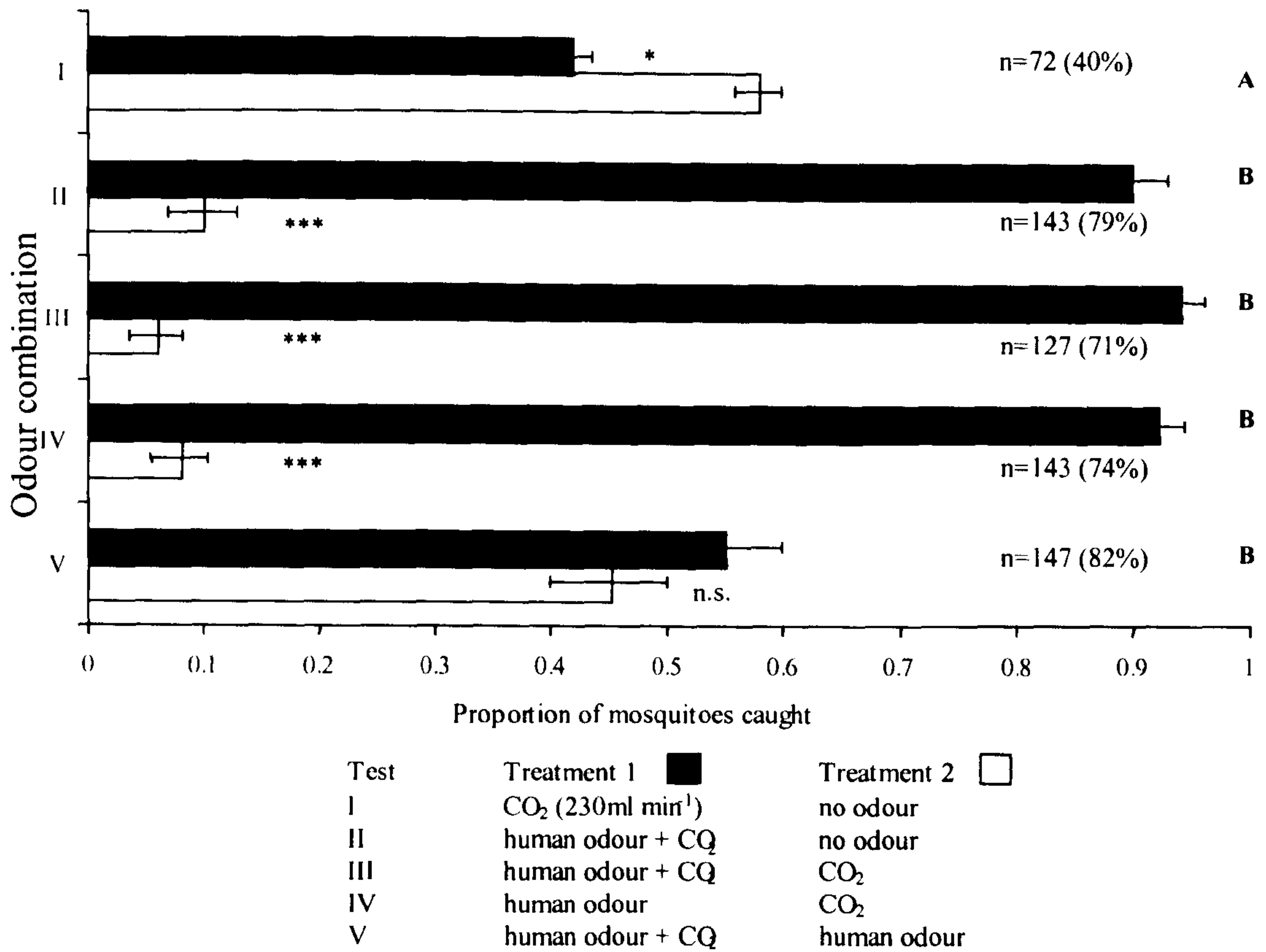

Figure 3.1.2. Catches of *Anopheles gambiae* s.s. with human equivalent volumes of carbon dioxide (4.5% delivered at 230 ml min⁻¹). (χ^2 test: n.s.: $P > 0.05$, * $P < 0.05$, *** $P < 0.001$). See fig. 3.1.1 for full explanation.

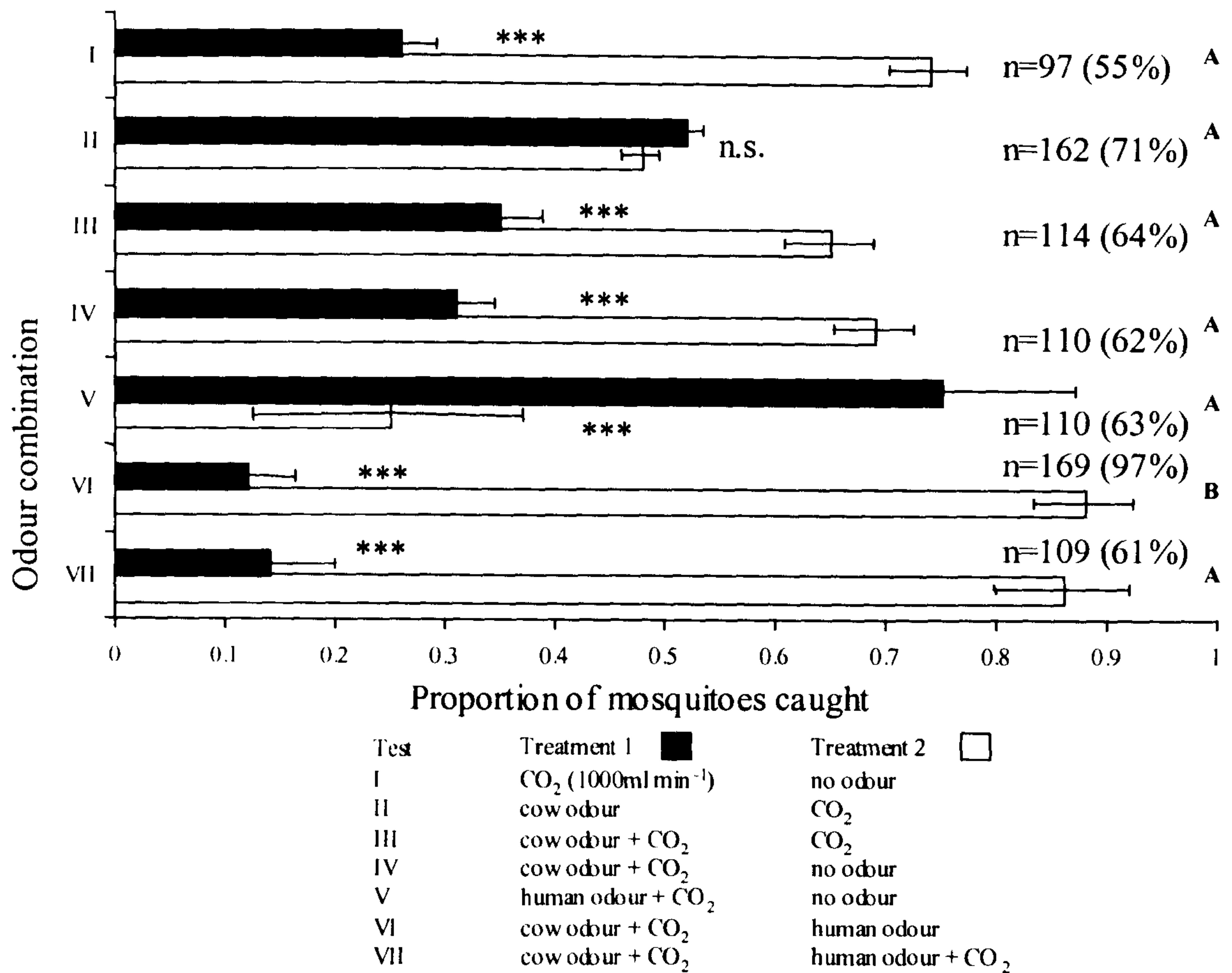

Figure 3.1.3. Catches of *Anopheles gambiae s.s.* with calf equivalent volumes of carbon dioxide (4.5% delivered at 1000 ml min⁻¹). (χ^2 test: n.s.: $P > 0.05$, *** $P < 0.001$). See fig. 3.1.1 for full explanation.

3.1.4 Discussion

These results showed that few *An. gambiae s.s.* mosquitoes were caught with cow odour whereas many mosquitoes were caught with human odour, as would be expected from a mosquito which in the field is highly anthropophilic. These results indicate consistent anthropophilic behaviour in a strain of *An. gambiae s.s.* that has been maintained in the laboratory for 11 years. Collection of human skin residues using nylon stockings was simple, proved to be a good stimulus and produced highly repeatable results. The results showed that even in the absence of odour, a considerable proportion of *An. gambiae* entered the upwind traps, a behaviour pattern which is different from *Aedes aegypti* (Linnaeus), which, under similar conditions, hardly responds to clean air (Klowden & Lea, 1978; Geier *et al.*, 1999). This behaviour of *An. gambiae s.s.* was also reported by Costantini *et al.* (2001) and may be in response to a moisture gradient.

Previous laboratory studies showed attraction of *An. gambiae s.s.* to human sweat (Braks *et al.*, 1997; Braks & Takken, 1999), human equivalent concentrations of acetone offered in combination with carbon dioxide (Takken *et al.*, 1997) and odours of non-human origin arising from the production of fatty acids by the bacteria present on Limburger cheese (Knols & De Jong, 1996). Similar fatty acids are produced by microorganisms present on the human skin and chemical analyses of the composition of Limburger cheese odour and human foot odour have shown a marked similarity (Knols *et al.*, 1997). De Jong and Knols (1995) demonstrated that *An. gambiae s.s.* preferentially bite the feet and ankles of a naked, seated motionless human host, unless the feet and ankles had been washed with an anti-bacterial soap, which significantly altered the biting site distribution. However, Dekker *et al.* (1998) demonstrated that the position of the body was important in determining biting site distribution. Various field studies have also demonstrated the attractiveness of whole human baits to *An. gambiae s.s.* (Costantini *et al.*, 1993; Knols *et al.*, 1995a; Costantini *et al.*, 1996; Mboera *et al.*, 1997).

Costantini *et al.* (1998) demonstrated the aversion of *An. gambiae s.s.* to calf odour in Burkina Faso when sampling the mosquito population using odour baited entry traps. Identification of the *An. gambiae s.l.* samples collected revealed that the human baited trap contained 52% *An. arabiensis* and 48% *An. gambiae s.s.*, whereas the calf baited trap contained 92% *An. arabiensis* and 8% *An. gambiae s.s.* In this olfactometer study, the aversion of *An. gambiae s.s.* to cattle odour was demonstrated by fewer mosquitoes in traps containing cow odour. Indeed, the presence of cow odour often led to an increase in the catch in the opposing port. However, this should not be considered as a repellent effect of the cow odour since if it were repellent, one would expect a reduction

in the number of mosquitoes entering the port containing the human + cow odour combination, yet the percentage of mosquitoes entering this port was similar to the percentage entering human odour ports (in human odour vs. no odour experiments). This suggests that the mosquito can detect human odour in the presence of cattle odour when the two stimuli are presented simultaneously and that, in the presence of human odour, *An. gambiae* is not “repelled” by cattle odour.

Anopheles gambiae s.s. did not preferentially respond to carbon dioxide offered at either human equivalent or cow equivalent volumes, and cow equivalent volumes of carbon dioxide appeared to have a more deterrent effect than the human equivalent. Carbon dioxide at cow or human equivalent volumes did not enhance the effect of human skin emanations (i.e. it did not increase the entry response (see fig. 3.1.1, test II, fig. 3.1.2, test II and fig. 3.1.3, test V)). However, carbon dioxide at cow equivalent volumes did increase the deterrent effect of cow odour. Results from olfactometer studies by Mboera *et al.* (1998) with *Culex quinquefasciatus* Say, another highly anthropophilic mosquito, observed no synergistic effect of carbon dioxide in combination with human skin emanations. De Jong and Knols (1995) tested human breath and carbon dioxide (3.56%) in a windtunnel olfactometer and found no attraction of *An. gambiae* s.s. to either stimulus. A field study by Mboera *et al.* (1997) in Tanzania caught significantly fewer mosquitoes in a tent into which carbon dioxide was pumped, than in a human odour baited tent. Costantini *et al.* (1996) also caught significantly more *An. gambiae* s.l. in human odour baited entry traps than in carbon dioxide baited traps, placed side by side.

It is considered that carbon dioxide may play an activating role causing the mosquito to engage in upwind anemotaxis, and that carbon dioxide is a more important olfactory stimulus for zoophilic species than it is for anthropophilic species (Gillies, 1980; Mboera & Takken, 1997; Takken *et al.*, 1997; Dekker & Takken, 1998). In field experiments it was found that *An. gambiae* s.s. was caught with carbon dioxide although this compound alone could never substitute for human skin emanations that appear to be more important odour cues (Costantini *et al.*, 1996). There was no significant difference in the total entry response in each experiment where carbon dioxide was used in combination with human odour, with the exception of human odour vs. cow odour + carbon dioxide (offered at calf equivalents) (fig. 3.1.3, test VI). The cow odour + carbon dioxide odour combination may have deterred mosquitoes from entering that port, resulting in an increase in the number that enter the human odour port. Recently, Dekker *et al.* (2001b) found that the turbulence of the carbon dioxide odour plume greatly affected trap entry. It was observed that homogeneously mixed carbon dioxide caused

significantly reduced entry responses, which is similar to the response seen in this study. The inhibitory effect of carbon dioxide was expressed with the compound as the only stimulus or in combination with human skin emanations. In this study, there was a similar inhibitory effect of carbon dioxide alone (fig. 3.1.2, test I, fig. 3.1.3, test I) but not when human skin emanations were present. It is assumed that carbon dioxide was released at a constant rate into the olfactometer but, as turbulence of the odour plume was not controlled, it is possible that the effect of carbon dioxide on the flight behaviour of the mosquitoes in this study may have varied between experiments. However, it is clear that, in the presence of human skin residues, there was neither an inhibitory nor an attractive effect of carbon dioxide on the entry responses of *An. gambiae s.s.*. Therefore, the role of carbon dioxide in the host-seeking behaviour of *An. gambiae s.s.* is small compared to that of other human emanations. It is concluded that host-specific olfactory cues, such as skin residues, play a major role in host identification of *An. gambiae s.s.*, whilst carbon dioxide plays a minor role.

3.2 Response of *Anopheles quadriannulatus* to human and animal odours in the laboratory

3.2.1 Introduction

Very few laboratory or field studies concerning the host-seeking behaviour of *Anopheles quadriannulatus* have been performed. This is mainly because this mosquito is considered to be completely zoophilic and hence of no medical importance (Chapter 1, Dekker & Takken, 1998; White, 1974a). In the laboratory, this zoophilic behaviour was demonstrated by Dekker *et al.* (2001a) in an olfactometer by testing the response of *An. quadriannulatus* females to human odour, cow odour and carbon dioxide. This study showed that very few mosquitoes were caught with human odour but many mosquitoes were caught in the control port. Many mosquitoes were caught with carbon dioxide (delivered at a concentration of 4.5% and rate of 230 ml min⁻¹). However, no preference for the cow odour or the control port was observed when cattle odour was tested.

The purpose of the present study was to establish the optimum odour stimulus or stimuli for *An. quadriannulatus* (SKUQUA strain) by investigating the response to a variety of odours, of both human and animal origin, in an olfactometer. The concentration of carbon dioxide in human and cattle breath is 4.5%, but the volume of carbon dioxide released by a cow is approximately 1000 ml min⁻¹, as compared with 230 ml min⁻¹ from humans. Therefore, initial experiments were carried out to assess the response of *An. quadriannulatus* to different volumes and concentrations of carbon dioxide. Acetone and octenol are also constituents of cattle breath (Hall *et al.*, 1984; Takken *et al.*, 1997); hence these chemicals were tested alone or in combination with carbon dioxide. Cow breath equivalent concentrations of acetone and octenol (120 µg L⁻¹ and 5.3 ng L⁻¹ respectively) were used (Takken *et al.*, 1997). Cow skin emanations and human skin emanations were collected on nylon stockings (see chapter 2).

3.2.2 Materials & methods

Mosquitoes from the SKUQUA colony described in section 2.1.2 were used in this olfactometer study (see section 2.2- 2.5).

3.2.3 Results

Most of the mosquitoes selected for experiments left their release cage and flew upwind towards ports (85.3% of 3054 mosquitoes tested). This proportion is lower than

the proportion of *An. gambiae s.s.* leaving the release cage (see section 3.1). The mean percentage of *An. quadriannulatus* caught in traps was also much lower than that for *An. gambiae s.s.* (24.1% vs. 66.6%). There was no effect of day on the total catch size obtained in each experiment (ANOVA, $P>0.05$) and control experiments with no odour showed that the olfactometer was symmetrical. Acetone and octenol were tested alone, against a control (clean air) but no mosquitoes responded to either stimulus (of 120 mosquitoes tested). When acetone in combination with carbon dioxide (at calf equivalents) was tested, only 2% of 120 mosquitoes responded, therefore these experiments were excluded from further analysis. Results of the other trials are presented in figs. 3.2.1 and 3.2.2.

3.2.3.1 Response to carbon dioxide and octenol

Significantly fewer mosquitoes entered traps in the control (no odour vs. no odour) and carbon dioxide delivered at cow equivalents (CO_2 ($^{4.5}/_{1000}$) vs. no odour) experiments than in all other experiments (ANOVA, $P<0.001$)(fig. 3.2.1, test I & III). There was no significant difference between the number of mosquitoes entering the port containing carbon dioxide delivered at human equivalents, at cow equivalents or at the higher concentration of 20%, when “no odour” was the alternative choice, i.e. carbon dioxide alone did not increase or decrease trap entry. However, significantly more mosquitoes entered the “no odour” port when carbon dioxide was offered in combination with octenol. These results show that carbon dioxide did not inhibit trap entry (in contrast to results with *An. gambiae s.s.* (see fig. 3.1.2 & 3.1.3)) unless combined with octenol.

3.2.3.2 Response to skin emanations

Significantly more mosquitoes entered traps in the cow odour + carbon dioxide experiment than when cow odour was tested alone (ANOVA, $P<0.001$). There was no significant difference in the number of mosquitoes entering the cow odour port when “no odour” was the alternative choice. However, in the human odour vs. no odour experiment, significantly more mosquitoes entered the human odour port ($P<0.001$; fig.3.2.2 test III). There was also no significant difference between the number of mosquitoes entering the human odour port when tested against cow odour. Significantly more mosquitoes entered the cow odour + carbon dioxide port when tested against no odour ($P<0.001$). However, significantly ($P<0.001$) more mosquitoes entered the port containing human odour when tested against cow odour + carbon dioxide.

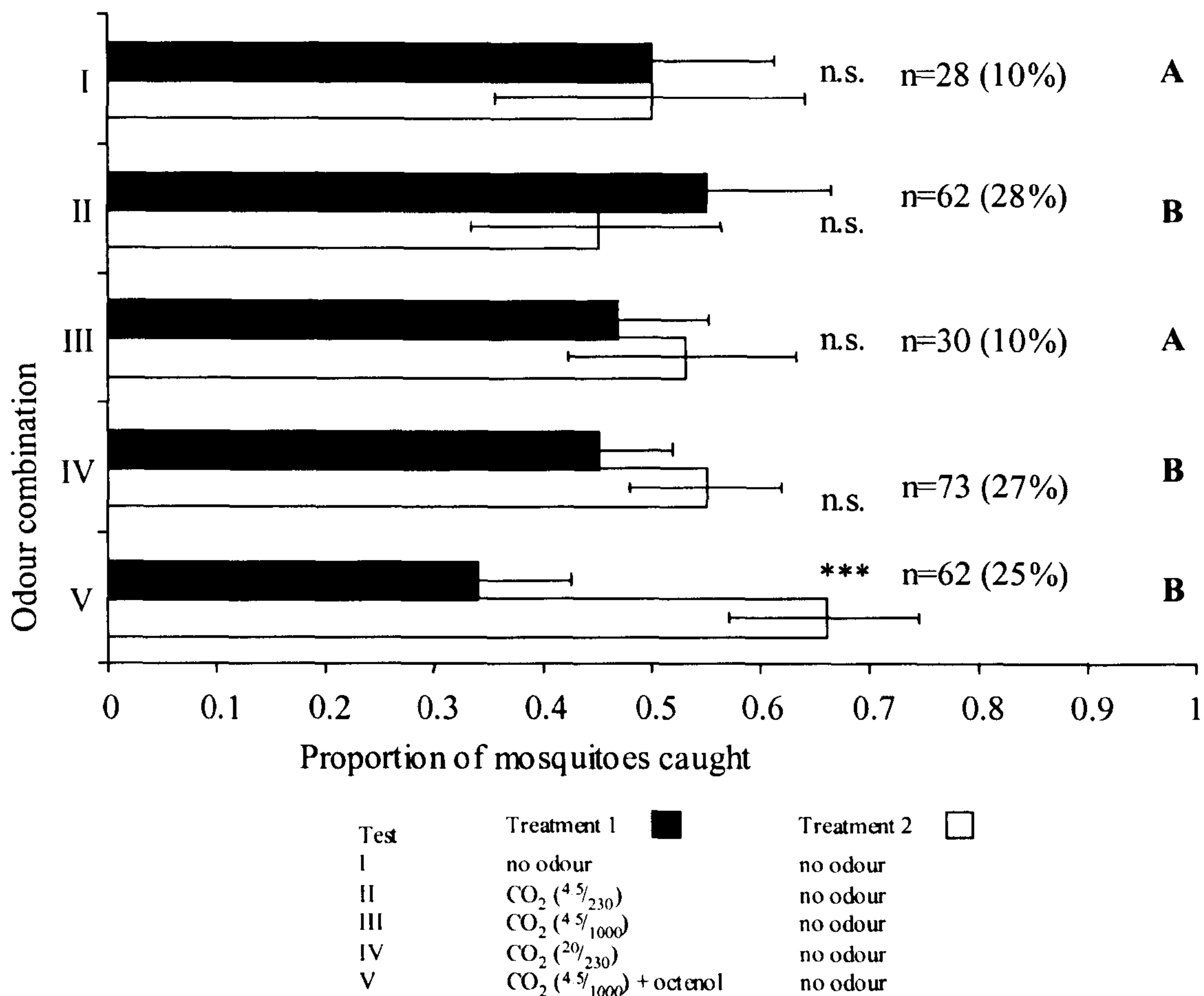
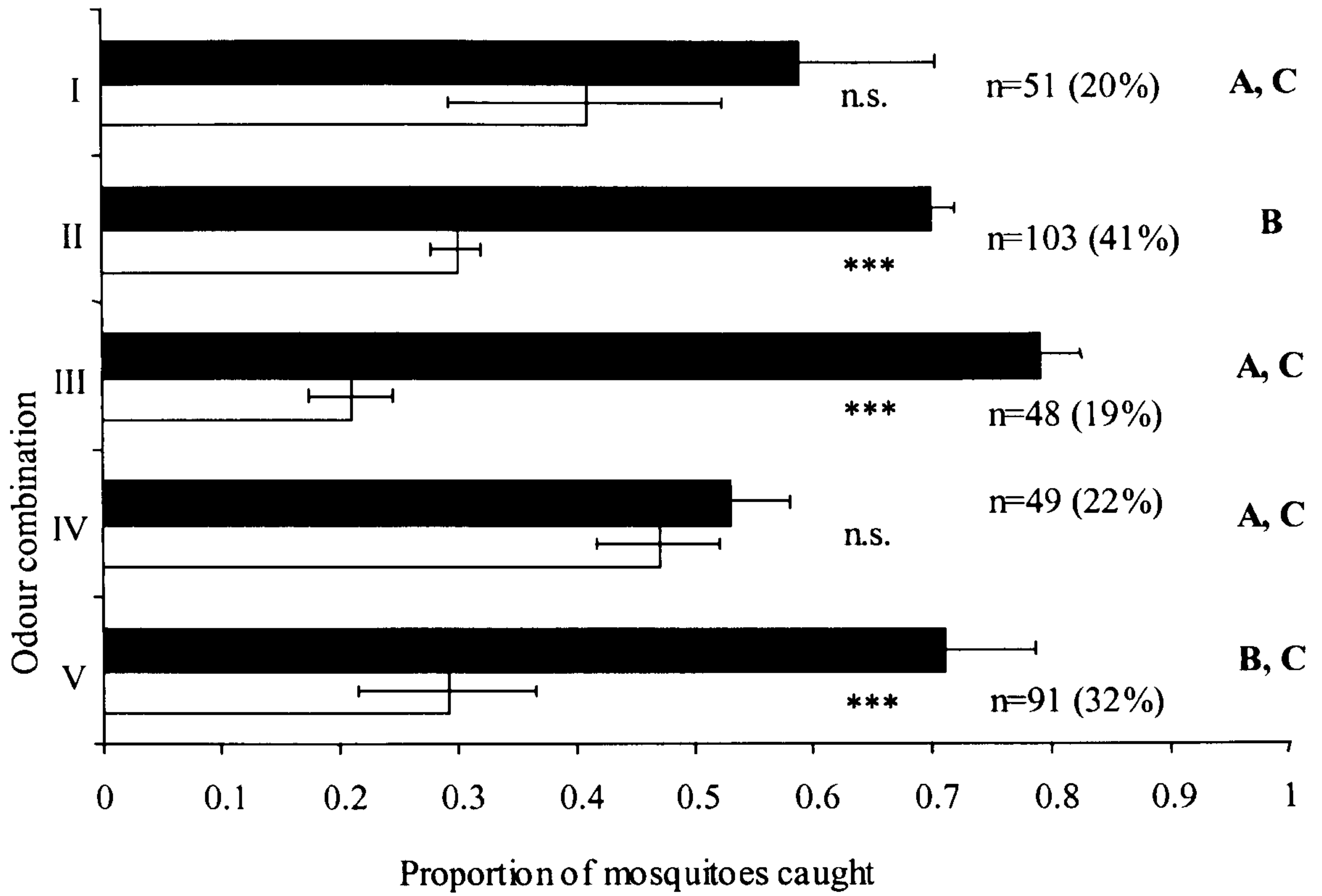

Figure 3.2.1. Catches of *An. quadriannulatus* SKUQUA strain with carbon dioxide. The total proportion of mosquitoes flying into either test port from ten replicates is shown. Asterisks mark significant differences between the total number trapped in port 1 and port 2 (χ^2 test: n.s.: $P > 0.05$, *** $P < 0.001$). n = total number of mosquitoes entering both traps (also expressed in parentheses as the percentage of mosquitoes caught out of the total number of mosquitoes leaving the release cage in ten replicate trials). Different letters indicate significant differences in the total number of mosquitoes responding in each experiment. Error bars show 95% confidence limits. The table below the graph indicates the odour combination tested; CO₂ (4.5/230) = 4.5% carbon dioxide delivered at 230 ml min⁻¹, CO₂ (4.5/1000) = 4.5% carbon dioxide delivered at 1000 ml min⁻¹, CO₂ (20/230) = 20% carbon dioxide delivered at 230 ml min⁻¹.



Test	Treatment 1	■	Treatment 2	□
I	cow odour		no odour	
II	cow odour + CO ₂ (^{4.5} /1000)		no odour	
III	human odour		no odour	
IV	human odour		cow odour	
V	human odour		cow odour + CO ₂ (^{4.5} /1000)	

Figure 3.2.2. Response of *Anopheles quadriannulatus* SKUQUA strain to skin emanations. (χ^2 test: n.s.: $P > 0.05$, *** $P < 0.001$). See fig. 3.2.1 for full explanation.

3.2.4 Discussion

The results show that carbon dioxide did not have an effect on trap entry although fewer mosquitoes were caught compared to the control when carbon dioxide was combined with octenol. Significantly more mosquitoes were caught with cow odour when it was combined with carbon dioxide, except when this odour combination was tested against human odour. The results from these experiments showed a consistently low overall response to odour stimuli offered in the olfactometer. Therefore each experiment was replicated ten times. In the absence of odour stimuli only 10% of mosquitoes leaving the release cages responded by entering either the right or left port. Under the same circumstances, more than three times as many *An. gambiae s.s.* responded by entering either port (section 3.1.3). This may reflect inherent differences in the mosquito's behaviour. In general, *An. gambiae s.s.* is endophilic whereas *An. quadriannulatus* species A is markedly exophilic, although indoor house resting *An. quadriannulatus* specimens have been recorded in southern Africa (Hunt & Mahon, 1986). *Anopheles quadriannulatus* species B in Ethiopia tends to be more endophilic, which is probably a reflection of the high altitude and low temperatures (White, 1974a). Mukwaya (1976, 1977) observed that the response of a non-anthropophilic strain of *Ae. simpsoni* from Bwayise, Uganda seemed to be inhibited by the enclosed chamber of an olfactometer and that the mosquitoes could not fly inside a Y-tube. Snow (1987) demonstrated that different wall heights could influence the species of mosquito caught indoors; endophilic species such as *An. gambiae s.s.* and *Mansonia* spp. were relatively unaffected by wall height whereas exophilic species such as *Aedes* spp. and *An. pharoensis* showed a marked progressive exclusion with increasing wall height. In the present study, the ports in the olfactometer were fairly narrow (5 cm in diameter) and it is possible that they were more difficult for *An. quadriannulatus* to negotiate than for *An. gambiae s.s.* (see chapter 6 and chapter 8 for further discussion). However, the higher response of *An. gambiae s.s.* in the olfactometer may also be because the SUA colony had been in an artificial environment and experienced more population bottlenecks than the *An. quadriannulatus* colony. The reduced overall response observed with *An. quadriannulatus* was also reflected in the proportion of mosquitoes that left the release cage (85% vs. 99% of *An. gambiae s.s.*).

The response of *An. quadriannulatus* to carbon dioxide was consistent in that there was no preference for the carbon dioxide port or the no odour port, regardless of the concentration or release volume of carbon dioxide (fig.3.2.1). Under similar conditions significantly more *An. gambiae s.s.* mosquitoes entered the control port when carbon dioxide (at either human or cow equivalents) was tested. Carbon dioxide released from

traps in the field very often increases the catch; this may well be because of the plume structure that is encountered in discrete 'packets' (because of natural obstructions such as bushes, trees etc.) rather than a continuous stream (as in the olfactometer). A field study in South Africa found that significantly more *An. quadriannulatus* were collected in traps baited with carbon dioxide than with a human host (Dekker & Takken, 1998). Costantini *et al.* (1996) compared dose response to carbon dioxide with a standard human bait catch. The highest dose of carbon dioxide did not attract more *An. gambiae s.l.* than one human bait catch, whereas the three highest doses of carbon dioxide tested caught significantly more *Mansonia uniformis* (a more generalist feeder) than did one human bait. The response of *Aedes aegypti* (another generalist feeder) to carbon dioxide has been tested many times and generally shows no effect of this gas when tested alone, but a synergistic effect when tested with skin emanations (Gillies, 1980).

In this study, the addition of octenol to carbon dioxide resulted in significantly more *An. quadriannulatus* choosing the no odour port than the carbon dioxide port. This was surprising since octenol has been identified in cow breath and has been effective in trapping a fairly wide range of species of mosquito when combined with carbon dioxide (Takken & Kline, 1989; Kline, 1994; Becker *et al.*, 1995; Van den Hurk *et al.*, 1997). Kline *et al.* (1991) demonstrated an additive effect of carbon dioxide and octenol for *Culex* species and one tabanid (*Diachlorus ferrugatus*) and a synergistic effect with *Aedes taeniorhynchus*. Octenol is present in leguminous plants and is probably released during the process of rumination (Hall *et al.*, 1984) and has also been found in human sweat (Cork & Park, 1996). It is possible that the response of *An. quadriannulatus* to octenol was a result of using an inappropriate concentration of octenol and further studies testing a range of octenol concentrations, in combination with carbon dioxide, are needed to investigate this.

Anopheles quadriannulatus was only attracted to cow odour when this was presented in combination with carbon dioxide. Contrasting results were observed with *An. gambiae s.s.* where carbon dioxide did not increase the number of mosquitoes caught with human odour, but results in fewer mosquitoes caught with cow odour. These results provide further support to the hypothesis that carbon dioxide is a more important cue for zoophilic species when it is present in combination with other odours, such as skin emanations. There was no significant difference between the number of mosquitoes choosing the cow odour port when human odour or no odour were the alternative choices. This appears anomalous for a zoophilic species, because one would have expected significantly fewer mosquitoes to enter either the no odour port or the human odour port

in these circumstances. Furthermore, when human odour was tested alone or against cow odour + carbon dioxide (fig. 3.2.2, test III & V), significantly more mosquitoes entered the human odour port. These results were unexpected; *An. gambiae s.s.* showed similar behaviour under similar conditions (section 3.1.3.1).

It is clear from these results that the behaviour of *An. gambiae s.s.* and *An. quadriannulatus* under the experimental conditions used is very different (see figure 3.2.3), yet these differences are not as stark as was previously thought. Moreover, cross-mating studies and backcrossing schemes attempting to select genes involved in zoophily are unlikely to be successful unless a completely zoophilic mosquito is used to produce the initial F₁ hybrid generation (see Chapter 5).

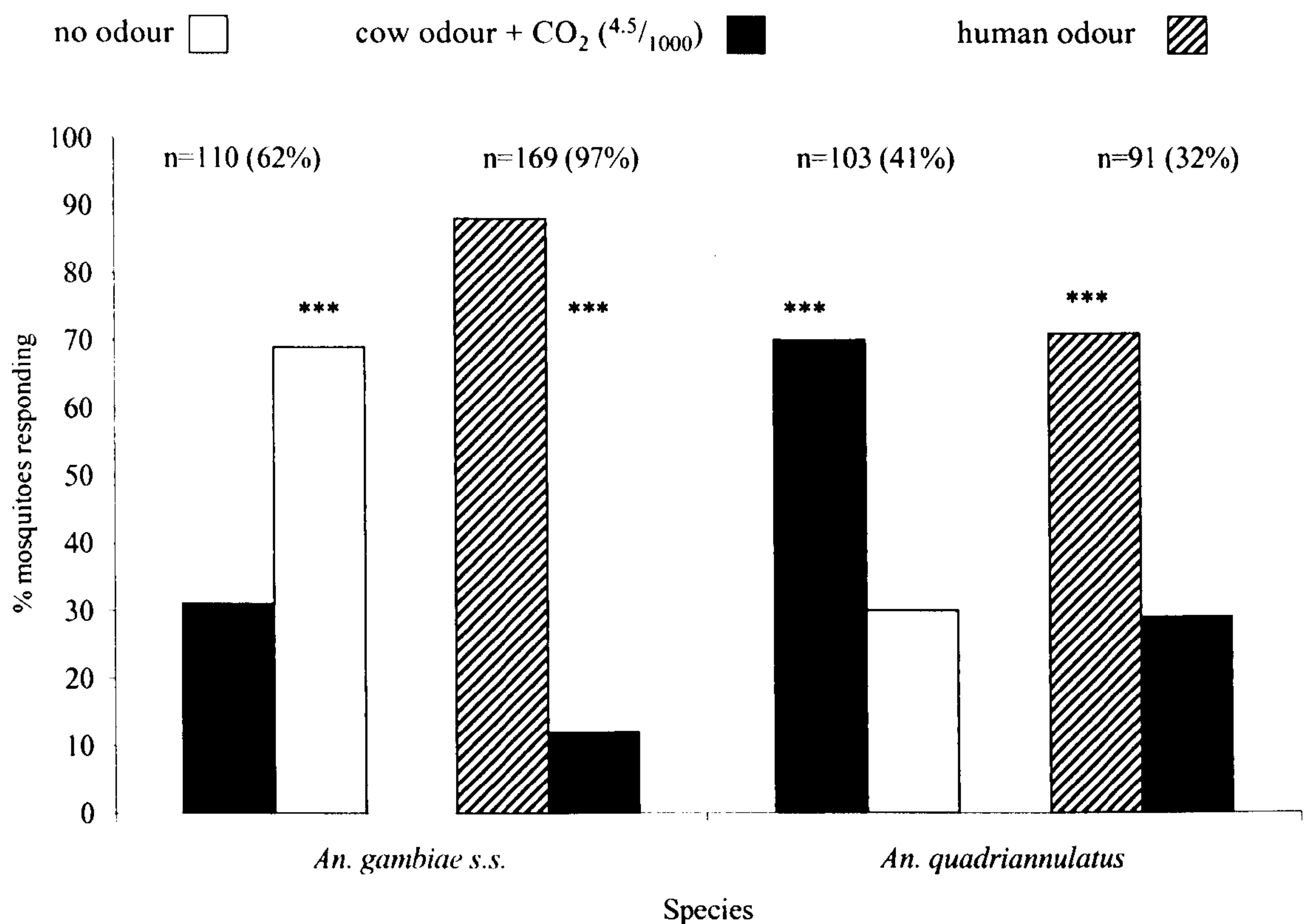

Figure 3.2.3. A comparison of the behaviour of *Anopheles gambiae s.s.* and *An. quadriannulatus* in the olfactometer. Asterisks mark significant differences between the total number trapped in each port (χ^2 test: *** $P < 0.001$). n= total number of mosquitoes entering both traps (also expressed in parentheses as the percentage mosquitoes of the total number of mosquitoes released). CO₂ (4.5/1000)= 4.5% carbon dioxide delivered at 1000 ml min⁻¹.

The human odour stimulus used in these experiments was obtained from a nylon stocking worn by the same person for 24 hours before the experiments took place. The phenomenon of variation in the individual attractiveness of humans has been well documented (Curtis *et al.*, 1987; Knols *et al.*, 1995a & b, Brady *et al.*, 1997) and it is possible that this and previous experiments have produced biased results due to the use of human odour from only one individual. This highlights the importance of using more than one person's odour in olfactometer experiments and may explain why this behaviour in *An. quadriannulatus* has not been recorded before. However, there may have been selection within the colony for a preference for human odour due to feeding females on a human arm. This phenomenon was observed by Laarman (1958) who fed *An. atroparvus* on rabbits in the laboratory (this mosquito feeds on pigs in nature). When laboratory reared and wild *An. atroparvus* were tested in an olfactometer, it was found that odour from a rabbit was significantly less attractive to the wild mosquitoes than to the laboratory reared specimens. It was concluded that the laboratory strain that had been fed on rabbits for at least 20 generations had developed an adaptation to that host.

An alternative explanation for the anthropophilic tendencies observed in the *An. quadriannulatus* mosquitoes tested could have been contamination by the *An. gambiae s.s.* colony. Microsatellite analysis by Dr. S Sinkins (University of Notre Dame, USA) revealed the presence of SUA-sized alleles in the colony, but not in colonies kept in South Africa or Notre Dame, USA (see Appendix I for a brief explanation of the microsatellite analysis and chapter 7 & 8 for further discussion). However, it is possible that both the South African and Notre Dame colonies experienced extensive bottlenecks and consequently lost these rare SUA-sized alleles, whereas the Wageningen colony did not go through such a bottleneck and therefore kept these rarer alleles. Unfortunately, due to a lack of stored material, this hypothesis cannot be verified. It is considered that the most reasonable interpretation of the results is that *An. quadriannulatus* SKUQUA strain is not exclusively zoophilic, but is actually an opportunistic strain although such opportunistic behaviour has not yet been observed in the field (see Dekker & Takken, 1998).

In the light of these results, further work regarding the host-seeking behaviour of *An. quadriannulatus* was required before cross-mating experiments could proceed. In addition, a new colony was started by collecting wild bloodfed female *An. quadriannulatus* specimens from Zimbabwe (Dr. R. Hunt, South African Institute of Medical Research, South Africa) and feeding F₁ females and resulting generations on cow blood via a membrane feeding system (see section 2.1.3).

3.3 Further investigation of attraction of *Anopheles quadriannulatus* to human odour

3.3.1 Introduction

Experiments performed in the olfactometer with *Anopheles quadriannulatus* (SKUQUA strain) showed evidence of partial anthropophily (section 3.2). Mosquitoes were responding to cow skin emanations but, if a choice between human odour or cattle odour + carbon dioxide was given, many of the mosquitoes preferred human odour. The olfactometer has previously only been used to demonstrate positive or negative anemotaxis to certain odour stimuli. It has not been used to distinguish between the two extremes of behaviour seen in the field in *An. gambiae s.s.* and *An. quadriannulatus*. Therefore in order to check on these olfactometer observations, a choice experiment on host preference with a human and a calf as baits was performed under semi-field conditions to investigate the host preferences of these two species.

3.3.2 Materials & Methods

3.3.2.1 Mosquitoes

Three mosquito strains were used; *Anopheles gambiae s.s.* SUA strain (section 2.1.1), (coloured with yellow fluorescent dust (see section 2.1.4)), *An. quadriannulatus* SKUQUA strain (section 2.1.2), (coloured red) and *An. quadriannulatus* SANGQUA strain (section 2.1.3) (coloured blue). Approximately 12 hours before each experiment, 100 unfed females of each strain were removed from their cage at random and starved of sugar solution.

3.3.2.2 Study site and season

A shelter (metal frame with a cotton sheeting roof, 2m x 3m) supporting netting walls 3m high was set up in a field at Wageningen, The Netherlands. No cows or other large animals were present in the field throughout the study. The study was conducted during warm weather in July 1999. A meteorological station (Wageningen University, The Netherlands) next to the field monitored weather conditions throughout the study period (see table 3.3.1).

3.3.2.3 Procedure

Each of 6 replicates of the experiment started at sunset (approximately 21:30 hrs) and finished at sunrise (approximately 05:00 hrs). The experimental set-up is shown in

figure 3.3.1. A calf and a human volunteer were stationed inside the net; a mattress was provided for the human and a straw lined box was provided for the calf. Mosquitoes were released inside the net just before sunset, after which they had free access to feed on either host. At the end of the experiment, mosquitoes were recaptured with an aspirator: searching lasted for 2 hours. Mosquitoes were then separated by species (identified by the coloured powder, viewed by UV light) and squashed onto filter paper. Bloodmeal analysis of each sample was done using the precipitin ring technique (Boreham & Gill, 1973, section 2.7) at the London School of Hygiene & Tropical Medicine by O. Akinpelu and G.S. Gill.

3.3.2.4 Data analysis

As only 1% of the total fed mosquitoes (seen to contain blood) were found to have taken mixed bloodmeals and 8% of the total fed mosquitoes resulted in negative precipitin test readings, these categories were excluded from the analysis. The numbers fed on human or bovine were then treated as binomial data and analysed by logistic regression using SAS software. The average wind speed, relative humidity and temperature for each night was calculated and included in the model to investigate the effect of weather on the biting behaviour of each mosquito strain. Very little rain fell throughout the study period (rainfall on day 2 and day 6 was recorded either before or after the experiment had started) and therefore rainfall was also excluded from the analysis.

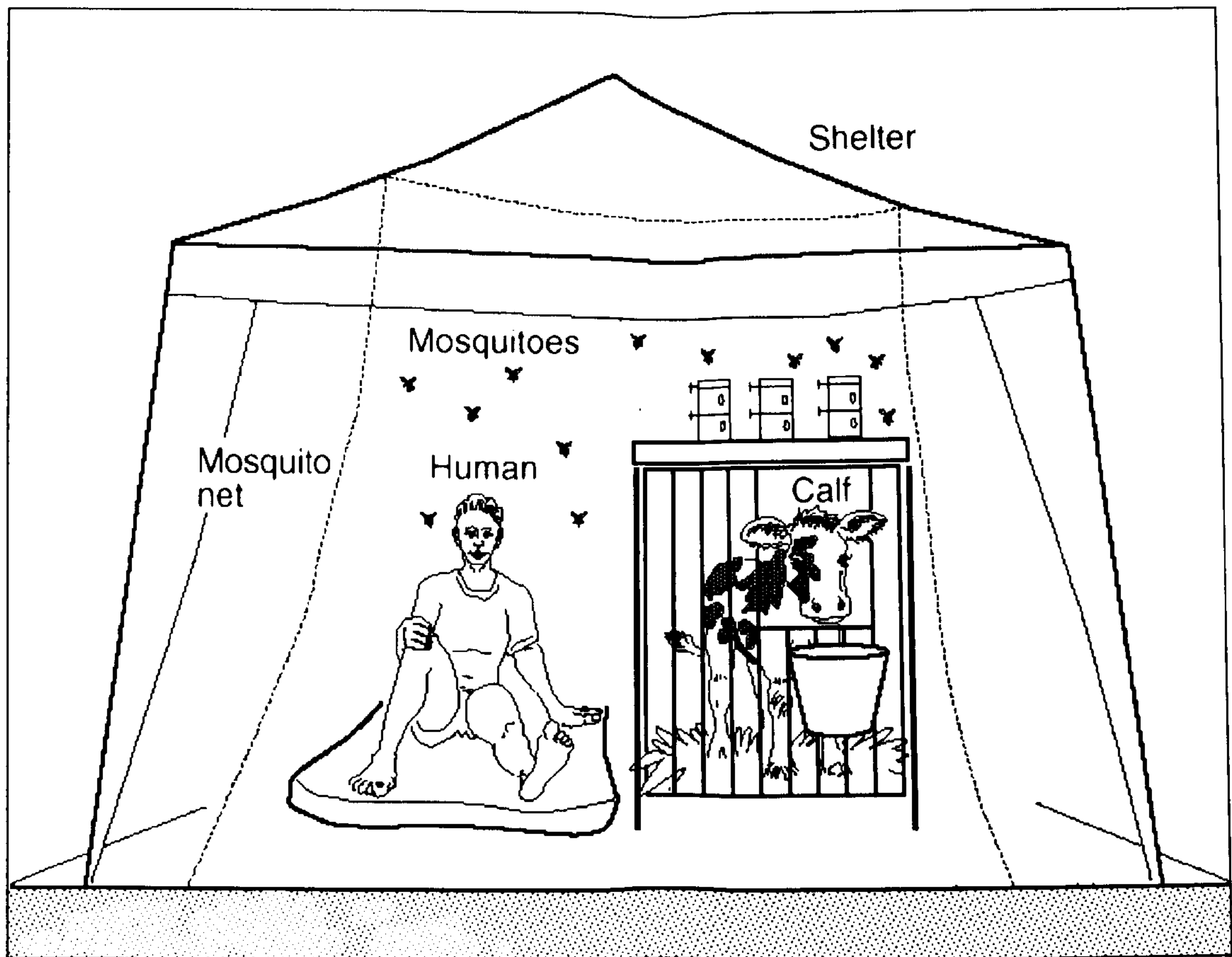

Figure 3.3.1: Choice experimental set-up: mosquitoes were released inside the net from a small cylindrical cage (on top of calf box in diagram). Drawn by Piet Kostense, Wageningen University, The Netherlands.

3.3.3 Results

A summary of the total number of mosquitoes released, recaptured and fed after six experimental nights is given in table 3.3.2. Survival rates were similar for each species/ strain tested.

Table 3.3.1: Meteorological data recorded during the experimental nights. Data were recorded every hour; only the average, minimum and maximum temperature, relative humidity and wind speed are shown.

Weather Conditions		Experiment					
		1	2	3	4	5	6
Temperature (°C)	Ave	17.8	18.1	14.6	20.9	17.1	19.5
	Min	13.5	15.2	13.0	16.6	15.2	17.4
	Max	22.8	22.2	15.7	25.5	22.2	22.7
Relative Humidity (%)	Ave	66.2	86.5	79.2	46.6	90.2	69.2
	Min	56	82	70	31	63	50
	Max	75	91	85	69	100	85
Wind Speed (m/s)	Ave	2.7	2.4	1.49	3.3	0.6	3.1
	Min	1.3	1.5	0.4	1.4	0	2
	Max	3.8	4.1	2.2	4.9	1	3.9
Total Rain (mm)		0	7.9	0	0	0	0.4

Table 3.3.2: Total number of mosquitoes released, recaptured and fed throughout the 6-night study period (neg.= negative response to precipitin test for bovine and human blood).

Mosquito species, strain & origin	Total released	Total recaptured	Unfed	Bloodmeals			
				human	cow	mixed	neg.
<i>An. gambiae s.s.</i> , SUA, Liberia	518	248	66	151	18	2	5
<i>An. quadriannulatus</i> , SKUQUA, South Africa	539	357	88	115	77	5	16
<i>An. quadriannulatus</i> , SANGQUA, Zimbabwe	408	255	69	83	87	0	14

3.3.3.1 Effect of weather on biting behaviour

The logistic regression showed a significant effect of weather (data taken from table 3.3.1) on the proportion of mosquitoes biting the human. However, this effect differed depending on the order that the variables (average temperature, wind speed and relative humidity) were entered into the model. Because the weather variables were nested within “day” (i.e. weather conditions differed each day), the effect of day on the proportion of mosquitoes biting the human was also tested. There was a significant day effect ($P<0.01$) but in all models examined, the effect of mosquito strain was overwhelmingly larger and more significant ($P<0.0001$) than either weather or day effects (see table 3.3.3).

Table 3.3.3: Logistic regression statistics for type 1 analysis; testing the effect of day and mosquito type on the proportion human bloodmeals analysed. d.f.= degrees of freedom.

Source	Deviance	d.f.	Chi Square	P-value
Intercept	92.8533	0	.	.
Day	77.8049	5	15.0484	0.0102
Mosquito	3.9675	2	73.8373	0.0001

3.3.3.2 Bloodmeal analysis

The proportion of the total bloodmeals taken on both hosts by each mosquito strain over the study period are shown in fig. 3.3.2.

A similar number of bloodmeals were analysed for each mosquito strain. There was a significant difference between the feeding behaviour of *An. gambiae s.s.* and both strains of *An. quadriannulatus* ($P<0.0001$). However, there was no significant difference between the feeding behaviour of the two strains of *An. quadriannulatus* ($P=0.1109$). In total, *An. gambiae s.s.* took 88% of its bloodmeals from the human host, whereas the *An. quadriannulatus* strains took 49-58% of their bloodmeals from the human host.

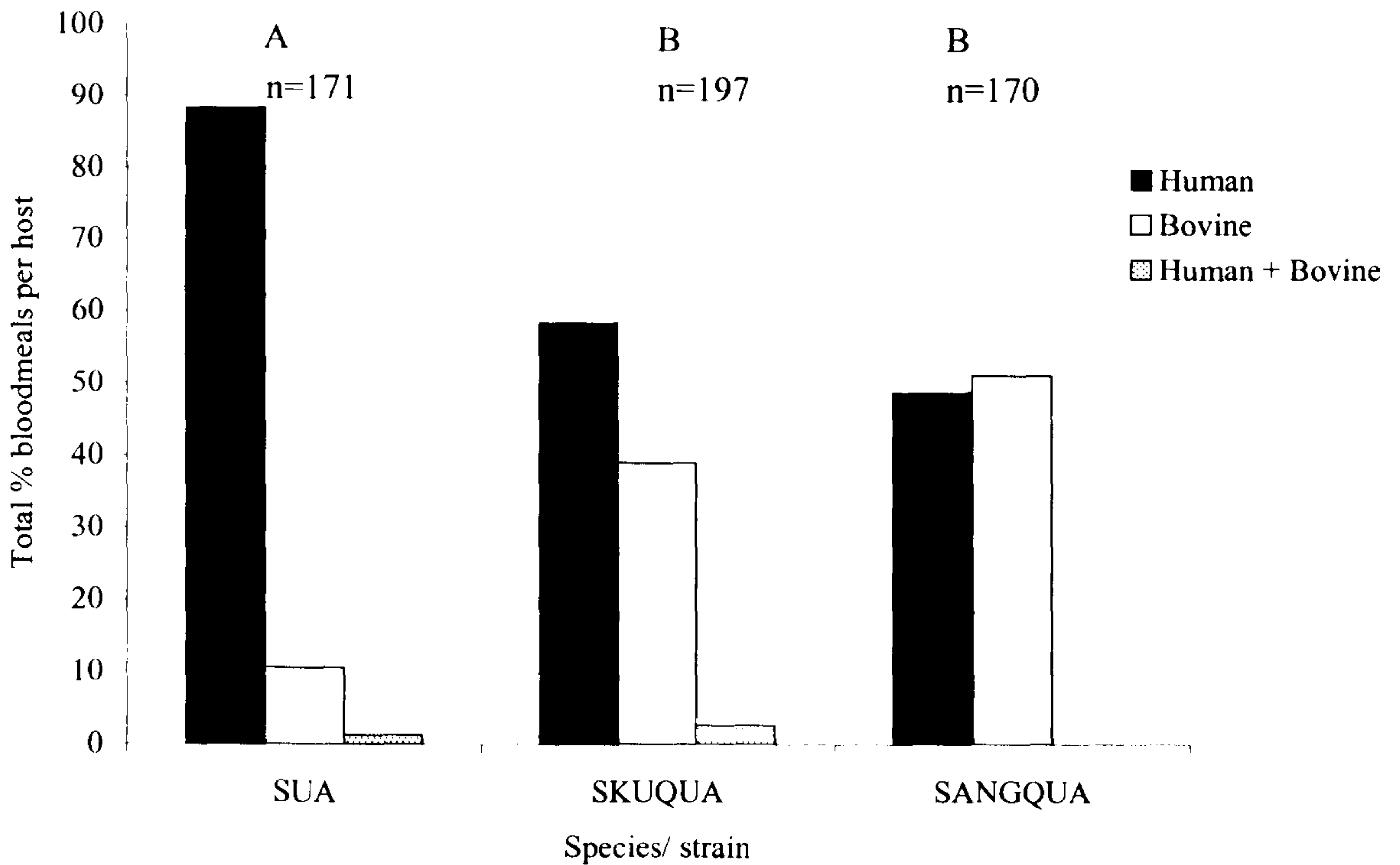

Figure 3.3.2: Feeding preference of *Anopheles gambiae s.s.* (SUA strain) and *An. quadriannulatus* (SKUQUA and SANGQUA strain). The feeding behaviour of each mosquito strain tested is represented by the overall percentage of bloodmeals taken from each host after 6 nights (calculated by: (total human (or cow or mixed) bloodmeals/ total bloodmeals) x 100). Different letters indicate that results for species/ strains are significantly different from one another. n= total number of bloodmeals analysed.

3.3.4 Discussion

The effect of the weather on this small data set on the feeding behaviour of *An. gambiae s.s.* and *An. quadriannulatus* in this study was inconclusive. However, these experiments were conducted in the Netherlands where the outdoor evening weather conditions (even in summer) are considerably different to those either in the insectary or in the natural African habitat of these *Anopheles* mosquitoes. It was therefore considered important to include these variables in the analysis in order to check that these environmental conditions were not the main cause of differences in feeding behaviour among the mosquito strains tested. The effect of mosquito strain on feeding behaviour was far more important than either day effects or weather effects and therefore no further analysis regarding the weather effects was performed.

The results show that the majority of bloodmeals taken by *An. gambiae s.s.* were from the human host, which would be expected for such an anthropophilic mosquito. A similar degree of attraction to human odour and aversion to cow odour was observed in the dual port olfactometer where 88% of *An. gambiae s.s.* tested entered the port containing human odour and 12% entered the port containing a combination of cow odour and carbon dioxide (section 3.1).

Both strains of *An. quadriannulatus* showed significantly different behaviour from *An. gambiae s.s.*. However, an unexpectedly high proportion of *An. quadriannulatus* fed on the human host. Populations of *An. quadriannulatus* are widespread in southern Africa and mainly found in association with cattle (White, 1974a). Sharp *et al.* (1984) used a man-baited and goat-baited net trap to sample the anopheline population in the malaria endemic area of KwaZulu-Natal. Only two *An. quadriannulatus* individuals were caught in a man-baited net trap compared to 35 in a goat-baited net trap. Blood meal tests performed on *An. gambiae s.l.*, collected from a man-baited trap, revealed that 85% of the specimens fed on man. However, as pointed out by Coetzee & Hunt (1985), these blood meals were from unidentified *An. gambiae s.l.*. Therefore it was not possible to conclude that *An. quadriannulatus* was caught biting man in man-baited net traps. Dekker & Takken (1998), collecting mosquitoes in human and calf-baited net traps in South Africa, found that *An. quadriannulatus* only entered the calf-baited trap, confirming the high degree of zoophily previously recorded for this species.

Although house resting adult populations of *An. quadriannulatus* have been observed in South Africa and Zimbabwe (Hunt & Mahon, 1986), they are found more frequently in buildings with cattle only or with humans and cattle together (White, 1974a). Malaria sporozoites have so far not been found in wild *An. quadriannulatus*,

although recent laboratory experiments have shown that *An. quadriannulatus* is susceptible to *Plasmodium falciparum* (Takken *et al.*, 1999). *Anopheles quadriannulatus* is also susceptible to the human filarial worm *Wuchereria bancrofti* (Hunt & Gunders, 1990). If *An. quadriannulatus* populations are not as strictly zoophilic as has been generally believed this could have implications for vector borne disease control.

When members of the SKUQUA strain were found to be attracted in the olfactometer to human odour it was first thought that the laboratory maintenance of SKUQUA had selected for attraction to human odour. However, in the light of the results discussed in this section this seems unlikely because there was no significant difference between the proportion feeding on the human of this strain and the SANGQUA strain, which had only been in the laboratory for four months and was fed on cattle blood through a membrane. Polytene chromosome sequence analysis by Dr. A. Della Torre (Coluzzi *et al.*, 1979) confirmed that both strains were cytotaxonomically typical of *An. quadriannulatus* (see also the results from the microsatellite analysis of mosquitoes from both *An. quadriannulatus* colonies described in chapter 7). This study suggests that further work on the presumed zoophilic nature of *An. quadriannulatus* in its natural habitat is necessary.

3.4 Differential responses of *Anopheles gambiae s.s.* and *An. quadriannulatus* to two individuals

3.4.1 Introduction

It is well known that humans differ in their level of attractiveness to mosquitoes (for example Haddow, 1942; Muirhead-Thomson, 1951; Curtis *et al.*, 1987; Lindsay *et al.*, 1993). Anthropophilic tendencies have been observed in olfactometer experiments performed with *An. quadriannulatus* (section 3.2) that had not been recorded previously (Dekker *et al.*, 2001a). The human odour used in these studies had been collected from one person only, using a nylon stocking. To investigate the nature of the differences between the two studies, a further study was undertaken to compare the response to skin emanations from two humans, collected on nylon stockings that were worn for 24 hours, placed in a small glass vial and then frozen (stockings were frozen because one of the human test subjects was not available throughout the study). Four different odour combinations were tested on the same day and *An. gambiae s.s.* and *An. quadriannulatus* (SANGQUA) were released simultaneously into the olfactometer. *Anopheles gambiae s.s.* was marked with a yellow fluorescent dust for easy identification. The aim of these experiments was to investigate differences in the level of attraction of the two humans to *An. gambiae s.s.* and *An. quadriannulatus*. The subject HP (female) was the human subject used in the work described in sections 3.2 & 3.3 and TD (male) was the human subject used in the study reported by Dekker *et al.* (2001a) and Dekker & Takken (1998).

3.4.2 Materials & methods

Mosquitoes from the SUA colony (section 2.1.1) were colour marked (section 2.1.4) and released simultaneously into the olfactometer (sections 2.2- 2.5) with unmarked mosquitoes from the SANGQUA colony (section 2.1.3). This dust has been shown to have no effect on mosquito behaviour in the olfactometer (Dekker *et al.*, 2001a). Seven replicate experiments were performed.

3.4.3 Results

The proportion of *An. gambiae s.s.* and *An. quadriannulatus* leaving the release cage and flying upwind towards the ports was similar (96.7% and 86.7% respectively of 840 mosquitoes tested) to that observed in previous studies (sections 3.1 & 3.2). The mean percentage of mosquitoes responding to odour stimuli was significantly different between *An. gambiae s.s.* and *An. quadriannulatus* (63.5% vs. 8%). Because of the small

number of *An. quadriannulatus* responding, the response of *An. quadriannulatus* cannot be as accurately interpreted as the response of *An. gambiae s.s.*. There was no significant effect of day on the total catch size of either mosquito species, obtained with each experiment (ANOVA, $P>0.05$) and no significant difference in the total number of mosquitoes of each species responding in each experiment. The results are shown in figure 3.4.

The olfactometer was symmetrical and there was no significant difference between the number of mosquitoes responding to either clean stocking tested (fig. 3.4, test I). When individual TD was tested against the control, significantly more *An. gambiae s.s.* ($P<0.001$) entered the port containing the human odour, whereas there was no significant difference between the number of *An. quadriannulatus* entering the human odour port or the control port. However, when individual HP was tested against the control, significantly more *An. gambiae s.s.* ($P<0.001$) and *An. quadriannulatus* ($P<0.05$) entered the human odour port. There was no significant difference between the number of *An. gambiae s.s.* entering either port when odour from TD was tested against odour from HP, whereas odour from HP was significantly more attractive ($P<0.05$) to *An. quadriannulatus* than odour from TD.

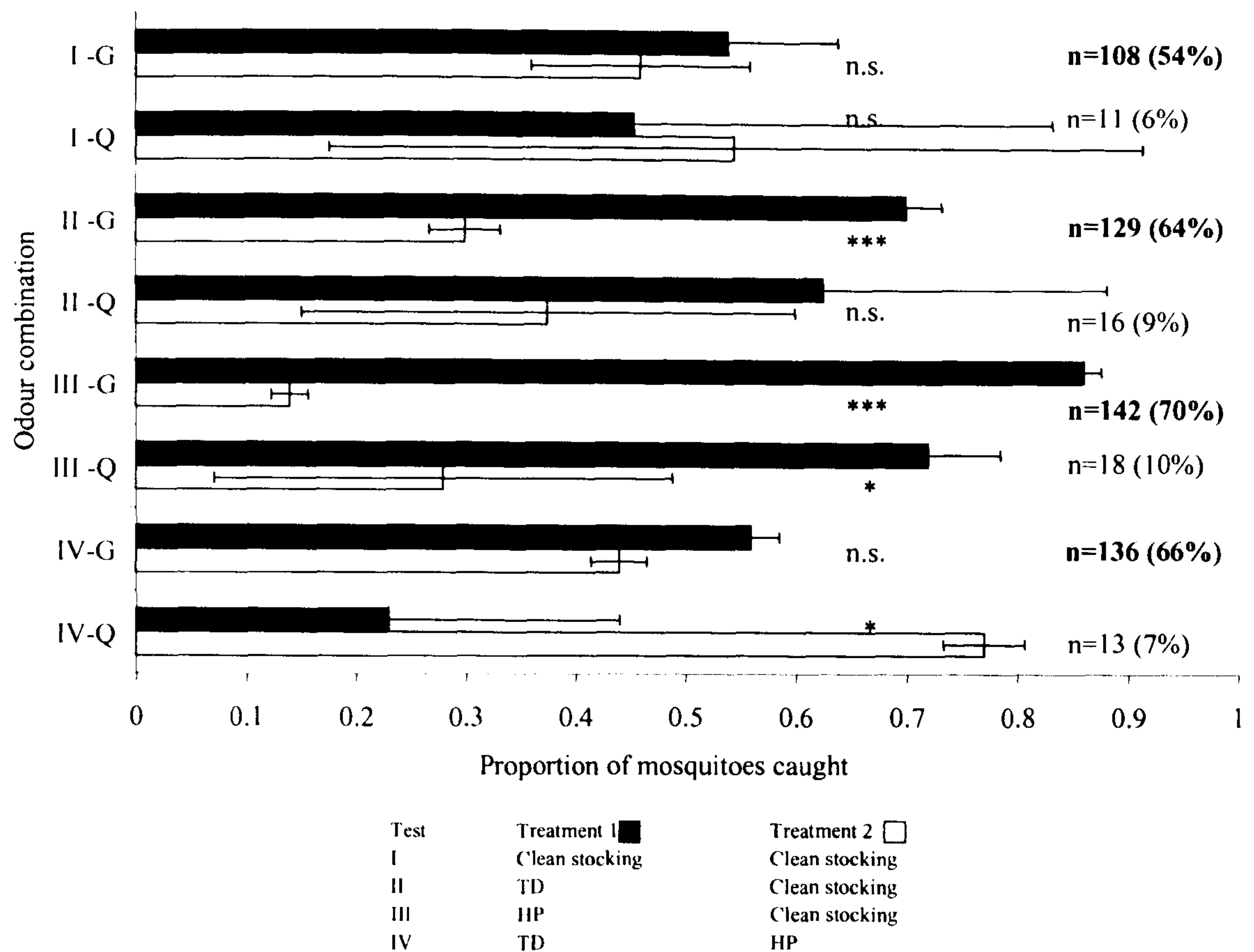

Figure 3.4. Catches of *An. gambiae s.s.* and *An. quadriannulatus* SANGQUA strain with human odour from two individuals. The total percentage of mosquitoes responding to each odour in seven replicate trials is shown. Asterisks mark significant differences between the total number trapped with each stimulus within an experiment (χ^2 test: n.s.: $P > 0.05$, * $P < 0.05$, *** $P < 0.001$). n= total number of mosquitoes entering both traps (also expressed in parentheses as the percentage mosquitoes responding out of the total number of mosquitoes released in seven replicates). Error bars show 95% confidence limits. The table below the graph indicates the odour combination tested with either *An. gambiae s.s.* (G) or *An. quadriannulatus* (Q). TD = odour from human subject 1, HP = odour from human subject 2.

3.4.4 Discussion

These results show that a similar number of *An. gambiae s.s.* were caught with odour from HP and odour from TD, whereas significantly more *An. quadriannulatus* were caught with the odour from HP than the odour from TD. The response of *An. gambiae s.s.* and *An. quadriannulatus* in the olfactometer was significantly different in that the number of *An. gambiae s.s.* responding was far greater than the number of *An. quadriannulatus* responding. This could be due to several factors including the exophilic behaviour of *An. quadriannulatus*, already mentioned (section 3.2) or the absence of carbon dioxide or other stimuli associated with zoophilic behaviour. The response of *An. gambiae s.s.* to the odour of both individuals tested was consistent with previous experiments (see section 3.1. and Dekker *et al.*, 2001a). Significantly more mosquitoes entered the human odour ports than the control ports and there was no difference between the attractiveness of either human tested. However, the response of *An. quadriannulatus* to each individual was different; individual HP was more attractive than individual TD. Furthermore, significantly more *An. quadriannulatus* entered the port containing odour from HP ($P < 0.05$) than the control port, whereas there was no significant difference in the number of mosquitoes entering the port containing odour from TD or the control port. Dekker *et al.* (2001a) found that significantly more ($P < 0.05$) *An. quadriannulatus* entered the no odour port when the odour from subject TD was tested. However, these results are consistent with previous findings and may explain why the apparent anthropophilic behaviour observed in section 3.2 had not been recorded previously. The outdoor baited traps used in South Africa by Dekker and Takken (1998) to trap wild *An. quadriannulatus* also used subject TD, which may explain why so few *An. quadriannulatus* mosquitoes were caught in the human baited trap. This will be discussed in chapter 8.

These experiments demonstrate the importance of using more than one human test subject when testing the response of mosquitoes to human odours. Braks and Takken (1999) found differential responses of *An. gambiae s.s.* to sweat samples from three volunteers and attributed these differences to the presence and growth of skin flora, the pH of the sweat and individual differences in sweat composition. The sweat sample from subject TD (who also took part in the study of Braks & Takken, 1999) was found to be more alkaline than the other subjects tested, and the pH of TD's sweat did not change after incubation at 37°C, as did the other samples.

Pregnant women are more attractive to *An. gambiae s.l.* than non-pregnant women (Lindsay *et al.*, 2000) and adults have been shown to be more attractive to *An. gambiae*

s.l. than children (Thomas, 1951; Carnevale *et al.*, 1978; Port *et al.*, 1980). Knols *et al.* (1995a) used human-baited tent traps in north-east Tanzania to assess the attractiveness of three humans and found significant differences caused by inter-person variation for *An. gambiae s.l.*, *An. funestus* and *Culex quinquefasciatus*, but not for *Mansonia* species. In Burkina Faso, Brady *et al.* (1997) used human bait catches to rank catchers from 'most attractive' to 'least attractive' and found that the same ranking was observed when the catchers' odours were tested in an odour baited entry trap. However, this ranking was lost when the carbon dioxide output for each individual was standardised.

Differences in the attractiveness of individual cows to mosquitoes and other biting flies have also been observed. A natural repellent, 6-methyl-5-hepten-2-one, has been identified from a cow that was consistently observed surrounded by few flies (Agelopoulos *et al.*, 1998; Birkett *et al.*, 1998) and it is possible that certain species or individuals may possess more of this repellent chemical than others. Microsatellite markers have been used to identify individual members in a herd of 29 cattle in Zimbabwe (A. Prior & S. Torr, personal communication). It was found that tsetse flies only fed on adult cows, stable flies took approximately a quarter of their meals from calves and took no mixed meals and mosquitoes took meals on calves and adult cows and took mixed meals. Furthermore, *An. arabiensis* was more likely to take mixed meals or meals from hosts outside the herd (because of more frequent feeding or more interrupted feeds) than *An. quadriannulatus*. These observations may be due to differences in individual odour, differences in irritability or a combination of these factors. A baited pit trap and target were used to measure the attractiveness of cattle to tsetse flies in Zimbabwe (Torr *et al.*, 2001). In general, it was found that the size of the catch increased as the weight of the animal increased (see also Vale, 1993), a bull caught more flies than a lactating cow and synthetic cow odour was never as good as a live bull. Increasing the amount of carbon dioxide from traps baited with a calf increased the catch but the size of the catch was never as large as that obtained with an adult ox. It was concluded that the differences observed between animals were not entirely due to carbon dioxide, but to another (as yet) unidentified odour.

In conclusion, *An. gambiae s.s.* showed no significant preference for either human tested but *An. quadriannulatus* showed indications of being preferentially attracted to one of the humans tested. Standard odour baits, both anthropophilic and zoophilic in nature, consisting of the odour from more than one human and more than one cow, respectively will be necessary for a comprehensive study of the host-seeking behaviour of these sibling species.

Chapter 4

STANDARDISATION OF THE OLFACTOMETER BIOASSAY

4.1 Evaluation of the effectiveness of skin washings in the olfactometer

4.1.1 Introduction

Previous odours used in the olfactometer bioassay included nylon stockings containing skin residues (from a human or cow) and carbon dioxide (sections 3.1, 3.2 & 3.4). However, variation between experiments and experimental days may be high due to the physical activity of the human or cow, which may result in different combinations of attractive or repulsive components in the stocking. There may also be considerable variation between individuals and the attractiveness of various mosquito species to those individuals (section 3.4). Therefore, the olfactometer bioassay was standardised by preparing 'standard' odour baits using skin washings from humans and cows. The skin washings were considered to be 'standard' because the same stimulus could be used over a series of experimental days (or weeks or months), which could not be done with the stockings.

The skin washings were tested in the olfactometer in order to investigate the best presentation medium and the attractiveness of *An. gambiae s.s.* to the skin washings. A dose-response series using the human skin washing was also performed to investigate the optimum dose required to obtain a good response from *An. gambiae s.s.*. This series of evaluation experiments were not completed with *An. quadriannulatus* because of colony fragility at the time of the experiments (see later experiments with this species in section 4.2).

4.1.2 Materials & Methods

The following procedure for preparation of the skin washings is based on a protocol developed by Geier *et al.* (1996) and used by Braks (1999).

4.1.2.1 Sample collection

Standard odour stimuli were prepared by soaking cotton wool pads (approximately 7cm²) in 98% ethanol and thoroughly wiping the hands and feet of 50 individuals (31 males and 19 females, aged between 21 and 56 years from the Department of Entomology, Wageningen University, The Netherlands) and the head region, the back and the throat of 34 cattle (32 females and 2 males, from De OsseKampen, Wageningen,

The Netherlands). Ethanol was chosen as a solvent after Geier *et al.* (1996). As many volunteers as possible were used to obtain the human skin washings (i.e. 50 people) and only 34 cows were available at the farm. The pads were wrapped individually in aluminium foil and placed in a labelled plastic bag in a freezer at -80°C . Once all the samples had been collected, cotton pads were removed from the freezer and left to air dry on the laboratory bench for 24 hours (to allow the ethanol to evaporate).

4.1.2.2 Extraction process

The human and cow skin washings were prepared separately to avoid any contamination. The dried cotton pads were packed tightly into a glass tube (2.8 x 150 cm). A solvent pump was set up to pump 98% ethanol into the glass tube at 1.5 ml min^{-1} . This pump was left to run for 6 hours and the extraction was collected in a glass bottle and placed at 4°C until further use. The human skin washing was light yellow in colour whereas the cow skin washing was green-yellow in colour, with a heavier, brownish layer at the bottom. After one day at 4°C , a white substance had formed on the bottom of the bottle.

4.1.2.3 Concentration of the extraction

A Rotavapor RE120 (BÜCHI, Germany) was used to evaporate the ethanol from the skin washing extractions. A continuous vacuum at 500 mbar was set up with cooling water running at approximately 40 litres per hour. The water bath was set at 37°C and a spherical glass flask containing the skin washing extraction was lowered into it, so that approximately $\frac{3}{4}$ of the extract was heated by the water bath. The rotation speed was set at six.

The human skin washing extract was concentrated from 450ml to approximately 75ml in 9 hours. After concentrating, the extract was yellow and slightly opaque. The cow skin washing extract was concentrated from 450ml to approximately 85ml in 9.5 hours, after which the extract was green/ brown in colour and a slimy green ball approximately 1 cm in diameter had formed at the base of the evaporating flask.

4.1.2.4 Removal of excess solvent

The concentrated extract was placed at -20°C for at least 5 hours then removed, divided into 1.5 ml eppendorf tubes and centrifuged for 10 minutes at 10,000rpm. The human skin washing yielded a slightly yellow supernatant and a white pellet after centrifuging. The supernatant was removed, placed in a fresh eppendorf, labelled and

stored at 4°C. The end volume of the extract was 67.5ml (45 x 1.5ml aliquots). The cow skin washing yielded a green/ yellow supernatant and a light green pellet. The supernatant was removed, placed in a fresh eppendorf, labelled and stored at 4°C. The end volume of the extract was 82.5ml (55 x 1.5ml aliquots).

4.1.2.5 Standardisation of extracts

Nylon stockings were weighed before being worn, immediately after being worn (for 24 hours) and after being kept in a sealed glass jar for 24 hours. This was to give an indication of the amount of skin residue present when a worn stocking was used as the odour source. On average, one 'human' stocking contained 0.2925g of skin residue.

The dry weight of the skin washings was determined by completely evaporating 1ml of the extract. A clean eppendorf was weighed, filled with 1ml of extract and re-weighed. Three small holes were pierced in the lid of the eppendorf, which was then placed in a rotating vacuum evaporator (Speed Vac Plus®, SC110A, Savant) for 1.5 hours. The average dry weight of 1ml of the human skin washing was calculated as 0.013g and that of the cow skin washing as 0.007g. Using the dry residue weight as a guide, different volumes of skin washing were tested in the olfactometer to assess the dose-response of *An. gambiae s.s.*.

4.1.2.6 Odour presentation in the olfactometer

Since the skin washings were in liquid form (the remaining alcohol quickly evaporated leaving behind the skin washing), an appropriate method of odour presentation was required. Two methods were tested; a measured amount of skin washing was either pipetted onto a sand blasted glass slide (sand blasted at the Department of Entomology, Wageningen University, The Netherlands) or onto a piece of nylon stocking (approximately 5cm²). Both glass slides and stocking pieces were sterilised by rinsing in alcohol, autoclaving and then air drying at 55°C. The skin washing (100µl) was then pipetted onto the glass slide or stocking piece allowing approximately 5 minutes before the experiment for the excess alcohol to evaporate. Ethanol was used as a control.

4.1.2.7 Olfactometer experiments

Mosquitoes from the *An. gambiae s.s.* SUA colony described in section 2.1.1 were used in the olfactometer experiments (see sections 2.2, 2.4 & 2.5).

4.1.3 Results

In total 1440 *An. gambiae s.s.* SUA mosquitoes were tested, of which 98% left their release cage and entered the flight chamber. There was no effect of day on the total catch size obtained with each experiment (ANOVA, $P > 0.05$) and the olfactometer was symmetrical throughout the experimental period. Results are shown in figure 4.1.1. Significantly more mosquitoes entered the port containing human odour from a worn stocking than the no odour port ($P < 0.001$), as was expected from previous experiments (see figs. 3.1.1 and 3.4). Significantly more mosquitoes entered the port containing human skin washing on a sand blasted slide than the control port or the port containing human skin washing on a nylon-stockings piece ($P < 0.001$) (fig. 4.1.1, test III & V). There was no difference between the total number of mosquitoes responding to odour from a stocking that had been worn by a human (fig. 4.1.1, test II) or the human skin washing on a glass slide (fig. 4.1.1, test III). Mosquitoes showed no preference when human skin washing on a nylon-stockings piece (fig. 4.1.1, test IV) or cow skin washing (on a sand blasted slide) (fig. 4.1.1, test VI) was tested against a control. Significantly more mosquitoes entered the port containing human skin washing (on a slide) when tested against either cow skin washing alone ($P < 0.05$) (fig. 4.1.1, test VII) or cow skin washing with carbon dioxide ($P < 0.001$) (fig. 4.1.1, test VIII).

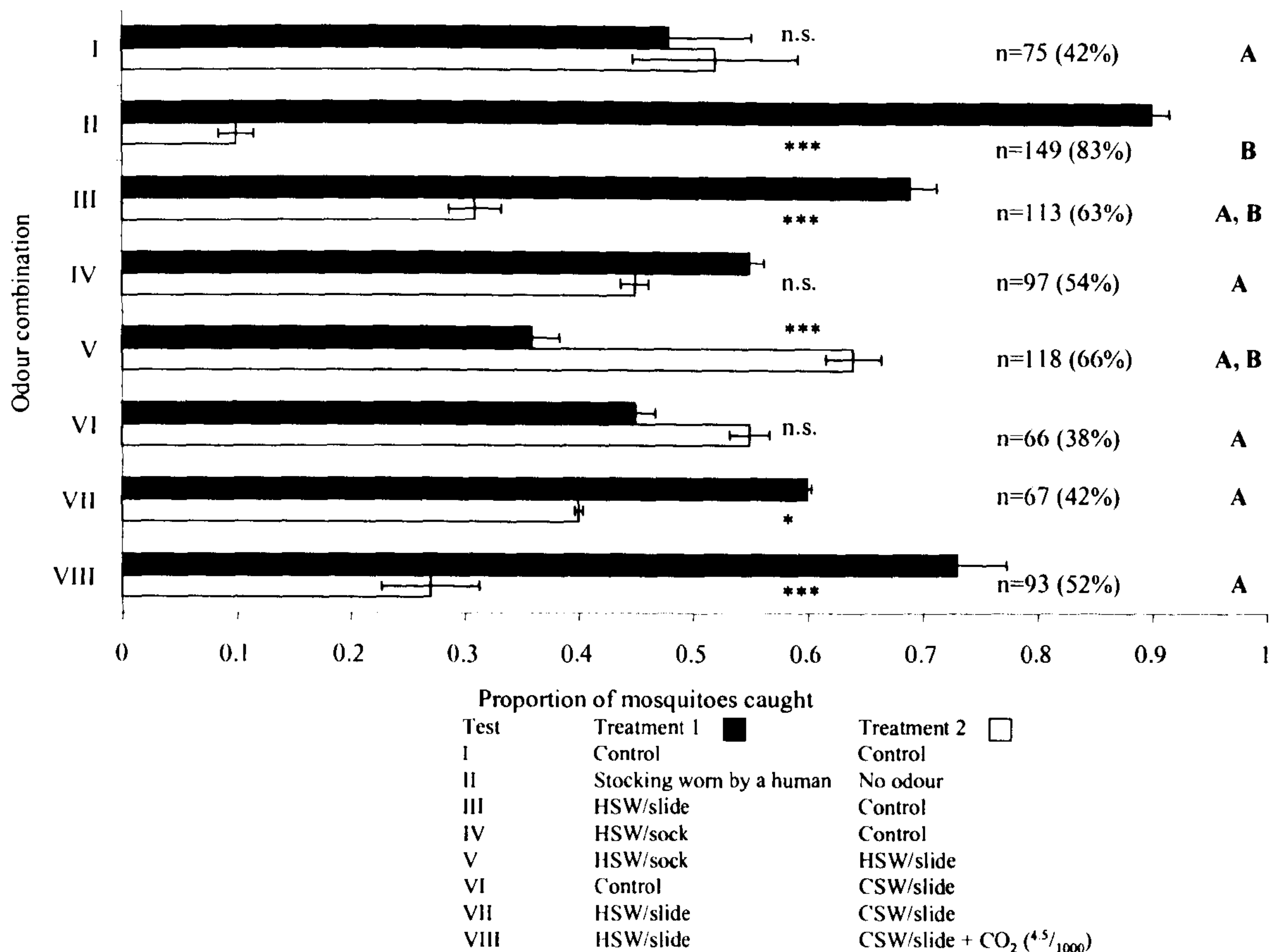

Figure 4.1.1 Evaluation of the catch of *Anopheles gambiae* s.s. with skin washings. The total proportion of mosquitoes flying into either test port in six replicate trials is shown. Asterisks mark significant differences between the total number trapped in port 1 and port 2 (χ^2 test: n.s.: $P > 0.05$, $*P < 0.05$, $***P < 0.001$). n= total number of mosquitoes entering both traps (also expressed in parentheses as the percentage mosquitoes responding out of the total number of mosquitoes released in six replicates). Different letters indicate significant differences in the total number of mosquitoes responding in each experiment. Error bars show 95% confidence limits. The table below the graph indicates the odour combination tested. Control = 100 μ l evaporated ethanol on a sand blasted slide (or stocking piece in experiment IV); HSW/slide = 100 μ l evaporated human skin washing on a sand blasted slide; HSW/sock = 100 μ l evaporated human skin washing on a nylon stocking piece; CSW/slide = 100 μ l evaporated cow skin washing on a sand blasted slide; CSW/slide + CO₂ (4.5/1000) = 100 μ l evaporated cow skin washing on a sand blasted slide + 4.5% carbon dioxide delivered at 1000mlmin⁻¹.

In the dose-response series (table 4.1 & figure 4.1.2), there was no significant difference in the total number of mosquitoes responding to each dose or between experimental days (ANOVA, $P>0.05$). There was also no significant difference between doses (with the exception of 150 μ l human skin washing). Significantly more mosquitoes entered the port containing the human skin washing than the control port ($P<0.001$). However when 150 μ l human skin washing was tested, mosquitoes showed no preference for the skin washing port or the control port.

Table 4.1 Total number of *An. gambiae s.s.* caught in each trap of the olfactometer after 6 experimental days testing the dose-response to human skin washings. No significant differences between the overall response with each dose were observed.

Total number of mosquitoes	Dose of Human Skin Washing applied to glass slide (μ l)				
	100	150	200	250	300
Caught in human skin washing port	66	52	66	74	72
Caught in control port	37	57	33	36	48
Tested	179	176	177	178	180
Overall % response	57.5	61.9	55.9	61.8	66.7

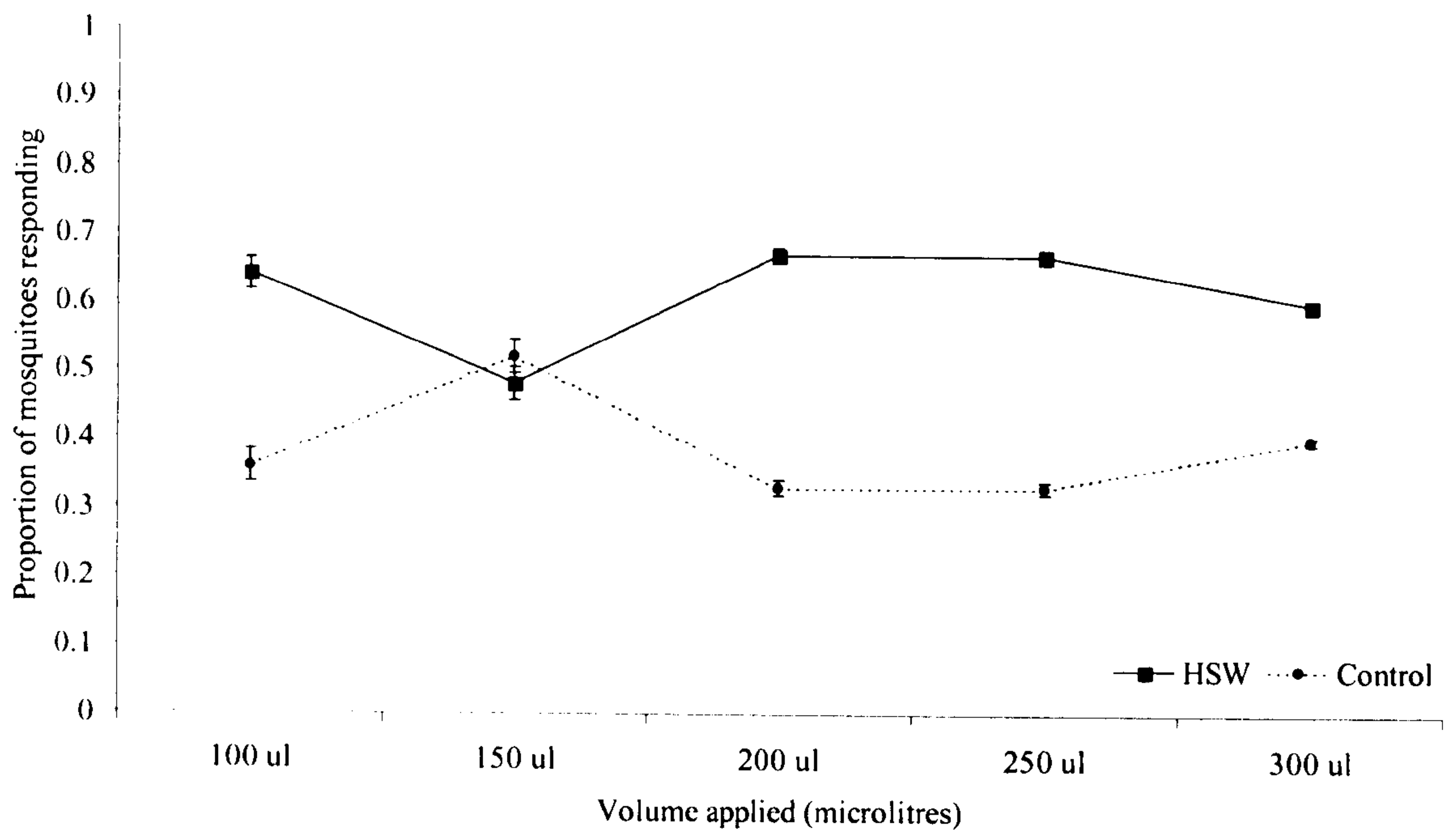

Figure 4.1.2. Dose-response of *An. gambiae s.s.* to human skin washings tested on a glass slide in an olfactometer. Each point represents the mean proportion of mosquitoes responding to the odour stimulus from six replicates. Error bars represent 95% confidence limits. The proportion of mosquitoes entering the control port is included for comparison.

4.1.4 Discussion

The results showed that skin washing on a sand blasted slide was a better presentation medium than the same quantity of skin washing placed on a nylon stocking piece. Furthermore, the response to the human skin washing was as good as (but not better than) a stocking worn by a human. There was no significant difference in the number of mosquitoes entering the control port or the port containing skin washing on a nylon stocking piece. It is possible that essential volatiles were bound to stocking fibres or that the alcohol did not evaporate completely and somehow 'masked' the human odour in the human skin washing. There was no significant difference in the total number of mosquitoes caught with the odour from a stocking that had been worn by a human or odour from human skin washing on a glass slide (83% vs. 63% respectively). Mosquitoes preferred to enter ports containing the human skin washing when it was tested against a control, the cow skin washing or the cow skin washing combined with carbon dioxide.

Similar results were obtained when the same odour combinations were tested using skin emanations from stockings that had been worn by a human (section 3.1). Therefore, the skin washings are a suitable alternative to skin emanations from stockings and can be considered as 'standard' odour stimuli useful for more accurate comparisons between experiments (skin washings contained the odour from 50 individuals whereas when a stocking contained the odour from only one individual).

Results from the dose-response series showed that there was no difference in the response of *An. gambiae s.s.* to 100, 200, 250 or 300 μ l human skin washing. Therefore the most economic (and equally effective) dose of 100 μ l skin washing was chosen as the standard dose for use in future bioassays. Mosquitoes showed a marked reluctance to enter ports containing cow skin washing (also at a dose of 100 μ l) therefore the same dose was also used for future experiments with the cow skin washing. It is not clear why there was no significant difference between the response of mosquitoes to 150 μ l of human skin washing and the control. Techniques such as electroantennogram gas-linked chromatography (EAG-GC) and mass-spectrometry could reveal the presence of certain crucial components that may perhaps reduce the attractiveness of the human skin washing at this dose and would certainly aid in the search for the specific compounds present in human odour that are attractive to mosquitoes. This was not done with these skin washings.

These skin washings provoked the same behavioural response that was observed with skin emanations from nylon stockings, which was a very important advance for the behavioural studies discussed in chapter 5. Considerable bias can be introduced into an olfactometer experiment by using only one host, as discussed in section 3.4; the human skin washing represented the combined odour of 50 people, including men and women from a wide age range and the cow skin washing represented the combined odour of 35 cattle. Whilst the response of mosquitoes to these skin washings may be slightly lower than that observed with nylon stockings, it is considered that the results observed with the skin washings provide a fairer representation of host-preference since these experiments included the odour from more than one host. Furthermore, the use of skin washings prevented the need to depend on live hosts, which can be both intrusive and inconvenient for the host involved. The skin washings provided a constant odour blend that could be used in olfactometer experiments over a period of one year (see section 4.2), allowing comparisons between different experimental days (and weeks) to be made more accurately.

4.2 A comparison of the response of *Anopheles gambiae* s.s. and *Anopheles quadriannulatus* to skin washings in the olfactometer

4.2.1 Introduction

The *An. quadriannulatus* SANGQUA colony (see section 2.1.3) was too fragile to remove large numbers of mosquitoes and undertake a large series of experiments at the time the evaluation of the effectiveness of skin washings took place (section 4.1). However, experiments comparing the response of *An. gambiae* s.s. and *An. quadriannulatus* to skin washings were completed eighteen months later. The aim of these experiments were two-fold:

- i) To evaluate the response of *An. quadriannulatus* (SANGQUA) to skin washings.
- ii) To re-assess the response of *An. gambiae* s.s. to skin washings after eighteen months in storage at 4°C.

4.2.2 Materials & Methods

Anopheles gambiae s.s. SUA strain (section 2.1.1) and *An. quadriannulatus* SANGQUA strain (section 2.1.3) were tested in the olfactometer simultaneously (sections 2.2, 2.4 & 2.5). *Anopheles gambiae* s.s. mosquitoes were colour marked with a yellow fluorescent dust for easy identification (section 2.1.4).

4.2.3 Results

Ten replicates of each experiment were performed, resulting in 1200 *An. gambiae* s.s. and 1200 *An. quadriannulatus* tested, of which 91% and 85.5% respectively left their release cages and entered the flight chamber. The mean percentage response (i.e. the mean number of mosquitoes entering traps of the total number that left the release cages) of *An. gambiae* s.s. was lower than in previous experiments (47.25%) as was the mean percentage response of *An. quadriannulatus* (6.25%). There was no significant effect of day or treatment (i.e. odour combination) on the total number of *An. quadriannulatus* responding (ANOVA, $P > 0.05$). However, there was a significant treatment effect (ANOVA, $P < 0.05$) and a significant day effect (ANOVA, $P \leq 0.01$) on the total number of *An. gambiae* s.s. responding. Results are shown in figure 4.2.

Control experiments with both *An. gambiae* s.s. and *An. quadriannulatus* showed that the olfactometer was symmetrical. There was no significant difference in the number of *An. gambiae* s.s. or *An. quadriannulatus* entering either port in experiments testing human skin washing against a control. Significantly more *An. gambiae* s.s. ($P < 0.001$)

entered the control port when tested against cow skin washing + carbon dioxide, whereas *An. quadriannulatus* showed no preference for either port. Both species showed a similar response when human skin washing was tested against cow skin washing + carbon dioxide, preferring to enter the port containing human skin washing.

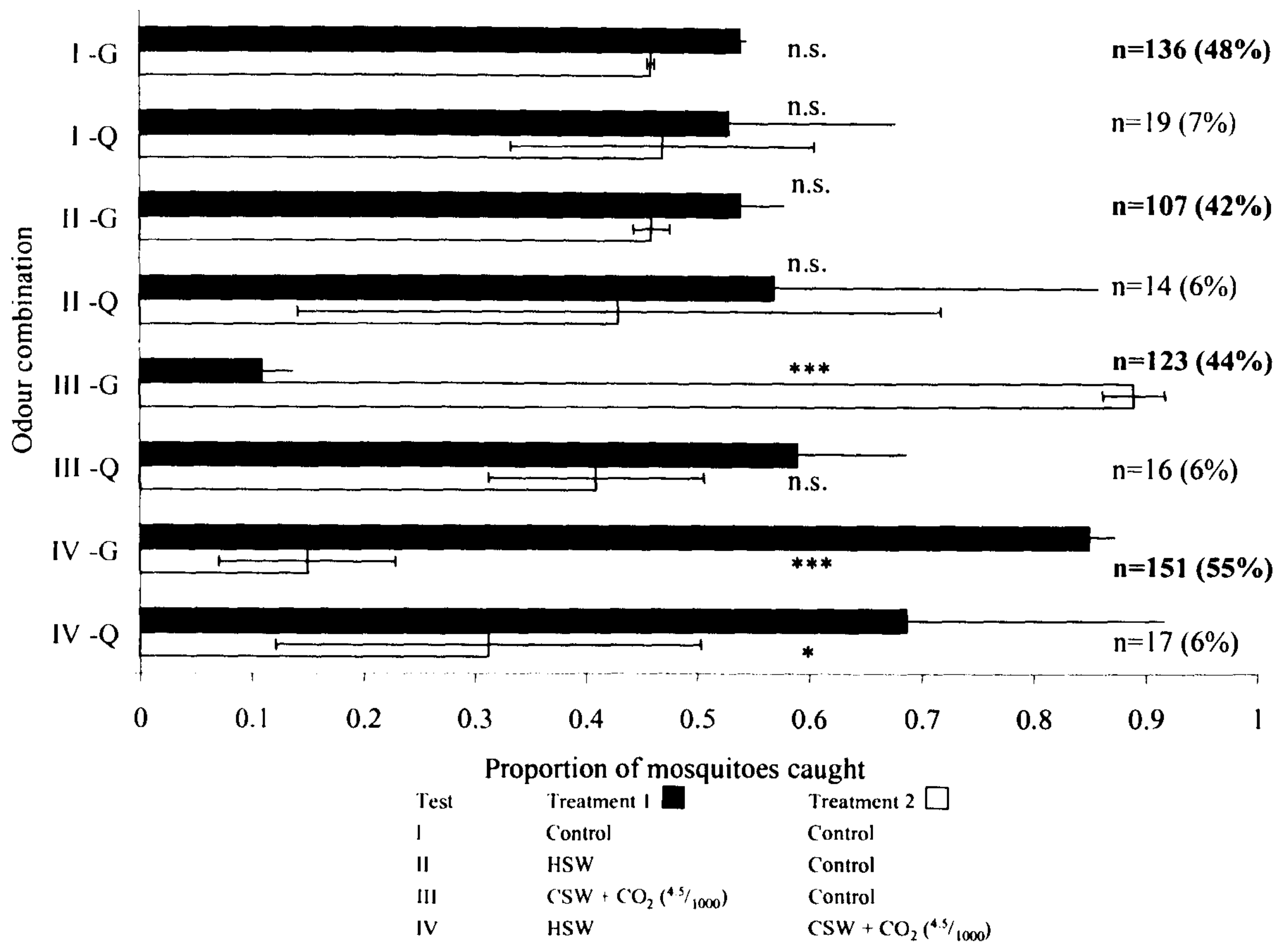

Figure 4.2 Comparison of the catches of *An. gambiae s.s.* and *An. quadriannulatus* with skin washings in the olfactometer. The total proportion of mosquitoes flying into either test port in ten replicate trials is shown. Asterisks mark significant differences between the total number trapped in port 1 and port 2 (χ^2 test: n.s.: $P > 0.05$, $*P < 0.05$, $***P < 0.001$). n= total number of mosquitoes entering both traps (also expressed in parentheses as the percentage mosquitoes caught out of the total number of mosquitoes released after ten replicates). Error bars show 95% confidence limits. The table below the graph indicates the odour combination tested with *An. gambiae s.s.* (G) and *An. quadriannulatus* (Q). Control = ethanol, HSW = human skin washing, CSW + CO₂ (4.5/1000) = cow skin washing + 4.5% carbon dioxide delivered at 1000mlmin⁻¹.

4.2.4 Discussion

The extremely low response of *An. quadriannulatus* to the skin washings makes an accurate interpretation of these results difficult. This again may be a direct consequence of the exophilic character of this mosquito species (see section 3.2 and further discussion in chapter 8). However, the response of *An. gambiae s.s.* to skin washings in these experiments was also low. There were significant differences between the total number of *An. gambiae s.s.* responding on different days which, in addition to the results from the experiment testing human skin washings against a control, indicate that the human skin washing has lost some or most of its activity. It is concluded with the results from these experiments (see also section 4.1) that the human skin washing remains active for approximately 12 months (at 4°C) after which time its activity declines at an unknown rate. It is assumed that the reduced activity of the human skin washing was due to the loss of important volatiles in the mixture. This hypothesis could be tested by preparing fresh human skin washings using the methods described in section 4.1.2 and comparing the fresh human skin washing with the 'old' human skin washing using gas chromatography. This would also help to identify the most important components in the human skin washing.

When human skin washing was tested against cow skin washing + carbon dioxide, similar results to those in the evaluation experiments (section 4.1) were obtained. *Anopheles quadriannulatus* responded in a similar way to *An. gambiae s.s.* (both species preferring to enter the human skin washing port). This preference was also observed when human skin emanations from a stocking which had been worn by a human were tested against cow skin emanations + carbon dioxide (sections 3.1 & 3.2). It is possible that *An. quadriannulatus* was still capable of detecting the human odour in the skin washing but *An. gambiae s.s.* exhibited mainly avoidance behaviour and therefore significantly more entered the human skin washing port.

Anopheles gambiae s.s. preferred to enter the control port than ports containing cow skin washing + carbon dioxide, as was observed when cow skin emanations + carbon dioxide were tested (figure 3.1.3, test IV). *Anopheles quadriannulatus* showed no preference for the cow skin washing + carbon dioxide or the control port. When cow skin emanations (from a nylon stocking) were tested against a control (figure 3.2.3, test II), significantly more ($P < 0.001$) *An. quadriannulatus* (SKUQUA strain) entered the cow odour + carbon dioxide port. The difference between this result and the result obtained with cow skin washings may be due to the higher response of SKUQUA mosquitoes in the skin emanation experiments (41% compared to 6% in skin washing experiments). The

higher response of SKUQUA mosquitoes may also be a result of laboratory adaptation since this strain had been laboratory reared eighteen months longer than the SANGQUA strain at the time of testing. Nevertheless, it is clear that the cow skin washing was still effective since *An. gambiae s.s.* consistently preferred not to enter ports containing cow skin washing + carbon dioxide.

In conclusion, the only experiment to show a difference in the behaviour of *An. gambiae s.s.* and *An. quadriannulatus* was the experiment testing cow skin washing + carbon dioxide against a control (see also figure 3.2.3). Both strains of *An. quadriannulatus* tested in previous experiments (sections 3.2, 3.3 & 3.4) showed a tendency to bite humans or were attracted to human odour. However, the previous studies and the current one clearly showed that *An. quadriannulatus* is much more zoophilic than *An. gambiae s.s.*. Therefore, cow skin washing + carbon dioxide tested against a control was chosen as the bioassay to be used in the crossing experiments discussed in chapter 5. This odour combination was used in order to attempt to distinguish between mosquitoes showing *gambiae*-like behaviour and mosquitoes showing *quadriannulatus*-like behaviour.

Chapter 5

HYBRIDISATION STUDIES TO MODIFY THE HOST PREFERENCE OF *ANOPHELES GAMBIAE*

5.1 Introduction

Much of the research into genetic manipulation of the mosquito genome to decrease vector competence has concentrated on genes that block development of the malaria parasite (for example Severson *et al.*, 1995; Vernick *et al.*, 1995; Feldmann *et al.*, 1998; Collins *et al.*, 1999). An alternative strategy would be to use the genes involved in animal biting (zoophily), which could overcome two problems, namely selection for genes in the parasite which evade the blocking genes in the mosquito and objections to the release of insects into the wild that bite people. *Anopheles gambiae s.s.* and *An. quadriannulatus* appeared to be ideal candidates for such research since it is possible to cross-mate these sibling species and obtain fertile female hybrids (Davidson, 1964 a, b; Davidson *et al.*, 1967), *An. gambiae s.s.* has been shown to be highly anthropophilic (see section 3.1) and *An. quadriannulatus* was considered to be completely zoophilic (Dekker & Takken, 1998; Dekker *et al.*, 2001a). However, olfactometer studies (sections 3.2 & 3.4) and a semi-field study (section 3.3) have shown that *An. quadriannulatus* is not as zoophilic as had been previously thought. Nevertheless, the behaviour of *An. quadriannulatus* remained significantly different from *An. gambiae s.s.* (fig. 3.2.3 & section 4.2) to justify cross-mating experiments and further backcrossing experiments involving these two sibling species. The purpose of these experiments was to investigate the possibility of altering the behaviour of *An. gambiae s.s.* by hybridisation with *An. quadriannulatus*.

Extensive cross-mating experiments among sibling species of the *An. gambiae* complex were carried out by Davidson (1964a, b) who showed that *An. quadriannulatus* species A females crossed with either male *An. gambiae s.s.* or *An. arabiensis* resulted in a marked excess of males that seemed partially fertile (some mature spermatozoa were present in the testes and there was some hatching of F₂ eggs). The reciprocal of these crosses produced sterile hybrid males and a normal sex ratio (see table 5.1). Crosses between *An. gambiae s.s.* or *An. arabiensis* males and *An. melas*, *An. merus* or *An. quadriannulatus* species A females usually resulted in predominantly male offspring. Furthermore, counts of eggs laid and percentage hatching from these crosses showed a consistent less than 50% hatch and unhatched eggs exhibited no obvious signs of embryonic development (Davidson *et al.*, 1967). Davidson and Hunt (1973) performed

crosses with *An. bwambae* and several members of the *An. gambiae* complex and obtained no obviously distorted sex ratios. However, crosses between *An. bwambae* males and *An. quadriannulatus* species A females (from Zimbabwe) produced hybrid males with an apparently normal reproductive system with numerous mature spermatozoa. Further evidence of the fertility of these hybrid males was obtained from hatching of F₂ eggs laid by hybrid females mated with F₁ males. The reciprocal cross (*An. quadriannulatus* species A males mated with *An. bwambae* females), produced an almost sterile male hybrid with reduced testes showing little or no spermatogenesis; several hundred F₂ eggs were laid but only one hatched. Hunt *et al.* (1998) crossed *An. quadriannulatus* species A females from South Africa with *An. quadriannulatus* species B males from Ethiopia and obtained a distorted sex ratio, with more females in the F₁ generation than males. However, hybrid males from this cross were completely sterile with testes showing a type II abnormality (see section 5.2.3 & table 5.1).

Table 5.1. Percentage of males and degree of sterility in the F₁ generation resulting from crosses between *Anopheles quadriannulatus* species A and other members of the *An. gambiae* complex.

Crosses ¹		% males in F ₁ generation	Testis type ²	Appearance of spermatozoa	F ₂ egg hatch
Male	Female				
<i>gambiae</i>	<i>quadriannulatus</i> species A	87	III	Immature and mature spermatozoa present	Very few
<i>arabiensis</i>	<i>quadriannulatus</i> species A	81	III	Some mature spermatozoa present	Very few
<i>quadriannulatus</i> species A	<i>gambiae</i>	47	II	Mostly undifferentiated germ cells and immature spermatozoa	Not done
<i>quadriannulatus</i> species A	<i>arabiensis</i>	52	II	Mostly undifferentiated germ cells and immature spermatozoa	Not done
<i>merus</i>	<i>quadriannulatus</i> species A	39	IV	Undifferentiated germ cells	Not done
<i>quadriannulatus</i> species A	<i>merus</i>	43	III	Mix of germ cells and immature and mature spermatozoa	Not done
<i>melas</i>	<i>quadriannulatus</i> species A	40	IV	Undifferentiated germ cells	Not done
<i>quadriannulatus</i> species A	<i>melas</i>	39	III	Mix of germ cells and immature and mature spermatozoa	Not done
<i>bwambiae</i>	<i>quadriannulatus</i> species A	48	normal	Numerous mature spermatozoa	Many
<i>quadriannulatus</i> species A	<i>bwambiae</i>	46	II	Mostly undifferentiated germ cells and immature spermatozoa	<1%
<i>quadriannulatus</i> species B	<i>quadriannulatus</i> species A	32	II	Undifferentiated germ cells	Not done

¹Results of crosses between *An. quadriannulatus* species A (Zimbabwe) and *An. gambiae* s.s. (Nigeria), *An. arabiensis* (Tanzania), *An. merus* (Tanzania), *An. melas* (Liberia) from Davidson (1964a). Results of crosses between *An. quadriannulatus* species A (Zimbabwe) and *An. bwambiae* (Uganda) from Hunt & Davidson (1973). Results of cross between *An. quadriannulatus* species A (South Africa) with *An. quadriannulatus* species B (Ethiopia) from Hunt *et al.* (1998).

²Type of testis abnormality as classified by Davidson *et al.* (1967):

- (I) Testis partially reduced in size, dark brown containing mostly undifferentiated germ cells & immature spermatozoa; vas efferens typically broad & short.
- (II) Testis pale & reduced or very reduced in size containing only undifferentiated germ cells; vas efferens usually long & slender.
- (III) Testis normal in size & general appearance (as is vas efferens), containing mix of germ cells & immature & mature spermatozoa (very few F₂ eggs hatch from controlled matings between such males and virgin females).
- (III) Whole reproductive system reduced in size, including accessory glands. Testis is tiny, elongated body containing only undifferentiated germ cells; vas efferens is short and broad.

5.2 Materials & Methods

5.2.1 Crosses with *Anopheles quadriannulatus*

A 'mass-cage cross' between *An. quadriannulatus* females and *An. gambiae s.s.* males was attempted 3 times (H.V. Pates, Department of Entomology, Wageningen University) but no eggs were obtained from females. *Anopheles quadriannulatus* is a notoriously difficult mosquito to rear in the laboratory (Coluzzi & Sabatini, 1968; Davidson, 1964a; Mpofo *et al.*, 1993; Takken *et al.* (2001); section 2.1) and this is probably the reason for the failure of this cross. Use of the artificial mating technique may have produced eggs, but in view of the results obtained by Davidson (1964a) mentioned above, use of this technique to obtain hybrid females was considered far too labour intensive to be pursued in the present study. Therefore, in both study 1 and study 2 (see section 5.2.2), *An. gambiae s.s.* females were crossed with *An. quadriannulatus* males in a 'mass cage cross'. Several parameters in the resulting progeny from such a 'mass cage cross' and 'mass cage crosses' of mosquitoes backcrossed to either *An. gambiae s.s.* or *An. quadriannulatus* were considered in order to check the viability of the progeny. The number of male and female progeny and % egg hatch from these crosses and backcrosses to both parents are shown in table 5.2. The sex ratios of hybrids resulting from the cross and further backcrosses to either parent were normal or near normal. However, significantly fewer males resulted from both the first and second backcrosses to *An. quadriannulatus* in study 1 and study 2 and the first backcross to *An. gambiae s.s.* in study 1. A significantly higher number of males were observed in the hybrid generation in study 1 but not in study 2. The majority of eggs hatched, although the percentage varied depending on the mating (80-93% hybrid eggs hatched; 75% eggs from the 2nd backcross to *An. gambiae s.s.* hatched compared to 91% of eggs from the 1st backcross to *An. gambiae s.s.*; 88-89% eggs from both backcrosses to *An. quadriannulatus* hatched). In study 2, there was no significant difference between the number of hybrid eggs hatched or the number of hatched eggs from the first backcross to either *An. gambiae s.s.* or *An. quadriannulatus* and the number of eggs hatched by pure *An. gambiae s.s.*. In study 1 there was no significant difference between the percentage egg hatch observed between hybrids and *An. quadriannulatus*. Adult eclosion from pupae (study 2) was high (92-96% survival), which was a good indication that the method of placing pupae in glass vials before adult emergence did not harm the pupae in any way.

5.2.2 Production of hybrids and backcrosses

Anopheles gambiae s.s. x *An. quadriannulatus* hybrids were produced by performing mass crosses in cages. Two plastic buckets (height 25cm) were set up in an insectary at $27 \pm 1^\circ\text{C}$, 80% relative humidity and a 12-hour scotophase with a 30 minute dusk/dawn period to allow for mating. Sixty 2-7 day old *An. quadriannulatus* (SANGQUA) males and 30 one day old *An. gambiae s.s.* virgin females were added to each cage, provided with a 6% glucose solution and left to mate. After 3 days, females were given several opportunities to take a bloodmeal from a human arm. Damp filter paper cones were provided for oviposition and larvae were reared as for *An. quadriannulatus*. The filter paper strips were removed from the trays when the first pupae appeared and eggs were counted to investigate the percentage that did not hatch. In study 1, pupae were placed collectively in a dish inside a cage; hybrid adult females were removed within 24 hours of emergence and placed in a separate cage. In study 2, pupae were removed daily and each was placed individually in a glass vial with a small amount of water and a cotton wool bung. This allowed easy separation of males from females once the adults had emerged and ensured that the hybrid females could not mate with sterile hybrid males. Males, females and any dead pupae were counted. A random selection of male hybrids (at least 4 days old) were dissected to investigate the extent of their sterility.

Two studies were undertaken to investigate the possibility of altering the behaviour of *An. gambiae s.s.* by crossing genes from *An. quadriannulatus* into it.

i) Study 1 (fig. 5.1)

AIM: to investigate the behaviour of F₁ species hybrids and effect of selecting zoophilic individuals among the F₁ and backcrossing to either parent.

Hybrid virgin females were placed in buckets and mated either with *An. quadriannulatus* (SANGQUA) males or *An. gambiae s.s.* males. Females were then tested in the olfactometer, anthropophilic responders were discarded while zoophilic responders were selected and returned to their cages and given several opportunities to take a bloodmeal from a human arm (unfortunately, mosquitoes would not feed from a membrane feeder and therefore a human arm had to be used). Eggs, larvae and pupae were reared as before. Adults from the resulting backcross to *An. quadriannulatus* or *An. gambiae s.s.* were then subjected to behavioural tests in the olfactometer. Colour marked *An. gambiae s.s.* females of the same age were released in the olfactometer on the

same day that the behavioural tests took place to check for bias in the olfactometer and act as a reference.

ii) *Study 2* (fig.5.2)

AIM: to investigate the behaviour of mosquitoes over three generations of backcrossing to either parent (without selection among the F₁ hybrids).

At the start of these series of backcrosses the F₁ hybrids were not selected in the olfactometer (the F₁ hybrids were expected to be genetically uniform). F₁ virgin females were placed into two cages; one containing *An. gambiae s.s.* males, the other *An. quadriannulatus* (SANGQUA) males. After 3 days, females were given several opportunities to take a bloodmeal from a human arm. Eggs, larvae and pupae were reared as before. Eggs from the backcrosses were counted to investigate the percentage that did not hatch and a random selection of males from the backcrosses to *An. gambiae s.s.* and to *An. quadriannulatus* (SANGQUA, at least 4 days old) were dissected to investigate the extent of their sterility. Females from the backcross to *An. quadriannulatus* were placed in buckets and mated with *An. quadriannulatus* males and females from the backcross to *An. gambiae s.s.* were mated to *An. gambiae s.s.* males. Thus two distinct lines of backcrossing were set up, one to each parental species. Before breeding from the females they were subjected to behavioural tests in the olfactometer. Backcrossed mosquitoes that responded to zoophilic odour cues were returned to their cages and given several opportunities to take a bloodmeal from a human arm (unfortunately, mosquitoes would not feed from a membrane feeder and therefore a human arm had to be used). The same procedure as for the first backcross was followed. In total, three generations in each line of backcrossing were reared and tested in the olfactometer. Each olfactometer test was controlled by release of colour marked *An. gambiae s.s.* females of the same age into the olfactometer on the same day as the behavioural tests took place to check for bias in the olfactometer and act as a reference.

Table 5.2. Percentage egg hatch, adult eclosion and sex ratios from crosses between female *An. gambiae s.s.* and male *An. quadriannulatus* and from backcrosses.

STUDY 1					
Mating	Total number eggs counted	% hatched (1)		% males (2)	N ^o . sexed adults
<i>gambiae</i> x <i>quadriannulatus</i>	626	80 ^b		53 ^{**}	2074
1 st backcross to <i>gambiae</i>				47 [*]	1270
2 nd backcross to <i>gambiae</i>				57 ^{ns}	138
1 st backcross to <i>quadriannulatus</i>				44 ^{***}	1103
2 nd backcross to <i>quadriannulatus</i>				43 [*]	292
STUDY 2					
Mating	Total number eggs counted	% hatched (1)	Adult eclosion (3)	% males (2)	N ^o . sexed adults
<i>gambiae</i> x <i>quadriannulatus</i>	2448	93 ^a	94	50 ^{ns}	1215
1 st backcross to <i>gambiae</i>	2504	91 ^a	96	49 ^{ns}	1470
2 nd backcross to <i>gambiae</i>	147	75 ^b	94	49 ^{ns}	1427
3 rd backcross to <i>gambiae</i>			95	49 ^{ns}	902
1 st backcross to <i>quadriannulatus</i>	2492	89 ^a	92	43 ^{***}	1543
2 nd backcross to <i>quadriannulatus</i>	85	88 ^{a,b}	95	46 ^{**}	1295
3 rd backcross to <i>quadriannulatus</i>			94	50 ^{ns}	844
<i>An. gambiae s.s.</i>	1874	92 ^a			
<i>An. quadriannulatus</i>	1947	82 ^b			

(1) Different letters indicate significant differences between % eggs hatched (χ^2 , $P < 0.05$).

(2) Deviations from a normal sex ratio (tested using a χ^2 test) are indicated as follows: ns = not significant, *** $P < 0.001$, ** $P < 0.01$, * $P < 0.05$.

(3) % adult eclosion from pupae was observed in study 2 only.

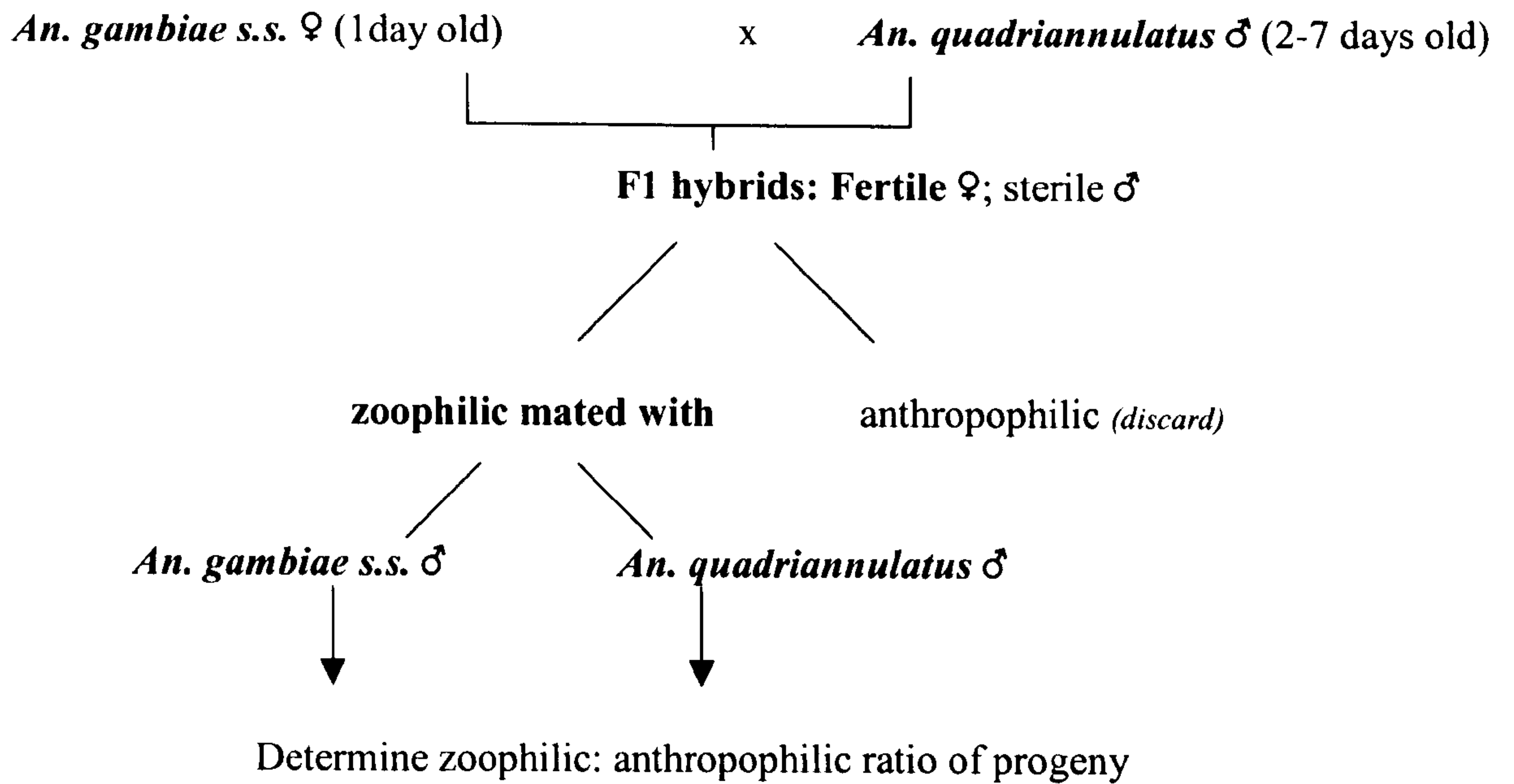

Figure 5.1. Procedure for cross-mating *An. gambiae s.s.* and *An. quadriannulatus* (SANGQUA), selection of zoophilic F₁ individuals, backcrossing to each parental species and testing the 1st backcross progeny.

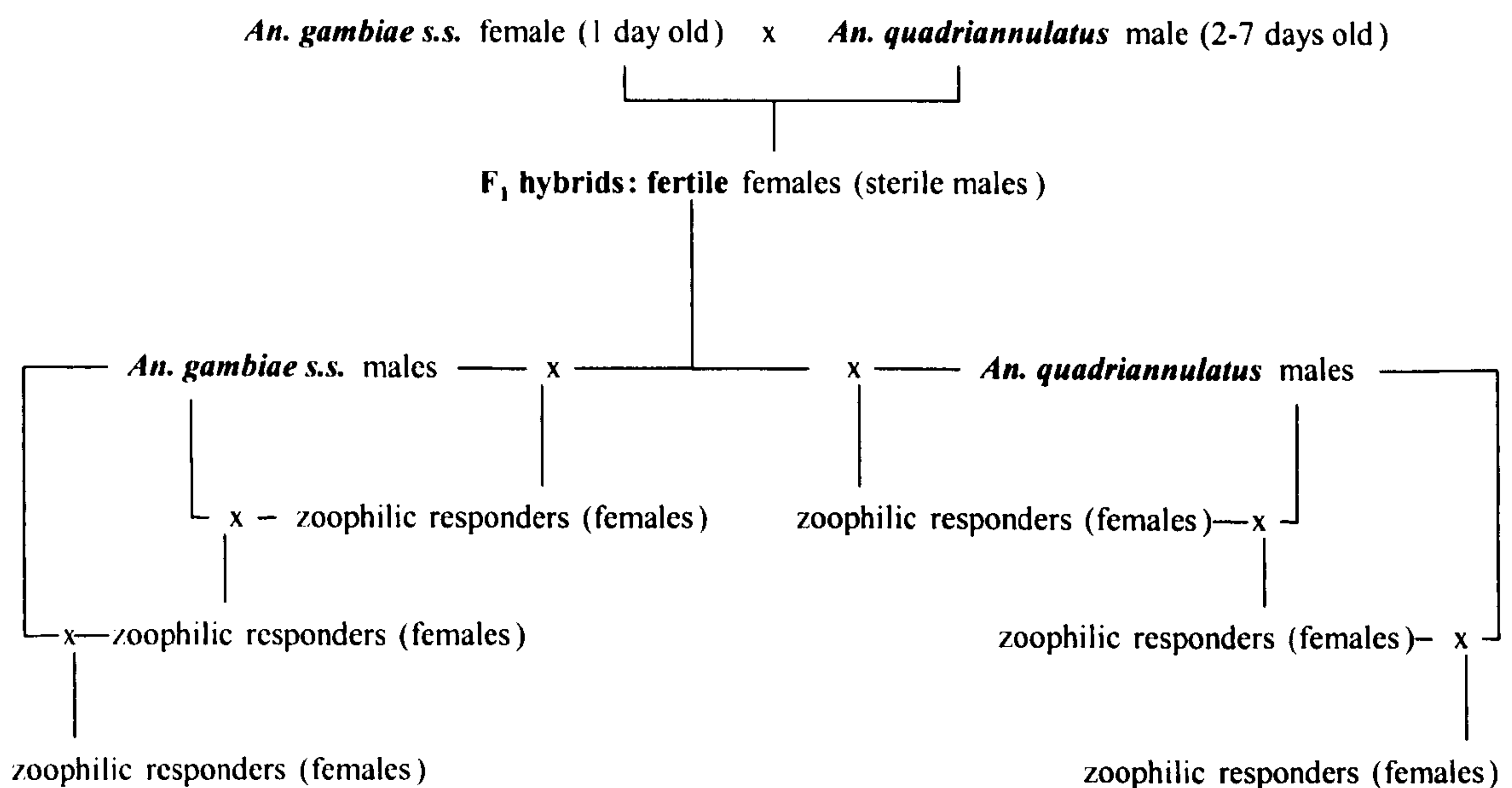

Figure 5.2. Procedure for cross-mating *An. gambiae s.s.* and *An. quadriannulatus* (SANGQUA) and 3 generations of backcrossing to each parental species.

5.2.3 Hybrids and hybrid male sterility

The testes are largely covered with fat body and are situated dorso-laterally in the 5th and 6th abdominal segments. Their anterior ends are pointed and end in terminal filaments of connective tissue which are attached to the heart and alary muscles (Clements, 1963). The normal male testis is a brown, pear shaped bulbous body, equal in size or slightly larger than the accessory gland and contains undifferentiated germinal tissue distally and coiled mature spermatozoa proximally (that extend into the lumen of the vas efferens) (see figures 5.3 & 5.4). The mature spermatozoa readily spread out when the testis is ruptured. The testis of a male hybrid from an *An. gambiae s.s.* x *An. quadriannulatus* cross is pale or colourless, very reduced in size (sometimes appearing to be completely absent) and contains only circular spermatids (see figures 5.5 & 5.6). There is no sign of spermatogenesis and the vas efferens appears to be longer and narrower than that of *An. gambiae s.s.* or *An. quadriannulatus*. This type of testis abnormality was categorised by Davidson *et al.* (1967) as a 'type II abnormality', also typical of hybrids resulting from a cross between *An. arabiensis* males and *An. gambiae s.s.* females.



Figure 5.3. The normal male reproductive system of *An. gambiae s.s.* (negative = x100). T = testis; A = accessory gland; VD = vas deferens; VE = vas efferens. The pale area of the testes represents the section where undifferentiated germinal cells are found.

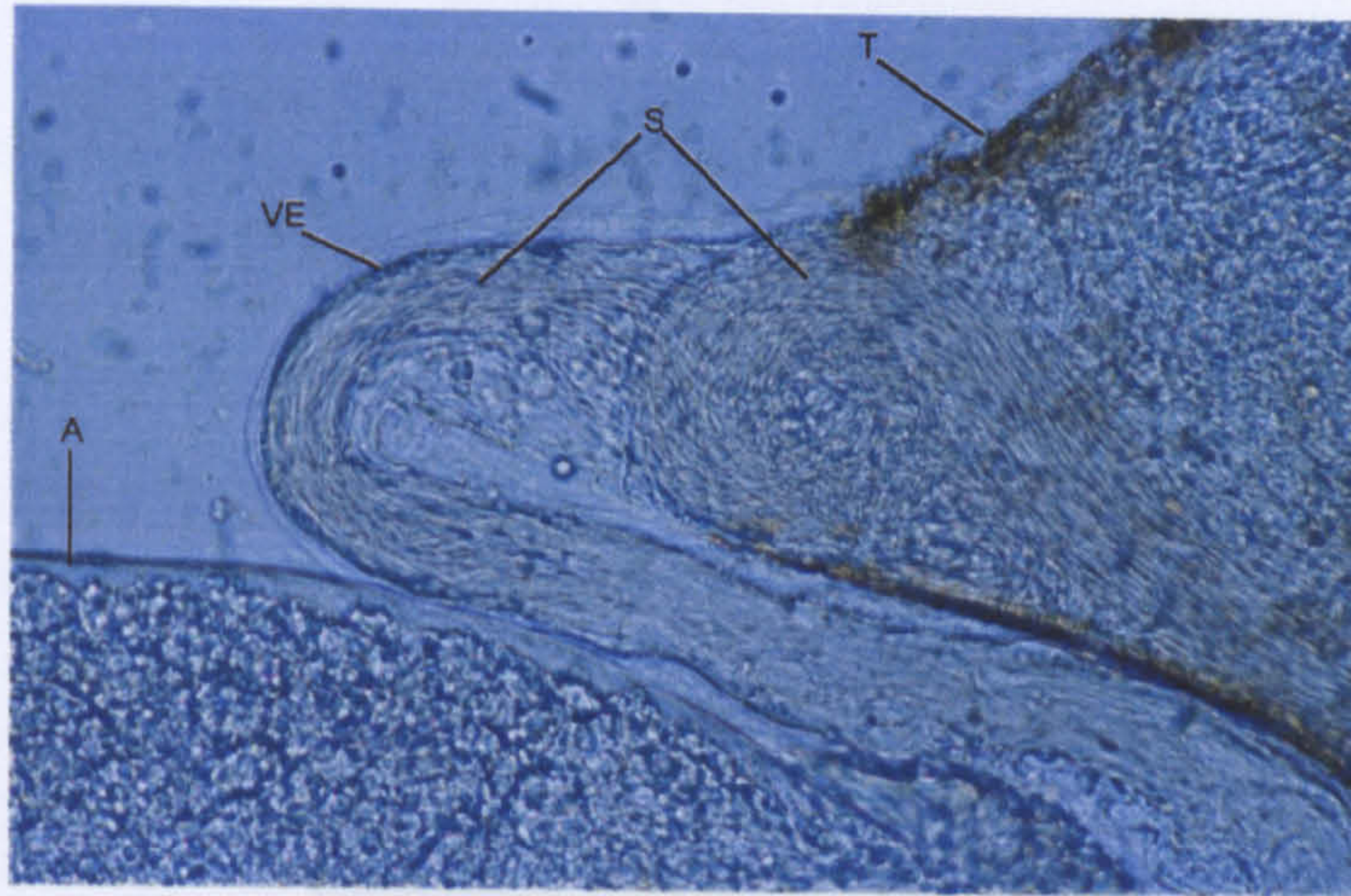

Figure 5.4. View of vas efferens / testis junction containing coils of mature spermatozoa (negative = x1000) in *An. gambiae s.s.*. T = testis; A = accessory gland; VE = vas efferens; S = spermatozoa.

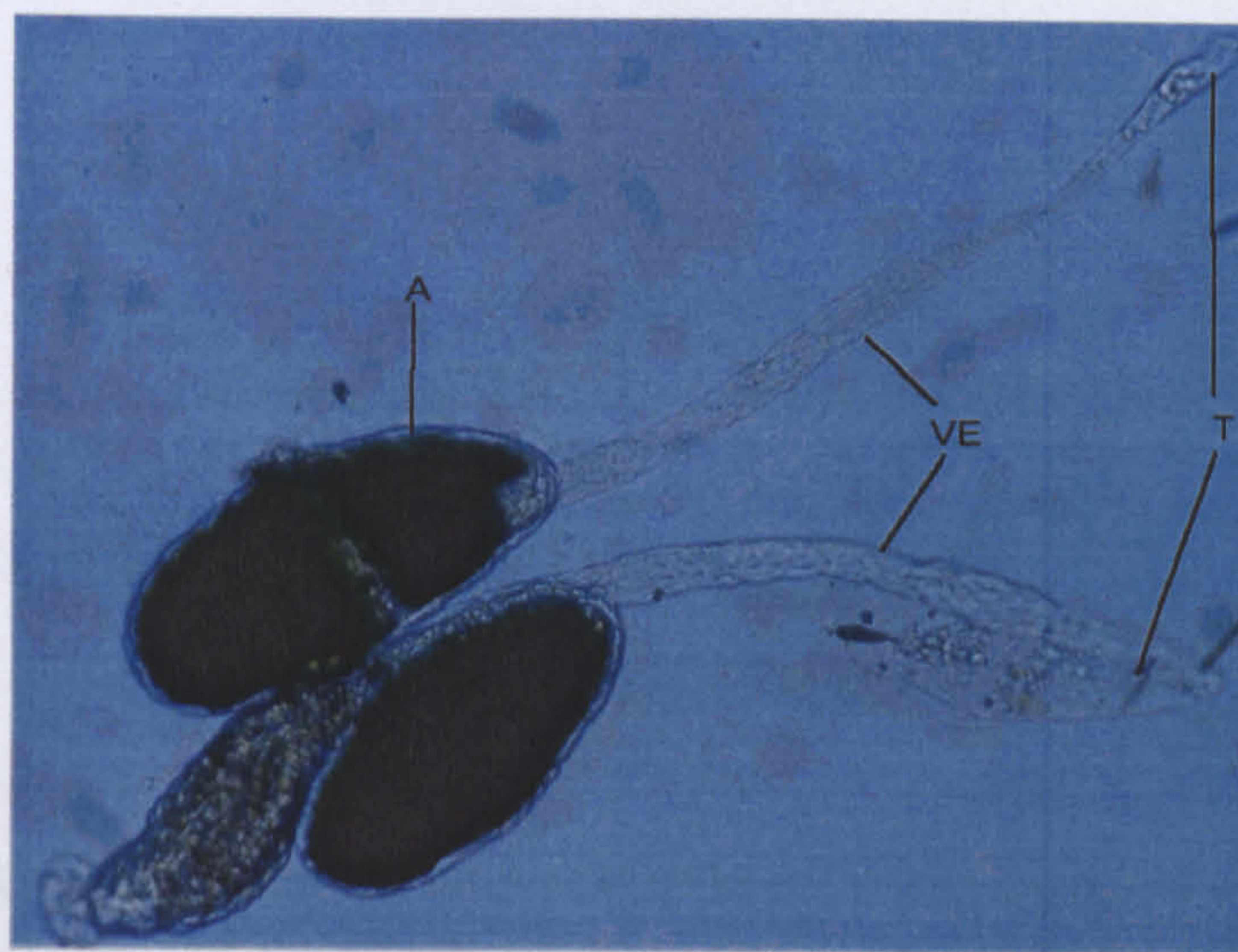

Figure 5.5. The male reproductive system of an *An. gambiae s.s.* x *An. quadriannulatus* hybrid (negative = x100). T = testis; A = accessory gland; VE = vas efferens.

The majority of males dissected resulting from hybrid females backcrossed to either *An. gambiae* s.s. or *An. quadrimaculatus* were fertile, possessing testes with an apparently normal appearance (Figures 5.7 – 5.9). Two (of 20 dissected) *An. gambiae* s.s. were completely sterile, possessing a very small and one smaller testis. The colour of the testes of males backcrossed to *An. gambiae* s.s. ranged from colourless (almost colourless) to dark brown; two specimens possessed red pigmented testes and one specimen possessed small areas of bright red pigmentation. Of the males resulting from a 1st backcross to *An. quadrimaculatus*, 10 specimens (of 20 dissected) were completely sterile although four specimens possessed testes with a mixture of many mature spermatozoa and small areas of immature spermatozoa at the base of the testes. Testes of males backcrossed to *An. quadrimaculatus* were brown in colour.

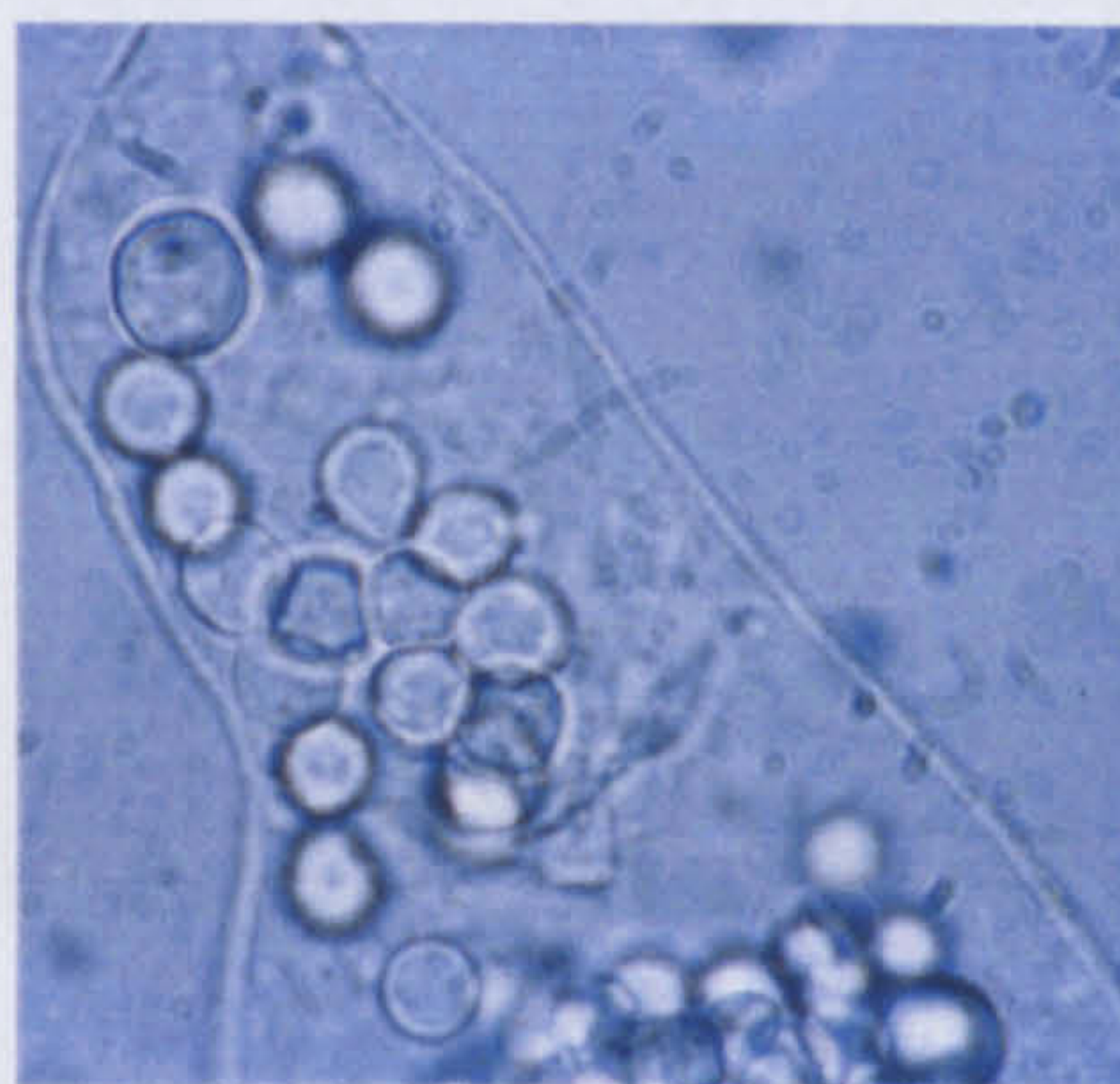
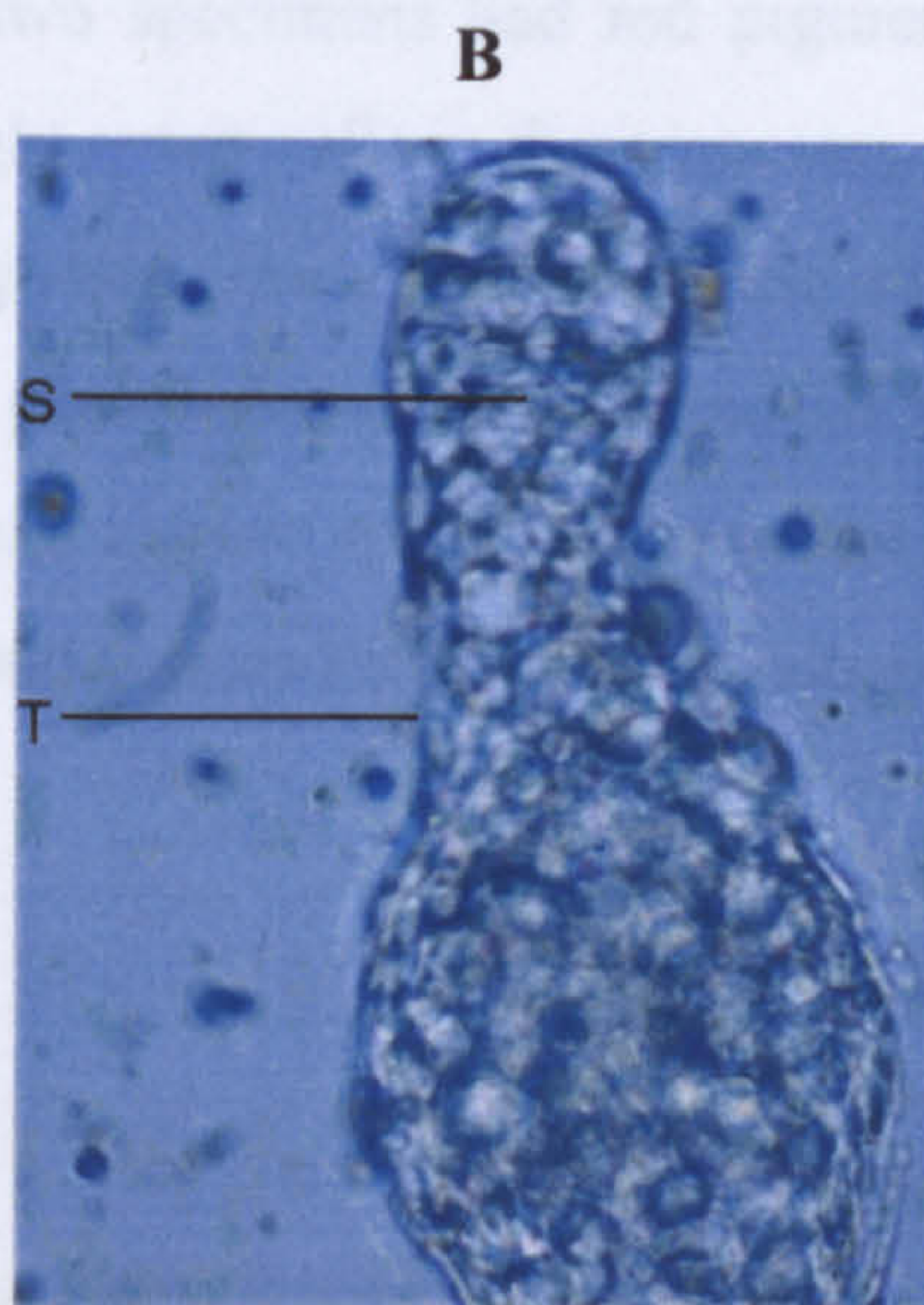
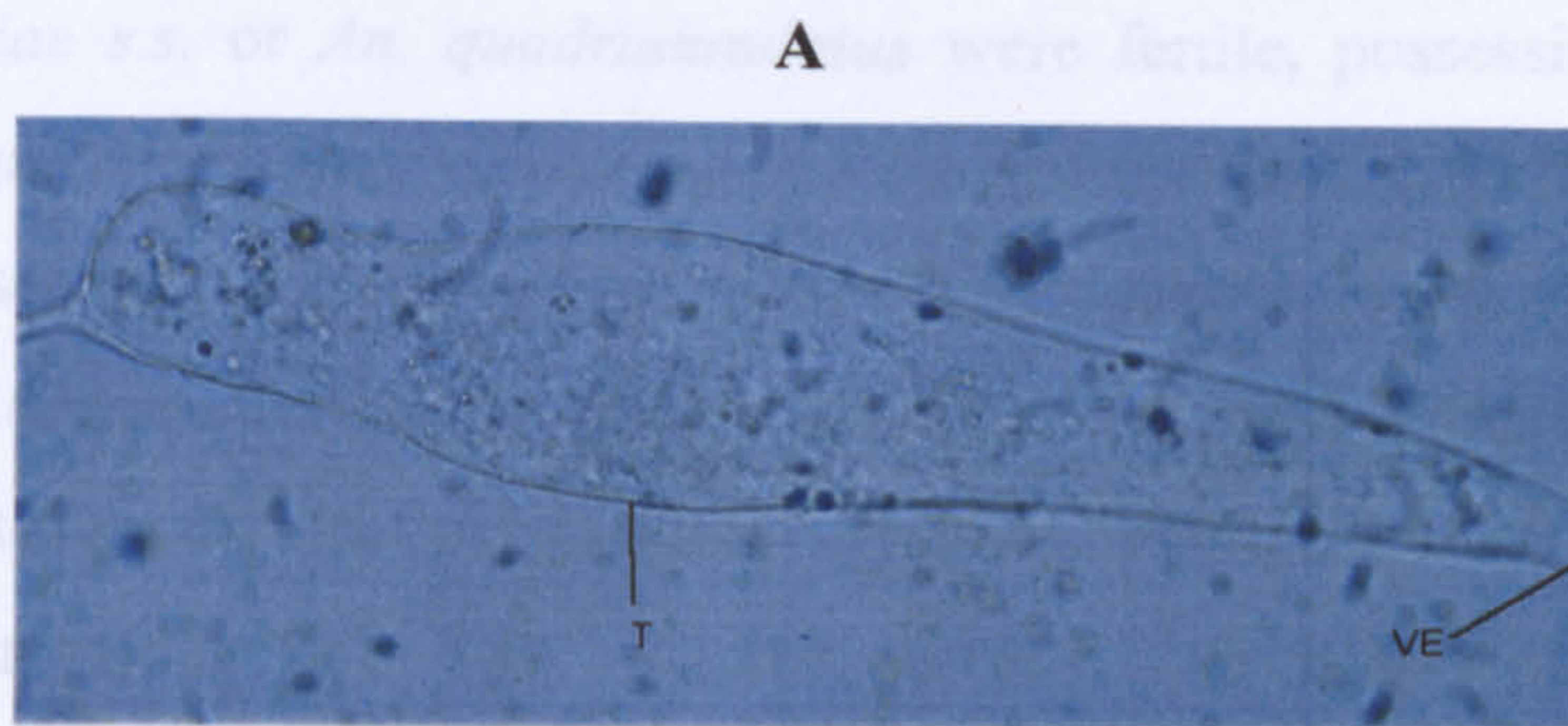

Figure 5.7. The reproductive system of males resulting from a hybrid backcrossed to

Figure 5.6. High power view of male hybrid testis: A) Hybrid testis (negative = x400): elongated and colourless, very few spermatozoa apparent, terminal filament of connective tissue is visible on anterior end; B) Hybrid testes (negative = x400): bulbous shape at anterior end, containing many circular spermatozoa; C) Hybrid testis (negative = x1000): round, circular spermatozoa and immature spermatozoa are clearly visible. T = testis; VE = vas efferens; S = spermatozoa.

The majority of males dissected resulting from hybrid females backcrossed to either *An. gambiae s.s.* or *An. quadriannulatus* were fertile, possessing testes with an apparently normal appearance containing mature spermatozoa (see figures 5.7 – 5.9). Two (of 20 dissected) males resulting from a 1st backcross to *An. gambiae s.s.* were completely sterile, and a further two males possessed one large, apparently normal testis and one smaller testis containing immature spermatids (see figure 5.10). The colour of the testes of males resulting from this backcross ranged from a very pale brown (almost colourless) to dark brown; two specimens had red pigmented testes and one specimen possessed small areas of bright green cells in the accessory glands. Of the males resulting from a 1st backcross to *An. quadriannulatus*, none were completely sterile although four specimens (of 20 dissected) possessed apparently normal testes with a mixture of many immature spermatids and some mature spermatozoa in the lumen of the vas efferens and base of the testes. Testes of males from this backcross were brown in colour.

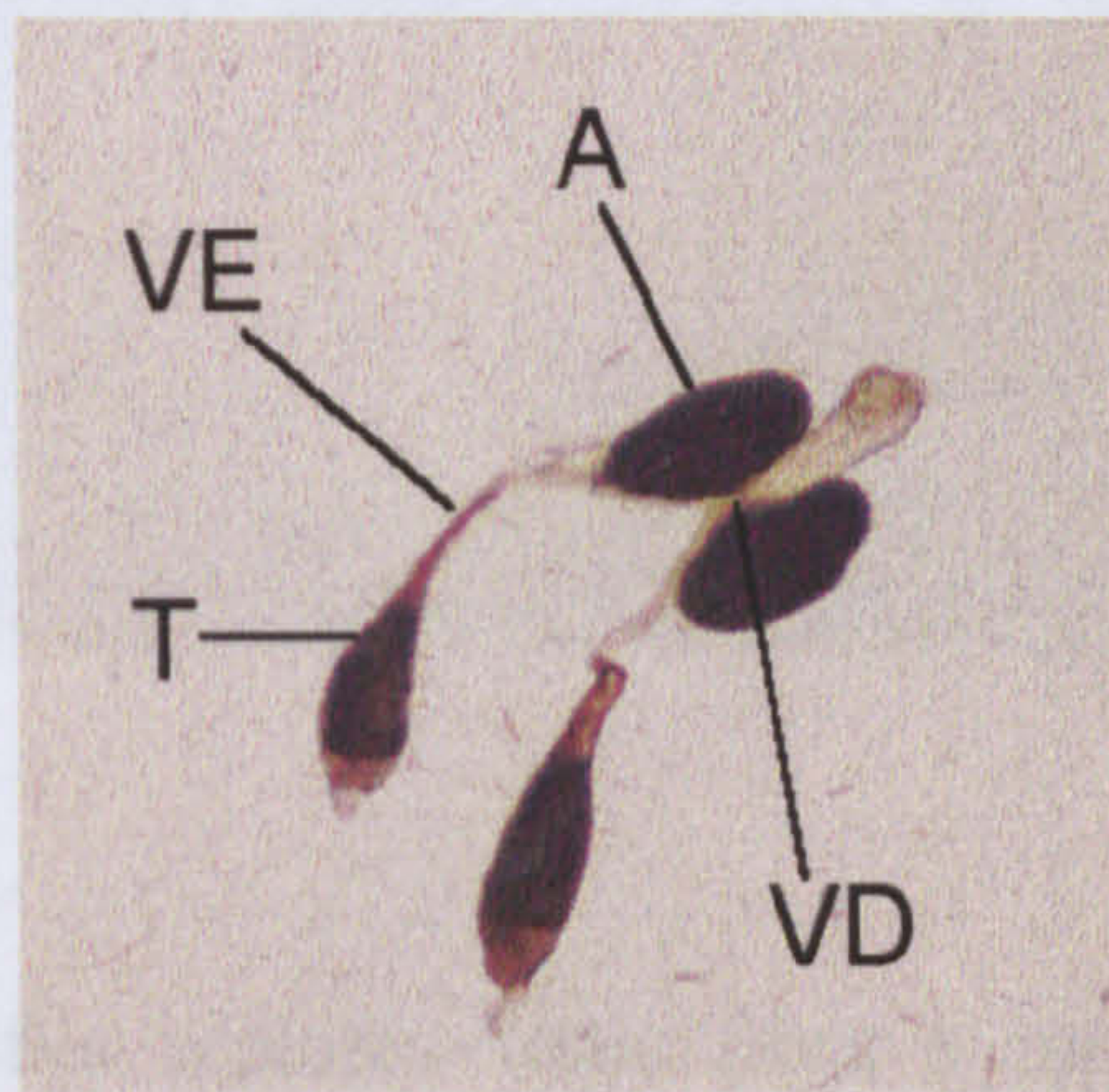
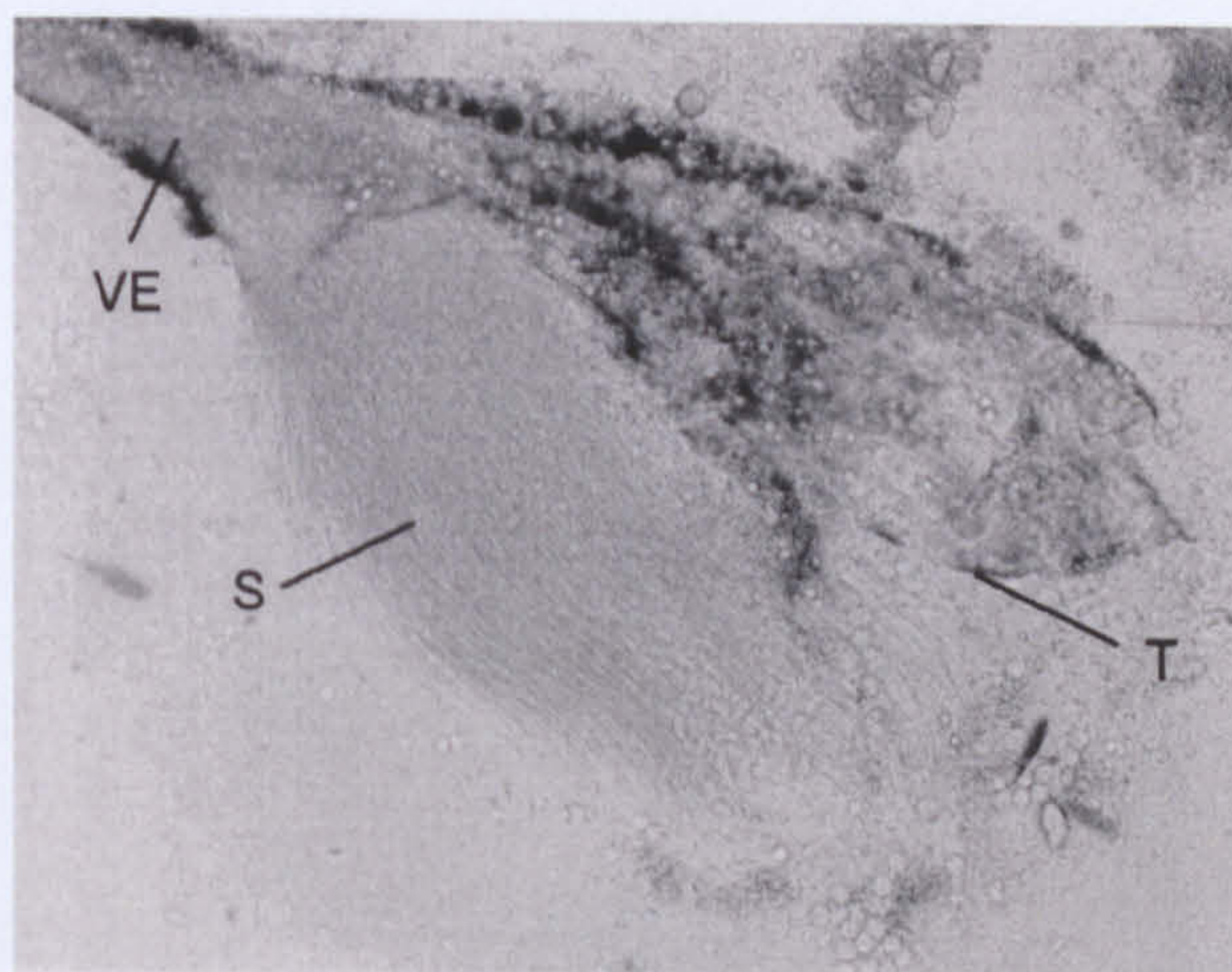

Figure 5.7. (A) View of the reproductive system of a male resulting from a hybrid backcrossed to *An. quadriannulatus* (negative = x25). Mature spermatozoa readily

Figure 5.7. The reproductive system of a male resulting from a hybrid backcrossed to *An. quadriannulatus* (negative = x25). A = accessory gland; VE = vas efferens; VD = vas deferens; T = testis.

A



B

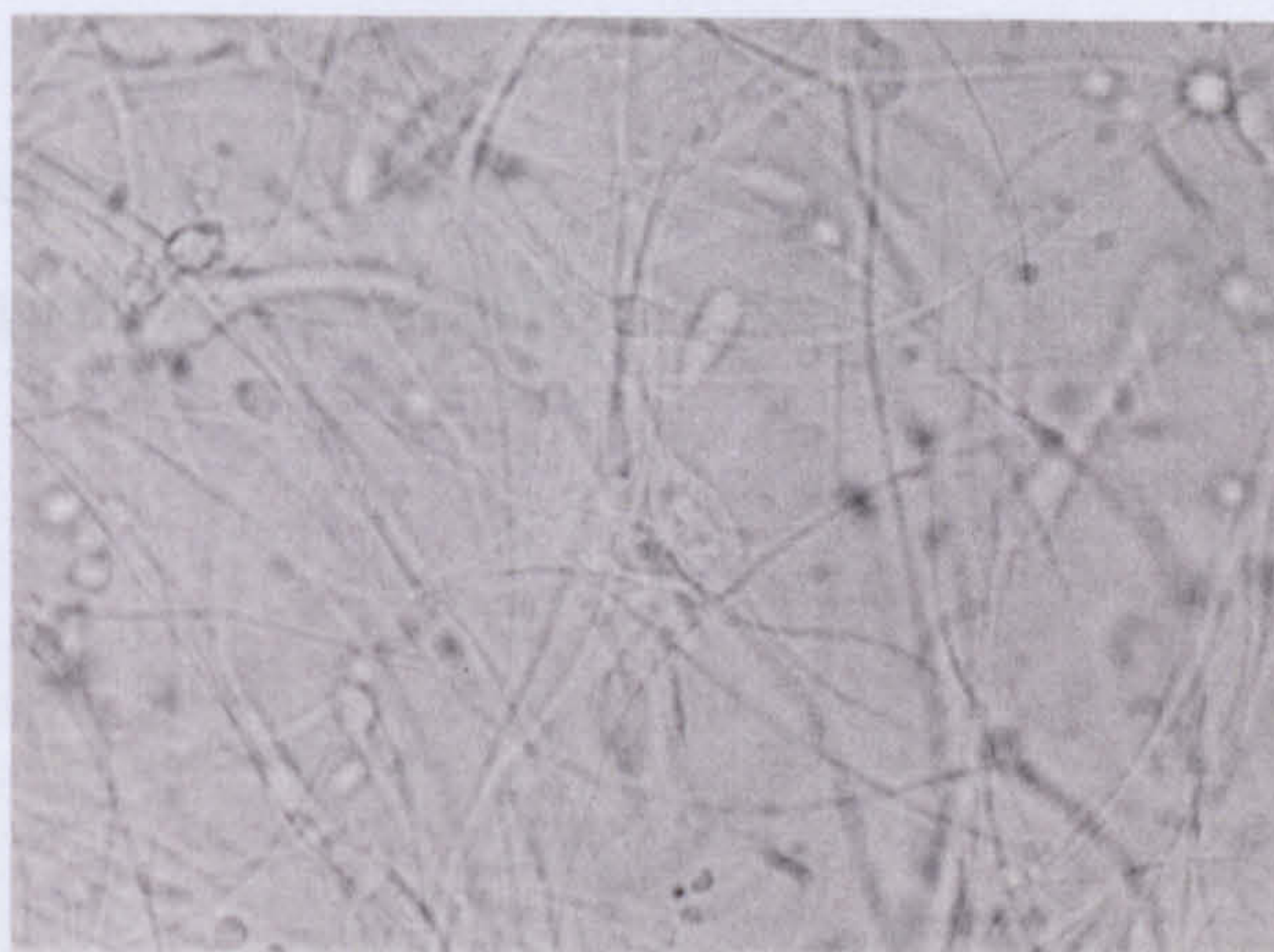

Figure 5.8. (A) View of a ruptured testis from a male resulting from a hybrid backcrossed to *An. quadriannulatus* (negative = x160). Mature spermatozoa readily spread out into the surrounding medium. VE = vas efferens; S = spermatozoa; T = testis. (B) High power view of contents from ruptured testis (negative = x1000).

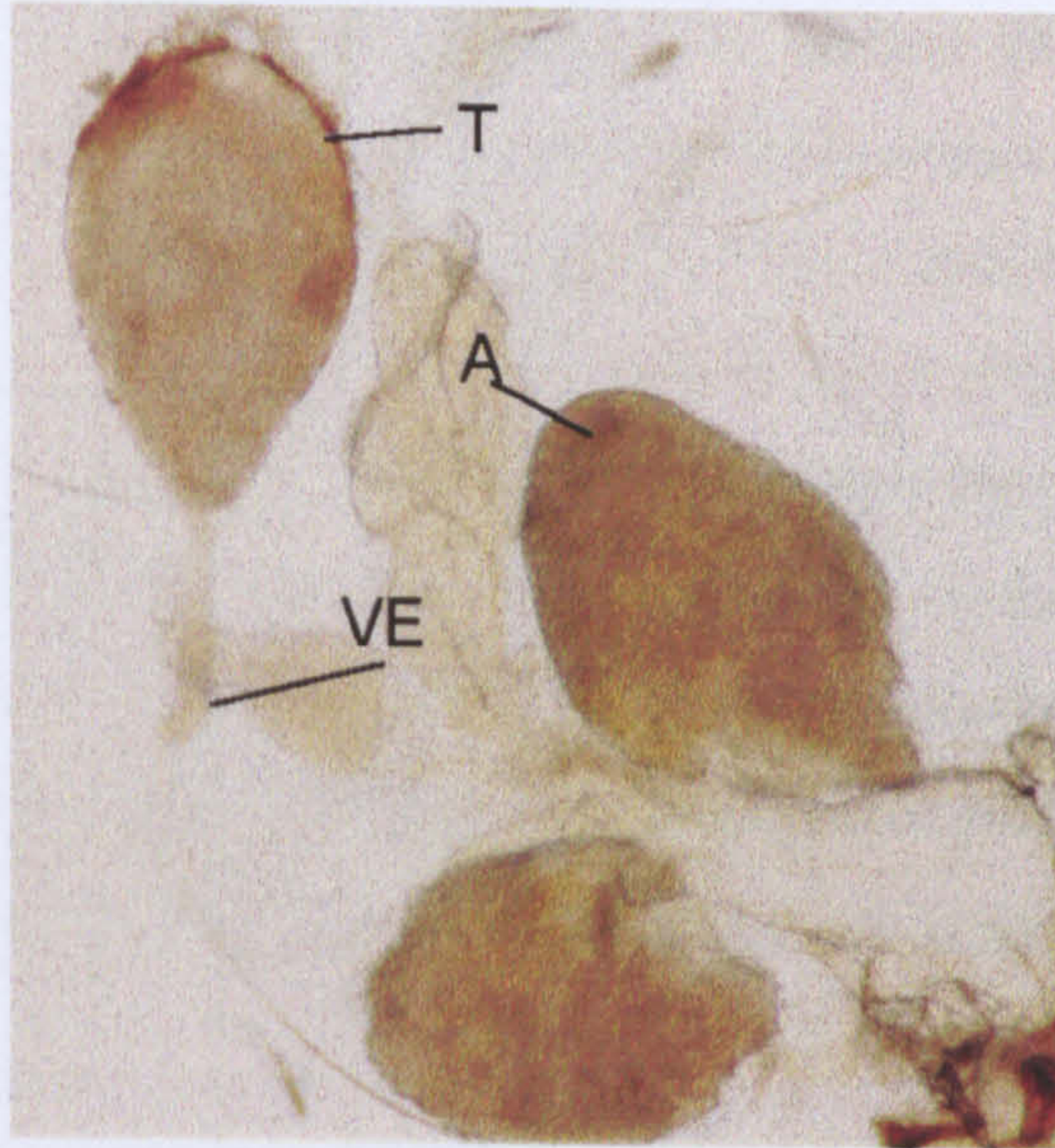

Figure 5.9. The reproductive system of a fertile male resulting from a hybrid backcrossed to *An. gambiae s.s.* (negative = x100). A = accessory gland; VE = vas efferens; T = testis.

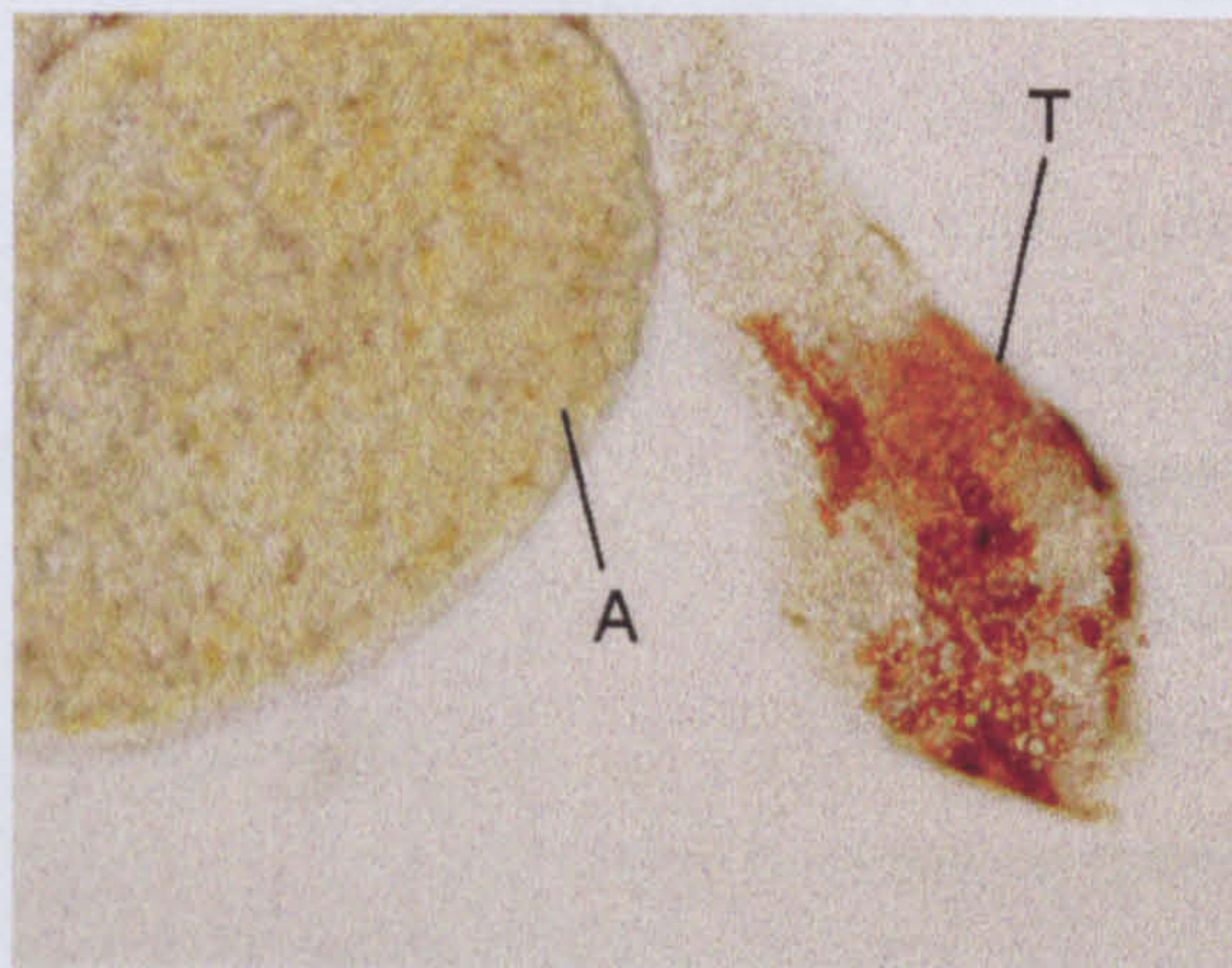

Figure 5.10. A reduced testis containing immature spermatids from a male resulting from a hybrid backcrossed to *An. gambiae s.s.* (negative = x160). A = accessory gland; T = testis.

5.2.4 *Behavioural studies with hybrids and backcrossed mosquitoes*

Mosquitoes from the crossing experiments were tested in the olfactometer (see sections 2.2 & 2.4) using cow skin washing + carbon dioxide (delivered at calf equivalents) against a control (the same quantity of ethanol on a sand blasted glass slide + clean moistened air delivered at 1000mlmin^{-1}). The cross-breeding and subsequent behavioural experiments took place over a period of three months (in both study 1 and study 2), and therefore could not be performed simultaneously (e.g. it was not possible to test mosquitoes from the 3rd backcross to *An. gambiae s.s.* on the same day as mosquitoes from the 2nd backcross to *An. gambiae s.s.*). This might have been a source of bias as there might have been differences between the responses of progeny of a given mating on different days hence the effect of ‘day’ was included in the analysis.

5.2.5 *Data Analysis*

Data from the behavioural experiments in this chapter were analysed in a slightly different manner to behavioural experiments performed in sections 3.2, 3.2, 3.4, 4.1 & 4.2 since in this chapter the same odour combination was used in each test (as opposed to a range of odour combinations used in the sections mentioned above). Differences within the two-choice test (control vs. cow skin washing + carbon dioxide) were analysed with a chi-square test using the total number of mosquitoes caught after a minimum of six replicates. The overall attractiveness of the cow skin washing + carbon dioxide was measured as the ‘zoophilic index’, defined as the proportion of mosquitoes caught by that stimulus of the total number of mosquitoes caught in both traps. These proportions were transformed into arcsines of the square roots for analysis. Normality of results was checked by a goodness of fit test against the expected normal distribution using a residual plot, i.e. a scatter plot where the residual values from the data (i.e. the difference between the observed value and predicted value of a point) are plotted on the vertical axis and predicted values are plotted on the horizontal axis. A residual plot showing a good fit produces residuals with no discernible pattern, often appearing as an oval cloud. Differences between the zoophilic index of each mosquito species or cross progeny were analysed using ANOVA and contrasted by a Tukey test (the effect of ‘day’ on the zoophilic index was also included in the model). A zoophilic index (which could range from 0 to 1) of >0.5 was considered to represent behaviour consistent with mosquitoes that preferred cow odour, whereas a zoophilic index of <0.5 was considered to represent mosquitoes that showed aversion to cow odour.

5.3 Results

There was no significant effect of day on the response of control mosquitoes tested on each testing day in the olfactometer. Experiments with *An. gambiae s.s.* in both study 1 and 2 showed an aversion to cow odour since the majority of mosquitoes that were trapped were caught in the control trap (χ^2 , $P < 0.001$ (testing against a null hypothesis of a 1:1 ratio in the traps), zoophilic index between 0.12 and 0.16) (see table 5.3; see also figs. 3.1.3, experiment IV & 4.2, experiment III for comparison). In study 1, a higher proportion of hybrids and progeny from the 1st backcross to *An. gambiae s.s.* were observed to enter the cow odour port, although the zoophilic index of both hybrids and progeny of the 1st backcross to *An. gambiae s.s.* was not significantly different from pure *An. gambiae s.s.* (see figure 5.11(a)). However, the proportion of mosquitoes from the first backcross to *An. quadriannulatus* entering the cow odour port was significantly higher than for the other mosquitoes tested, i.e. the zoophilic index was significantly higher than for pure *An. gambiae s.s.*. In study 1, backcrosses to *An. gambiae s.s.* did not differ significantly in zoophilic index from backcrosses to *An. quadriannulatus*.

In study 2, there was no significant difference in the behaviour of mosquitoes from the parent *An. gambiae s.s.* strain and any of the three backcrosses to *An. gambiae s.s.*. The majority of mosquitoes entered the control port and not the cow odour port. The zoophilic index was similar to that observed in study 1 (i.e. less than 0.3). Pure *An. quadriannulatus* showed a very low overall response; only 17 responded out of 268 tested (6%) (see table 5.3) and among these the zoophilic index was significantly higher (0.59) than for all other mosquito crosses/ species tested (see figure 5.11 (a & b)). The overall response of mosquitoes backcrossed to *An. quadriannulatus* was consistently much higher than the overall response of pure *An. quadriannulatus* (35-46% vs. 6%). Surprisingly, the backcrosses to *An. quadriannulatus* showed similar behaviour to pure *An. gambiae s.s.* and backcrosses to *An. gambiae s.s.*; significantly more mosquitoes entered the control port than the cow odour port. The observed zoophilic index in the 3rd backcross to *An. quadriannulatus* was slightly higher (approaching 0.4) than in the 1st and 2nd backcrosses to *An. quadriannulatus* (around 0.3), although this difference was not significant.

Table 5.3. Results from behavioural experiments with hybrids and mosquitoes backcrossed to *An. gambiae* s.s. and *An. quadriannulatus*. See section 5.2.5 for definition of zoophilic index. The χ^2 test was used to check deviations from a random 1:1 ratio of mosquitoes entering either test port; N.S. = $P > 0.05$; ** $P < 0.01$; *** $P < 0.001$. F₁ hybrids were not tested in study 2.

STUDY 1						
Species/ mating	Proportion responding	Zoophilic index among responders	Null hypothesis that zoophilic index = 0.5	Number of experiments		
<i>An. gambiae</i> s.s.	110/231 (48%)	0.12	***	8		
<i>gambiae</i> x <i>quadriannulatus</i>	121/166 (73%)	0.33	***	6		
1 st backcross to <i>gambiae</i>	287/363 (79%)	0.28	***	10		
1 st backcross to <i>quadriannulatus</i>	147/412 (36%)	0.43	**	13		
STUDY 2						
Species/ mating	Proportion responding	Zoophilic index among responders	Null hypothesis that zoophilic index = 0.5	Number of experiments		
<i>An. gambiae</i> s.s.	103/401 (26%)	0.16	***	14		
1 st backcross to <i>gambiae</i>	280/575 (49%)	0.20	***	13		
2 nd backcross to <i>gambiae</i>	286/532 (54%)	0.19	***	12		
3 rd backcross to <i>gambiae</i>	187/310 (60%)	0.28	***	8		
<i>An. quadriannulatus</i>	17/268 (6%)	0.59	N.S	10		
1 st backcross to <i>quadriannulatus</i>	235/669 (35%)	0.27	***	16		
2 nd backcross to <i>quadriannulatus</i>	201/572 (35%)	0.24	***	14		
3 rd backcross to <i>quadriannulatus</i>	160/350 (46%)	0.36	***	10		

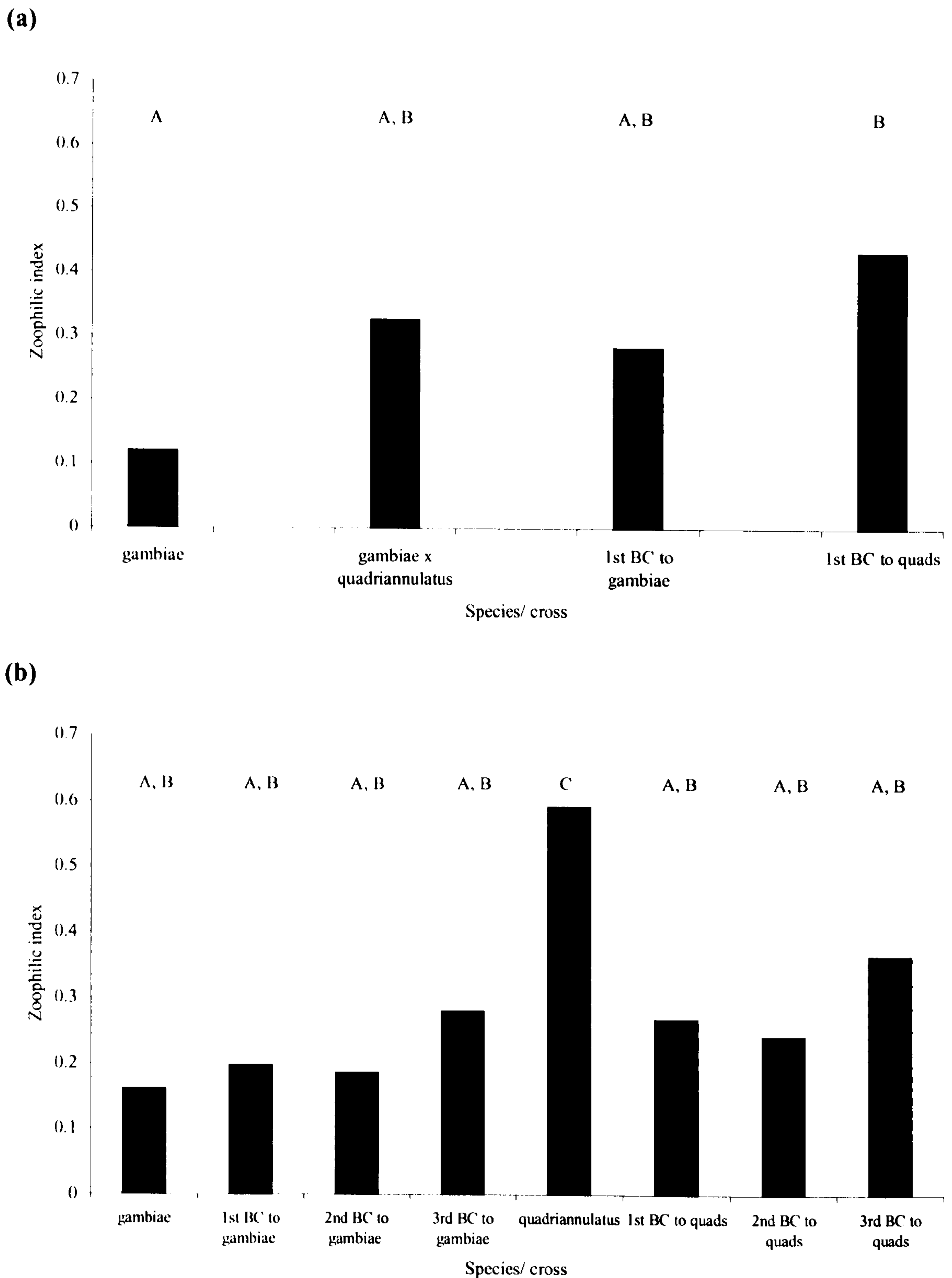

Figure 5.11. Zoophilic index for *An. gambiae s.s.*, *An. quadriannulatus*, hybrids and mosquitoes backcrossed to both parents in (a) study 1 and (b) study 2. Different letters indicate mosquito species/ crosses with a significantly different zoophilic index (extending across both studies). Zoophilic index >0.5 = preference for cow odour, <0.5 = aversion to cow odour. BC = backcross.

5.4 Discussion

Male hybrids from the cross between *An. gambiae s.s.* females and *An. quadriannulatus* males were completely sterile, as expected (Davidson, 1964a, b). The exact cause of sterility in male hybrids resulting from crosses between members of the *An. gambiae* complex is not known, although Curtis (1982) provided evidence that a cytoplasmic factor initiated by the maternal chromosome genome, in addition to the interaction of the 'mis-matched' X–Y chromosomes in the males' genome, caused the sterility. This hypothesis was reached after extensive crossing and backcrossing experiments using an *Anopheles gambiae* strain with the recessive X-linked marker 'white-eye' from Nigeria crossed with either *An. arabiensis* (normal, black-eyed strains from Sudan and Nigeria) or *An. quadriannulatus* (black-eyed strain from Chiredzi, Zimbabwe). In sibling-species hybrid females there is no recombination between the two X chromosomes, therefore it is possible to follow the whole of the X chromosome through interspecies crosses and backcrosses using a marker such as 'white-eye' (Curtis & Chalkley, 1979). Curtis (1982) observed that males from backcrosses to each parent (from an original cross between *An. gambiae s.s.* and *An. arabiensis*) yielded almost complete sterility when the X chromosome did not 'match' the Y chromosome and the majority of autosomal genes (see figure 5.10). When there was a 'match', approximately 40% of backcross males had sperm in their testes; a similar pattern was observed in progenies from the 2nd and 3rd backcrosses. Crosses and backcrosses between *An. gambiae s.s.* and *An. quadriannulatus* yielded simpler results since 'matched' X-Y chromosome individuals were completely fertile and 'mis-matched' individuals were completely sterile. This contrasts with results presented in section 5.3, where male backcross progeny were found for the most part, to be fertile. Hybrid females from an original cross between *An. quadriannulatus* species A with *An. quadriannulatus* species B that were backcrossed with *An. quadriannulatus* species A males resulted in male progeny that appeared to be fertile, with normal testes and accessory glands (Hunt *et al.*, 1998). In the present study, sixteen fertile males were observed in a small number dissected (only 20), which differed significantly from the 50% expected on the X/Y matched/ mismatched model. The difference in results from these two studies may be due to strain differences. Davidson (1964b) found that males from an *An. gambiae s.s.* strain from Kisumu mated with female *An. quadriannulatus* from Uzumba, Zimbabwe produced a near-normal sex ratio (57% hybrid males) with fertile F₂ offspring whereas all other males from strains of *An. gambiae s.s.* tested from Zimbabwe, Nigeria and Ivory Coast resulted in a male biased sex ratio. Furthermore, crosses between *An. arabiensis* males

(from Nigeria) with *An. melas* females (from Liberia) resulted in the proportion of females in the hybrid generation fluctuating from 'a very low level to as much as 25%' (Davidson *et al.*, 1970). Davidson (1964a) remarked that normal sex ratios, instead of the predominance of males, resulting from some crosses between *An. gambiae s.s.* or *An. arabiensis* males and *An. melas* or *An. merus* females indicated that within strains certain individuals are exceptionally compatible with members of a given strain and there may be some preferential mating of these more compatible individuals in a 'mass cage cross'. It is also possible that variation in the results from the crosses in the examples above were due to contamination of some of the laboratory colonies. Della Torre *et al.* (1997) performed backcrossing experiments between *An. gambiae s.s.* (SUA strain) and different strains of *An. arabiensis* and found that when the hybrid females were backcrossed with the same species/ strain that was used in the original cross, resulting backcross males were 100% fertile, whereas hybrid females backcrossed to males that were different to those used in the original cross resulted in backcross males that were 100% sterile. The main aim of this study was to investigate the behaviour of backcrossed females hence there was insufficient time to devote to a full study of inter-species crossing sterility.

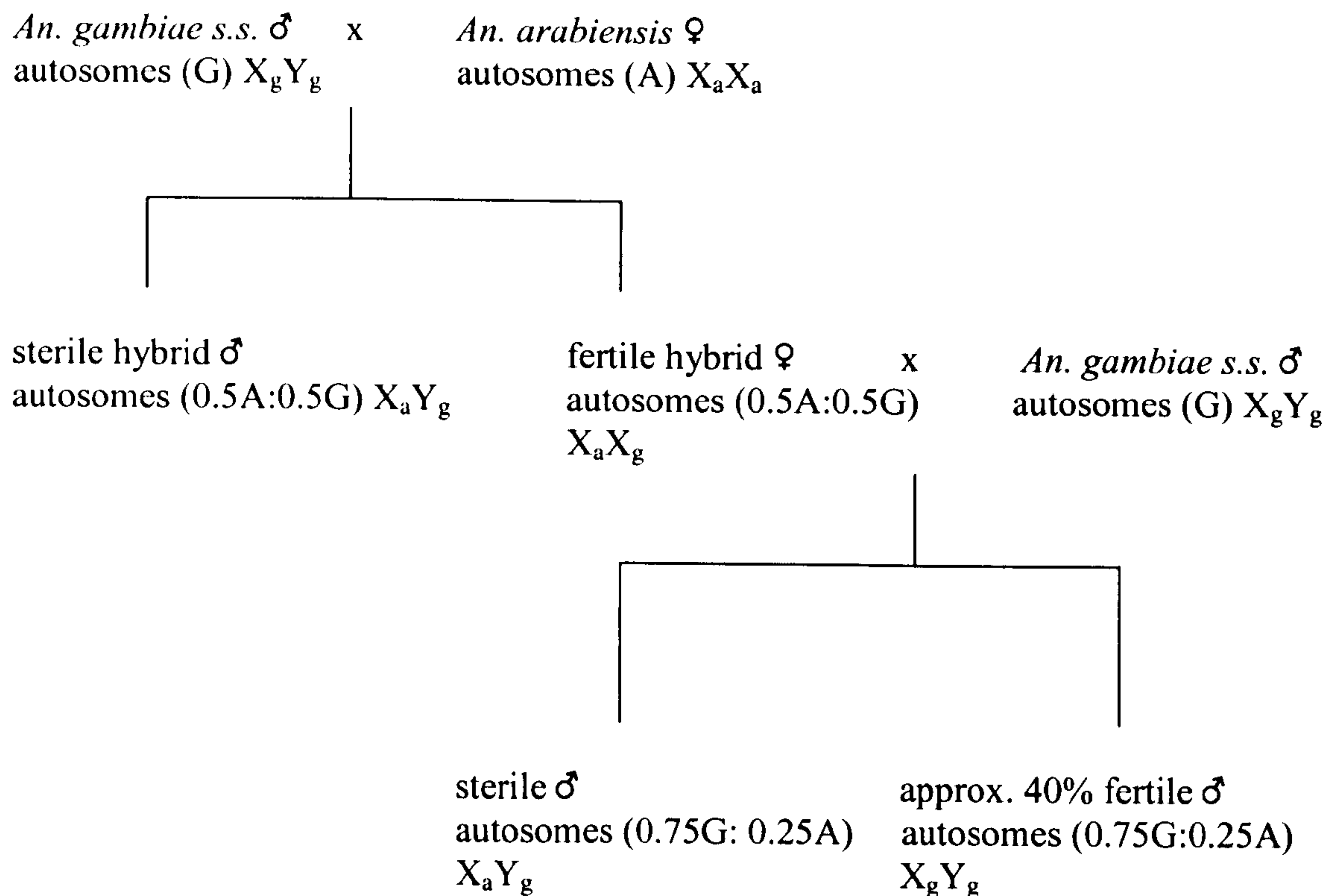

Figure 5.12. Degree of sterility in males resulting from *An. gambiae s.s.* x *An. arabiensis* hybrid females backcrossed to *An. gambiae s.s.* males (from Curtis, 1982). G = autosomes of *gambiae* origin, A = autosomes of *arabiensis* origin.

The bioassay using cow odour + carbon dioxide tested against a control in the olfactometer revealed the main differences in the host preference expected between *An. gambiae s.s.* and *An. quadriannulatus*; *An. gambiae s.s.* had a zoophilic index of only between 0.1 and 0.2, whereas *An. quadriannulatus* had a significantly higher zoophilic index of 0.6. This agrees very closely with experiments in section 4.2, where the zoophilic index of *An. gambiae s.s.* was 0.1 and the zoophilic index of *An. quadriannulatus* was 0.6.

In study 1, there was no significant difference between the zoophilic index of *An. gambiae s.s.*, hybrids, and mosquitoes resulting from the first backcross to *An. gambiae s.s.*. Only the zoophilic index of mosquitoes resulting from the first backcross to *An. quadriannulatus* was significantly higher than that of *An. gambiae s.s.* tested in that study (this study did not include *An. quadriannulatus*). This contrasts with results from study 2, where there was no significant difference between the zoophilic index of any of the mosquitoes tested, with the exception of *An. quadriannulatus*. These

differences probably arose because in study 1 zoophilic F₁ hybrids with zoophilic tendencies were selected to make the first backcross, whereas in study 2 there was no selection within the F₁ hybrids used in the first backcross. This seems to indicate that there is genetic variability, between individuals within the pure species, for genes involved in host preference.

These results indicate that anthropophilic behaviour in *An. gambiae s.s.* is a dominant or partially dominant trait. It was not possible to significantly change the zoophilic index of *An. gambiae s.s.* by crossing in genes from *An. quadriannulatus*. This was not surprising since the results from chapter 3 and 4 demonstrated that *An. quadriannulatus* accepts both cows and humans as hosts. Furthermore, the zoophilic index of mosquitoes from all three backcrosses to *An. quadriannulatus* was not significantly different from that of *An. gambiae s.s.* or any of the backcrosses to *An. gambiae s.s.*. It is expected that after three backcrosses $15/16$ of the genes would have derived from *An. quadriannulatus*. Thus, the effect of a small proportion of genes from *An. gambiae s.s.* seems to have a predominant effect on the host preference of the progeny.

It seems possible that exophilic and endophilic behavioural tendencies are expressed in the form of the total number of mosquitoes responding in the olfactometer (for example, the more mosquitoes responding, the more endophilic the mosquito is), but cytotaxonomical studies could reveal inversion polymorphisms that may help to explain why the response of *An. quadriannulatus* in the olfactometer was always so low. Coluzzi *et al.* (1977) found a relationship between the 2R inversion polymorphism and differential endophily and endophagy in *An. arabiensis* from Nigeria; mosquitoes with the 2R+a and 2Rbc arrangements were found more frequently in outdoor collections from donkeys, outdoor collections on men and exit trap catches than in the corresponding collections from men indoors and/ or indoor resting catches. In the Kisumu area of Kenya, Petrarca and Beier (1992) found a significant non-uniform distribution of human- and bovid-fed specimens detected among the carriers of different 2Rb inversion karyotypes in indoor resting *An. arabiensis*. Studies on *An. arabiensis* from different localities in the Awash valley, Ethiopia have also shown that the frequency of specimens carrying the 2Rb arrangement increases with altitude (Mekuria *et al.*, 1982) which corresponds with observations by White (1974) that the lack of 2Ra and 2Rc configurations in chromosomes of *An. arabiensis* from the highlands of Ethiopia is accompanied by complete female endophily. *Anopheles quadriannulatus* in Ethiopia also tends to be endophilic where it occurs at high altitudes (White, 1974a). Studies in Nigeria and

Ethiopia established that carriers of the standard 2Ra homozygote or the 2Rc heterozygote arrangement tend to be the most exophilic and exophagic specimens (White, 1974b). Significant differences between indoor and outdoor collected samples of *An. arabiensis* with respect to inversion 3Ra have also been found in the Baringo district of Kenya (Mnzava *et al.*, 1994). The exophilic habits of members of the *An. coustani* group are well known and experiments in The Gambia have shown that a tendency for *An. ziemani* to avoid houses was linked with the reluctance to penetrate through small apertures to reach the host (Gillies & Coetzee, 1987).

Molecular studies using classified material from these olfactometer studies should reveal the main genetic differences between *An. gambiae s.s.* and *An. quadriannulatus* and would perhaps provide information regarding the position and genetic structure of the behavioural genes within the genome. This may then help to explain the dominance of anthropophily and the influence these genes have over genes controlling zoophilic behaviour. Fox *et al.* (2001) have found that the molecular pathways involved in host odour perception are completely conserved between species. Moreover, genes involved in odour reception are clustered on the genome of *An. gambiae s.s.*. One such gene, AgOR1 is female specific and detectable (i.e. 'switched on') prior to a bloodmeal but not detectable after a bloodmeal; expression returns approximately 72 hours after feeding. Takken *et al.* (2001) found that host-seeking was suppressed immediately after a blood meal and remained suppressed for up to 48 hours after feeding. The host-response returned to normal levels 72 hours after feeding, even in females that had not yet oviposited, which suggests this gene may also be involved in oviposition cues.

The results from the behavioural studies discussed here and those in sections 3.2, 3.3, 3.4 and 4.2 indicate that zoophilic behaviour may be highly plastic. *Anopheles quadriannulatus* appeared to prefer human odour to cattle odour (unless cattle odour was tested against a control) at least under laboratory conditions and considering these earlier observations, the results from the crossing studies are perhaps not so surprising. Furthermore, it may be argued that the reciprocal cross to the one performed at the origin of the crossing studies (i.e. *An. gambiae s.s.* males crossed with *An. quadriannulatus* females) may have produced very different results. Mukwaya (1977) studied the genetic basis of animal and man-biting behaviour in *Aedes* mosquitoes and concluded that the genes concerned were sex-linked, in which case reciprocal crosses would not produce a different result because females receive an X chromosome from each parent.

The plasticity of zoophily coupled with the dominance of the anthropophilic trait poses a serious and unexpected obstacle for studies designed to investigate the transfer of genes by backcrossing. This will be discussed further in chapter 8. It has been argued that backcrossing experiments using *An. gambiae s.s.* and *An. quadriannulatus* have the disadvantage of ‘hitch-hiking’ other genes that might lead to undesirable epistatic and pleiotropic effects and therefore use of more closely related taxa such as *An. arabiensis* from Madagascar and West Africa or the uniquely zoophilic *An. gambiae s.s.* from Fenoarivo (Madagascar), may provide better options (Costantini *et al.*, 1999; Duchemin *et al.*, 2001). Such undesirable effects may include reduced fitness. The importance of mosquito fitness was highlighted in a model by Kiszewski and Spielman (1998) who showed that the success of a transgenic release required transposon-bearers to be nearly as fit as the wild mosquitoes that they were to displace and that fixation may require 150 or more generations. Catteruccia *et al.* (2000) developed a genetic transformation system for *Anopheles stephensi* using a green fluorescent protein from a jellyfish and performed fitness experiments with transformed mosquitoes. Transgenic lines were found to be less fit and less competitive than wild-type lines. The very existence of isolated populations of zoophilic *An. gambiae s.s.* or *An. arabiensis* (Ralisoa Randrianasolo & Coluzzi, 1987; Diatta *et al.*, 1998; Duchemin *et al.*, 2001) illustrates that there is variability in the degree of anthropophily within one species. Whether this variability is of genetic origin or due to insecticidal pressure, host availability or other environmental conditions (such as climate) remains to be established. However, evidence for stable zoophilic behaviour in any member of the *An. gambiae* complex is needed before meaningful backcrossing studies could proceed.

Chapter 6

FIELD STUDIES ON *ANOPHELES QUADRIANNULATUS* SPECIES B

6.1 General Introduction

Davidson *et al.* (1967) found that *An. quadriannulatus* from Ethiopia gave the same results in cross-mating studies with other members of the *An. gambiae* complex as *An. quadriannulatus* from South Africa and assumed they were conspecific. However, the annual reports of Davidson to the WHO show that he did not cross South African and Ethiopian material. Hunt *et al.* (1998) found sterile hybrid males and asynapsis of the polytene chromosomes of female hybrids (though they were apparently homosequential) when South African *An. quadriannulatus* specimens were crossed with Ethiopian *An. quadriannulatus*. Hunt *et al.* (1998) renamed the Ethiopian taxon *An. quadriannulatus* species B, and *An. quadriannulatus* from South Africa was renamed *An. quadriannulatus* species A. The PCR identification system of Scott *et al.* (1993) can distinguish both forms of *An. quadriannulatus* from other members of the *An. gambiae* complex but not from each other.

Relatively little is known about the behaviour of *Anopheles quadriannulatus* species B although mosquitoes probably belonging to this species were described by Turner (1972) who unfortunately does not mention the origin of the bloodmeals collected from the specimens. White (1974a) states that though they are predominantly zoophilic they "...willingly bite man, indoors or outdoors, especially when located confusingly close to cattle". *Anopheles quadriannulatus* species B, like A, appears to be practically absent from houses occupied by humans only and more frequent in houses occupied by humans and cattle and in buildings with cattle only (White, 1974a, White *et al.*, 1980; Hunt *et al.*, 1998). The human blood index and sporozoite rate (calculated from resting catches) were less than 1% (White *et al.*, 1980) and zero respectively (White *et al.*, 1980; Hunt *et al.*, 1998) and reflect the highly zoophilic behaviour of this species. The differential degree of endophily (indoor resting) in *An. quadriannulatus* species B appears to be related to the altitude, i.e. in cool higher altitudes the mosquitoes tend to be endophilic.

Following the unexpected results discussed in chapters 3 and 5, it was hoped that *An. quadriannulatus* species B might be a better source of zoophilic genes than *An. quadriannulatus* species A. Therefore, a field study was undertaken to study host choice and sporozoite rates and to collect eggs from *An. quadriannulatus* species B to

attempt to establish a colony that could be used for further behavioural studies in the laboratory.

6.2 Description of study area

Ethiopia is a large country of 1.127 million square kilometres situated in North East Africa, 8° North and 38° East, with a population of over 65 million (see figure 6.1). Ethiopia is currently divided into 9 ethnically based states and two self-governing administrations, Addis Ababa and Dire Dawa. Most of the country is situated 1500m above sea level and temperatures depend on the altitude. There are three climatic zones in Ethiopia; a cool zone in central parts of the western and eastern sections of the central plateau, a temperate zone consisting of portions of the central plateau between 1500m to 2400m and a hot zone below 1500m. There are two main seasons, the dry season that generally runs from October through to May and the rainy season from June through to September. More than seventy languages are spoken in Ethiopia, although the official language is Amharic.

(all above details from: <http://www.odci.gov/cia/publications/factbook/geos/et.html>)

Ethiopia's economy is based on agriculture, which accounts for half of the Gross Domestic Product, 90% of exports and 80% of total employment; 89% of the population lives in rural areas (fig. 6.2A & B) (see reference to website above). The basis of rural life is a community consisting of a number of families residing in a cluster of *Tukuls* (fig. 6.2C). Villages are built on an extended family basis (*Sebekas*) and small rural villages are usually built on mountain plateaus (*Ambas*). The *Tukul* is a traditional Ethiopian house, which is circular with mud walls, a thatched roof, no windows and dual egress. A *Tukul* has only one room, if there is a second it is usually a partition for animals (*Gata*). The lifespan of a *Tukul* is about 10 years. Furnishings include a flat raised area to sit on and sleep, and a fireplace in the middle of the room to cook and heat the room (fig.6.2E). The occupants often live with cattle (and other animals e.g. goats) in the same room for warmth and/ or fear of thieves. Houses may also be made of straw and sticks or are rectangular structures with a corrugated sheet iron roof (Chand, 1965) (fig. 6.2D, F & G).

Malaria is unstable and prevalent in the lowlands and riverbasins whilst highland populations are exposed to frequent epidemic waves (Chand, 1965) (see risk map in fig. 6.1B). The malaria transmission season runs from July to December, peaking in October and November. The critical height up to which malaria occurs is around 2000m and epidemics are rainfall associated when suitable breeding sites are present or created. Periodic epidemics have been associated with increases in temperature, abnormally high

rainfall and the creation of favourable mosquito breeding sites in riverbeds, prolonged dry seasons and famine (Chand, 1965; Abose *et al.*, 1998). The most affected epidemic areas include the highlands and highland fringe areas where the population has no immunity due to the short transmission season and long interval with no infection. Recent epidemics have been caused by chloroquine resistant *Plasmodium falciparum*, large-scale population movement, expansion of developmental activities and war (Abose *et al.*, 1998). All four species of *Plasmodium* are present in Ethiopia, although *P. falciparum* and *P. vivax* are the most important (Krafsur, 1977; Abose *et al.*, 1998). *Anopheles arabiensis* is the main vector, and secondary vectors include *An. funestus*, *An. nili*, and *An. pharoensis* (Krafsur, 1977; Nigatu *et al.*, 1994; Abose *et al.*, 1998). *Anopheles arabiensis* is also a vector of filariasis in Gambella, Western Ethiopia, the only place in Ethiopia where filariasis is endemic (Hadis *et al.*, 1997). *Anopheles quadriannulatus* also exists in Ethiopia, although it has only been reported in the Jimma (Jima) region (White *et al.*, 1980; Hunt *et al.*, 1998) (see fig. 6.1A).



Figure 6.1 (A) Map of Ethiopia showing the main cities, towns and borders (©1994 Magellan Geographix™, Santa Barbara, CA, USA). The area of the study site is marked in blue.

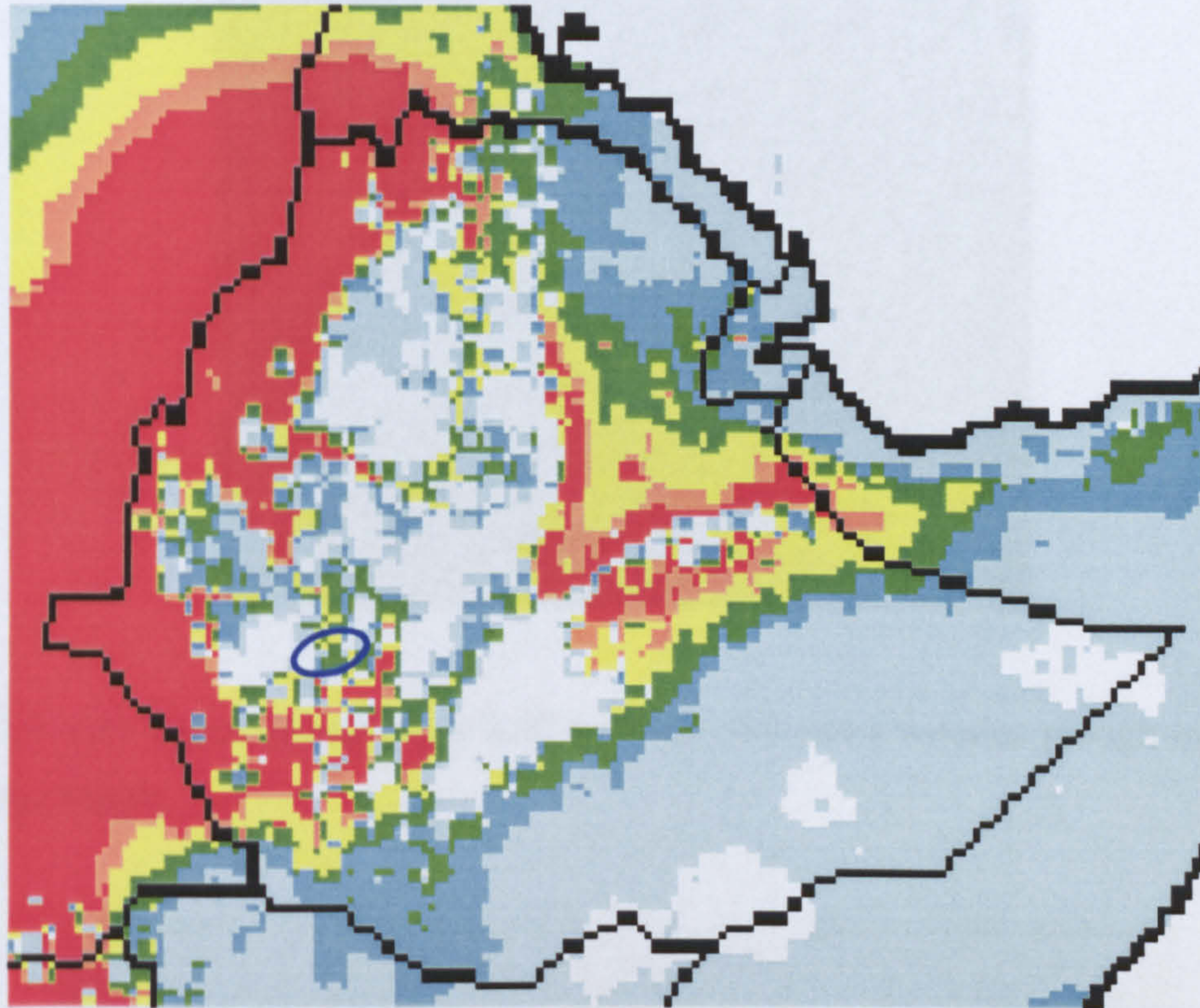
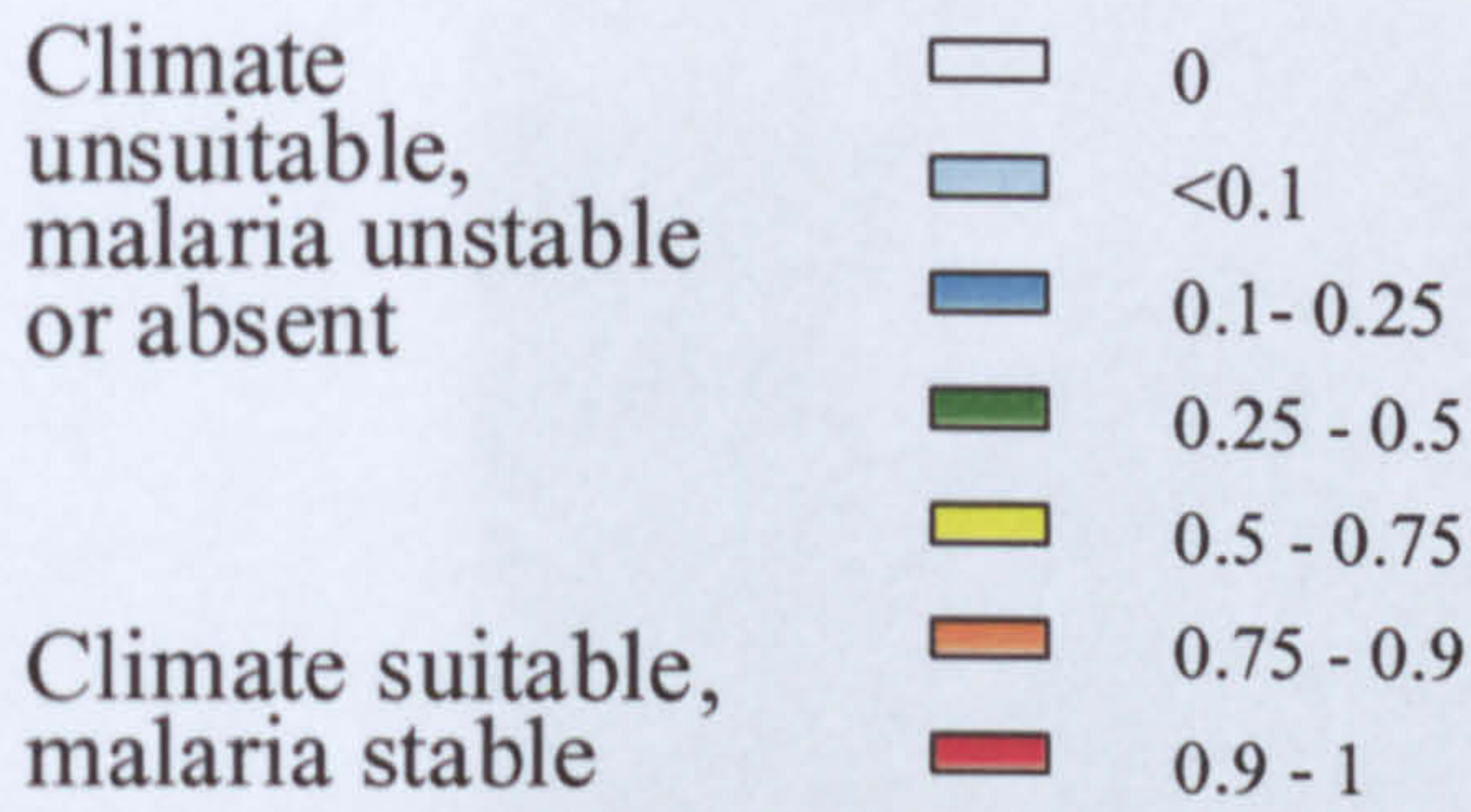

Figure 6.1 (B) Malaria risk map for Ethiopia (source: MARA/ AMRA: <http://www.mara.org.za/>). The map uses data from a theoretical model based on long-term climate data and shows the theoretical suitability of the local climate and therefore the potential distribution of stable malaria transmission in the average year. The study area, Jimma region, falls in an area that ranges all the way from 0 – 0.75 on the malaria risk map (indicated within the blue boundary).



Figure 6.2. (A) A typical field with some of its inhabitants.

Figure 6.2. (A) A man ploughing a field with his cow and a wooden plough in a field in the Jimma Valley.



Figure 6.2. (B) A rectangular house with mud walls and a corrugated iron roof with some

Figure 6.2. (B) View of Serbo town, the nearest market town serving the villages of Babo, Minko and Abukako.



Figure 6.2. (C) A typical *Tukul* with some of its inhabitants.



Figure 6.2. (D) A rectangular house with mud walls and a corrugated iron roof with some of its inhabitants.



Figure 6.2. (E) The cooking area inside a *Tukul*. The fire is lit in the middle of the room and *injera* (the traditional food) can be cooked directly over the fire.



Figure 6.2. (F) A window in a rectangular house with mud walls. Very large gaps facilitating mosquito entry are visible between the window frame and wall.



Figure 6.2. (G) Corrugated iron roofing on the rectangular house shown in (6.2. D), a large gap between the top of the wall and iron roof is visible.

6.3 Materials & methods

6.3.1 Design of the field study

Mosquito collections were carried out in the villages of Babo and Abukako (1800m altitude) in the Jimma Valley ($7^{\circ}39' N$, $36^{\circ}47' E$, 335km South West of Addis Ababa) in July and August of 2000. These villages were chosen in view of the observations of Hunt *et al.* (1998), who performed an extensive survey of the area and only found *An. quadriannulatus* species B in the villages of Babo and nearby Minko, approximately 18km east of Jimma (see fig. 6.1A). Indoor resting catches were performed twice weekly over a period of 4 weeks in human-only habitations, houses occupied by humans and animals and cattle sheds using an aspirator, torch and paper collection cup, searching for 20 minutes per house between 0700 and 1030 hours. Mosquitoes from each location were kept in the paper cup until they could be identified and dried for storage. Blood-fed *An. gambiae s.l.* were set aside for egg-laying by placing single females in a plastic vial covered with mosquito netting, containing damp cotton wool overlaid with damp filter paper. One house occupied by humans only, one house shared by humans and

cattle and one cattle shed were chosen to set up CDC light traps⁹ (John W. Hock Company, Gainesville, FL, USA) and bednets (WRG, Grave, The Netherlands) to catch host-seeking mosquitoes during the night. These catching stations were chosen on the basis of willingness of occupants to participate, mosquito density (determined by previous resting catches), accessibility, the presence of a single sleeping area for all household members and the number of animals present. Bednets were hung so that all hosts slept underneath the net, and the CDC light trap was hung at the foot of the bed/ sleeping area, approximately 1m from the ground. The traps were set at 1800 and turned off at 0600 the following morning for 5 consecutive nights. Resting catches did not take place in the same rooms/ houses as the light trap catches.

Mosquitoes were identified using the key from Gillies & Coetzee (1987) and mosquitoes belonging to the *An. gambiae* complex stored in labelled eppendorf tubes with silica gel and cotton wool and were identified using the PCR identification system of Scott *et al.* (1993) (see section 2.6). Culicines were not identified to species level. A map of the study area and plan of the light trap catching stations are shown in figure 6.3. All mosquito specimens caught from both light traps and resting catches were tested for the presence of sporozoites using the ELISA method described below. Bloodfed mosquitoes from the resting catches were either dried in silica gel in an eppendorf or their bloodmeal squashed onto filter paper. Bloodmeals were then subjected to the precipitin test described in section 2.7.

⁹ The CDC light trap consists of a Plexiglas cylinder with slots on each side to receive a metal bracket. A motor and fan made from plastic or aluminium is fitted onto the spindle of the motor and a torch bulb mounted directly above the motor at the top of the trap body. The trap is run using a 6 V battery and a wire mesh screen placed over the entrance of the trap body serves to exclude large insects. A fine cloth mesh bag with a long narrow neck fitted to the end of the trap receives the catch and a large plastic or metal flat cover is placed over the trap to protect it from rain (this can be removed when used indoors). Correct placement of the trap is essential (taken from Service, 1993).

6.3.2 *Circumsporozoite Enzyme Linked Immunosorbent Assay (cs-ELISA): Identification of sporozoite positive mosquitoes (Wirtz et al., 1987)*

6.3.2.1 *Mosquito preparation*

The head and thorax were removed from each mosquito specimen and placed in an eppendorf with 50µl extraction buffer¹⁰. Mosquitoes were ground up using a pestle and 2 x 75µl PBS-Tween¹¹ added and used to rinse the pipette. After grinding, individual samples were pooled into groups of ten. Pools were tested and if a pool was positive, samples from that pool were retested individually. Samples were stored at -20°C until ready for use.

6.3.2.2 *Protocol*

Microtitre plates were coated with 50µl monoclonal antibody per well (falciparum = 0.10µg in 50µl PBS¹²; vivax (210) = 0.025µg in 50µl PBS; malariae = 0.25µg in 50µl PBS) and left covered, overnight. The plates were then emptied, coated with blocking buffer (200 µl per well) and left for 1 hour after which the plates were emptied, and the samples added, including positive and negative controls (blocking buffer¹³ was used for negative controls) (50 µl per well). The plates were then left covered for 2 hours, then emptied and washed thoroughly (5 times) with PBS-Tween. Peroxidase labelled antibody (50 µl per well) was added to the plates (falc = 20 µl stock/ 5 ml blocking buffer; viv = 50 µl stock/ 5 ml blocking buffer; mal = 50 µl stock/ 5 ml blocking buffer) and the plates were left covered for 1 hour. The plates were emptied and washed thoroughly (3 times) with PBS-Tween, ABTS¹⁴ (100 µl per well) was added and the plates left covered for 30 minutes. ELISA plates were read by eye, a dark green product indicating the presence of circumsporozoite protein after the enzyme reaction. The number of positive specimens was recorded by comparing with the positive controls on the plate. All materials were supplied by SmithKline Beecham and Sigma.

¹⁰ Extraction buffer = 5µl NP40 + 1ml blocking buffer (stored at 4°C)

¹¹ PBS-Tween (0.05%) = 0.5ml Tween 20 + 999.5ml PBS (stored at 4°C)

¹² PBS (Phosphate Buffer Saline) = 8g NaCl + 0.2g KCl + 1.44g Na₂HPO₄ + 0.24g KH₂PO₄ + 1000ml H₂O (adjusted to pH 7.4, autoclaved & stored at room temperature)

¹³ Blocking buffer = 5g Casein + 100ml NaOH (0.1M) (suspended & boiled) + 900ml PBS (added slowly & left to cool, pH adjusted to 7.4) + 0.2ml phenol red (dissolved & stored at 4°C or -20°C)

¹⁴ ABTS = ABTS tablets in solution + Hydrogen peroxide (mixed in 1:1 ratio immediately before use)

(A)

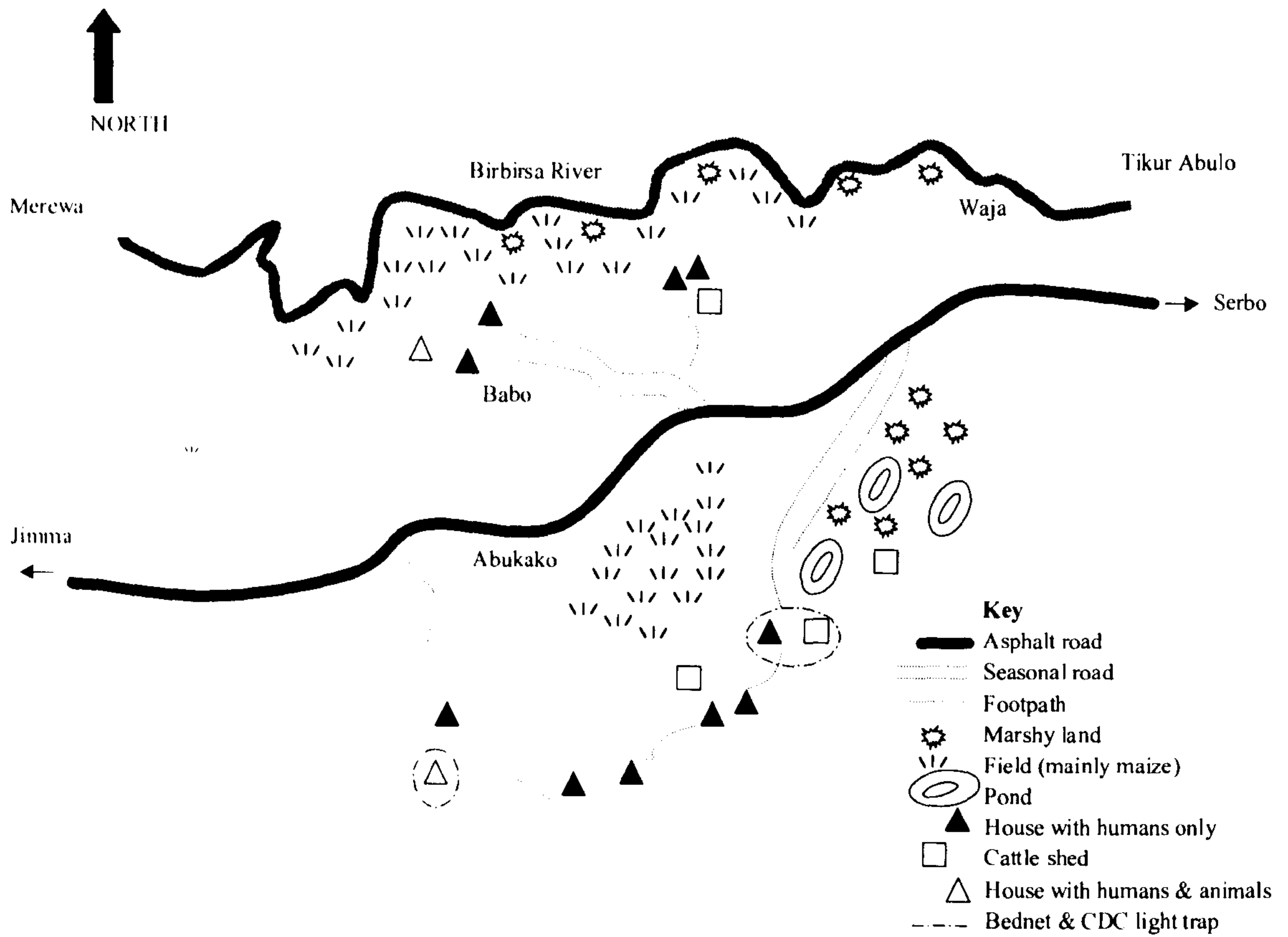

(B)

House occupied by humans only

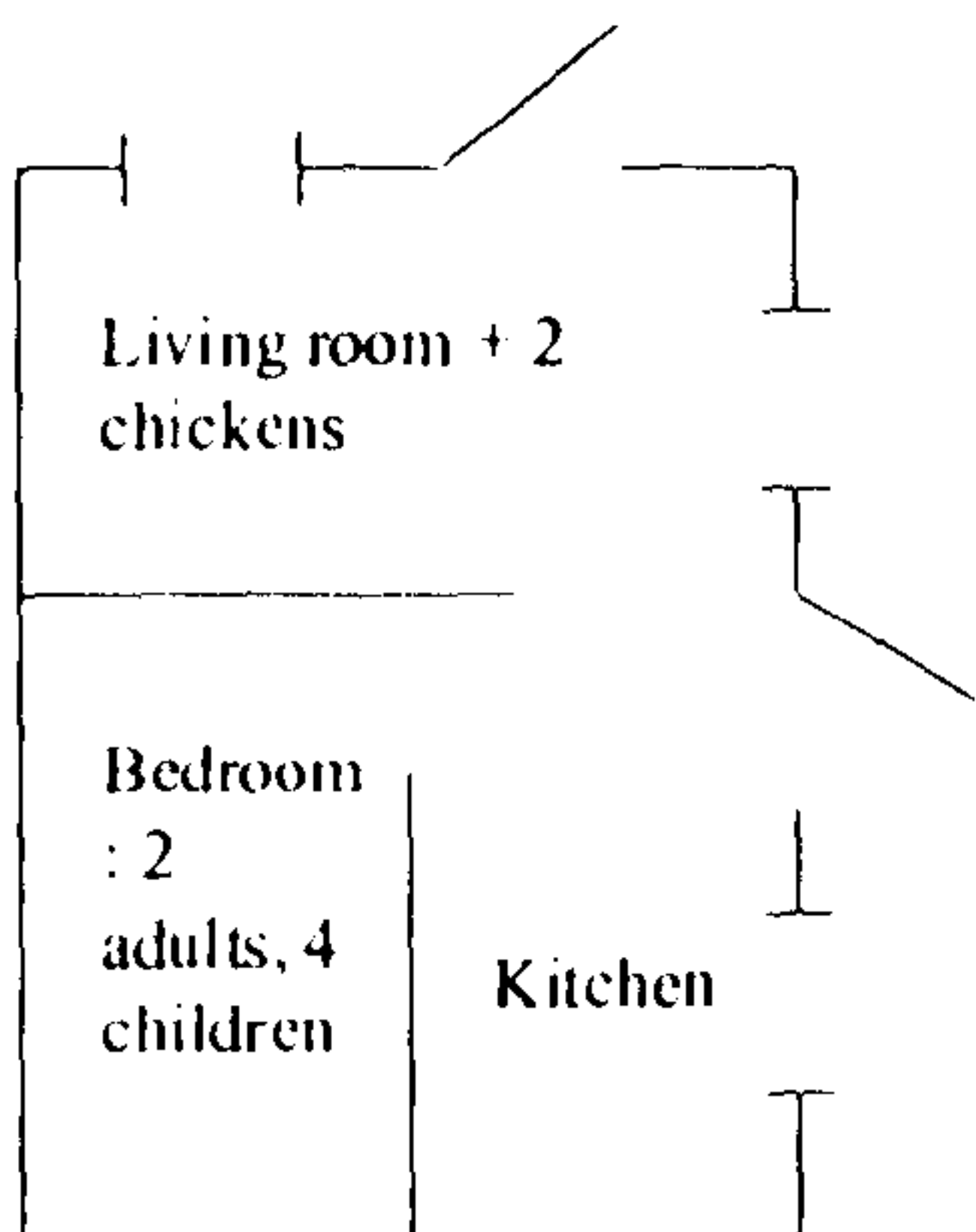

House occupied by humans and cattle

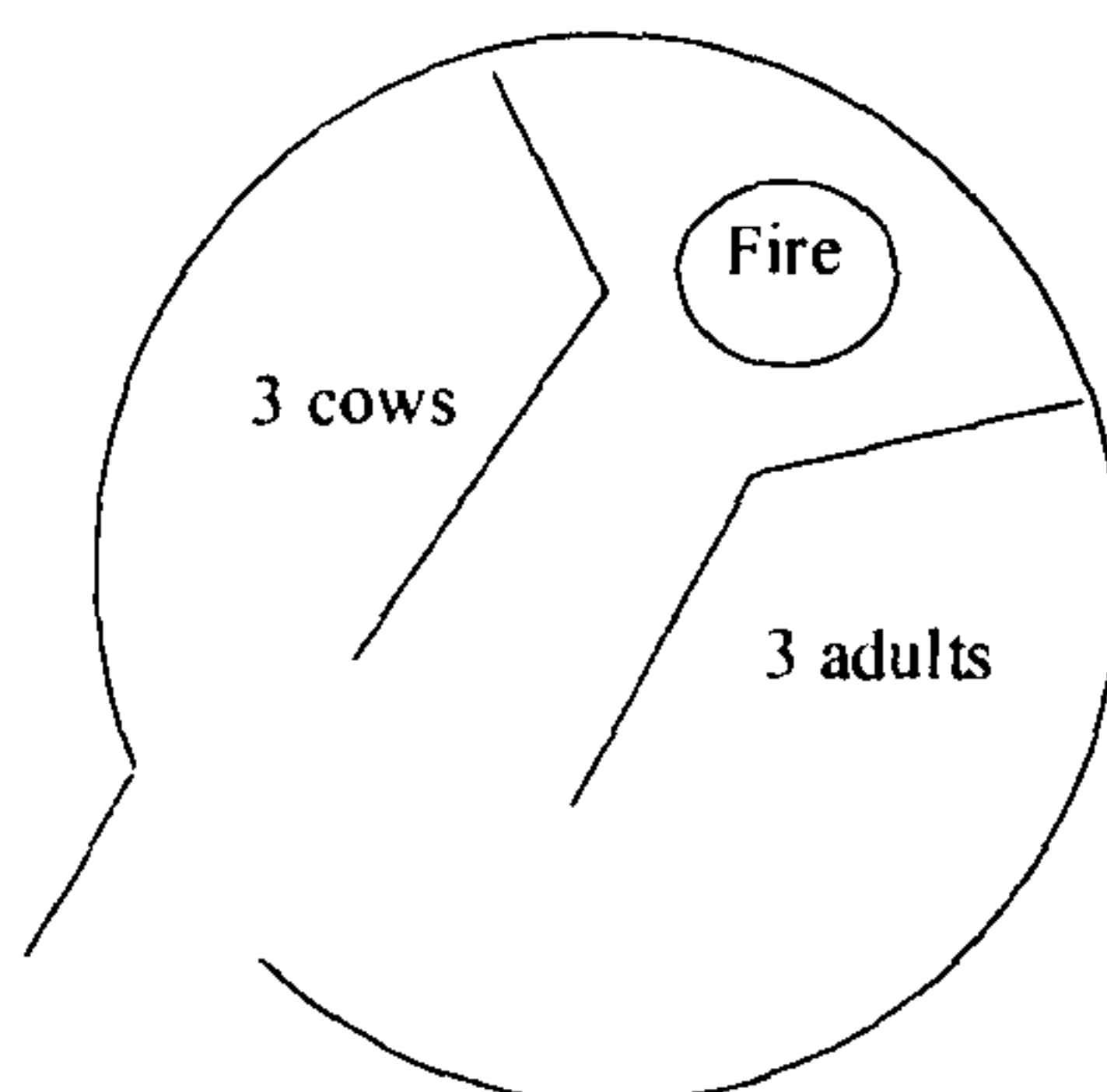

Cattle shed

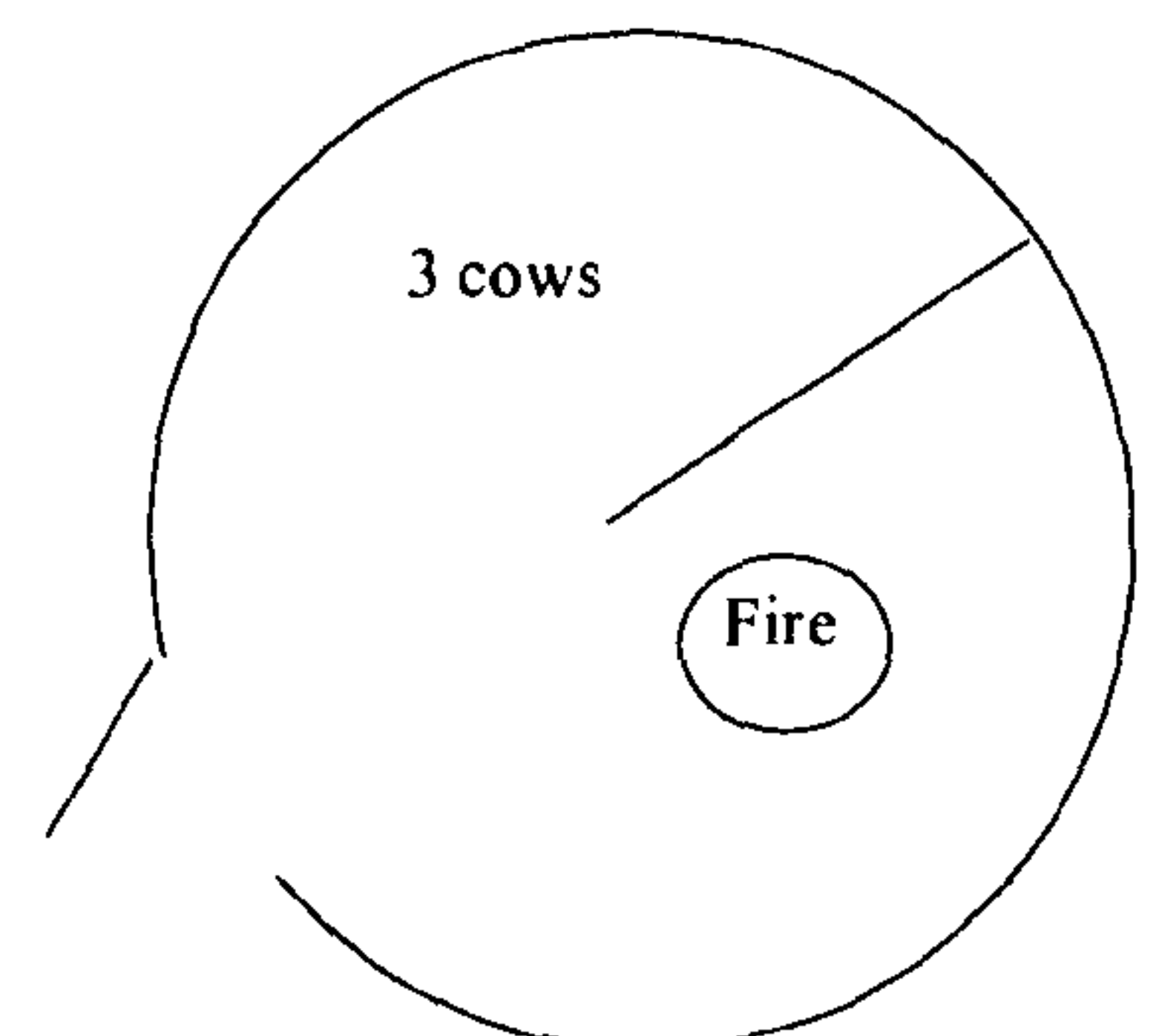

Figure 6.3. (A) Sketch map of the study site in the Jimma region of Ethiopia. (B) Ariel plan of light trap catching stations. The house occupied by humans only was rectangular (see figures 6.2D, F & G) with three windows and two doors, and the house occupied by humans and cattle and the cattle shed were *Tukuls* with only one door and no windows.

6.4 Results

A total of 3,433 mosquitoes were collected of which 2,910 were collected in light traps (83% *Anopheles*, 17% *Culex*, 98% unfed) and 523 in resting catches (94% *Anopheles*, 6% *Culex*, 82% fed). Six anopheline species were identified: *An. gambiae s.l.* (a mixture of *An. arabiensis* and *An. quadriannulatus*), *An. marshallii*, *An. demeilloni*, *An. coustani*, *An. chrystyi* and *An. cydippis*.

6.4.1 Composition of light trap catches

A total of 519 mosquitoes (mean = 103.8 per night) were caught in the light traps in the human house, 1295 mosquitoes (mean = 259 per night) in light traps in the house occupied by humans and cattle and 1096 (mean = 219.2 per night) in the cattle shed. The mean number of each mosquito species caught per night in the light traps is shown in figure 6.4 and details of the catch composition each night are given in table 6.1. Significantly more *Culex* were caught in the cow shed than in the human house. Approximately equal numbers of *An. gambiae s.l.* were caught in the human house and cattle shed. The largest number of *An. marshallii* and *An. demeilloni* were caught in the house occupied by humans and cattle and similar numbers of *An. coustani*, *An. chrystyi*, and *An. cydippis* were caught in the house occupied by humans and cattle and the cattle shed. Results from the PCR analysis of *An. gambiae s.l.* mosquitoes caught in the light traps are shown in fig.6.5 (see Appendix II for examples of gel photographs). *Anopheles quadriannulatus* and *An. arabiensis* were the only two members of the *An. gambiae* complex found in the collections. Nearly 70% of the *An. gambiae s.l.* caught in the cattle shed were identified as *An. quadriannulatus* whereas 35% of the *An. gambiae s.l.* mosquitoes caught in the human house were identified as *An. quadriannulatus*. Similar results were obtained for the human house and house occupied by humans and cattle in that the majority of the catch was composed of *An. arabiensis*. Fewer *An. arabiensis* were identified from traps in the cattle shed than in either of the other two catching stations. The presence of cattle in the house occupied by humans and cattle did not appear to increase the proportion of *An. quadriannulatus* caught in traps compared to the human house, as would have been expected.

Table 6.1. Composition of light trap catches over 5 nights in three catching stations.

Catching station	Number of <i>Culex spp.</i> caught per night						
	1	2	3	4	5	Total	Mean*
House occupied by humans only	30	35	6	4	7	82	16.4 ^a
House occupied by humans and cattle	51	24	27	32	25	159	31.8 ^{a,b}
Cattle shed	89	56	36	19	51	251	50.2 ^b
	Number of <i>An. gambiae s.l.</i> caught per night						
House occupied by humans only	90	70	40	60	52	312	62.4 ^a
House occupied by humans and cattle	19	30	30	26	71	176	35.2 ^a
Cattle shed	23	39	127	49	59	297	59.4 ^a
	Number of <i>An. marshallii</i> caught per night						
House occupied by humans only	5	6	2	3	0	16	3.2 ^a
House occupied by humans and cattle	83	54	128	34	250	549	109.8 ^b
Cattle shed	43	17	34	44	31	169	33.8 ^b
	Number of <i>An. demeilloni</i> caught per night						
House occupied by humans only	17	9	8	5	4	43	8.6 ^a
House occupied by humans and cattle	25	17	42	26	62	172	34.4 ^b
Cattle shed	30	11	21	17	16	95	19 ^b
	Number of <i>An. coustani</i> caught per night						
House occupied by humans only	20	13	0	3	0	36	7.2 ^a
House occupied by humans and cattle	12	8	14	19	26	79	15.8 ^a
Cattle shed	22	10	19	3	28	82	16.4 ^a
	Number of <i>An. chrystyi</i> caught per night						
House occupied by humans only	5	7	3	3	3	21	4.2 ^a
House occupied by humans and cattle	13	9	23	17	49	111	22.2 ^b
Cattle shed	38	41	30	12	30	151	30.2 ^b
	Number of <i>An. cydippis</i> caught per night						
House occupied by humans only	3	2	1	3	0	9	1.8 ^a
House occupied by humans and cattle	14	1	8	0	26	49	9.8 ^a
Cattle shed	5	0	13	13	20	51	10.2 ^a

*Different letters indicate significant differences between the mean number of each species caught in different catching stations (t-test, $P < 0.05$).

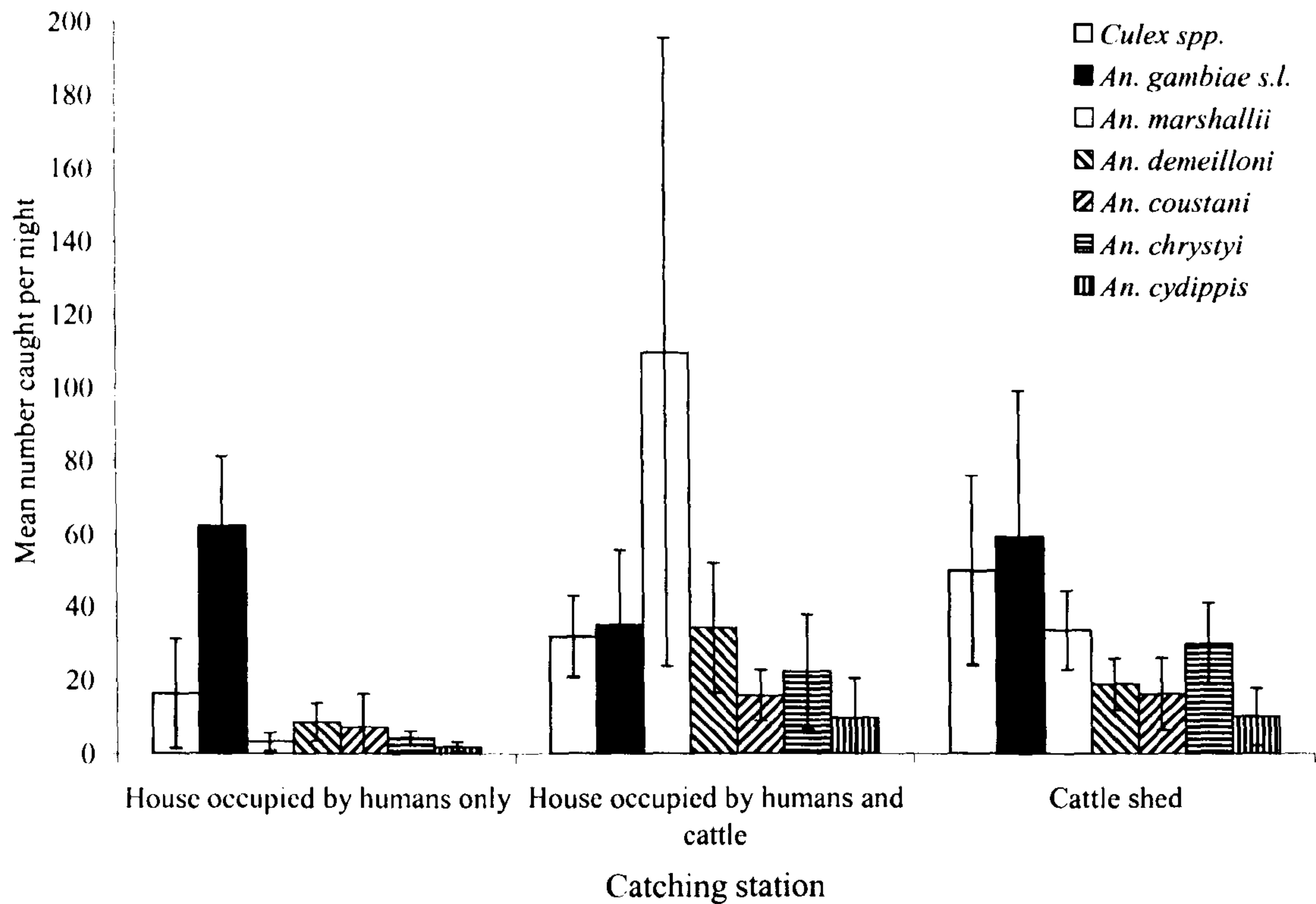

Figure 6.4. The morphological species composition of light traps in three types of housing after 5 nights of trapping. The graph shows the mean number of each species caught each night; see table 6.1 for significant differences between catching stations. Error bars indicate standard deviation.

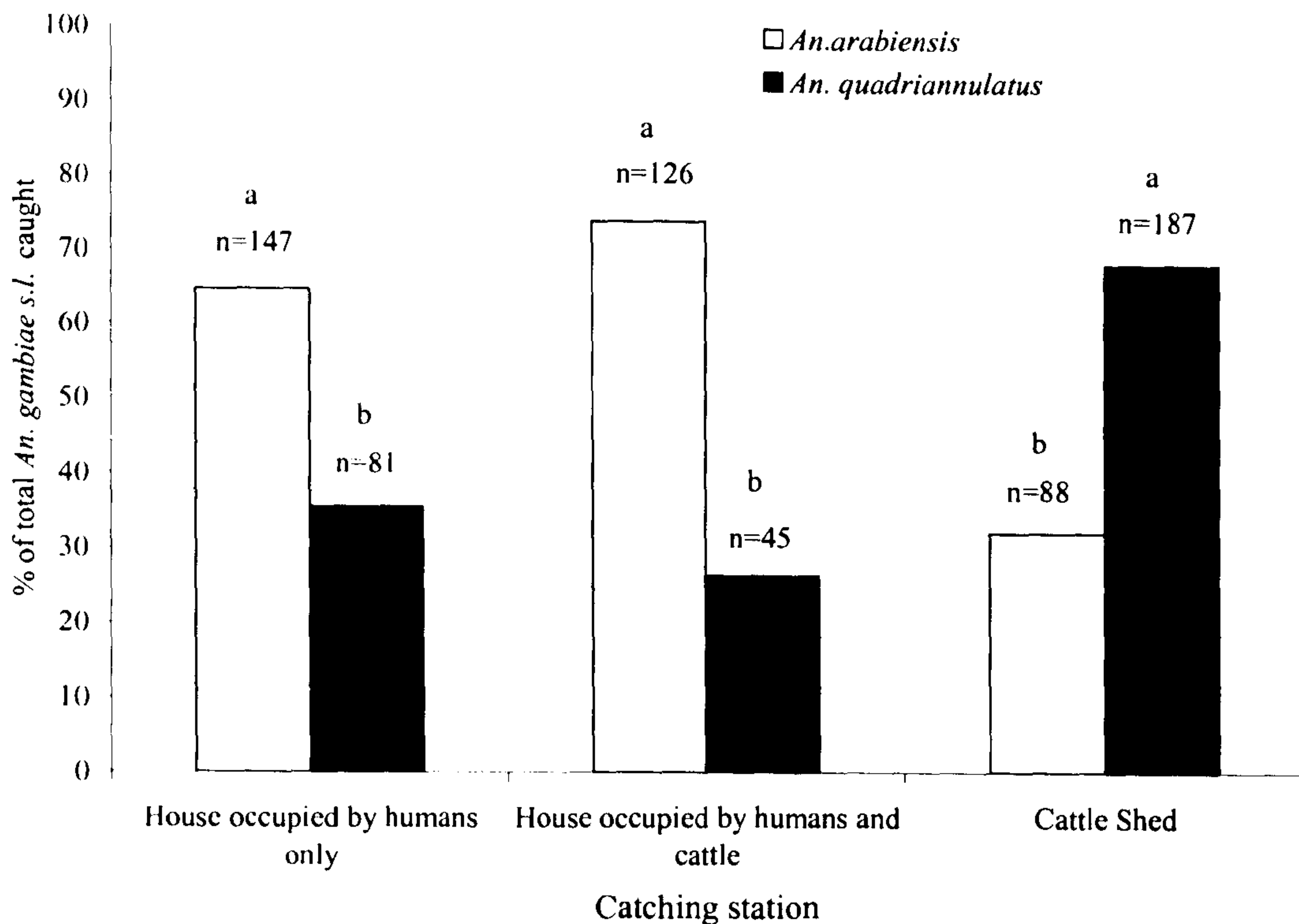

Figure 6.5. The composition of *An. gambiae s.l.* entering light traps in three housing types in 5 nights. n= total number of each sibling species identified from all catches. Approximately equal numbers of *An. gambiae s.l.* were caught in the house occupied by humans only and the cow shed whereas fewer *An. gambiae s.l.* were caught in the house occupied by humans and cattle (see n and fig. 6.4). Different letters indicate significant differences between the total number of each sibling species caught in the different catching stations (χ^2 distribution, $P < 0.05$).

6.4.2 Composition of resting catches

The species composition and distribution of the mosquitoes caught in resting catches at each site is shown in table 6.2 and figure 6.6. Virtually no *An. cydippis* or *An. coustani* were found in the resting catches, demonstrating the exophilic behaviour of these mosquitoes, which may not have been caught if the light trap catches had not taken place. There were proportionately more *An. gambiae s.l.* found resting in the human house, compared to the cattle shed (which was often a more open structure than the human houses). In total, 30% of the resting catch from human houses was identified as *An. gambiae s.l.* compared to 18% in cattle sheds. Very few mosquitoes were caught in resting catches in houses occupied by humans and animals, partly because the house found to contain the largest number of resting mosquitoes in the study area was used for light trap catches. Fewer resting catches were also performed in houses occupied by

humans and cattle due to problems of accessibility and absence of resting mosquitoes from such dwellings (see section 6.5). Probably because of degradation of specimens during storage, no DNA could be obtained from the *An. gambiae s.l.* specimen caught in the houses occupied by humans and animals. Therefore, figure 6.7 shows the results of the PCR analysis of *An. gambiae s.l.* caught in human houses and cattle sheds. The vast majority (93%) of the *An. gambiae s.l.* mosquitoes caught resting in the human houses were identified as *An. arabiensis*, whereas approximately half of the *An. gambiae s.l.* caught resting in cattle sheds were identified as *An. arabiensis*.

Thirty bloodfed female *An. gambiae s.l.* from cattle sheds were set up for egg laying in the field laboratory. Only six mosquitoes laid eggs after 48 hours; the remaining mosquitoes either died or digested their bloodmeal without laying eggs. The six *An. gambiae s.l.* females with their corresponding egg batches were sent to London; dried adults were identified using the PCR technique (Scott *et al.*, 1993) and the egg batches were reared separately. Of the six females, 5 were identified as *An. quadriannulatus* and 1 as *An. arabiensis*. Larvae from the five *An. quadriannulatus* females were mixed and the first generation of adults were obtained. However, the females from the F₁ generation would not feed (either from a membrane feeding system or from a human arm), therefore no F₂ generation was obtained.

Table 6.2. Species composition of resting catches.

Species	Houses occupied by humans only	Houses occupied by humans and animals	Cattle sheds	Total
<i>An. marshallii</i>	55	1	116	172
<i>An. chrystyi</i>	25	0	178	203
<i>An. demeilloni</i>	12	2	19	33
<i>An. cydippis</i>	1	0	3	4
<i>An. coustani</i>	1	0	0	1
<i>An. gambiae s.l.</i>	41	1	68	110
TOTAL	135	4	384	523

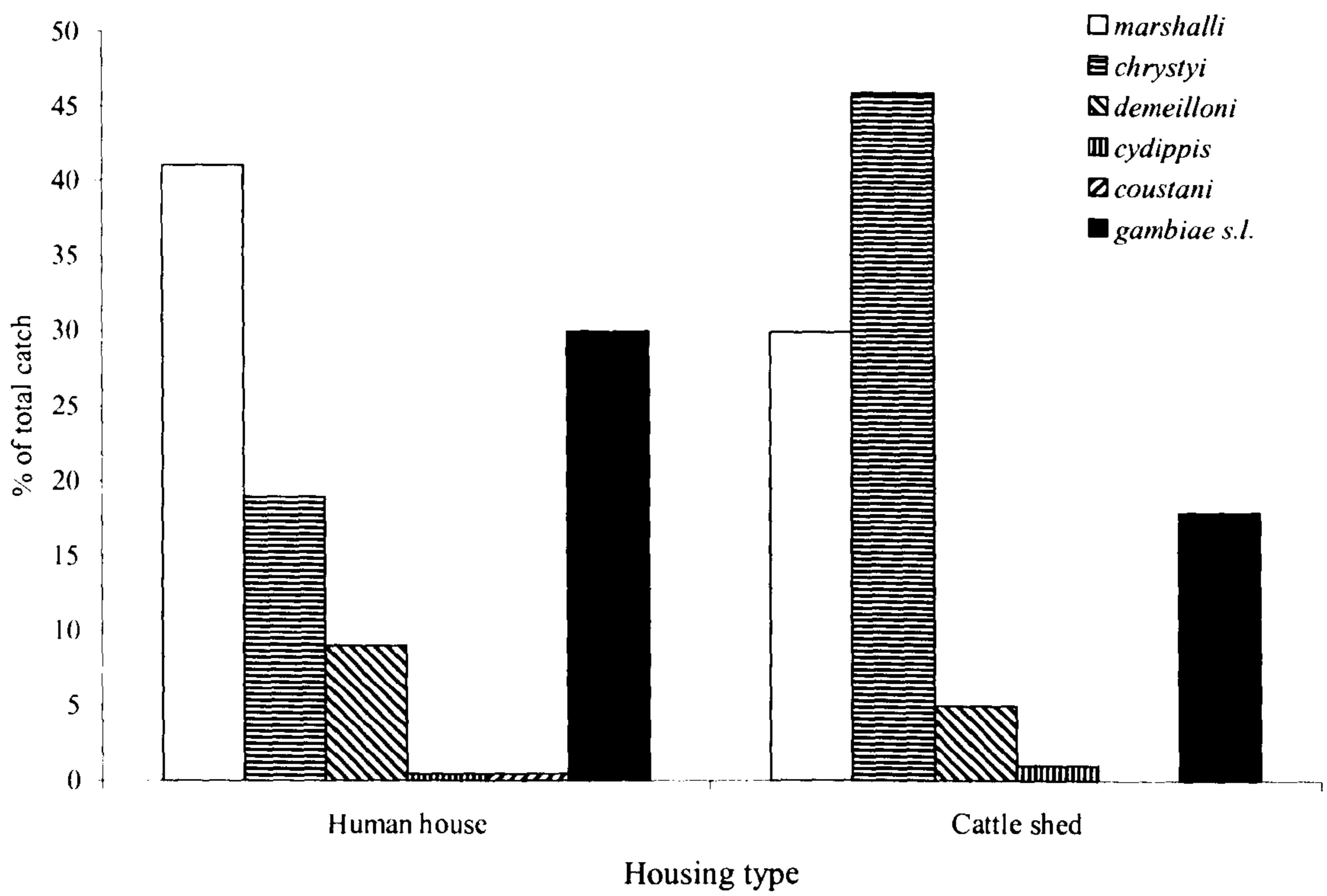

Figure 6.6. Distribution and species composition of mosquitoes caught in resting catches in two housing types in Babo and Abukako. Data for mosquitoes caught resting in houses occupied by humans and animals have not been included due to the small data set (see table 6.2).

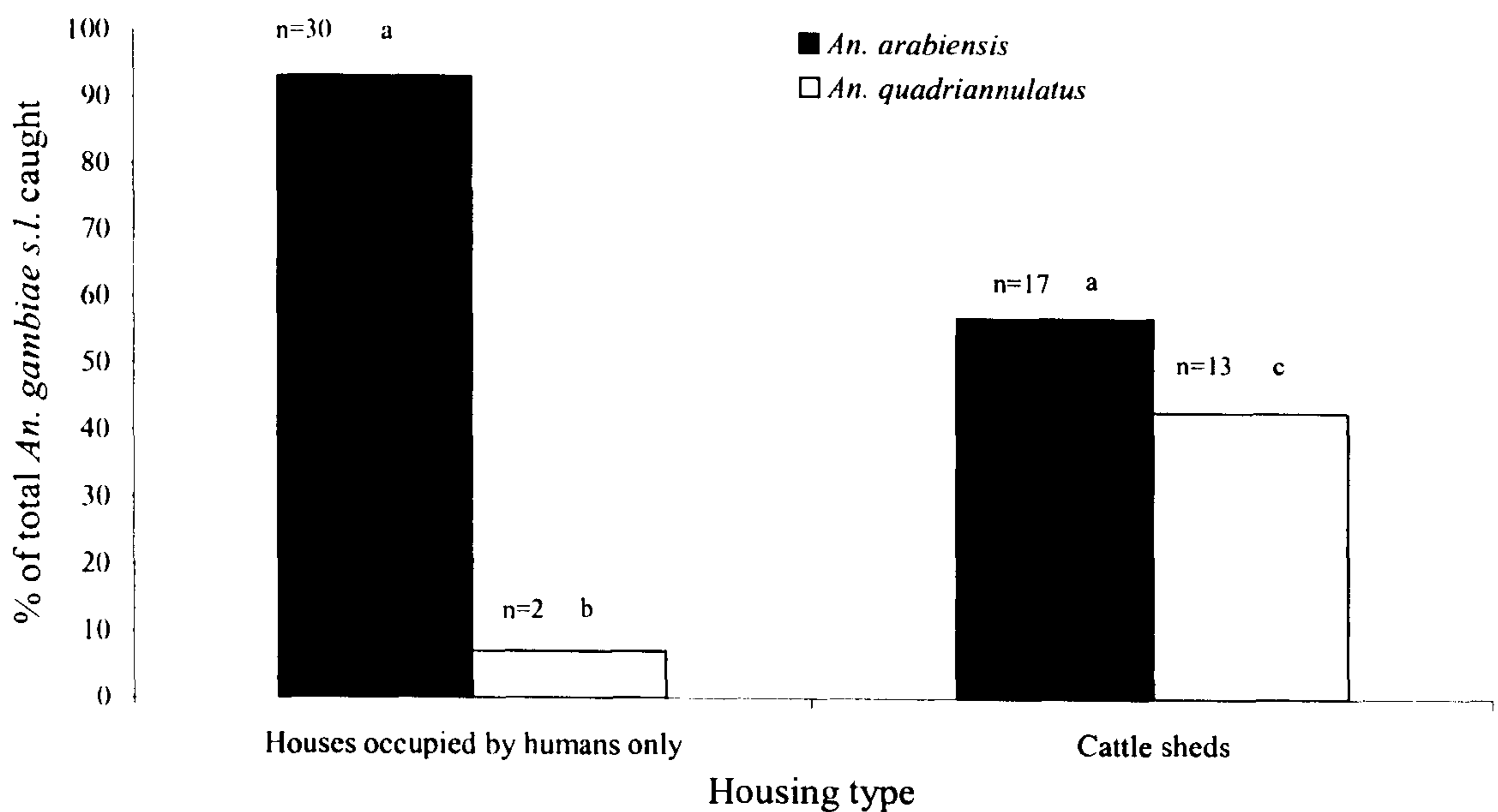

Figure 6.7. Distribution of *An. gambiae s.l.* caught in resting catches in human houses and cattle sheds in Babo and Abukako. The graph shows the proportion of *An. arabiensis* and *An. quadriannulatus* identified from the total number of *An. gambiae s.l.* caught at each housing type. n= total number of specimens identified; different letters indicate significant differences between the numbers caught at each housing type (χ^2 distribution, $P \leq 0.01$).

6.4.3 Sporozoite rates & bloodmeal analysis

Only one mosquito, an *An. arabiensis* specimen, from the light trap in the human house was found positive for the presence of *P. vivax* circumsporozoite protein (1/408 = 0.245%) (see table 6.3). No *P. falciparum* circumsporozoite positive specimens were recorded and no other species were found positive for circumsporozoite protein. Results from the bloodmeal analysis were disappointing since 71% of the bloodmeals analysed gave a negative result in the precipitin test. This was attributed to poor storage of the mosquitoes (the silica gel did not dry out the mosquitoes kept in eppendorfs sufficiently) and over digested bloodmeals. A summary of the positive bloodmeal identifications is given in table 6.4. No human blood-fed or bovine blood-fed positive *An. gambiae s.l.* mosquitoes were detected. The majority of the positive bloodmeals detected were of sheep origin and surprisingly the same number of chicken bloodmeals as bovine bloodmeals were detected.

Table 6.3. Results of circumsporozoite ELISA for *An. gambiae s.l.* caught in light trap catches and resting catches.

Species	circumsporozoite protein tested		
	<i>P. vivax</i>	<i>P. falciparum</i>	<i>P. malariae</i>
<i>An. arabiensis</i>	1/408 (0.245%)	0/408 (0%)	0/408 (0%)
<i>An. quadriannulatus</i> species B	0/328 (0%)	0/328 (0%)	0/328 (0%)

Table 6.4. A summary of the bloodmeal origin of mosquitoes caught in resting catches, identified by the precipitin test. H = human house, C = cattle shed, M = house occupied by both humans and animals. *Anopheles gambiae s.l.* includes data for *An. arabiensis* and *An. quadriannulatus*, which have been combined due to the small numbers.

Species	Origin of bloodmeals											
	Human			Bovine			Sheep			Chicken		
	H	C	M	H	C	M	H	C	M	H	C	M
<i>An. marshallii</i>	3	0	0	1	4	0	1*	9	1	0*	4	0
<i>An. chrystyi</i>	3	2	0	4	3	0	3	9	0	0	7	0
<i>An. demeilloni</i>	0	0	0	1	0	0	1	2	0	0	0	0
<i>An. gambiae s.l.</i>	0	0	0	0	0	0	2	7	0	1	0	1
TOTAL	8			13			34			13		

* An additional 11 *An. marshallii* specimens gave a positive precipitate when the bloodmeal was tested with both sheep and chicken antibodies. These data has been excluded from the table.

6.5 Discussion

O'Conner (1967) reported 34 species and 2 subspecies of anophelines in Ethiopia, with *An. gambiae s.l.*, *An. funestus*, *An. implexus*, *An. demeilloni*, *An. chrystyi*, *An. garnhami*, *An. kingi*, *An. longipalpis*, *An. nili*, *An. coustani*, *An. squamosus* and *An. marshallii* having been recorded in the Jimma area. *Anopheles funestus* has a relatively localised distribution, closely following that of *An. pharoensis* in Ethiopia. A major factor governing the distribution of *An. funestus* and *An. pharoensis* is the tendency of both species to breed in large, more or less permanent bodies of water where shade is

available. Such breeding sites can be found in swamps, along lake shores, in rice fields and in irrigation ditches, which are common in Gambella, Western Ethiopia and the Zwai area of Central Ethiopia where *An. funestus* and *An. pharoensis* have frequently been found (O'Conner, 1967; Krafsur, 1977; Nigatu *et al.*, 1994; Abose *et al.*, 1998). The absence of *An. funestus* (and *An. nili*) in both light trap collections and resting catches is therefore assumed to be a direct result of a lack of suitable breeding sites in the direct vicinity of the study area.

Light traps are often used for sampling afro-tropical anthropophilic anopheline mosquitoes and it is well established that the provision of a mosquito net to the occupants of a room containing a light trap influences the catch composition of the light trap (Lines *et al.*, 1991; Mboera *et al.*, 1998a). When no net is present in the room, the catch consists of fed, unfed and gravid mosquitoes. However, when a net is present and placed near a trap, unfed mosquitoes predominate, as in this study where 98% of the mosquitoes caught in light traps at each site were unfed. Use of a light trap and untreated bednet placed over cows in the cattle shed proved an effective method of sampling zoophilic mosquitoes. The net remained in place throughout the night and the cows inside the net were not disturbed by it. The proportion of certain mosquito species, such as *An. coustani*, *An. chrystyi* and *An. cydippis* caught in the light traps increased as the ratio of cattle to humans increased (table 6.1 & fig. 6.4), which indicates zoophilic behaviour in these species. *Anopheles marshallii* is commonly caught biting animals outdoors and contact with man appears to be rare (Gillies & Coetzee, 1987) although Maxwell *et al.* (1999) have reported members of the *An. marshallii* group in light traps hung next to nets 'baited' with humans in Tanzania. Members of the *An. marshallii* group have also been caught biting humans in Tanzania (Wilkes *et al.*, 1995). Furthermore, the presence of sporozoites in *An. marshallii* specimens from Tanzania suggests that they do bite humans frequently (Curtis *et al.*, 1999). Such behavioural differences are probably a reflection of differences between sibling species belonging to the *An. marshallii* group. Very few *An. marshallii* were caught in the human house (a mean of 3.2 per night) whereas many more were caught in the cattle shed (a mean of 33.8 per night). However, the mean number caught in the house occupied by humans and cattle was far higher than in the cattle shed (109.8 per night), possibly because breeding sites close to this catching station were more suited to *An. marshallii* and less suited to *An. gambiae s.l.* (fewer *An. gambiae s.l.* were caught at this catching station than in either the cattle shed or human house) (see fig. 6.4). Some species caught in the light traps tend to be exophagic (feeding outdoors), such as *An. coustani* and *An. cydippis* (Gillies & Coetzee, 1987) and their presence in the light

trap catch was therefore probably due to the virtual absence of hosts outdoors at the time of biting.

Analysis of the *An. gambiae s.l.* mosquitoes caught in the light traps revealed that more *An. arabiensis* were caught in the human house and the house occupied by humans and cattle than in the cattle shed. This would be expected for a mosquito that has been recorded with a high human blood index in this area (White *et al.*, 1980) where it is also the main malaria vector (Turner, 1972; Hunt *et al.*, 1998). In the cow shed, the proportion of *An. quadriannulatus* caught was much higher than the proportion of *An. arabiensis* caught (fig. 6.5 & table 6.5), which demonstrates the zoophilic behaviour of *An. quadriannulatus*. However, the proportion of *An. quadriannulatus* caught in the human house was much higher (35% of the total *An. gambiae s.l.* caught in the human house) than would be expected for a wholly zoophilic mosquito. Hunt *et al.* (1998) caught a total of 29 *An. quadriannulatus* mosquitoes in resting catches from the villages of Babo and Minko in the Jimma region, of which 10% came from human houses, 10% from houses occupied by humans and animals and the remaining 80% from cattle sheds. In this study, 13% of the *An. quadriannulatus* mosquitoes identified from resting catches originated from human houses, whereas 87% originated from cattle sheds, which closely agrees with the findings of Hunt *et al.* (1998). However, in the light trap catches 26% of the total number of *An. quadriannulatus* mosquitoes collected were caught in the human house, 14% from the house occupied by humans and cattle and 60% from the cattle shed. White *et al.* (1980) found no *An. quadriannulatus* in resting catches from human houses and an equal ratio of *An. arabiensis*: *An. quadriannulatus* in cattle sheds (see table 6.5 to compare with the results from this study).

In contrast with results from the light traps, the majority (93%) of the *An. gambiae s.l.* mosquitoes caught resting in human houses were identified as *An. arabiensis* whereas approximately half (57%) of those caught resting in cattle sheds were identified as *An. arabiensis*. This may explain why *An. quadriannulatus* species B has rarely been found in human houses because resting catches instead of light trap catches have been used to catch this species in the past (Turner, 1972; White *et al.*, 1980; Hunt *et al.*, 1998). Most of the cattle sheds that were visited in Babo and Abukako were more open structures that were less well built than the family house, a *Tukul* that used to be the family house and was in disrepair or a temporary structure to protect the cows. Cattle sheds were therefore less well protected from the elements than human houses and probably provided a more suitable resting environment for *An. quadriannulatus* than the more protected houses occupied by humans only. This demonstrates the importance of

using a variety of sampling methods when collecting mosquitoes in the field, since use of only one method will severely bias results.

Anopheles quadriannulatus species A is reported to be more exophilic (outdoor resting) and exophagic (outdoor feeding) than *An. quadriannulatus* species B (White, 1974a) and as mentioned in section 1.3, the association of *An. quadriannulatus* species A with humans has been recorded frequently but rarely referred to in literature. In Zimbabwe, Mpofu & Masendu (1986) used a human baited tent trap outdoors in a routine malaria survey since there was an absence of indoor biting but malaria cases were still being reported, which suggested an exophagic malaria vector population. Over a 3-month period the trap yielded a total of 147 specimens (7.5% *An. gambiae* s.s., 48.9% *An. arabiensis* and 43.6% *An. quadriannulatus*). However, the same trap baited with a sheep consistently resulted in catches dominated by *An. quadriannulatus*. Similar outdoor traps baited with a cow, a sheep or a human were used by Mpofu *et al.* (1993) in Zimbabwe to collect *An. gambiae* s.l.. Between 77 and 100% of the *An. gambiae* s.l. caught in the cow baited net and sheep baited net were identified as *An. quadriannulatus*. However, the proportion of *An. quadriannulatus* caught in human baited traps varied from 40% in early May to a peak of 100% in early June followed by a decline to zero in early July. In KwaZulu Natal, South Africa, *An. quadriannulatus* were caught from various locations in the following proportions: 1% from a human-baited net, 2% from window traps, 20% from a goat baited net, 36% from indoor spray catches from human huts and 41% from a pit shelter (Sharp *et al.*, 1984). Indoor house resting in human-only habitations of *An. quadriannulatus* in South Africa and Zimbabwe has also been reported by Hunt & Mahon (1986). Although, a more recent study in South Africa by Dekker & Takken (1998) found that significantly more *An. quadriannulatus* species A were caught in outdoor traps baited with either a calf or carbon dioxide than in traps baited with a human. The results of the laboratory experiments and the semi-field study described in chapter 3 indicate that these published observations of *An. quadriannulatus* species A being occasionally associated with humans are not atypical. Furthermore, the results from the current study indicate that whilst *An. quadriannulatus* species B is clearly more zoophilic than *An. arabiensis* (and laboratory strains of *An. gambiae* s.s.), it appears to behave in a similar manner to *An. quadriannulatus* species A.

Table 6.5. The ratio of *Anopheles arabiensis*: *An. quadriannulatus* caught in different habitats in the Jimma region of Ethiopia. Ratios quoted from the resting catches and light trap catches were estimated from data shown in figure 6.7 and 6.5 respectively.

Human house	Ratio of <i>An. arabiensis</i> : <i>An. quadriannulatus</i>		
	House with humans + cattle	Cattle shed	Reference
1 : 0	5-50 : 1	1 : 1	Resting catches, White <i>et al.</i> , (1980)
15 : 1	(no sample)	1 : 1	Resting catches, this study (figure 6.7)
2 : 1	3 : 1	1 : 2	Light trap catches, this study (figure 6.5)

The exophilic behaviour of certain species (*An. cydippis*, *An. coustani*) was apparent by the extremely low numbers caught or complete absence in resting catches (fig. 6.6). Many more *An. demeilloni* were caught resting in houses occupied by humans and animals than in either human houses or cattle sheds; this may be due to site specific differences such as house type and structure. *Anopheles marshallii* and *An. chrystyi* appeared to be endophilic since large numbers were caught resting indoors. It proved to be very difficult to find resting mosquitoes inside human houses and houses occupied by humans and animals and much more common to find mosquitoes resting in cattle sheds. Most of the human houses and houses occupied by humans and animals were *Tukuls*, which were very dark inside, full of smoke in the early morning (because fires are lit in the middle of the room and there is no chimney) and the ceilings and eaves were too high to reach by hand. It is also very possible that mosquitoes preferred to rest on the thatch roof/ ceiling rather than on the mud walls, in which case many resting mosquitoes may have been missed by the catching method used (i.e. two people searching with aspirators and torches for a fixed period of time). Abose *et al.* (1998) remarked that *An. arabiensis* from the Zwai region of Ethiopia preferred resting on thatched walls than on mud walls.

A better method to catch resting mosquitoes would have been to use a pyrethrum spray catch with a white sheet to catch knocked-down mosquitoes. However, this type of sampling method may also produce biased results since mosquitoes may escape during spraying and the immediate post-spray period and some mosquitoes may not be recovered because they are trapped in walls and ceilings (highly likely in a *Tukul* where cobwebs are also frequent). This method is also much more intrusive and difficult in a *Tukul*, since

most or all of the household objects are on the floor. Ribeiro *et al.* (1996) compared hand captured collections of mosquitoes inside human dwellings with the pyrethrum spray method and found that hand collections correlated well with space spray collections ($r^2=0.928$), although they tended to underestimate densities when pyrethrum catches were large.

Only one mosquito, an *An. arabiensis* specimen from the light trap in the human house, was found positive for *P. vivax* circumsporozoite protein. The sporozoite rate calculated from the total number of *An. arabiensis* caught was 0.245% (table 6.3), which is lower than commonly found in lowland tropical Africa but not unusually so for the area of the present study, since sporozoite infection rates appear to be very low in *An. arabiensis* mosquitoes collected from Ethiopia (see table 6.6). Several authors report studies where several hundred or thousand specimens have been dissected or tested for the presence of the circumsporozoite protein with no positive specimens (e.g. O'Conner, 1967 and Abose *et al.*, 1998; see table 6.6). The present study took place during the rainy season, in July and August of 2000. There was a lot of rain throughout the study period and possibly, the recruitment of new individuals into the population resulted in the low sporozoite rate. However, the occurrence of *P. vivax* in *An. arabiensis* is rare and although great care was taken to separate the thorax of each mosquito from the abdomen, the possibility of a false positive result associated with the presence of a bovine bloodmeal cannot be discounted (Lochouarn & Fontenille, 1999).

The human blood index (HBI) of *An. arabiensis* collected in various habitations in different parts of Ethiopia is also shown in table 6.6, which shows that the HBI generally decreases as the ratio of animals: humans increases. The direct impact of cattle kept in human habitations, on the level of malaria infection in the mosquito population is difficult to assess because of the extremely low sporozoite rates found in *An. arabiensis* in Ethiopia. White *et al.* (1972) studied *An. arabiensis* at Segera in Tanzania and found 5 sporozoite positive specimens out of a total of 1,578 dissected (0.32%). However, four of these sporozoite positive females were found to have fed on cows, suggesting that individual females of this species do not become habituated to a particular type of host. The presence of cattle in human habitations may provide some level of zoophylaxis in certain areas (Hadis *et al.*, 1997) yet conversely, the presence of cattle may also increase the human biting rate because zoophilic mosquitoes may be diverted from animals to a human host, for example *An. stephensi* in Pakistan (Hewitt *et al.*, 1994) (see section 1.3.3). In many parts of Ethiopia, it is common for people to live in close proximity to their animals. In this study, the mosquito catches from the light traps in the house

occupied by humans and cattle was approximately 2.5 times larger than in the human house. Therefore, it appeared that living next door to a cattle shed was better (in terms of mosquito numbers) than sharing the living space with cattle. People living in areas such as this would certainly benefit from insecticide treatment of livestock, as described by Rowland *et al.* (2001).

Table 6.6. The sporozoite rate and human blood index in *An. arabiensis* collected from indoor resting catches in Ethiopia.

Region	Sporozoite Rate ¹	Human Blood Index ²	Reference
Zwai Region (Central)	9/4513 (0.199%) dissections 0/334 (0%) cs-ELISA 0/274 (0%) dissections		Rishikesh (1966) quoted in Abose <i>et al.</i> (1998) Abose <i>et al.</i> (1998)
Awash Valley (South-east)	1/633 (0.15%) dissections 0/630 (0%) dissections		O'Conner (1967) ³
Shewa/ Sidamo provinces (South)	9/4954 (0.2%) dissections 0/402 (0%) dissections 0/56 (0%) dissections		
Kobo-Chercher (Welo province)	0/146 (0%) dissections 3/100 (3%) dissections		
Gambella (West)	156/8348 (1.87%) dissections	100% (human houses)	Krafsur (1977) ³
Jimma (South-west)	3/3000 (0.1%) dissections	100% (human houses) 46% (mixed houses) 0% (cattle sheds)	White <i>et al.</i> (1980)
Gambella (West)	2/261 (0.77%) <i>falciparum</i> + cs-ELISA 2/430 (0.47%) <i>vivax</i> + cs-ELISA	33% (human and mixed houses)	Nigatu <i>et al.</i> (1994) ³
Gerged, Wenji Area	55/3626 (1.52%) cs-ELISA 4/638 (0.63%) dissections		Amenesheva (1995) quoted in Abose <i>et al.</i> (1998)
Unknown		88% (mixed houses) 43% (cattle sheds)	Adugna & Petrus (1996) quoted in Hadis <i>et al.</i> (1997)
Ledi, Alibeti (East); Sille, Erbore (South); Itang, Jawe (West)		91.5% (human houses) 20.2% (mixed houses) 3.5% (cattle sheds)	Hadis <i>et al.</i> (1997)
Jimma (South-west)	4/148 (2.7%) <i>falciparum</i> + cs-ELISA		Hunt <i>et al.</i> (1998)

¹ The sporozoite rate is calculated by the number of dissected salivary glands positive for sporozoites divided by the total number of mosquitoes dissected or the number of positive mosquitoes for either the *P. falciparum* or *P. vivax* circumsporozoite protein divided by the total number tested. ² The type of habitation where mosquitoes were collected is given in parentheses. Mixed houses = houses occupied by humans and animals (e.g. sheep, goats, chickens, cats, cows). ³ Data assumed to be related to *An. arabiensis* since no *An. quadriannulatus* mosquitoes have ever been reported in the area and no other members of the *An. gambiae s.l.* complex have been recorded in Ethiopia.

Light traps with bednets were used with the normal residents of the houses (or sheds) because it was hoped that in this way it would be possible to identify what species were entering these dwellings to bite during the night. Whilst good numbers of mosquitoes were caught and clear differences between housing types can be seen, it is difficult to make direct comparisons between housing types because of host differences and numbers. Man biting catches directly measure which species come indoors at night to bite humans. However, there are problems associated with this method because of differences between the attractiveness of individual humans to different mosquito species (see section 3.4), human error and ethical objections to subjecting humans to mosquito bites and an increased risk of malaria. Furthermore, it is not possible to use an equivalent method to catch zoophagic mosquitoes without the presence of a human to catch the mosquitoes biting the cow.

A correlation between human bait catches and a CDC miniature light trap was observed at two sites in coastal Tanzania (Lines *et al.*, 1991 and Davis *et al.*, 1995) indicating that data from traps placed near bednets could be adjusted to give an estimation of the biting density. Lines *et al.* (1991) caught the same number of mosquitoes in three light traps as a team of two human catchers. No difference in the catch composition of *An. gambiae s.l.* and *Cx. quinquefasciatus* was observed and the parity and sporozoite rates of mosquitoes caught by the two methods were similar. In Burkina Faso, CDC light traps hung close to a sleeping human protected by an untreated bednet caught on average 1.08 times the number of mosquitoes caught from a human bait catch (Costantini *et al.*, 1998). Davis *et al.* (1995) reported that the sporozoite rate in anophelines caught in a light trap was more than twice that of anophelines caught on human baits and suggested that this may have occurred because the light traps were also catching resting mosquitoes or gravid mosquitoes were attracted to the light source and were attempting to exit the house during their ovipositional flight (this assumes that the host seeking mosquitoes caught in the light trap were younger than the resting or gravid mosquitoes, which may not be true). Thus there are also disadvantages of using light traps to catch host-seeking mosquitoes because the catch may consist of a mixture of mosquitoes in different physiological states, which is not apparent unless all mosquitoes are examined thoroughly. A new trapping method using a human bait under a specifically designed bednet to trap mosquitoes in a netting trap may overcome some of the problems observed with human bait catches or light traps (Mathenge *et al.*, 2002).

Results from this field study show that *An. quadriannulatus* species B does enter human occupied houses to feed (as indicated by the light trap catches) but has a tendency

to leave after feeding (as indicated by the resting catches). However, further fieldwork is needed to establish whether *An. quadriannulatus* species B actually feeds on humans. In the present study, the only bloodmeals identified from this species were of goat and chicken origin. The majority of the bloodfed *An. gambiae s.l.* females that were set-up for egg laying digested their meal without laying eggs (see section 6.4.2). This may have been because it was their first bloodmeal or because they had taken a partial bloodmeal that was not sufficient to mature the egg batch. Takken *et al.* (2002) have observed that *An. quadriannulatus* species A (from South Africa) requires multiple meals for completion of egg development. Therefore, a properly equipped insectary capable of offering these *An. gambiae s.l.* females a second bloodmeal may have considerably aided the attempt to start a colony. Such a colony would have been used to compare the behaviour of *An. quadriannulatus* species A with that of *An. quadriannulatus* species B in the olfactometer. The overall response of *An. quadriannulatus* species B in the olfactometer (see section 5.6) may also have given further indication of the exophilic nature of this species.

Very few bloodmeals were identified using the precipitin technique (table 6.5). Use of a bloodmeal ELISA may have produced results that were more accurate although poor storage of specimens or overdigested or incomplete bloodmeals are considered the likely cause of the large percentage of bloodmeals that could not be identified. Hii *et al.* (1991) identified 91.5% of mosquito bloodmeals with the ELISA technique up to 11 hours after ingestion. Mukwaya (1974) used the precipitin test to identify bloodmeals from *Ae. simpsoni* mosquitoes caught in Uganda and found that 38% of the meals were too far digested (>12 hours old) to permit identification; poor feeds and 'dark feeds' could not be identified. The only human bloodmeals identified were from *An. marshallii* and *An. chrystyi*, both species that would normally be associated with cattle (81% and 89% respectively of bloodmeals identified from these species were taken from animals). Rift Valley fever has been isolated from *An. chrystyi* from Nairobi, Kenya (Gillies & Coetzee, 1987) and members of the *An. marshallii* group caught in Tanzania have been found positive for the circumsporozoite protein (Curtis *et al.* 1999) and caught biting humans (Wilkes *et al.*, 1995) (as already mentioned) but neither *An. chrystyi* or *An. marshallii* have been implicated as disease vectors in Ethiopia. No sporozoites were found in *An. quadriannulatus* species B and therefore it cannot be implicated as a malaria vector. More detailed fieldwork using human and cow baited traps, indoors and outdoors, is needed to establish the true host-seeking behaviour of this mosquito. However, it is clear from this study that *An. quadriannulatus* species B was attracted to humans. Therefore,

An. quadriannulatus species B would not be a suitable alternative source of genes for zoophily for use in backcrossing studies such as those described in Chapter 5.

Chapter 7

MICROSATELLITE ANALYSIS OF *ANOPHELES QUADRIANNULATUS*

7.1 Introduction

The attraction of *An. quadriannulatus* species A to human odour described in sections 3.2, 3.3, 3.4 and chapter 5 and of *An. quadriannulatus* species B to humans in chapter 6 has not been documented previously. Possible contamination of the *An. quadriannulatus* SKUQUA colony with mosquitoes from the *An. gambiae s.s.* SUA colony was considered to be a conceivable explanation for the behaviour observed in section 3.2. Microsatellite analysis by Dr. S. Sinkins (University of Notre Dame, USA) in February and March 1999 revealed some SUA-sized alleles in a proportion of the *An. quadriannulatus* SKUQUA mosquitoes tested (see Appendix I and discussion in section 7.4). However, cytotoxic studies by Dr. A. Della Torre (University of Rome, Italy) did not reveal any signs of introgression of *An. gambiae s.s.* into mosquitoes from the *An. quadriannulatus* SKUQUA colony.

A new colony of *An. quadriannulatus* species A (SANGQUA strain) was established using material from Zimbabwe collected by Dr. R. Hunt (South African Institute of Medical Research, Johannesburg) in April 1999 since it was felt that it was not appropriate to continue experiments with a suspect colony. Comparisons between the behaviour observed in mosquitoes from both colonies will be discussed in the general discussion (chapter 8). This chapter describes a brief microsatellite analysis to compare allele sizes and frequencies at one locus¹⁵, 803, in the two colonies of *An. quadriannulatus* species A (SKUQUA from South Africa and SANGQUA from Zimbabwe); wild caught *An. quadriannulatus* species A from South Africa (courtesy of Dr. C. Roper, LSHTM, UK); wild caught *An. quadriannulatus* species B from Ethiopia and wild caught *An. gambiae s.s.* from Tanzania (courtesy of Dr. C. Roper).

Microsatellites are a class of dispersed repetitive DNA composed of dinucleotide repeats and consist of dispersed regions composed of variable numbers of dinucleotides repeated in tandem (Griffiths *et al.*, 2000). Microsatellites have repeat lengths of 6bp or less; they are co-dominant and relatively easy to score (Kamau *et al.*, 1999). Zheng *et al.* (1996) characterised and mapped approximately 150 microsatellite markers in *An. gambiae s.s.*. One of the problems of applying these markers in other species is that of null alleles. Null alleles occur when there is a variation in the sequence complementary to the primer and PCR (polymerase chain reaction) fails to amplify that fragment. Some

¹⁵ Locus - position of gene on the chromosome

microsatellite loci are situated among conserved regions of the sequence and some are situated in polymorphic sequence areas. Many of the *An. gambiae s.s.* markers have null alleles, even within *An. gambiae s.s.* populations, whilst others are consistent across species; the likelihood of ‘mismatch’ is much greater among more distantly related mosquitoes.

A subset of the *An. gambiae s.s.* microsatellites have been selected for use on *An. gambiae s.l.* species by screening for reliable amplification in *An. arabiensis*, *An. quadriannulatus*, *An. merus* and *An. gambiae s.s.*, indicating conservation of primer sequence and absence of null alleles (C. Roper, unpublished; personal communication). One locus, 803 (found on chromosome 2), stood out as particularly suitable for this study because of its very characteristic pattern in field caught South African *An. quadriannulatus* material when compared with other sibling species (data courtesy of C. Roper). Locus 803 was the locus most likely to indicate contamination of the *An. quadriannulatus* colony because it has shown very characteristic and limited polymorphic variation when compared to *An. gambiae s.s.*. This locus was also the most interesting locus to compare with the Ethiopian *An. quadriannulatus*, again because of the very characteristic and limited polymorphic variation. Hence, the following material was analysed:

1. *An. quadriannulatus* species A, SKUQUA colony (originating from South Africa, colonised for 4 years at the time of collection for this study; see section 2.1.2)
2. *An. quadriannulatus* species A, SANGQUA colony (originating from Zimbabwe, colonised for 1 year at the time of collection for this study; see section 2.1.3)
3. *An. quadriannulatus* species B, wild caught material from Ethiopia (see chapter 6)

and compared with data from the following material (courtesy of C. Roper):

1. *An. quadriannulatus* species A, wild caught material from breeding sites in the Kruger National Park, South Africa.
2. *An. gambiae s.s.*, wild caught material from Tanzania.

The aim of this study was to compare the genetic differentiation between wild caught *An. quadriannulatus* and colony material and to gain further insight into the issue of colony contamination. The term mosquito ‘population’ used in this chapter applies to the group of mosquitoes tested, either from wild habitats or from a mosquito colony.

7.2 Materials & Methods

7.2.1 Mosquito specimens & DNA extraction

Details of the material analysed are given in table 7.1. Individual DNA extraction was completed on 32 mosquito specimens taken from the *An. quadriannulatus* SKUQUA colony (on 20.8.1999; preserved in isopropanol) and 32 from the *An. quadriannulatus* SANGQUA colony (on 10.2.2000; preserved in isopropanol) (see section 2.1) using the salt precipitation method of Sunnocks and Hales (1996). Whole mosquitoes were placed in 1.5ml eppendorfs and left for two hours to allow the isopropanol to evaporate completely. Each mosquito was then crushed in 5 μ l proteinase K (20 μ g/ μ l) and 300 μ l TNES buffer¹⁶ was added to each eppendorf and used to rinse the pestle. Eppendorfs were incubated overnight at 37°C after which 85 μ l 5M NaCl was added and each eppendorf shaken hard to precipitate the proteins. Eppendorfs were then microfuged (14,000rpm for 5 minutes) and the liquid removed and placed in a newly labelled eppendorf containing an equal volume (390 μ l) of cold ethanol. The eppendorfs were microfuged (14,000rpm for 5 minutes) to form DNA pellets in the base of the tubes. The ethanol was then removed from each eppendorf and DNA pellets were rinsed in 700 μ l 70% ethanol. The DNA pellets were air-dried on the lab-bench for 1 hour and then dissolved in 50 μ l sterile distilled water. The DNA was then stored at -20°C until required.

Wild caught *An. quadriannulatus* species B from Ethiopia (see chapter 6) were also included in the analysis. Individual DNA extraction was completed on 32 specimens (collected on 11.8.2000) that had been identified to sibling species using the PCR method of Scott *et al.* (1993) (see section 2.6). A portion of crushed mosquito from the ELISA preparation described in section 6.3.2 was used for the DNA extraction process described in section 2.6.1. The DNA was then stored at -20°C until required.

Wild caught *An. quadriannulatus* species A from South Africa (37 specimens) and wild caught *An. gambiae s.s.* from Tanzania (28 specimens) previously analysed by C. Roper were included in the final analysis (see section 7.2.3) in order to compare wild caught specimens with those from the colonies.

¹⁶ 100ml TNES buffer = 5ml 1M Tris base pH7.5, 20ml 2M NaCl, 4ml 0.5M EDTA, 0.5g SDS, 71ml Water.

Table 7.1. Genetic variability at locus 803 for the five *An. gambiae s.l.* populations studied.

Strain	Population	Origin	Sample size	Number of alleles	χ^2 test of deviation from Hardy-Weinberg equilibrium		
					χ^2 value	d.f.	P value
Wild caught material	<i>An. quadriannulatus</i> species A	South Africa	37	2	0.0256	1	0.9873
	<i>An. quadriannulatus</i> species B	Ethiopia	32	2	0.3425	1	0.8426
	<i>An. gambiae s.s.*</i>	Tanzania	28	5	-	-	-
Colony material	<i>An. quadriannulatus</i> species A	South Africa	31	4	5.954	8	0.7445
	<i>An. quadriannulatus</i> species A	Zimbabwe	24	2	4.629	1	0.0988

* χ^2 and P values were not computed for *An. gambiae s.s.*. d.f.= degrees of freedom: one less than normal because allele frequencies were calculated from the observed data.

7.2.2 *Microsatellite analysis*

One microsatellite marker, 803, was selected for amplification. This marker has been previously mapped and described by Zheng *et al.* (1996) and is located on the 2R arm of chromosome 2. The primer sequences for this marker are as follows:

5' primer 5'-CTCGATAAATCCCGTCGGTG-3'
3' primer 5'-GTCGGTTTGAGGTTGTAAAGC-3'

The forward primer in each reaction was labelled with a fluorescent marker (HEX) compatible with ABI PRISM (Perkin-Elmer, Norwalk, CT) electrophoresis. Microsatellites were PCR amplified using 1 μ l DNA and 19 μ l PCR master mix¹⁷ for 40 cycles of 94°C for 25 seconds, 50°C for 1 minute and 68°C for 2 minutes terminated by a cooling at 5°C for 10 minutes. The PCR products were rinsed in 70% ethanol and then mixed with deionised formamide, loading dye and a GeneScan (Perkin-Elmer) size standard (350 Rox™ Applied Biosystems). An internal lane standard is essential for achieving high precision when sizing DNA fragments by gel electrophoresis and the size standard used was designed for sizing DNA fragments in the 35-350 base pair range. This provides 12 single stranded fragments, which allows extremely accurate sizing of DNA fragments.

A 'porous loading comb' was loaded with 0.6 μ l of the PCR product mixture of each sample and inserted into a high resolution horizontal polyacrylamide gel that was run on an ABI Prism 377 sequencer (Perkin-Elmer) for approximately 2.5 hours. Gels were analysed using ABI PRISM Genescan Analysis Software and Genotyper® DNA Fragment Analysis Software (Perkin-Elmer) to identify alleles.

¹⁷ PCR mastermix = 200 μ l Buffer 10x KCl (15mM MgCl), 200 μ l Primer A 10x, 200 μ l Primer B 10x, 20 μ l dNTP's, 20 μ l Taq, 1260 μ l sterile water.

7.2.3 Statistical analysis

Genotype frequencies were analysed by the χ^2 test to test for deviation from the Hardy-Weinberg equilibrium. Observed and expected frequencies of homozygotes and heterozygotes in all populations were calculated using the formula:

$$p^2 + 2pq + q^2 = 1$$

where p and q are the allele frequencies calculated from half the observed frequency of heterozygotes and the frequency of homozygotes for the allele concerned. This formula was adapted as follows where more than 2 alleles were concerned:

$$p^2 + 2pq + q^2 + 2pr + 2qr + r^2 = 1 \text{ (for 3 alleles)}$$

$$p^2 + 2pq + q^2 + 2pr + 2qr + r^2 + 2ps + 2qs + 2rs + s^2 = 1 \text{ (for 4 alleles)}$$

Differentiation among populations was assessed by F statistics (Wright, 1978) using the ARLEQUIN software package (version 2.000) (available at <http://anthropologie.unige.ch/arlequin/>). The fixation index, F_{ST} , was developed by Wright (1921) to quantify the inbreeding effect of population substructure. This index equals the reduction in heterozygosity expected with random mating at any one level of a population hierarchy relative to another, more inclusive level of the hierarchy (Hartl & Clark, 1997). F_{ST} is the informative statistic for examining the overall level of genetic divergence among subpopulations and has a theoretical minimum of 0 (indicating no genetic divergence) and a theoretical maximum of 1 (indicating fixation for alternative alleles in different subpopulations) (Hartl & Clark, 1997). Calculation of the F_{ST} value was therefore expected to give a good indication of the condition of the colonies being examined, since they were derived from a wild population. Wright (1978) suggested the following guidelines for interpretation of F_{ST} :

- The range 0 to 0.05 may be considered as indicating *little* genetic differentiation.
- The range 0.05 to 0.15 indicates *moderate* genetic differentiation.
- The range 0.15 to 0.25 indicates *great* genetic differentiation.
- Values above 0.25 indicate *very great* genetic differentiation.

F_{ST} is based on the analysis of variance of allele frequencies and an advantage of F_{ST} is that it can be weighted to take sample size differences into account (Wang *et al.*,

2001). Measures of genetic structure (F_{ST} values) were obtained using the absolute frequency of different alleles (reliable for samples of >20). An exact test of sample differentiation was performed using the Markov chain method (analogous to Fisher's exact test; Lanzaro *et al*, 1998) with the chain set at 1000 dememorization steps to achieve a significance level of 0.05.

7.3 Results

7.3.1 Allele frequencies

Alleles could be scored in all the wild caught *An. quadriannulatus* species B specimens (from Ethiopia), for 97% of the *An. quadriannulatus* species A SKUQUA strain and 75% of the *An. quadriannulatus* species A SANGQUA strain (see electropherogram in figure 7.1). There are three possible explanations for the PCR-failure to amplify product in some of the *An. quadriannulatus* species A SANGQUA strain mosquitoes:

1. Degradation of the DNA
2. Inhibition of the PCR due to a high concentration of DNA in the PCR reaction.
3. The presence of null alleles at a high frequency, such that there are homozygote null individuals in the population; this hypothesis can be eliminated by investigating heterozygote deficiency among those specimens that have amplified (see section 7.3.2).

An excess or deficit of heterozygotes in a population, as indicated by a deviation from the Hardy-Weinberg equilibrium could be indicative of either selection, non-random mating in the population or the presence of null alleles. No significant deviations from Hardy-Weinberg expectations for any of the mosquito populations sampled were found (see table 7.1).

Absolute allele frequencies for locus 803 in the wild populations and colonies tested are shown in figures 7.2 and 7.3 respectively. Wild caught *An. quadriannulatus* species A from South Africa was very distinct from wild caught *An. quadriannulatus* species B from Ethiopia, in that no alleles were shared (fig. 7.2). Wild caught *An. gambiae s.s.* from Tanzania shared one allele with *An. quadriannulatus* species A (135bp) but none with *An. quadriannulatus* species B. The majority of the alleles found in *An. gambiae s.s.* (124-129bp) were not found in *An. quadriannulatus* species A or species B.

Analysis of the *An. quadriannulatus* species A SANGQUA population (colony from Zimbabwe) revealed two alleles (133 and 135bp) closely resembling the wild caught *An. quadriannulatus* species A population from South Africa (fig. 7.3). However, the alleles found in the *An. quadriannulatus* species A SKUQUA population were inconsistent with the other two *An. quadriannulatus* species A populations tested; 3% possessed a rare 133bp allele whereas almost 34% possessed the 137bp allele (which was not found in the other *An. quadriannulatus* species A populations).

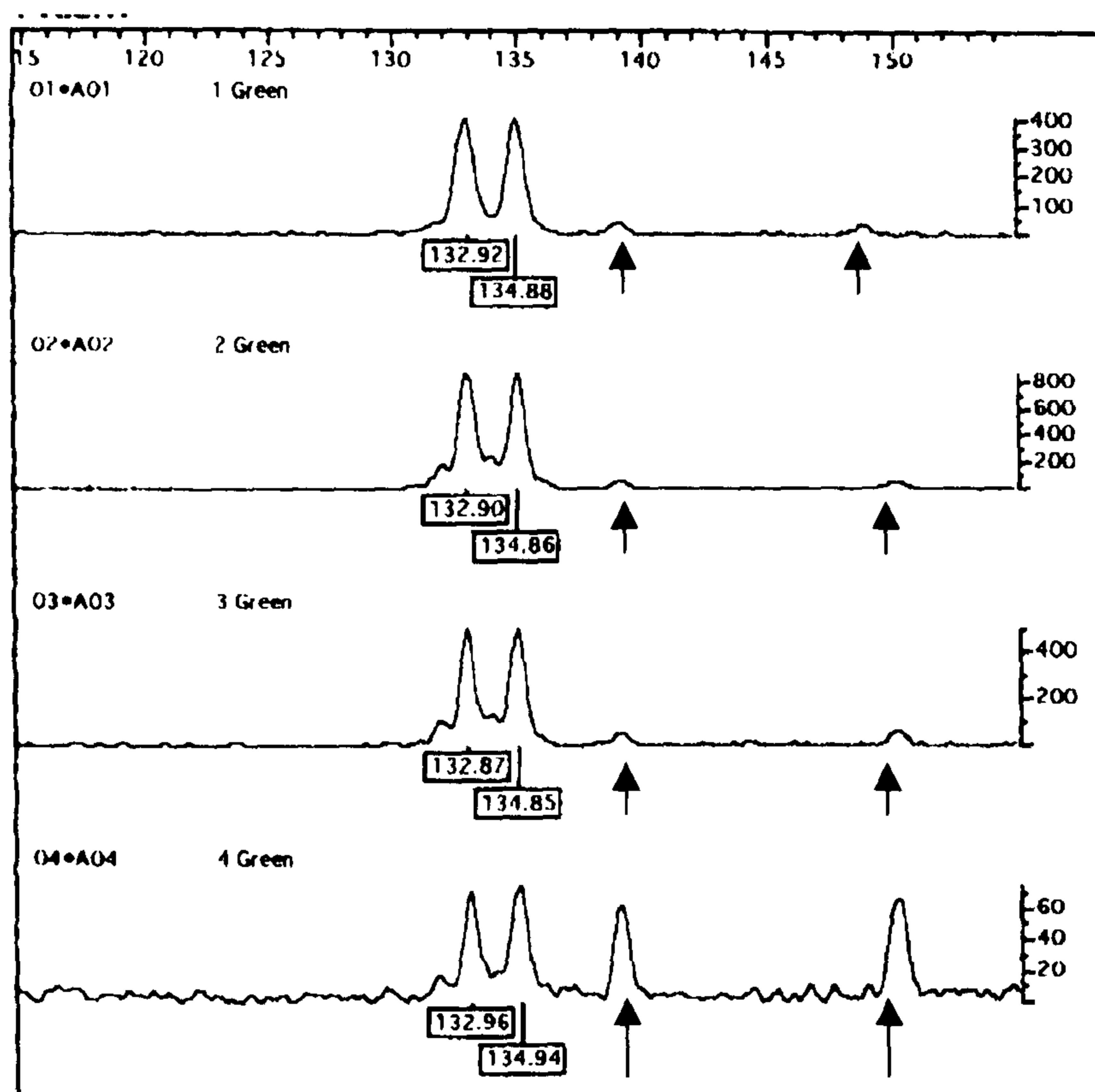

Figure 7.1. An electropherogram for four individuals of *An. quadriannulatus* species A SANGQUA strain mosquitoes at locus 803. Each fluorescence tracing (green for locus 803) is plotted on a scale of fragment size (nucleotides) (shown at the top of the diagram; the vertical scale represents fluorescence intensity). Labelled peaks represent microsatellite alleles with estimated allele size(s) shown below the peaks. Peaks at positions 139 and 150 (marked with an arrow) represent the internal lane standard. A mosquito was judged to be homozygous when only one major peak was found in the tracing and heterozygous when two major peaks were found in the tracing.

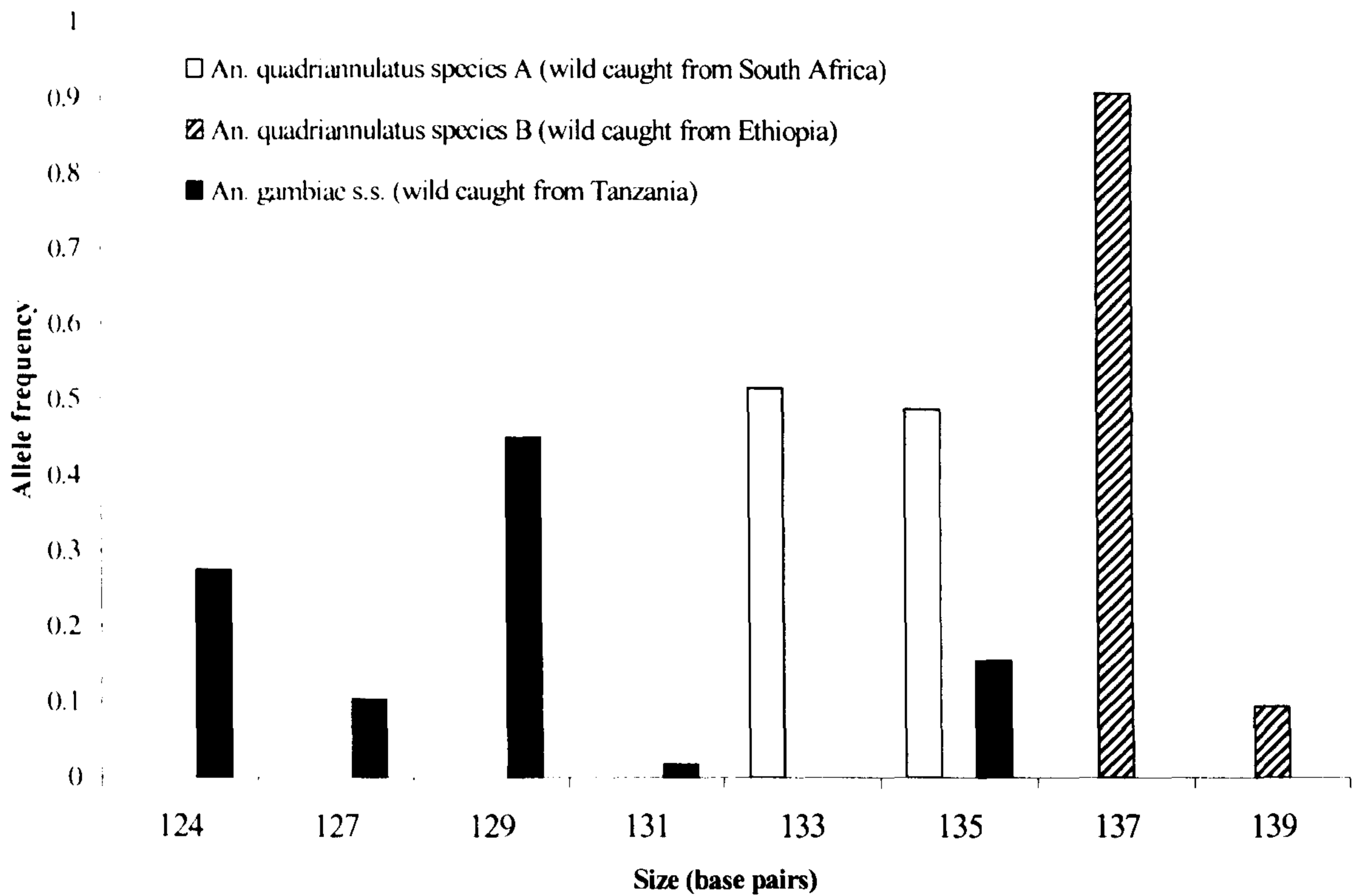

Figure 7.2. Allele composition of some wild caught *An. gambiae s.l.* populations at locus 803. Alleles are denoted by their total length (measured in base pairs).

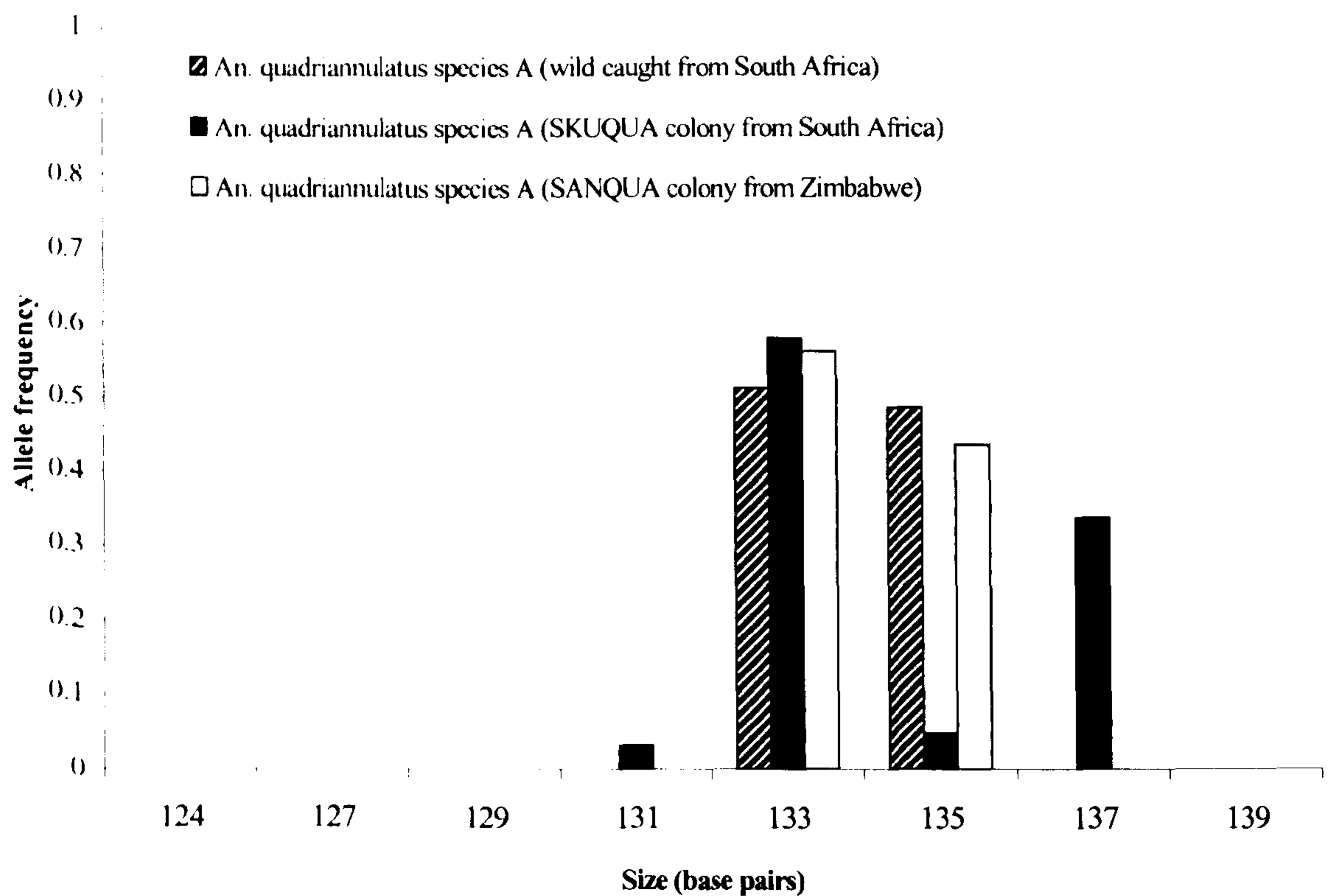

Figure 7.3. Allele composition of *An. quadriannulatus* species A colony populations at locus 803. Alleles are denoted by their total length (measured in base pairs). Data for wild caught *An. quadriannulatus* species A from South Africa from figure 7.2 have been included for comparison.

7.3.2 Genetic variability

F_{ST} values and their corresponding P values are shown in tables 7.2. and 7.3 respectively. Comparisons of *An. gambiae s.s.* with all other populations tested showed F_{ST} values above 0.25 indicating very great genetic differentiation (Wright, 1978), which would be expected since *An. gambiae s.s.* was being compared with other sibling species in the *An. gambiae* complex (table 7.2). Comparisons between *An. quadriannulatus* species B (from Ethiopia) and all other populations tested also showed F_{ST} values well above 0.25 (table 7.2), providing further evidence for the distinction between *An. quadriannulatus* species A and species B. The only F_{ST} value that was not significant ($P>0.05$) was the comparison between the *An. quadriannulatus* species A SANGQUA colony (from Zimbabwe) and the wild caught *An. quadriannulatus* species A population from South Africa (table 7.3).

Table 7.2. Pair-wise F_{ST} values for each pair of *An. gambiae s.l.* populations studied. SKUQUA = *An. quadriannulatus* species A SKUQUA strain (colony originating from material from South Africa); SANGQUA = *An. quadriannulatus* species A SANGQUA strain (colony originating from material from Zimbabwe); WILD SA = *An. quadriannulatus* species A (wild caught material from South Africa); WILD GA = *An. gambiae s.s.* (wild caught material from Tanzania); WILD ET = *An. quadriannulatus* species B (wild caught material from Ethiopia).

	SKUQUA	SANGQUA	WILD SA	WILD GA
SKUQUA	-	-	-	-
SANGQUA	0.16818	-	-	-
WILD SA	0.19870	-0.03019	-	-
WILD GA	0.35870	0.35261	0.35573	-
WILD ET	0.45239	0.67055	0.64712	0.57524

Table 7.3. P values for pair-wise F_{ST} between populations. See table 7.2 for explanation of abbreviations.

	SKUQUA	SANGQUA	WILD SA	WILD GA
SKUQUA	-	-	-	-
SANGQUA	0.00901±0.0091	-	-	-
WILD SA	<0.0001	0.84685±0.0389	-	-
WILD GA	<0.0001	<0.0001	<0.0001	-
WILD ET	<0.0001	<0.0001	<0.0001	<0.0001

7.4 Discussion

Mosquitoes from the *An. quadriannulatus* colony were tested using a wide range of microsatellite markers (not including locus 803) by Dr. S. Sinkins (University of Notre Dame). Six markers were found showing some degree of overlap in the allele size range between mosquitoes from the *An. gambiae s.s.* SUA colony and the *An. quadriannulatus* SKUQUA colony (held at the University of Notre Dame) (see Appendix I). A further 7 markers tested showed separate non-overlapping allele sizes for a number of mosquitoes collected from the *An. quadriannulatus* colony in 1998, but not in mosquitoes collected in 1999 from colonies of *An. quadriannulatus* kept in Wageningen (The Netherlands) or in Notre Dame (USA). This data suggested contamination of the *An. quadriannulatus* colony (sometime in 1998) with mosquitoes from the *An. gambiae s.s.* colony. However, the SUA-sized alleles found in *An. quadriannulatus* could have been rare alleles that had been lost in other colonies due to extensive bottlenecks. Furthermore, allele sizes reported for locus 46 (shown in Appendix I) are not consistent with other published data for this locus in *An. gambiae s.s.*. Unfortunately this study was limited due to a lack of stored material.

The present study investigated one locus, which, whilst being indicative can only provide a limited amount of information regarding genetic variability among the mosquito populations studied. Nevertheless, analysis of allele distribution and F_{ST} values among the sibling species studied revealed some interesting differences. Firstly, *An. quadriannulatus* species A (from South Africa) was very distinct from *An. quadriannulatus* species B (from Ethiopia) in that no alleles were shared between these two sibling species. This is a new finding that may prove to be a useful tool to separate *An. quadriannulatus* species A from *An. quadriannulatus* species B (at present the widely used PCR identification system developed by Scott *et al.* (1993) does not separate *An. quadriannulatus* species A from *An. quadriannulatus* species B).

Secondly, the *An. quadriannulatus* species A SANGQUA colony appeared to reflect very closely what was observed in the wild caught *An. quadriannulatus* species A mosquitoes from South Africa. This similarity can be seen in figure 7.3 and tables 7.2 and 7.3. Hence there is no reason to doubt that behavioural experiments performed with this colony from section 3.3 onwards were fairly representative of the wild population. This indicates that the attraction to humans observed in the SANGQUA strain may be naturally present in this species. The *An. quadriannulatus* species A SKUQUA colony possessed some inconsistent alleles but the more common *An. gambiae s.s.* sized alleles were not found in this colony and all *An. quadriannulatus* populations tested showed very

great genetic differentiation from *An. gambiae s.s.*. However, these results cannot confirm or reject the contamination hypothesis, although they do suggest that this colony was no longer representative of the wild population. The SKUQUA colony had been in the laboratory for 4 years at the time material was collected for this study and was therefore probably more adapted to laboratory conditions than the SANGQUA colony, which had only been in the laboratory for one year.

Depending on the need, laboratory colonies are either representative of the field populations from which they originated or serve as a stable standard to which other populations may be compared (Munstermann, 1994). Norris *et al.* (2001) examined microsatellite polymorphism at nine loci on chromosome 3 among two colonies and a wild population of *An. gambiae s.s.* and found that microsatellite polymorphism was dramatically reduced in the two laboratory colonies. This reduction in microsatellite polymorphism was attributed to the founder effect i.e. use of a few individuals to start a colony and the possibility that many rare alleles were never sampled or were lost within a few generations of laboratory colonisation. Munstermann (1994) found a reduced number of isozyme alleles among laboratory strains of *Aedes aegypti* when compared with field populations. However, in the present study, the *An. quadriannulatus* species A SKUQUA colony showed a higher degree of polymorphism at locus 803 than either the SANGQUA colony or the wild caught *An. quadriannulatus* species A mosquitoes from South Africa. None of the populations examined showed deviation from the Hardy-Weinberg equilibrium, indicating the presence of random mating and no selection pressures (at this locus). Lanzaro *et al.* (1998) demonstrated that gene flow varied among different regions within the *An. gambiae* genome and therefore analysis of at least 5 informative loci would be expected to provide more information regarding the genetic variability in these *An. quadriannulatus* colonies.

Chapter 8

GENERAL DISCUSSION & CONCLUSIONS

8.1 General Discussion

Despite the difficulties in rearing and testing *An. quadriannulatus* in the laboratory, the studies presented in this thesis provide clear evidence that this sibling species is not wholly zoophilic, as had been previously believed. *Anopheles quadriannulatus* is a difficult mosquito to rear, mainly because of the low frequency of mating within the laboratory cage but also perhaps because of its exophilic behaviour in the wild that cannot be expressed in the laboratory. The exophilic behaviour of *An. quadriannulatus* was almost certainly the main reason for the low response observed in the olfactometer studies (section 3.2, 3.4, 4.2, chapter 5). Mukwaya (1976, 1977) observed the same phenomenon with exophilic *Ae. simpsoni* in an olfactometer and a Y-tube and other authors have mentioned the difficulties that exophilic species have in negotiating barriers or small apertures (Gillies & Coetzee, 1987; Snow, 1987). The results from the microsatellite analysis presented in chapter 7, showed that the *An. quadriannulatus* SKUQUA population was no longer representative of the wild population in South Africa. However, the SANGQUA population that had been in the laboratory for only one year was genetically similar to wild caught material from South Africa. Interestingly, the response of the SKUQUA strain in the olfactometer was in general much higher (10-41%) than that of the SANGQUA strain (6-10%) and perhaps adaptation of the SKUQUA strain to laboratory conditions involved some degree of selection for endophilic behaviour. Therefore, it is recognised that other behaviours such as resting or house entering behaviour, in addition to host preference, may be expressed or influenced within the confines of an olfactometer and this should be investigated further.

The original aim of this study (see chapters 1 and 5) was to investigate the possibility of altering the host preference of *An. gambiae s.s.* by crossing this sibling species with *An. quadriannulatus*. The studies described in sections 3.1, 3.4 and 4.1 demonstrated that *An. gambiae s.s.* responds very well in the olfactometer. Therefore, it was considered that a change in the host preference of *An. gambiae s.s.* in hybrid and backcrossed mosquitoes (chapter 5) could be measured accurately using the olfactometer and suitable standard odour combinations (see section 4.1).

The preliminary studies with *An. quadriannulatus* species A in the olfactometer (section 3.2) that demonstrated attraction to human odour, even in the presence of cattle

odour, were very unexpected because this species has rarely been observed biting or attracted to humans in the field and almost never found containing human blood (see section 1.3.4). Several possible explanations for these unexpected results were proposed. Firstly, it was thought that feeding the *An. quadriannulatus* SKUQUA colony on human blood had selected for human feeding behaviour in the colony. Laarman (1958) fed *An. atroparvus* on rabbits in the laboratory and observed a similar phenomenon. However, results from the semi-field study in section 3.3 showed that the *An. quadriannulatus* SANGQUA colony was also attracted to (and fed on) humans. At the time of these experiments, the SANGQUA colony had been in the laboratory for 4 months and had never been fed on human blood. This semi-field study also supported the results from the olfactometer studies. In the light of the behaviour of *An. quadriannulatus* in the laboratory, it would be interesting to study the effect of previous experience on the host choice of blood-deprived females. Mwandawiro *et al.* (2000) showed that the feeding pattern of certain *Culex* species could be influenced by repeated contact with a particular host rather than being controlled entirely by a fixed behaviour.

Secondly, it was hypothesised that contamination of the *An. quadriannulatus* SKUQUA colony by an individual (or individuals) from the *An. gambiae s.s.* colony may have caused a change in the behaviour of *An. quadriannulatus*. Microsatellite analysis of colony material (see chapter 7 and Appendix I) was inconclusive but the contamination hypothesis was not supported by a cytotoxic analysis, which should reveal evidence of introgression because entire chromosomes are examined rather than one specific region. However, in the light of a possible contamination of the SKUQUA colony, the SANGQUA colony was established and used for all experiments from section 3.3 onwards.

A third possible explanation for the contrast between the results in this thesis and the results of another olfactometer study with *An. quadriannulatus*, which showed no attraction to human odour (Dekker *et al.*, 2001a) may have been due to the use of different human subjects with different degrees of attractiveness to *An. quadriannulatus*. This hypothesis was tested in section 3.4, by testing the odour from the individual (HP) used in the experiments presented in 3.1 to 3.3 against the odour from the individual (TD) used in the laboratory study described by Dekker *et al.* (2001a) and in the field study described by Dekker & Takken (1998). It was found that whilst there was no difference in the response of *An. gambiae s.s.* to these individuals, *An. quadriannulatus* preferred the odour from the individual (HP) used in sections 3.1 to 3.3. However, *An. quadriannulatus* showed no preference for the control port or the human odour port when odour from

individual TD was tested. This may explain why no *An. quadriannulatus* were caught in a human baited trap in South Africa (Dekker & Takken, 1998). This hypothesis is further supported by a study by Braks & Takken (1999) that showed that the sweat of individual TD was chemically different from that of other individuals tested. This finding further highlighted the need for a standard odour that can be used repeatedly to allow more accurate comparisons between experiments and avoid bias resulting from the use of the odour from one person. The skin washings that were prepared for this purpose (see chapter 4) proved to be highly effective, although it should be noted that the human skin washing appeared to have a shelf life of approximately 12 months at 4°C, therefore freezing the skin washing at -70°C may have prevented the loss of important volatiles. However, it is important to note that we still do not know what constitutes “host odour”, as far as a mosquito is concerned. Current research provides a basis with which to work with but the inconsistencies in many studies suggest that other, yet to be found important compounds, confer specificity.

It was also postulated that the behaviour of *An. quadriannulatus* may have been influenced by the ambient temperature. The *An. quadriannulatus* colonies were reared and tested at 27±1°C, which is (on average) slightly warmer than conditions in southern Africa. In Zimbabwe, Mpofu *et al.* (1993) reported catching a majority of *An. quadriannulatus* in human baited traps in late May and early June (in the winter season when temperatures are between 13 and 20°C), and a majority of *An. arabiensis* from early June onwards. In South Africa Dekker & Takken (1998) caught no *An. quadriannulatus* in a human baited trap in March/April (W. Takken, personal communication) (when temperatures are a minimum and maximum of 13 and 28°C respectively). However, these differences could be due to differences in trap design, human bait used or geographical factors. Mukwaya (1977) reared and tested a zoophilic strain of *Ae. simpsoni* at two different temperature ranges (23-24°C and 27-28°C) and found no difference in the host choice of either culture. Both strains of *An. quadriannulatus* tested outdoors in section 3.3 showed similar behaviour as they did in the olfactometer despite average temperatures ranging from 15-21°C. Similar night-time and early morning temperatures were also observed whilst catching *An. quadriannulatus* species B in Ethiopia. Therefore, differences in ambient temperatures do not seem to have affected host choice.

Coetzee (1987) remarked that because *An. quadriannulatus* has (so far) never been incriminated in malaria transmission, the control of this species is unnecessary. At present, this statement has not been contradicted although it should be noted that there

may be 'serious implications for malaria control should *An. quadriannulatus* be shown to be anthropophilic to any degree' (Coetzee & Hunt, 1985). It is highly probable that since *An. quadriannulatus* species A inhabits many areas of southern Africa where there are few humans, the availability of human biting is so low that for that reason alone it could not support malaria transmission. On the other hand, *An. quadriannulatus* species B in Ethiopia can be found in close association with humans but has never been incriminated as a malaria vector or tested in the laboratory for susceptibility to malaria parasites. The results of the field study presented in chapter 6 demonstrated that whilst *An. quadriannulatus* species B is clearly more zoophilic than *An. arabiensis*, it is also attracted to humans. The importance of using different collection methods to trap mosquitoes in the field was also highlighted in chapter 6; light trap catches in houses occupied by humans only yielded 35% *An. quadriannulatus* and 65% *An. arabiensis* whereas more than 90% of *An. gambiae s.l.* found resting in houses occupied by humans only were identified as *An. arabiensis*, and less than 10% as *An. quadriannulatus*. White (1974a) recognised that *An. quadriannulatus* from Ethiopia was more often found in close association with humans than the South African form. This is not surprising because in Ethiopia humans often share their living space with their animals. Human bloodmeals from *An. quadriannulatus* species B seem to be rare, and malaria infections even rarer therefore the probability of *An. quadriannulatus* species B (or A) being a vector species appears remote.

The behaviour of *An. quadriannulatus* is clearly distinct from *An. gambiae s.s.* and *An. arabiensis* (see table 1.3.1 and 1.3.2) but *An. quadriannulatus* is not strictly zoophilic. Gillies (1964) demonstrated that natural populations of *An. gambiae s.s.* show a certain degree of polymorphism for host preference and this seems to be the case for *An. quadriannulatus*. Thus it would appear that *An. quadriannulatus* behaves in a similar manner to other zoophilic species, such as *An. fluviatilis* species T in India. Hewitt *et al.* (1994) performed experiments in Pakistan where humans live in close proximity to cattle and concluded that the more zoophilic the species, the greater the increase in the human biting rate when near livestock. This phenomenon occurred not only with anophelines but also with culicines and may explain the results of the semi-field study described in section 3.3 where approximately 50% of the bloodmeals were taken on the human host stationed next to the calf.

The work in this thesis clearly contradicts previous views that the zoophilic behaviour seen in *An. quadriannulatus* species A is completely rigid (Coetzee, 1987; Coetzee & Hunt, 1985; Coetzee *et al.*, 2000; Davidson, 1964a & b; Dekker & Takken,

1998; Dekker *et al.*, 2001a, Hunt *et al.*, 1998). However, the anthropophilic behaviour of *An. gambiae s.s.* appears to be a genetically extremely stable character. In evolutionary terms, this may not be surprising. *Anopheles gambiae s.s.* is highly adapted to human feeding and human habits (such as the highly anthropophilic behaviour, indoor resting, larval breeding habits, late night biting, pre-diuresis and human-specific blood filtration mechanisms; see section 1.3.4) whereas *An. quadriannulatus* has been proposed as the ancestral *An. gambiae* species due to its behavioural characteristics, relict distribution, tolerance of fairly temperate conditions and its chromosome arrangement for which those other members of the *An. gambiae* complex may be derived (Coluzzi *et al.*, 1979; see figure 8A). Coluzzi *et al.* (1979) used the distribution of fixed paracentric inversions¹⁸ to infer phylogenetic relationships between sibling species, which is based on the assumption that all existing inversions are monophyletic in origin, i.e. all carriers of a particular gene order trace their ancestry to a single chromosome (García *et al.*, 1996). This assumption is supported by analysis of the Xag inversion system (indicating the close relationship of *An. gambiae s.s.* and *An. merus*) (García *et al.*, 1996) and evidence of introgression between *An. gambiae s.s.* and *An. arabiensis* (Della Torre *et al.*, 1997). Analysis of ribosomal DNA has suggested a different phylogeny with *An. gambiae s.s.* and *An. arabiensis* as closely related and *An. quadriannulatus* holding the central position between them and the salt water breeders (Collins *et al.*, 1990; see figure 8B). However, the fact that *An. gambiae s.s.* and *An. arabiensis* are widely sympatric and hybrids are found (rarely) in nature (Bryan, 1979; Coluzzi *et al.*, 1979; Petrarca *et al.*, 1991; White, 1971, 1974a) further supports the former phylogenetic relationship. Della Torre *et al.* (1997) suggested that *An. gambiae s.s.* acquired two inversion systems, 2Rb and 2La, from *An. arabiensis* through introgression, which then allowed it to expand from its primitive forest distribution into drier zones. Inversions on both arms of chromosome 2 have been associated with differences in the seasonality of breeding, adaptation to natural vs. human-disturbed habitats, host preference and habitat selection such as indoor or outdoor resting (Della Torre *et al.*, 1997, see section 1.3.4).

Very few physiological studies have been carried out with *An. quadriannulatus* because of its non-vector status. It has been shown that *An. quadriannulatus* species A requires multiple bloodmeals for completion of egg development (Takken *et al.*, in press) and that it is susceptible to both malaria (Takken *et al.*, 1999) and the human filaria, *Wuchereria bancrofti* (Hunt & Gunders, 1990). Studies regarding the feeding

¹⁸ Paracentric inversion – a form of chromosomal mutation (not involving the centromere) by means of an intrachromosomal reversal of a block of genes, e.g. the hypothetical gene arrangement of ABCDEFG may become ABEDCFG after rearrangement (White, 1974b).

mechanisms and blood digestion utilised by *An. quadriannulatus* and the more opportunistic sibling species *An. arabiensis*, may therefore help to explain some of the evolutionary processes involved in the adaptation of *An. gambiae* to human feeding.

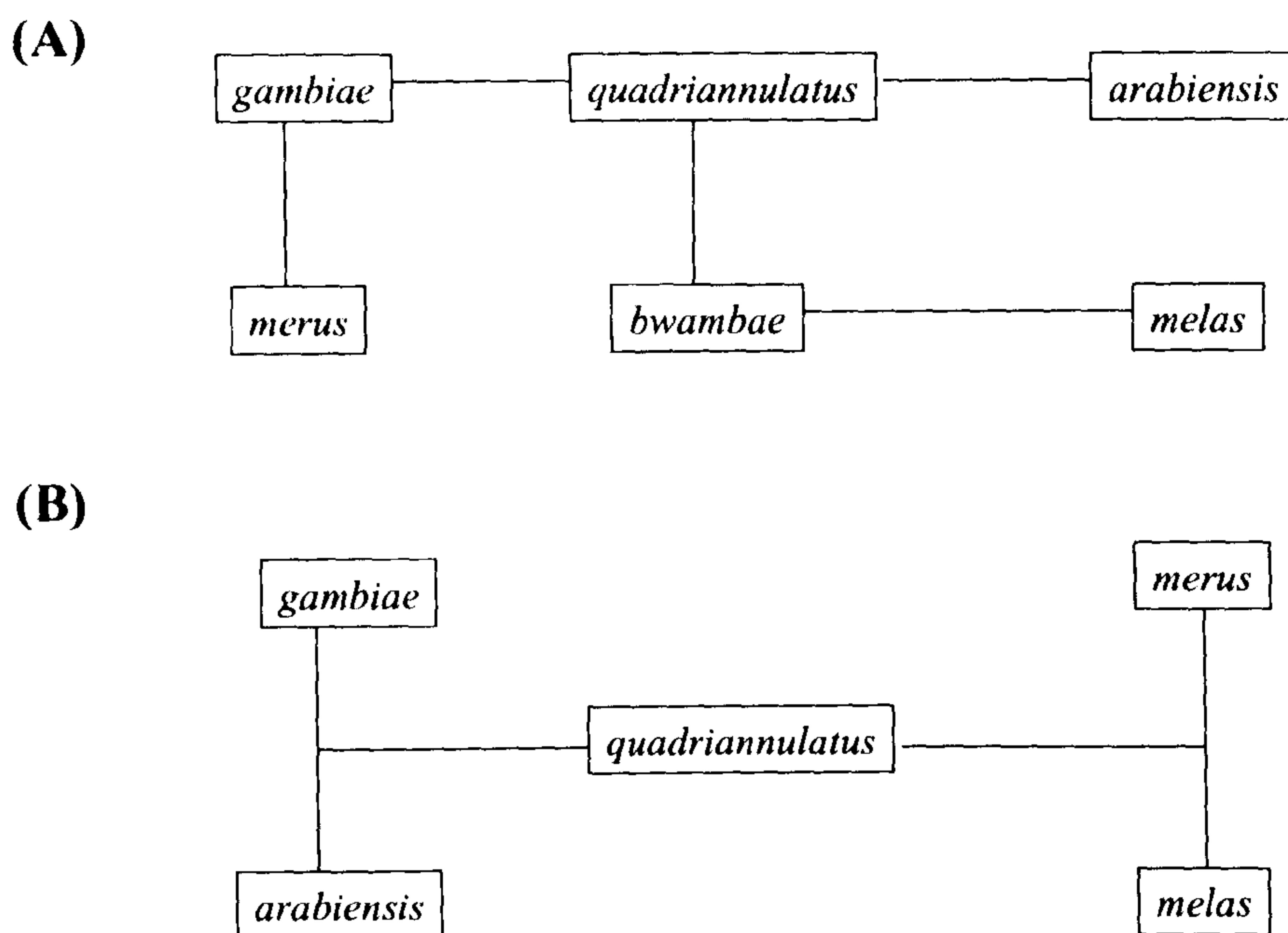

Figure 8. (A) Phylogeny of members of the *An. gambiae* complex based on distribution of chromosomal inversions (Coluzzi *et al.*, 1979). (B) Phylogeny of members of the *An. gambiae* complex based on molecular analysis of rDNA (Collins *et al.*, 1990).

The backcrossing experiments described in chapter 5 showed that anthropophilic behaviour in *An. gambiae s.s.* is extremely stable. The zoophilic index of *An. gambiae s.s.* did not change significantly after crossing with *An. quadriannulatus*. There was no significant difference in the zoophilic index of mosquitoes from all three backcrosses to *An. quadriannulatus* and that of *An. gambiae s.s.*, or any of the backcrosses to *An. gambiae s.s.*. Thus the genes originating from *An. quadriannulatus* appeared to have no effect on the host preference of *An. gambiae s.s.* and a small proportion of genes from *An. gambiae s.s.* seemed to have a predominant effect on the host preference of *An. quadriannulatus*. This means that selection against such a strong characteristic will be very difficult and although any shift to decrease the degree of human biting by *An. gambiae s.s.* would be beneficial to disease transmission, it remains to be seen whether the use of genes for zoophily would merit the effort required to select against such a stable trait. Furthermore, if a stable zoophilic strain of *An. quadriannulatus* could

be identified, then the use of genes for zoophily to control *An. gambiae s.s.* is only likely to be successful in certain areas, including regions where alternative hosts are abundant and kept apart from humans. With an 'unstable zoophilic strain' such as the strains used in these experiments, this type of control method would be unlikely to succeed. The results presented in this thesis give further weight to the anecdotal evidence of *An. quadriannulatus* found in association with humans in the field. Hunt & Mahon (1986) suggested that there was a tendency to dismiss the possibility that *An. quadriannulatus* can constitute a significant proportion of hut resting populations of the *An. gambiae* complex (except where mixed human and animal habitations were concerned). This certainly seems true and further field studies using standardised trapping methods at different times of the year will be required before one could be sure that the notion of *An. quadriannulatus* as a rigidly and wholly zoophilic member of the *An. gambiae* complex should be modified.

8.2 General Conclusions

1. *Anopheles gambiae s.s.* is highly anthropophilic.
2. Anthropophily in the *An. gambiae s.s.* SUA colony is an extremely stable trait.
3. *Anopheles quadriannulatus* is not wholly zoophilic.
4. *Anopheles quadriannulatus* species B is more zoophilic than *An. arabiensis* in Ethiopia but also shows some degree of attraction to humans.
5. Standard odour baits are essential for olfactometer experiments that need to be repeatable, unbiased, unintrusive and convenient.
6. Further investigations regarding the influence of an olfactometer and laboratory adaptation on the behaviour of exophilic mosquitoes are required.
7. Further field studies using a variety of standardised trapping methods are necessary to confirm the experimental work presented in this thesis.
8. Successful exploitation of the genes for zoophily will only be possible with a stable zoophilic strain.

BIBLIOGRAPHY

- Abose, T., Yeebiyo, Y., Olana, D., Alamirew, D., Beyene, Y., Regassa, L. & Mengesha, A. (1998) Re-orientation and definition of the role of malaria vector control in Ethiopia. *World Health Organisation Report, WHO/MAL/98.1085*.
- Acree, F.Jr., Turner, R.B., Gouck, H.K., Beroza, M. & Smith, N. (1968) L-Lactic acid: A mosquito attractant isolated from humans. *Science* **161**, 1346-1347.
- Agelopoulos, N., Birkett, M.A., Hick, A.J., Hooper, A.M., Pickett, J.A., Pow, E.M., Smart, L.E., Smiley, L. D.W.M., Wadhams, J. & Woodcock, C.M. (1998) Exploiting semiochemicals in insect control. *Pesticide Science* **55**, 225-235.
- Arredondo-Jiménez, J.I., Bown, D.N., Rodroquez, M.H., Villarreal, C., Loyola, E.G. & Frederickson, C.E. (1992) Tests for the existence of genetic determination or conditioning in host selection by *Anopheles albimanus* (Diptera: Culicidae). *Journal of Medical Entomology* **29**, 894-897.
- Arredondo-Jiménez, J.I., Gimnig, J., Rodriguez, M.H. & Washino, R.K. (1996) Genetic differences among *Anopheles vestipennis* subpopulations collected using different methods in Chiapas state, Southern Mexico. *Journal of the American Mosquito Control Association* **12**, 396-401.
- Bar-Zeev, M., Maibach, H.I., & Khan, A.A. (1977) Studies on the attraction of *Aedes aegypti* (Diptera: Culicidae) to man. *Journal of Medical Entomology* **14**, 113-120.
- Becker, N., Zgomba, M., Petric, D. & Ludwig, M. (1995) Comparison of carbon dioxide, octenol and a host-odour as mosquito attractants in the Upper Rhine Valley, Germany. *Medical & Veterinary Entomology* **9**, 377-380.
- Birkett, M.A., Pickett, J.A., Wadhams, L.J., Woodcock, C.M., Prijs, H.J., Thomas, G., Trapman, J.J., Jespersen, J. & Vagn-Jensen, K.M. (1998) Control of Dipteran pests of cattle: Development of a push-pull strategy. In: *Abstracts 9th International Congress of Pesticide Chemistry, London, UK, 2-7 August, 1998*, Vol.1, 3D-021.
- Boccolini, D., Sabatini, A., Sanogo, E., Sagnon, N., Coluzzi, M. & Costantini, C. (1994) Chromosomal and vectorial heterogeneities in *Anopheles funestus* from Burkina Faso, West Africa. *Parassitologia* **36**, Supplement 1, 20.
- Bøgh, C., Pedersen, E.M., Mukoko, D.A. & Ouma, J.H. (1998) Permethrin-impregnated bednet effects on resting and feeding behaviour of lymphatic filariasis vector mosquitoes in Kenya. *Medical & Veterinary Entomology* **12**, 52-59.

- Bøgh, C., Clarke, S.E., Pinder, M., Sanyang, F. & Lindsay, S.W. (2001) Effect of passive zooprophylaxis on malaria transmission in The Gambia. *Journal of Medical Entomology* **38**, 822-828.
- Boreham, P.F. & Gill, G.S. (1973) Serological identification of reptile feeds of *Glossina*. *Acta Tropica* **30**, 356-365.
- Boreham, P.F.L. & Garrett-Jones, C. (1973) Prevalence of mixed bloodmeals and double feeding in a malaria vector (*Anopheles sacharovi* Favre). *Bulletin of the World Health Organisation* **48**, 605-614.
- Bouma, M. & Rowland, M. (1995) Failure of passive zooprophylaxis: cattle ownership in Pakistan is associated with a higher prevalence of malaria. *Transactions of the Royal Society of Tropical Medicine & Hygiene* **89**, 351-353.
- Braack, L.E.O., Coetzee, M., Hunt, R.H., Biggs, H., Cornel, A. & Gericke, A. (1994) Biting pattern and host seeking behaviour of *Anopheles arabiensis* (Diptera: Culicidae) in northeastern South Africa. *Journal of medical Entomology* **31**, 333-339.
- Brady, J., Costantini, C., Sagnon, N., Gibson, G. & Coluzzi, M. (1997) The role of body odours in the relative attractiveness of different men to malarial vectors in Burkina Faso. *Annals of Tropical Medicine & Parasitology* **91**, S121-S122.
- Braks, M. (1999) Human skin emanations in the host-seeking behaviour of the malaria mosquito *Anopheles gambiae*. *PhD Thesis*, Wageningen, The Netherlands.
- Braks, M., Cork, A. & Takken, W. (1997) Olfactometer studies on the attraction of *Anopheles gambiae sensu stricto* (Diptera: Culicidae) to human sweat. *Proceedings of the Experimental and Applied Entomology, NEV Amsterdam* **8**, 99-104.
- Braks, M.A.H. & Takken, W. (1999) Incubated human sweat but not fresh sweat attracts the malaria mosquito *Anopheles gambiae sensu stricto*. *Journal of Chemical Ecology* **25**, 663-672.
- Brouwer, R. (1960) Variations in human body odour as a cause of individual differences of attraction for malaria mosquitoes. *Tropical & Geographical Medicine* **12**, 186-192.
- Bruce-Chwatt, L.J., Garrett-Jones, C. & Weitz, B. (1966) Ten years' study (1955-64) of host selection by anopheline mosquitoes. *Bulletin of the World Health Organisation* **35**, 405-439.

- Bryan, J.H. (1979) Observations on the member species of the *Anopheles gambiae* complex in The Gambia, West Africa. *Transactions of the Royal Society of Tropical Medicine & Hygiene* **73**, 463-466.
- Bushrod, F.M. (1981) The *Anopheles gambiae* Giles complex and Bancroftian filariasis transmission in a Tanzanian coastal village. *Annals of Tropical Medicine & Parasitology* **75**, 93-100.
- Carnevale, P., Frézil, J.L., Bosseno, M.F., Le Pont, F. & Lancien, J. (1978) Etude de l'agressivité d'*Anopheles gambiae* A en fonction de l'âge et du sexe des sujets humains. *Bulletin of the World Health Organisation* **56**, 147-154.
- Catteruccia, F., Nolan, T., Loukeris, T.G., Blass, C., Savakis, C., Kafatos, F.C. & Crisanti, A. (2000) Stable germline transformation of the malaria mosquito *Anopheles stephensi*. *Nature* **405**, 959-962.
- Chand, D (1965) Malaria problem in Ethiopia. *Ethiopian Medical Journal*, **4**, 27-34.
- Charlwood, J.D., Graves, P.M. & Marshall, T.F. de C. (1988) Evidence for a 'memorised' home range in *Anopheles farauti* females from Papua New Guinea. *Medical & Veterinary Entomology* **2**, 101-108.
- Charlwood, J.D., Smith, T., Kihonda, J., Heiz, B., Billingsley, P.F. & Takken, W. (1995) Density independent feeding success of malaria vectors (Diptera: Culicidae) in Tanzania. *Bulletin of Entomological Research* **85**, 29-35.
- Clements, A. (1963) *Reproduction, The Physiology of Mosquitoes*, Pergamon Press, Oxford, p.164.
- Clements, A.N. (1999) *The biology of mosquitoes Volume 2: Sensory reception and behaviour*. CABI Publishing, CAB International, Wallingford, U.K.
- Coetzee, M. (1986) Practical use for hind-leg banding patterns for identifying members of the *Anopheles gambiae* group of mosquitoes. *Mosquito Systematics* **18**, 134-138.
- Coetzee, M. (1987) A taxonomic description of *An. quadriannulatus* Theobald (Diptera: Culicidae) from southern Africa. *Systematic Entomology* **12**, 305-312.
- Coetzee, M., Newberry, K. & Durand, D. (1982) A preliminary report on morphological character distinguishing important malaria vectors in the *Anopheles gambiae* Giles complex in South Africa. *Mosquito Systematics* **14**, 88-93.
- Coetzee, M. & Hunt, R.H. (1985) The behaviour of a particular anopheline species in Natal. *Journal of the Entomological Society of Southern Africa* **48**, 343-344.
- Coetzee, M., Hunt, R.H. & Braack, L.E.O. (1993) Enzyme variation at the aspartate aminotransferase locus in members of the *Anopheles gambiae* complex (Diptera: Culicidae). *Journal of Medical Entomology* **30**, 303-308.

- Coetzee, M., Craig, M. & Le Sueur, D. (2000) Distribution of African malaria mosquitoes belonging to the *Anopheles gambiae* complex. *Parasitology Today* **16**, 74-77.
- Collins, F.H., Finnerty, V. & Petrarca, V. (1988a) Ribosomal DNA-probes differentiate five cryptic species in the *Anopheles gambiae* complex. *Parassitologia* **30**, 231-240.
- Collins, F.H., Petrarca, V., Mpofu, S., Brandling-Bennett, A.D., Were, J.B.O., Rasmussen, M.O. & Finnerty, V. (1988b) Comparison of DNA probe and cytogenetic methods for identifying field collected *Anopheles gambiae* complex mosquitoes. *American Journal of Tropical Medicine & Hygiene* **39**, 545-550.
- Collins, F.H., Paskewitz, S.M. & Finnerty, V. (1990) Ribosomal RNA genes of the *Anopheles gambiae* species complex. *Advances in Disease Vector Research* **6**, 1-28.
- Collins, F.H., Saunders, R.D., Kafatos, F.C., Roth, C., Ke, Z., Wang, X., Dymbrowski, K., Ton, L. & Hogan, J. (1999) Genetics in the study of mosquito susceptibility to *Plasmodium*. *Parassitologia* **41**, 163-168.
- Coluzzi, M. (1984) Heterogeneities of the malaria vectorial system in tropical Africa and their significance in malaria epidemiology and control. *Bulletin of the World Health Organisation* **62**, 107-113.
- Coluzzi, M. (1989) Anopheline Mosquitoes: Genetic methods for species differentiation. In *Malaria, principles and practice of malariology*. Eds. Wernslafer, W.H. and Mc Gregor, Sir. I. Vol I, 411-430.
- Coluzzi, M. & Sabatini, A. (1968) Cytogenetic observations on species C of the *Anopheles gambiae* complex. *Parassitologia* **10**, 155-165.
- Coluzzi, M., Sabatini, A. & Petrarca, V. (1975) Chromosomal investigations on species A and B of the *Anopheles gambiae* complex in the Garki district (Kano State, Nigeria): Results of species identifications from 1971 to 1974. World Health Organization Technical note no. 24, MPD/TN/75.1, pp. 16-25.
- Coluzzi, M., Sabatini, A., Petrarca, V. & DiDeco, M.A. (1977) Behavioural divergences between mosquitoes with different inversion karyotypes in polymorphic populations of the *Anopheles gambiae* complex. *Nature* **266**, 832-833.
- Coluzzi, M., Sabatini, A., Petrarca, V. & DiDeco, M.A. (1979) Chromosomal differentiation and adaptation to human environments in the *Anopheles gambiae* complex. *Transactions of the Royal Society of Tropical Medicine and Hygiene* **73**, 483-497.

- Cork, A. (1996) Olfactory basis of host location by mosquitoes and other haematophagous Diptera. *Ciba Foundation Symposium 200 (Wiley, Chichester)*, 71-88.
- Cork, A. & Park, K.C. (1996) Identification of electrophysiologically-active compounds for the malaria mosquito, *Anopheles gambiae*, in human sweat extracts. *Medical & Veterinary Entomology* **10**, 269-276.
- Cornel, A.J., Coetzec, M., Van Rensburg, A.J., Koekemoer, L.L., Hunt, R.H. & Collins F.H. (1997) Ribosomal DNA-polymerase chain reaction assay discriminates between *Anopheles quadriannulatus* and *An. merus* (Diptera: Culicidae). *Journal of Medical Entomology* **34**, 573-577.
- Costantini, C., Gibson, G., Brady, J., Merzagora, L. & Coluzzi, M. (1993) A new odour baited trap to collect host-seeking mosquitoes. *Parassitologia* **35**, 5-9.
- Costantini, C., Gibson, G., Sagnon, N., Della Torre, A., Brady, J. & Coluzzi, M. (1996) Mosquito responses to carbon dioxide in a West African Sudan savanna village. *Medical and Veterinary Entomology* **10**, 220-227.
- Costantini, C., Sagnon, N., Della Torre, A., Diallo, M., Brady, J., Gibson, G. & Coluzzi, M. (1998) Odour-mediated host preferences of West African mosquitoes, with particular reference to malaria vectors. *American Journal of Tropical Medicine and Hygiene* **58**, 56-63.
- Costantini, C., Sagnon, N'F., Della Torre, A. & Coluzzi, M. (1999) Mosquito behavioural aspects of vector-human interactions in the *Anopheles gambiae* complex. *Parassitologia* **41**, 209-217.
- Costantini, C., Birkett, M.A., Gibson, G., Ziesmann, J., Sagnon, N'F., Mohammed, H.A., Coluzzi, M. & Pickett, J.A. (2001) Electroantennogram and behavioural responses of the malaria vector *Anopheles gambiae* to human-specific sweat components. *Medical and Veterinary Entomology* **15**, 259-266.
- Curtis, C.F. (1968) Possible use of translocations to fix desirable genes in insect populations. *Nature* **218**, 368-369.
- Curtis, C.F. (1982) The mechanism of hybrid male sterility from crosses in the *Anopheles gambiae* and *Glossina morsitans* complexes. In *Recent developments in the genetics of insect disease vectors*, W. M. Steiner, W.J. Tabachnik, K.S. Rai & S. Narang (Eds), Stipes Publishing Company, Illinois, 290-312.
- Curtis, C.F. (1994) The case for malaria control by genetic manipulation of its vectors. *Parasitology Today* **10**, 371-374.

- Curtis, C.F. & Chalkley, J. (1979) Lack of recombination between the X chromosomes of different members of the *Anopheles gambiae* complex. *Heredity* **42**, 323-326.
- Curtis, C.F., Lines, J.D., Ijumba, J., Callaghan, A. & Hill, N. (1987) The relative efficacy of repellents against mosquito vectors of disease. *Medical & Veterinary Entomology* **1**, 109-119.
- Curtis, C.F., Pates, H.V., Takken, W., Maxwell, C.A., Myamba, J., Priestman, A., Akinpelu, O., Yayo, A.M. & Jiang Ting Hu. (1999) Biological problems with the replacement of a vector population by *Plasmodium*-refractory mosquitoes. *Parassitologia* **41**, 479-481.
- Davidson, G. (1956) Insecticide resistance in *Anopheles gambiae* Giles: a case of simple mendelian inheritance. *Nature* **178**, 863-864.
- Davidson, G. (1964a) The five mating-types in the *Anopheles gambiae* complex. *Revista di Malariologia* **13**, 167-183.
- Davidson, G. (1964b) *Anopheles gambiae*, a complex of species. *Bulletin of the World Health Organisation* **31**, 625-634.
- Davidson, G. (1969) The potential use of sterile hybrid males for the eradication of member species of the *Anopheles gambiae* complex. *Bulletin of the World Health Organisation* **40**, 221-228.
- Davidson, G. & Jackson, C.E. (1962) Incipient speciation in *Anopheles gambiae* Giles. *Bulletin of the World Health Organisation* **27**, 303-305.
- Davidson, G., Paterson, H.E., Coluzzi, M., Mason, G.F. & Micks, D.W. (1967) The *Anopheles gambiae* complex. In *Genetics of Insect Vectors of Disease*, J.W. Wright & R. Pal, Amsterdam, Elsevier Publishing Company, 211-250.
- Davidson, G., Odetoyinbo, J.A., Colussa, B. & Coz, J. (1970) A field attempt to assess the mating competitiveness of sterile males produced by crossing two member species of the *Anopheles gambiae* complex. *Bulletin of the World Health Organisation* **42**, 55-67.
- Davidson, G. & Hunt, R.H. (1973) The crossing and chromosome characteristics of a new, sixth species in the *Anopheles gambiae* complex. *Parassitologia* **XV**, 121-129.
- Davis, J.R., Hall, T., Chee, E.M., Majala, A., Minjas, J. & Schiff, C.J. (1995) Comparison of sampling anopheline mosquitoes by light trap and human bait collections indoors at Bagamoyo, Tanzania. *Medical & Veterinary Entomology* **9**, 249-255.
- De Jong R. and Knols B.G.J. (1995a) Selection of biting sites on man by two malaria mosquito species. *Experientia* **51**, 80-84.

- De Jong R. and Knols B.G.J. (1995b) Olfactory responses of host-seeking *Anopheles gambiae* s.s. Giles (Diptera: Culicidae). *Acta Tropica* **59**, 333-335.
- Dekker, T. & Takken, W. (1998) Responses of *Anopheles arabiensis* Patton and *Anopheles quadriannulatus* Theobald to carbon dioxide, a man and a calf. *Medical and Veterinary Entomology* **12**, 136-140.
- Dekker, T., Takken, W., Knols B.G.J., Bouman, E., Van de Laak, S., De Bever, A. & Huisman, P.W.T. (1998) Selection of biting sites on a human host by *Anopheles gambiae* s.s., *An. arabiensis* and *An. quadriannulatus*. *Entomologia Experimentalis et Applicata* **87**, 295-300.
- Dekker, T., Takken, W. & Braks, M.A.H. (2001a) Innate preference for host odour blends modulates degree of anthropophagy within the *Anopheles gambiae* complex (Diptera: Culicidae). *Journal of Medical Entomology* **38**, 868-874.
- Dekker, T., Takken, W. & Cardé, R.T. (2001b) Structure of host-odour plumes influences upwind flight and trap catch of *Anopheles gambiae* s.s. and *Aedes aegypti*. *Physiological Entomology* **26**, 124-134.
- Della Torre, A., Merzagora, L., Powell, J.R. & Coluzzi, M. (1997) Selective introgression of paracentric inversions between two sibling species of the *Anopheles gambiae* complex. *Genetics* **146**, 239-244.
- Diatla, M., Spiegel, A., Lochouart, L. & Fontenille, D. (1998) Similar feeding preferences of *Anopheles gambiae* and *An. arabiensis* in Senegal. *Transactions of the Royal Society of Tropical Medicine and Hygiene* **92**, 270-272.
- Duchemin, J.-B., Leong Pock Tsy, J.-M., Rabarison, P., Roux, J., Coluzzi, M. & Costantini, C. (2001) Zoophily of *Anopheles arabiensis* and *An. gambiae* in Madagascar demonstrated by odour-baited entry traps. *Medical and Veterinary Entomology* **15**, 50-57.
- Edman, J.D. (1989) Are mosquitoes gourmet or gourmand? *Journal of the American Mosquito Control Association* **5**, 487-497.
- Faye, O., Konate, L., Mouchet, J., Fontenille, D., Sy, N., Hebrard, G. & Herve, J.P. (1997) Indoor resting by outdoor biting females of *Anopheles gambiae* complex (Diptera: Culicidae) in the Sahel of Northern Senegal. *Journal of Medical Entomology* **34**, 285-289.
- Feldmann, A.M., Van Gemert, G.-J., Van de Vegte-Bolmer, M.G. & Jansen, R.C. (1998) Genetics of refractoriness to *Plasmodium falciparum* in the mosquito *Anopheles stephensi*. *Medical & Veterinary Entomology* **12**, 302-312.

- Fontenille, D., Lepers, J.P., Campbell, G.H., Coluzzi, M., Rakotoarivony, I. & Coulanges, P. (1990) Malaria transmission and vector biology in Manarintsoa, High Plateaux of Madagascar. *American Journal of Tropical Medicine & Hygiene* **43**, 107-115.
- Fontenille, D., Lochouart, L., Diatta, M., Sokhna, C., Dia, I., Diagne, N., Lemasson, J.J., Ba, K., Tall, A., Rogier, C. & Trape, J.F. (1997) Four years' entomological study of the transmission of seasonal malaria in Senegal and the bionomics of *Anopheles gambiae* and *An. arabiensis*. *Transactions of the Royal Society of Tropical Medicine & Hygiene* **91**, 647-652.
- Fontenille, D. & Lochouart, L. (1999) The complexity of the malaria vectorial system in Africa. *Parassitologia* **41**, 267-271.
- Fox, A.N., Pitts, R.J., Robertson, H.E., Carlson, J. & Zwiebel, L.J. (2001) Candidate odorant receptor from the malaria vector mosquito *Anopheles gambiae* and evidence of downregulation in response to bloodfeeding. *Proceedings of the National Academy of Science, USA* **98**, 14693-14697.
- García, B.A., Caccone, A., Mathiopoulos, K.D. & Powell, J.R. (1996) Inversion monophyly in African anopheline malaria vectors. *Genetics* **143**, 1313-1320.
- Garrett-Jones, C. (1964) The human blood index of malaria vectors in relation to epidemiological assessment. *Bulletin of the World Health Organisation* **30**, 241-261.
- Garrett-Jones, C., Boreham, P.F.L. & Pant, C.P. (1980) Feeding habits of anophelines (Diptera: Culicidae) in 1971-78, with reference to the human blood index: a review. *Bulletin of Entomological Research* **70**, 165-185.
- Geier, M., Sass, H. and Boeckh, J. (1996) Search for components in human body odour that attract females of *Aedes aegypti*. *Ciba Foundation Symposium* **200**, 132-44.
- Geier, M. & Boeckh, J. (1999) A new Y-tube olfactometer for mosquitoes to measure the attractiveness of host odours. *Entomologia Experimentalis et Applicata* **92**, 9-19.
- Geier, M., Bosch, O & Boeckh, J. (1999) Ammonia as an attractive component of host odour for the yellow fever mosquito, *Aedes aegypti*. *Chemical Senses* **24**, 647-653.
- Ghebreyesus, T.A., Haile, M., Witten, K.H., Getachew, A., Yohannes, M., Lindsay, S.W. & Byass, P. (2000) Household risk factors for malaria among children in the Ethiopian highlands. *Transactions of the Royal Society of Tropical Medicine and Hygiene* **94**, 17-21.

- Gibson, G. (1995) A behavioural test of the light sensitivity of a nocturnal mosquito, *Anopheles gambiae*, to dim white light, red and infra-red light. *Physiological Entomology* **20**, 224-228.
- Gibson, G. (1996) Genetics, ecology and behaviour of anophelines. Olfaction in mosquito-host interactions. *Ciba Foundation Symposium 200 (Wiley, Chichester)*, 22-45.
- Gibson, G. & Torr, S.J. (1999) Visual and olfactory responses of haematophagous Diptera to host stimuli. *Medical & Veterinary Entomology* **13**, 2-23.
- Giglioli, G. (1963) Ecological changes as a factor in renewed malaria transmission in an eradication area. A localised outbreak of *A. aquasalis*-transmitted malaria on the Demerara river estuary, British Guyana, in the fifteenth year of *A. darlingi* and malaria eradication. *Bulletin of the World Health Organisation* **29**, 131-145.
- Gillies, M.T. (1964) Selection for host preference in *Anopheles gambiae*. *Nature* **203**, 852-854.
- Gillies, M.T. (1967) Experiments on host selection in the *Anopheles gambiae* complex. *Annals of Tropical Medicine, Hygiene and Parasitology* **61**, 68-75.
- Gillies, M.T. (1980) The role of carbon dioxide in host finding by mosquitoes (Diptera: Culicidae): a review. *Bulletin of Entomological Research* **70**, 525-532.
- Gillies, M.T. (1988) Anopheline mosquitoes: vector behaviour and bionomics. In *Malaria, principles and practice of malariology*. Eds. Wernslafer, W.H. and McGregor, Sir. I. Vol I, 453-485.
- Gillies, M.T. & Coetzee, M. (1987) A supplement to the Anophelinae of Africa South of the Sahara. *Publications of the South African Institute for Medical Research* **55**, 143pp.
- Githeko, A.K., Adungo, N.I., Karanja, D.M., Hawley, W.A., Vulule, J.M., Seroney, I.K., Ofulla, A.V.O., Atieli, F.K., Ondijo, S.O., Genga, I.O., Odada, P.K., Situbi, P.A. & Oloo, S.A. (1996) Some observations on the biting behaviour of *Anopheles gambiae s.s.*, *Anopheles arabiensis* and *Anopheles funestus* and their implications for malaria control. *Experimental Parasitology* **82**, 306-315.
- Griffiths, A.J.F., Miller, J.H., Suzuki, D.T., Lewontin, R.C. & Gelbart, W.M. (2000) *An introduction to genetic analysis, 7th Edn*. W.H. Freeman and Company, New York, USA.
- Gunasekaran, K., Jambulingam, P., Sadanandane, C., Sahu, S.S. & Das, P.K. (1994) Reliability of light trap sampling for *Anopheles fluviatilis*, a vector of malaria. *Acta Tropica* **58**, 1-11.

- Haddow, A.J. (1942) The mosquito fauna and climate of native huts at Kisumu, Kenya. *Bulletin of Entomological Research* **33**, 91-142.
- Hadis, M., Lulu, M., Makonnen, Y. & Asfaw, T. (1997) Host choice by indoor-resting *Anopheles arabiensis* in Ethiopia. *Transactions of the Royal Society of Tropical Medicine & Hygiene* **91**, 376-378.
- Hall, D.R., Beevor, P.S., Cork, A., Nesbitt, B.F. & Vale, G.A. (1984) 1-octen-3-ol: a potent olfactory stimulant and attractant for tsetse isolated from cattle odours. *Insect Science and its Application* **5**, 335-339.
- Hartl, D.L. & Clark, A.G. (1997) *Principles of population genetics*. 3rd Edition, Sinauer Associates Inc., Pub Sunderland, Massachusetts, USA.
- Hasibeder, G. & Dye, C. (1988) Population dynamics of mosquito-borne disease: persistence in a completely heterogenous environment. *Theoretical Population Biology* **33**, 31-53.
- Hewitt, S., Kamal, M., Muhammad, N. & Rowland, M. (1994) An entomological investigation of the likely impact of cattle ownership on malaria in an Afghan refugee camp in the North West Frontier Province of Pakistan. *Medical & Veterinary Entomology* **8**, 160-164.
- Hii, J.L.K. Chew, M., Sang, V.Y., Munstermann, L.E., Tan, S.G., Panyim, S. & Yasothornsrikul, S. (1991) Population genetic analysis of host seeking and resting behaviours in the malaria vector, *Anopheles balabacensis* (Diptera: Culicidae). *Journal of Medical Entomology* **28**, 675-684.
- Hill, S.M. & Crampton, J.M. (1994) Synthetic DNA probes to identify members of the *Anopheles gambiae* complex and to distinguish the two major vectors of malaria within the complex, *An. gambiae* s.s. and *An. arabiensis*. *American Journal of Tropical Medicine & Hygiene* **50**, 312-321.
- Hunt, R.H. & Mahon, R.J. (1986) Collections of *Anopheles quadriannulatus* (Diptera: Culicidae) from human habitations in southern Africa. *Journal of the Entomological Society of Southern Africa* **49**, 390-391.
- Hunt, R.H. & Gunders, A.E. (1990) The susceptibility of five laboratory colonies of mosquitoes to the human nematode *Wuchereria bancrofti* (Cobbold). *Annals of Tropical Medicine and Parasitology* **84**, 381-386.
- Hunt, R.H., Coetzee, M. & Fettene, M. (1998) The *Anopheles gambiae* complex: a new species from Ethiopia. *Transactions of the Royal Society of Tropical Medicine and Hygiene* **92**, 231-235.

- Jaenike, J. (1982) Environmental modification of oviposition behaviour in *Drosophila*. *American Naturalist* **119**, 320-325.
- Jeganathan, N. (1997) Selection of biting sites by *Anopheles gambiae* and *Anopheles atroparvus*. *MSc Thesis*, University of London.
- Jetten, T.H. & Takken, W. (1994) Anophelism without malaria in Europe: A review of the ecology and distribution of the genus *Anopheles* in Europe. *Wageningen Agricultural University Papers* **94-5**, 69 pp.
- Kamau, L., Mukabana, W.R., Hawley, W.A., Lehmann, T., Irungu, L.W., Orago, A.A.S. & Collins, F.H. (1999) Analysis of genetic variability in *Anopheles arabiensis* and *Anopheles gambiae* using microsatellite loci. *Insect Molecular Biology* **8**, 287-297.
- Kelly, D.W. (2001) Why are some people bitten more than others? *Trends in Parasitology* **17**, 578-581.
- Kenawy, M.A., Beier, J.C., Asiago, C.M. & El Said, S. (1990) Factors affecting the human-feeding behaviour of anopheline mosquitoes in Egyptian oases. *Journal of the American Mosquito Control Association* **6**, 446-451.
- Kettle, D.S. (1995) *Medical & Veterinary Entomology*, 2nd edition, CAB International, Wallingford, UK.
- Killeen, G.F., McKenzie, F.E., Foy, B.D., Bøgh, C. & Beier, J.C. (2001) The availability of potential hosts as a determinant of feeding behaviours and malaria transmission by African mosquito populations. *Transactions of the Royal Society of Tropical Medicine and Hygiene* **95**, 469-476.
- Kimwordoyo, S. & Supalin (1986) Zooprophylaxis as a useful tool for control of *A. aconitus* transmitted malaria in central Java, Indonesia. *Journal of Communicable Disease* **18**, 90-94.
- Kiszewski, A.E. & Spielman, A. (1998) Spatially explicit model of transposon-based genetic drive mechanisms for displacing fluctuating populations of Anopheline vector mosquitoes. *Journal of Medical Entomology* **35**, 584-590.
- Kline, D.L. (1994) Olfactory attractants for mosquito surveillance and control: 1-octen-3-ol. *Journal of the American Mosquito Control Association* **10**, 280-287.
- Kline, D.L., Wood, J.R. & Cornell, J.A. (1991) Interactive effects of 1-octen-3-ol and carbon dioxide on mosquito (Diptera: Culicidae) surveillance and control. *Journal of Medical Entomology* **28**, 254-258.

- Klowden, M.J. & Lea, A.O. (1978) Blood meal size as a factor affecting continued host-seeking by *Aedes aegypti* (L.). *American Journal of Tropical Medicine and Hygiene* **27** (4), 827-831.
- Knols, B.G.J. (1996) Odour-mediated host-seeking behaviour of the Afro-tropical malaria vector *Anopheles gambiae* Giles. *PhD Thesis*, Wageningen, The Netherlands.
- Knols, B.G.J., De Jong, R. & Takken, W. (1994) Trapping system for testing olfactory responses of the malaria mosquito *Anopheles gambiae* in a wind tunnel. *Medical and Veterinary Entomology* **8**, 386-388.
- Knols, B.G.J., De Jong, R. & Takken, W. (1995a) Differential attractiveness of isolated humans to mosquitoes in Tanzania. *Transactions of the Royal Society of Tropical Medicine and Hygiene* **89**, 604-606.
- Knols, B.G.J., Takken, W., Charlwood, D. & De Jong, R. (1995b) Species-specific attraction of *Anopheles* mosquitoes (Diptera: Culicidae) to different humans in south-east Tanzania. *Proceedings of the Experimental and Applied Entomology, NEV Amsterdam* **6**, 201-206.
- Knols, B.G.J. & De Jong, R. (1996) Limburger cheese as an attractant for the malaria mosquito *Anopheles gambiae* s.s. *Parasitology Today* **12**, 159-161.
- Knols, B.G.J., Van Loon, J.J.A., Cork, A., Robinson, R.D., Adam, W., Meijerink, J., De Jong, R. & Takken, W. (1997) Behavioural and electrophysiological responses of the female malaria mosquito *Anopheles gambiae* s.s. (Diptera: Culicidae) to Limburger cheese volatiles. *Bulletin of Entomological Research* **87**, 151-159.
- Krafsur, E.S. (1977) The bionomics and relative prevalence of *Anopheles* species with respect to the transmission of *Plasmodium* to man in Western Ethiopia. *Journal of Medical Entomology* **14**, 180-194.
- Kristan, M., Oyeneye, R., Biersack, G. & Amajoh, C. (2002) Pyrethroid resistance in *Anopheles gambiae* s.l. in Ogun State, Nigeria. *Transactions of the Royal Society of Tropical Medicine and Hygiene*, in press.
- Laarman, J.J. (1955) The host-seeking behaviour of the malaria mosquito. *PhD Thesis*, Leiden, The Netherlands.
- Laarman, J.J. (1958) The host-seeking behaviour of Anopheline mosquitoes. *Tropical Geographical Medicine* **10**, 293-305.
- Lanzaro, G.C., Touré, Y.T., Carnahan, J., Zheng, L., Dolo, G., Traoré, S., Petrarca, V., Vernick, K.D. & Taylor, C.E. (1998) Complexities in the genetic structure of *Anopheles gambiae* populations in west Africa as revealed by microsatellite DNA analysis. *Proceedings of the National Academy of Science, USA* **95**, 14260-14265.

- Lemasson, J.J., Fontenille, D., Lochouarn, L., Dia, I., Simard, F., Diop, A., Diatta, M. & Molez, J.F. (1997) Comparison of behaviour and vector efficiency of *Anopheles gambiae* and *An. arabiensis* (Diptera: Culicidae) in Barkedji, a Sahelian area of Senegal. *Journal of Medical Entomology* **34**, 396-403.
- Li, Z. & Lu, B. (1990) Field trials and use of pyrethroid-treated mosquito nets for malaria control in China. In *Appropriate Technology in Vector Control*, Ed. C.F. Curtis, CRC Press Inc, Florida, 33-38.
- Lindsay, S.W., Adiamah, H., Miller, J.E., Pleass, R.J. & Armstrong, J.R.M. (1993) Variation in attractiveness of human subjects to malaria mosquitoes (Diptera: Culicidae) in the Gambia. *Journal of Medical Entomology* **30**, 368-373.
- Lindsay, S.W., Parson, L. & Thomas, C.J. (1998) Mapping the ranges and relative abundance of the two principal African malaria vectors, *Anopheles gambiae sensu stricto* and *Anopheles arabiensis*, using climate data. *Proceedings of the Royal Society London B* **265**, 847-854.
- Lindsay, S., Ansell, J., Selman, C., Cox, V., Hamilton, K. & Walraven, G. (2000) Effect of pregnancy on exposure to malaria mosquitoes. *The Lancet* **355**, 1972.
- Lines, J.D., Lyimo, E.O. & Curtis, C.F. (1986) Mixing of indoor- and outdoor-resting adults of *Anopheles gambiae* Giles *s.l.* and *A. funestus* Giles (Diptera: Culicidae) in coastal Tanzania. *Bulletin of Entomological Research* **76**, 171-178.
- Lines, J.D., Curtis, C.F., Wilkes, T.J. & Njunwa, K.J. (1991) Monitoring human-biting mosquitoes (Diptera: Culicidae) in Tanzania with light-traps hung beside mosquito nets. *Bulletin of Entomological Research* **81**, 77-84.
- Lochouarn, L., Dia, I., Boccolini, D., Coluzzi, M. & Fontenille, D. (1998) Bionomical and cytogenetic heterogeneities of *Anopheles funestus* in Senegal. *Transactions of the Royal Society of Tropical Medicine and Hygiene* **92**, 607-612.
- Lochouarn, L. & Fontenille, D. (1999) ELISA detection of malaria sporozoites: false-positive results in *Anopheles gambiae s.l.* associated with bovine bloodmeals. *Transactions of the Royal Society of Tropical Medicine and Hygiene* **93**, 101-102.
- Lulu, M., Nigatu, W., Gezahegn, T. & Tilahun, D. (1991) Inversion polymorphisms in *Anopheles arabiensis* (Patton) in five selected localities from east, south and southwest Ethiopia. *Insect Science and its Application* **12**, 375-378.
- Magesa, S.M., Wilkes, T.J., Mnzava, A.E.P., Njunwa, K.J., Myamba, J., Kivuyo, M.D.P., Hill, N., Lines, J.D. & Curtis, C.F. (1991) Trial of pyrethroid impregnated bednets in an area of Tanzania holoendemic for malaria Part 2. Effects on the malaria vector population. *Acta Tropica* **49**, 97-108.

- Mathenge, E.M., Killeen, G.F., Oulo, D.O., Irungu, L.W., Ndegwa, P.N. & Knols, B.G.J. (2002) Development of an exposure-free bednet trap for sampling Afrotropical malaria vectors. *Medical & Veterinary Entomology* **16**, 67-74.
- Maxwell, C.A., Myamba, J., Njunwa, K.J., Greenwood, B.M. and Curtis, C.F. (1999) Comparison of bednets impregnated with different pyrethroids for their impact on mosquitoes and on re-infection with malaria after clearance of pre-existing infections with chlorproguanil-dapsone. *Transactions of the Royal Society of Tropical Medicine and Hygiene* **93**, 4-11.
- Mayer, M.S. & James, J.D. (1969) Attraction of *Aedes aegypti* (L): responses to human arms, carbon dioxide, and air currents in a new type of olfactometer. *Bulletin of Entomological Research* **58**, 629-642.
- Mboera, L.E.G. & Takken, W. (1997) Carbon dioxide chemotropism in mosquitoes (Diptera: Culicidae) and its potential in vector surveillance and management programmes. *Review of Medical and Veterinary Entomology* **85**, 355-368.
- Mboera, L.E.G., Knols, B.G.J., Takken, W. & Della Torre, A. (1997) The response of *Anopheles gambiae s.l.* and *An. funestus* (Diptera: Culicidae) to tents baited with human odour or carbon dioxide in Tanzania. *Bulletin of Entomological Research* **87**, 173-178.
- Mboera, L.E.G., Kihonda, J., Braks, M.A.H. & Knols, B.G.J. (1998a) Influence of Centers for Disease Control light trap position, relative to a human baited bed net, on catches of *Anopheles gambiae* and *Culex quinquefasciatus* in Tanzania. *American Journal of Tropical Medicine & Hygiene* **59**, 595-596.
- Mboera, L.E., Knols, B.G., Takken, W. & Huisman, P.W. (1998b) Olfactory responses of female *Culex quinquefasciatus* Say (Diptera: Culicidae) in a dual choice olfactometer. *Journal of Vector Ecology* **23**, 107-113.
- Mbogo, C.M., Kabiru, E.W., Muivuri, S.K., Nzovu, J.M., Ouma, J.H., Githure, J.I. & Beier, J.C. (1993) Bloodfeeding behaviour of *Anopheles gambiae s.l.* and *Anopheles funestus* in Kilifi district, Kenya. *Journal of the American Mosquito Control Association* **9**, 225-227.
- McCall, P.J. & Eaton, G. (2001) Olfactory memory in the mosquito *Culex quinquefasciatus*. *Medical & Veterinary Entomology* **15**, 197-203.
- McCall, P.J., Mosha, F.W., Njunwa, K.J. & Sherlock, K. (2001) Evidence for memorized site-fidelity in *Anopheles arabiensis*. *Transactions of the Royal Society of Tropical Medicine and Hygiene* **95**, 587-590.

- Mekuria, M., Petrarca, V. & Tesfamarian, T. (1982) Cytogenetic studies on the malaria vector mosquito *Anopheles arabiensis* Patton in the Awash Valley, Ethiopia. *Parassitologia* **24**, 237-243.
- Miles, S.J. (1979) A biochemical key to adult members of the *Anopheles gambiae* group of species (Diptera: Culicidae). *Journal of Medical Entomology* **15**, 297-299.
- Mnzava, A.E.P., Mutinga, M.J. & Staak, C. (1994) Host bloodmeals and chromosomal inversion polymorphism in *Anopheles arabiensis* in the Baringo district of Kenya. *Journal of the American Mosquito Control Association* **10**, 507-510.
- Mnzava, A.E.P., Rwegoshora, R.T., Wilkes, T.J., Tanner, M. & Curtis, C.F. (1995) *Anopheles arabiensis* and *An. gambiae* chromosomal inversion polymorphism, feeding and resting behaviour in relation to insecticide house-spraying in Tanzania. *Medical & Veterinary Entomology* **9**, 316-324.
- Molineaux, L. & Gramiccia, G. (1980) The Garki Project: research on the epidemiology and control of malaria in the Sudan savanna of West Africa. *World Health Organisation, Geneva*.
- Mpofu, S.M. & Masendu, H.T. (1986) Description of a baited trap for sampling mosquitoes. *Journal of the American Mosquito Control Association* **2**, 363-365.
- Mpofu, S.M., Masendu, H.T., Kanyimo, K.H. & Mtetwa, C. (1993) Laboratory colonization of *Anopheles quadriannulatus* from sympatry with other sibling species of the *Anopheles gambiae* complex in Zimbabwe. *Medical & Veterinary Entomology*, **7**, 122-126.
- Muirhead-Thomson, R.C. (1948) Studies on *Anopheles gambiae* and *An. melas* in and around Lagos. *Bulletin of Entomological Research* **38**, 527-558.
- Muirhead-Thomson, R.C. (1951) The distribution of anopheline mosquito bites among different age groups. *British Medical Journal* **i**, 1114-1117.
- Mukwaya, L.G. (1974) Host preference in *Aedes simpsoni* (Theo.) (Diptera: Culicidae) with special reference to the anthropophilic and non-anthropophilic forms in Uganda. *Bulletin of Entomological Research* **64**, 129-139.
- Mukwaya, L.G. (1976) The role of olfaction in host preference by *Aedes (Stegomyia) simpsoni* and *Ae. aegypti*. *Physiological Entomology* **1**, 271-276.
- Mukwaya, L.G. (1977) Genetic control of feeding preferences in the mosquitoes *Aedes (Stegomyia) simpsoni* and *aegypti*. *Physiological Entomology* **2**, 133-145.
- Mukwaya, L.G., Kayondo, J.K., Crabtree, M.B., Savage, H.M., Biggerstaff, B.J. & Miller, B.R. (2000) Genetic differentiation in the yellow fever virus vector, *Aedes simpsoni* complex, in Africa: Sequence variation in the ribosomal DNA internal

- transcribed spacers of anthropophilic and non-anthropophilic populations. *Insect Molecular Biology* **9**, 85-91.
- Munstermann, L.E. (1994) Unexpected genetic consequences of colonisation and inbreeding: allozyme tracking in Culicidae (Diptera). *Annals of the Entomological Society of America* **87**, 157-164.
- Mwandawiro, C., Boots, M., Tuno, N., Suwonkerd, W., Tsuda, Y. & Takagi, M. (2000) Heterogeneity in the host preference of Japanese encephalitis vectors in Chiang Mai, northern Thailand. *Transactions of the Royal Society of Tropical Medicine and Hygiene* **94**, 238-242.
- Nanda, N., Joshi, H., Subbarao, S.K., Yadav, R.S., Shikla, R.P., Dua, V.K. & Sharma, V.P. (1996) *Anopheles fluviatilis* complex: host feeding patterns of species S, T and U. *Journal of the American Mosquito Control Association* **12**, 115-117.
- Nigatu, W., Petros, B., Lulu, M., Adugna, N. & Wirtz, R. (1994) Species composition, feeding and resting behaviour of the common anthropophilic Anopheline mosquitoes in relation to malaria transmission in Gambella, South West Ethiopia. *Insect Science and its Application* **15**, 371-377.
- Norris, D. E., Shurtleff, A.C., Touré, Y.T. & Lanzaro, G.C. (2001) Microsatellite DNA polymorphism and heterozygosity among field and laboratory populations of *Anopheles gambiae* s.s. (Diptera: Culicidae). *Journal of Medical Entomology* **38**, 336-340.
- O'Conner, C.T. (1967) The distribution of anopheline mosquitoes in Ethiopia. *Mosquito News* **27**, 42-54.
- Odetoyinbo, J.A. & Davidson, G. (1968) The *Anopheles gambiae* complex and its role in the malaria transmission in the islands of Zanzibar and Pemba, United Republic of Tanzania. *WHO/Mal/68.660, WHO/VBC/68.89*, 7pp.
- Paterson, H.E., Paterson, J.S. & Van Eeden, G.J. (1963) A new member of the *Anopheles gambiae* complex. *Medical Proceedings: Mediese Bydraes* **9**, 414-418.
- Petrarca, V., Beier, J.C., Onyango, F., Koros, J., Asiago, C., Koech, D.K. & Roberts, C.R. (1991) Species composition of the *Anopheles gambiae* complex (Diptera: Culicidae) at two sites in Western Kenya. *Journal of Medical Entomology* **28**, 307-313.
- Petrarca, V. & Beier, J.C. (1992) Intraspecific chromosomal polymorphism in the *Anopheles gambiae* complex as a factor affecting malaria transmission in the Kisumu area of Kenya. *American Journal of Tropical Medicine & Hygiene* **46**, 229-237.

- Port, G.R., Boreham, P.F.L. & Bryan, J.H. (1980) The relationship of host size to feeding by mosquitoes of the *Anopheles gambiae* Giles complex (Diptera: Culicidae). *Bulletin of Entomological Research* **70**, 133-144.
- Ralisoa Randrianasolo, B.O. & Coluzzi, M. (1987) Genetical investigations on zoophilic and exophilic *Anopheles arabiensis* from Antananarivo area (Madagascar). *Parassitologia* **29**, 93-97.
- Rawlings, P. & Curtis, C.F. (1982) Tests for the existence of genetic variability in the tendency of *Anopheles culicifacies* species B to rest in houses and to bite man. *Bulletin of the World Health Organisation* **60**, 427-432.
- Reisen, W.K. & Boreham, P.F.L. (1979) Host selection patterns of some Pakistan mosquitoes. *American Journal of Tropical Medicine & Hygiene* **28**, 408-421.
- Ribbands C.R. (1944) Differences between *Anopheles melas* (*A. gambiae* var. *melas*) and *Anopheles gambiae*, I. The larval pecten. *Annals of Tropical Medicine & Parasitology* **38**, 85-86.
- Ribeiro, J.M.C., Seulu, F., Abose, T., Kidane, G. & Teklehaimanot, A. (1996) Temporal and spatial distribution of anopheline mosquitoes in an Ethiopian village: implications for malaria control strategies. *Bulletin of the World Health Organisation* **74**, 299-305.
- Rowland, M., Durrani, N., Kenward, M., Mohammed, N., Urahman, H. & Hewitt, S. (2001) Control of malaria in Pakistan by applying deltamethrin insecticide to cattle: a community randomised trial. *The Lancet* **357**, 1837-1841.
- Rubio-Palis, Y. (1992) Influence of moonlight on light trap catches of the malaria vector *Anopheles nunetzovari* in Venezuela. *Journal of the American Mosquito Control Association* **8**, 178-180.
- Schultz, G.W. (1989) Animal influence on man-biting rates at a malarious site in Palawan, Philippines. *South East Asian Journal of Tropical Medicine and Public Health* **20**, 49-53.
- Scott J.A., Brogdon W.G. and Collins F.H. (1993) Identification of single specimens of the *Anopheles gambiae* complex by the polymerase chain reaction. *American Journal of Tropical Medicine & Hygiene* **49**, 520-529.
- Service, M.W. (1993) Mosquito Ecology: field sampling methods. 2nd Edn. *Elsevier Science Publishers Ltd., Barking, Essex, U.K.*
- Severson, D.W., Thathy, V., Mori, A., Zhang, Y. & Christensen, B.M. (1995) Restriction fragment length polymorphism mapping of quantitative trait loci for malaria parasite susceptibility in the mosquito *Aedes aegypti*. *Genetics* **139**, 1711-1717.

- Sharp, B.L., Quicke, F.C. & Jansen, E.J. (1984) Aspects of the behaviour of five anopheline species in the endemic malaria area of Natal. *Journal of the Entomological Society of Southern Africa* **47**, 251-258.
- Sharp, B.L. & Le Sueur, D. (1991) Behavioural variation of *Anopheles arabiensis* (Diptera: Culicidae) populations in Natal, South Africa. *Bulletin of Entomological Research* **81**, 107-110.
- Smith, C.N., Smith, N., Gouck, H.K., Weidhaas, D.E., Gilbert, I.H., Mayer, M.S., Smittle, B.J. & Hofbauer, A. (1970) L-lactic acid as a factor in the attraction of *Aedes aegypti* (Diptera: Culicidae) to human hosts. *Annals of the Entomological Society of America* **63**, 760-770.
- Snow, R.W., Peshu, N., Forster, D., Bomu, G., Mitsanze, E., Ngumbao, E., Chisengwa, R., Armstrong-Schellenberg, J.R.M., Hayes, R.J., Newbold, C.I. & Marsh, K. (1998) Environmental and entomological risk factors for the development of clinical malaria among children on the Kenyan coast. *Transactions of the Royal Society of Tropical Medicine and Hygiene* **92**, 381-385.
- Snow, W.F. (1983) The attractiveness of some birds and mammals for mosquitoes in the Gambia, West Africa. *Annals of Tropical Medicine & Parasitology* **77**, 641-651.
- Snow, W.F. (1987) Studies of house-entering habits of mosquitoes in The Gambia, West Africa: experiments with prefabricated huts with varied wall apertures. *Medical & Veterinary Entomology* **1**, 9-21.
- Sota, T. & Mogi, M. (1989) Effectiveness of zooprophylaxis in malaria control: a theoretical inquiry, with a model for mosquito populations with two bloodmeal hosts. *Medical & Veterinary Entomology* **3**, 337-345.
- Spielman, A. (1994) Why entomological research should not focus on transgenic mosquitoes. *Parasitology Today* **10**, 374-376.
- Subbarao, S.K., Vasantha, K., Joshi, H., Raghavendra, K., Usha Devi, C., Sathyanarayan, T.S., Cochrane, A.H., Nussenzweig, R.S. & Sharma, V.P. (1992) Role of *Anopheles culicifacies* sibling species in malaria transmission in Madhya Pradesh State, India. *Transactions of the Royal Society of Tropical Medicine and Hygiene* **86**, 613-614.
- Subbarao, S.K., Nanda, N. & Raghavendra, K. (1999) Malariogenic stratification of India using *Anopheles culicifacies* sibling species prevalence. *ICMR Bulletin* **29**, 7pp.
- Sunnocks, P. & Hales, D.F. (1996) Numerous transposed sequences of mitochondrial cytochrome-oxidase I-II in aphids of the genus *Sitobion* (Hemiptera, aphididae). *Molecular Biology & Evolution* **13**, 510-524.

- Surendran, S.N., Abhayawardana, T.A., De Silva, B.G.D.N.K., Ramasamy, R. & Ramasamy, M.S. (2000) *Anopheles culicifacies* Y-chromosome dimorphism indicates sibling species (B + E) with different malaria vector potential in Sri Lanka. *Medical & Veterinary Entomology* **14**, 437-440.
- Sutcliffe, J.F. (1987) Distance orientation of biting flies to their hosts. *Insect Science and its Application* **8**, 611-616.
- Takken, W. (1991) The role of olfaction in host-seeking of mosquitoes: A review. *Insect Science and its Application* **12**, 287-295.
- Takken, W. (1996) Synthesis and future challenges: the response of mosquitoes to host odours. *Ciba Foundation Symposium 200 (Wiley, Chichester)*, 302-320.
- Takken, W. & Kline, D.L. (1989) Carbon dioxide and 1-octen-3-ol as mosquito attractants. *Journal of the American Mosquito Control Association* **5**, 311-316.
- Takken, W. & Knols, B.G.J. (1990) Flight behaviour of *Anopheles gambiae* Giles (Diptera: Culicidae) in response to host stimuli: A windtunnel study. *Proceedings of the Experimental and Applied Entomology, NEV Amsterdam* **1**, 121-128.
- Takken W., Dekker T. and Wijnholds Y. (1997) Odour-mediated behaviour of *Anopheles gambiae* s.s. Giles and *An. stephensi* Liston in response to CO₂, acetone, and 1-octene-3-ol. *Journal of Insect Behaviour* **10**, 395-407.
- Takken, W. & Knols, B.G.J. (1999) Odour-mediated behavior of Afrotropical malaria mosquitoes. *Annual Review of Entomology* **44**, 131-157.
- Takken, W., Eling, W., Hooghof, J., Dekker, T., Hunt, R. & Coetzee, M. (1999) Susceptibility of *Anopheles quadriannulatus* Theobald (Diptera: Culicidae) to *Plasmodium falciparum*. *Transactions of the Royal Society of Tropical Medicine and Hygiene* **93**, 578-580.
- Takken, W., Loon, J.J.A. van. & Adam, W. (2001) Inhibition of host-seeking response and olfactory responsiveness in *Anopheles gambiae* following blood feeding. *Journal of Insect Physiology* **47**, 303-310.
- Takken, W., Stuke, K. & Klowden, M.J. (2002) Biological differences in reproductive strategy between the mosquito sibling species *Anopheles gambiae sensu stricto* and *An. quadriannulatus*. *Entomologia Experimentalis et Applicata*. In press.
- Thomas, T.C.E. (1951) Biting activity of *Anopheles gambiae*. *British Medical Journal* **ii**, 1402.
- Torr, S.J., Wilson, P.J., Schofield, S., Mangwiro, T.N.C., Akber, S. & White, B.N. (2001) Application of DNA markers to identify the individual specific hosts of tsetse feeding on cattle. *Medical & Veterinary Entomology* **15**, 78-86.

- Turner, R.L. (1972) Malaria epidemiological observations from unsprayed study districts in Ethiopia. *Mosquito News* **32**, 608-613.
- Vale, G.A. (1974) The responses of tsetse flies (Diptera, Glossinidae) to mobile and stationary baits. *Bulletin of Entomological Research* **64**, 545-588.
- Vale, G.A. (1977) Feeding responses of tsetse flies (Diptera, Glossinidae) to stationary hosts. *Bulletin of Entomological Research* **67**, 635-649.
- Vale, G.A. (1993) Development of baits for tsetse flies (Diptera: Glossinidae) in Zimbabwe). *Journal of Medical Entomology* **30**, 831-842.
- Vale, G.A. & Cumming, D.H.M. (1976) The effects of selective elimination of hosts on a population of tsetse flies *Glossina morsitans morsitans* Westwood (Diptera, Glossinidae). *Bulletin of Entomological Research* **66**, 713-729.
- Van Emden, H.F., Sponagl, B., Wagner, E., Baker, T., Ganguly, S. & Douloumpaka, S. (1996) Hopkins' 'host selection principle', another nail in its coffin. *Physiological Entomology* **21**, 325-328.
- Van Essen, P.H.A., Kemme, J.A. & Ritchie, S.A. (1994) Differential responses of *Aedes* and *Culex* mosquitoes to octenol or light in combination with carbon dioxide in Queensland, Australia. *Medical & Veterinary Entomology* **8**, 63-67.
- Van den Hurk, A.F., Beebe, N.W. & Ritchie, S.A. (1997) Responses of mosquitoes of the *Anopheles farauti* complex to 1-octen-3-ol and light in combination with carbon dioxide in northern Queensland, Australia. *Medical and Veterinary Entomology* **11**, 177-180.
- Van Rensburg, A.J., Hunt, R.H., Koekemoer, L.L., Coetzee, M., Shiff, C.J. & Minjas, J. (1996) The Polymerase chain reaction method as a tool for identifying members of the *Anopheles gambiae* complex (Diptera: Culicidae) in north-eastern Tanzania. *Journal of the American Mosquito Control Association* **12**, 271-274.
- Van Thiel, P.H., Reuter, J., Sautet, J. & Bever, L. (1939) On zoophilism and anthropophilism of *Anopheles* biotypes and species. *Revista di Malariologia* **18**, 95-124.
- Vaughan, J.A., Noden, B.H. & Beier, J.C. (1991) Concentration of human erythrocytes by anopheline mosquitoes (Diptera: Culicidae) during feeding. *Journal of Medical Entomology* **28**, 780-786.
- Vernick, K.D., Fujioka, H., Seeley, D.C., Tandler, B., Aikawa, M. & Miller, L.H. (1995) *Plasmodium gallinaceum*: a refractory mechanism of ookinete killing in the mosquito *Anopheles gambiae*. *Experimental Parasitology* **80**, 583-595.

- Walton, C., Thelwell, N.J., Priestman, A. & Butlin, R.K. (1998) The use of microsatellites to study gene flow in natural populations of *Anopheles* malaria vectors in Africa: potential and pitfalls. *Journal of the American Mosquito Control Association* **14**, 266-272.
- Wang, R., Zheng, L., Touré, Y.T., Dandekar, T. & Kafatos, F.C. (2001) When genetic distance matters: measuring genetic differentiation at microsatellite loci in whole-genome scans of recent and incipient mosquito species. *Proceedings of the National Academy of Science, USA* **98**, 10769-10774.
- White, G.B. (1971) Chromosomal evidence for natural interspecific hybridisation by mosquitoes of the *Anopheles gambiae* complex. *Nature* **231**, 184-185.
- White, G.B. (1974a) *Anopheles gambiae* complex and disease transmission in Africa. *Transactions of the Royal Society of Tropical Medicine and Hygiene* **68**, 278-301.
- White, G.B. (1974b) Biological effects of intraspecific chromosomal polymorphism in malaria vector populations. *Bulletin of the World Health Organisation* **50**, 299-306.
- White, G.B. (1980) Academic and applied aspects of mosquito cytogenetics. In *Insect Cytogenetics, RES Symposium 10*, Eds. R.L. Blackman, G.M. Hewitt & M. Ashburner, Blackwell Scientific Publications, London, 245-274.
- White, G.B. (1982) Malaria vector ecology and genetics. *British Medical Bulletin* **38**, 207-212.
- White, G.B., Magayuka, S.A. & Boreham, P.F.L. (1972) Comparative studies on sibling species of the *Anopheles gambiae* Giles complex (Dipt., Culicidae): bionomics and vectorial activity of species A and species B at Segera, Tanzania. *Bulletin of Entomological Research* **62**, 295-317.
- White, G.B. & Rosen, P. (1973) Comparative studies on sibling species of the *Anopheles gambiae* Giles complex (Dipt., Culicidae). II. Ecology of species A and B in savanna around Kaduna, Nigeria, during transition from wet to dry season. *Bulletin of Entomological Research* **62**, 613-625.
- White, G.B., Tessfaye, F., Boreham, P.F.L. & Lemma, G. (1980) Malaria capacity of *Anopheles arabiensis* and *An. quadriannulatus* in Ethiopia: chromosomal interpretation after 6 years storage of field preparations. *Transactions of the Royal Society of Tropical Medicine and Hygiene* **74**, 683-684.
- Wilkes, T.J., Myamba, J. & Curtis, C.F. (1995) Indoor, human-biting anopheline populations at high and low altitude sites in Tanzania. *Transactions of the Royal Society of Tropical Medicine and Hygiene* **89**, 246.

- Wilkes, T.J., Matola, Y.G. & Charlwood, J.D. (1996) *Anopheles rivulorum*, a vector of human malaria in Africa. *Medical & Veterinary Entomology* **10**, 108-110.
- Willemse, L.P.M. & Takken, W. (1994) Odour-induced host location in tsetse flies (Diptera: Glossinidae). *Journal of Medical Entomology* **31**, 775-794.
- Willis, E.R. (1948) The olfactory responses of female mosquitoes. *Journal of Economic Entomology* **40**, 769-778.
- Wirtz, R.A., Burkot, T.R., Graves, P. M. & Andre, R.G. (1987) Field evaluation of enzyme-linked immunosorbent assays for *Plasmodium falciparum* and *Plasmodium vivax* sporozoites in mosquitoes from Papua New Guinea. *Journal of Medical Entomology*, **24**, 433-437.
- Wright, S. (1921) Systems of mating. *Genetics* **6**, 111-178.
- Wright, S. (1978) *Evolution and the genetics of populations. Vol 4, variability within and among natural populations*. University Press of Chicago, Chicago, USA.
- Zheng, L., Benedict, M.Q., Cornel, A.J., Collins, F.H. & Kafatos, F.C. (1996) An integrated genetic map of the African human malaria vector mosquito, *Anopheles gambiae*. *Genetics* **143**, 941-952.

Appendix I

SUMMARY OF MICROSATELLITE ANALYSIS OF THREE *AN. QUADRIANNULATUS* COLONIES

This work was carried out by Dr. Steven Sinkins in the University of Notre Dame, USA. Three separate *Anopheles quadriannulatus* SKUQUA strain colonies from Notre Dame, Wageningen and South Africa were compared with *Anopheles gambiae s.s.* SUA strain using a variety of primers. The colony from Wageningen originated from material from the South African colony. The Notre Dame colony was started with material from the Wageningen colony in January 1998 and regular egg batches were sent from Wageningen to boost the colony until October 1998.

Primers 26, 59, 127, 187, 197 and 757 were assayed and showed some overlap in the allele size range between the SUA and SKUQUA (Notre Dame) colonies. Primers 802 and 131 showed the same allele sizes in the SKUQUA (Wageningen) and SKUQUA (Notre Dame) colonies; allele sizes for these primers in the SUA colony were completely different. Primer 131 was the only X-linked primer tested; all other primers were autosomal. Primers 46, 53, 175, 290, 590, 776 and 799 were also assayed and showed separate non-overlapping allele sizes in the SKUQUA (Notre Dame) material from January 1998 and SUA colonies. Data for the SKUQUA (Wageningen) colony showed a mixture of two allele sizes and data for the SKUQUA (South Africa) colony showed similar allele sizes to that found with the material from the SKUQUA (Notre Dame) colony from January 1999. Data for material from the SKUQUA (Notre Dame) colony from March 1999 showed overlapping allele sizes with the SUA samples tested. Data for primer 46 is shown in table I.

Conclusions

These results are indicative of either contamination or of extensive bottlenecking in the Notre Dame and South African colonies (compared to the Wageningen colony), so that a number of rare alleles were lost in the Notre Dame and South African colonies. However this conclusion is only applicable to certain primers tested since not all were informative and primer 802 showed no overlapping allele sizes between the Notre Dame and Wageningen colonies and the SUA colony.

Appendix I (continued)

Table I: Allele size (estimated base pairs) for three *An. quadriannulatus* colonies and an *An. gambiae s.s.* colony tested with primer 46. Each row represents data for one mosquito including the date that individual was removed from the colony. Individuals showing one peak are homozygotes whereas individuals with two peaks are heterozygotes.

Colony (origin) & (date)	Peak 1	Peak 2
SKUQUA (Notre Dame) (01/98)	161.6	
SKUQUA (Notre Dame) (01/98)	161.67	
SKUQUA (Notre Dame) (01/98)	161.78	
SKUQUA (Notre Dame) (01/98)	161.66	
SKUQUA (Notre Dame) (01/98)	161.55	
SKUQUA (Wageningen) (03/99)	161.77	171.94
SKUQUA (Wageningen) (03/99)	161.77	
SKUQUA (Wageningen) (03/99)	161.73	
SKUQUA (Wageningen) (03/99)	161.73	
SKUQUA (Wageningen) (03/99)	161.73	171.89
SKUQUA (Wageningen) (03/99)	161.74	
SKUQUA (Notre Dame) (03/99)	163.59	171.85
SKUQUA (Notre Dame) (03/99)	161.55	172.04
SKUQUA (Notre Dame) (03/99)	161.46	171.95
SKUQUA (South Africa) (03/99)	161.59	
SKUQUA (South Africa) (03/99)	161.56	
SKUQUA (South Africa) (03/99)	161.63	
SKUQUA (South Africa) (03/99)	161.63	
SKUQUA (South Africa) (03/99)	161.52	
SUA (date unknown)		172.03*
SUA (date unknown)		171.97*
SUA (date unknown)		171.99*
SUA (date unknown)		172.03*
SUA (date unknown)		172.01*
SUA (date unknown)		172.13*
SUA (date unknown)		171.99*

* Walton *et al.* (1998) and C. Roper (personal communication) report allele sizes of between 136 and 148bp for locus 46.

Appendix II

GEL PHOTOGRAPHS FROM PCR ANALYSIS OF *AN. GAMBIAE S.L.*

The following figures are examples of gel photographs taken after PCR analysis of *An. gambiae s.l.* mosquitoes using the method of Scott *et al.* (1993), described in section 2.6. The number of the well where the PCR product was loaded has been labelled and the contents and its origin are show in the table below the photograph. Mosquitoes showing weak bands were retested to verify the identification. Positive control specimens were taken from mosquito colonies and water was used as a negative control.

Figure IIa Gel 1: miscellaneous mosquito samples

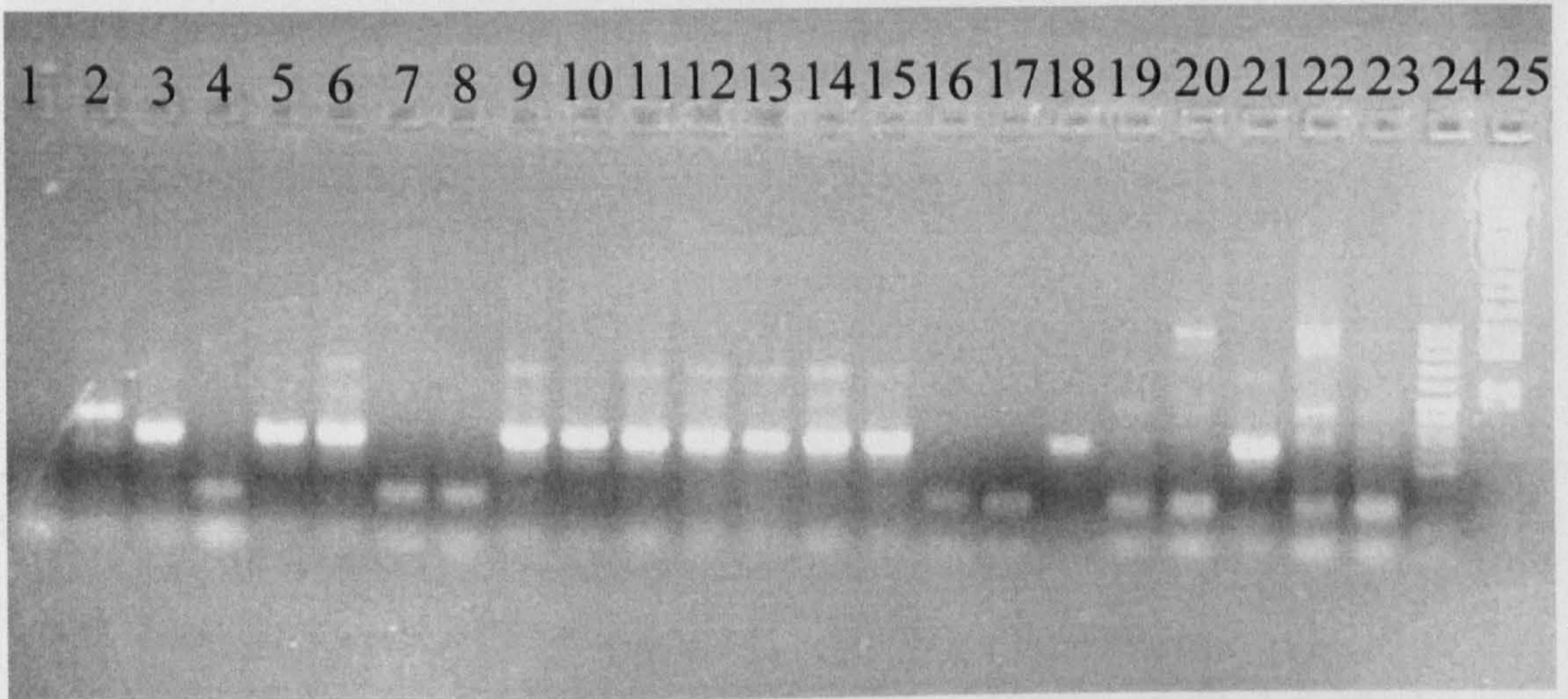

Lane	Sample	Lane	Sample
1	Control (water)	16,17	<i>An. quadriannulatus</i> (CLT) ³
2	<i>An. gambiae s.s.</i> (SUA colony)	18	<i>An. arabiensis</i> (CLT)
3	<i>An. arabiensis</i> (LSHTM colony)	19,20	<i>An. quadriannulatus</i> (CLT)
4	<i>An. quadriannulatus</i> (SKUQUA)	21	<i>An. arabiensis</i> (CLT)
5,6	<i>An. arabiensis</i> (HLT ¹)	22,23	<i>An. quadriannulatus</i> (MLT)
7,8	<i>An. quadriannulatus</i> (HLT)	24	BIOZYM ladder
9	<i>An. arabiensis</i> (HLT)	25	λECO ladder
10-15	<i>An. arabiensis</i> (MLT ²)		

¹HLT = caught in light trap set at house occupied by humans only in Jimma Valley, Ethiopia

²MLT = caught in light trap set at house occupied by humans and animals in Jimma Valley, Ethiopia

³CLT = caught in light trap set in cow shed in Jimma Valley, Ethiopia

Appendix II (continued)

Figure IIb Gel 2: mosquitoes caught in light trap set in house occupied by humans only (in Jimma Valley, Ethiopia).

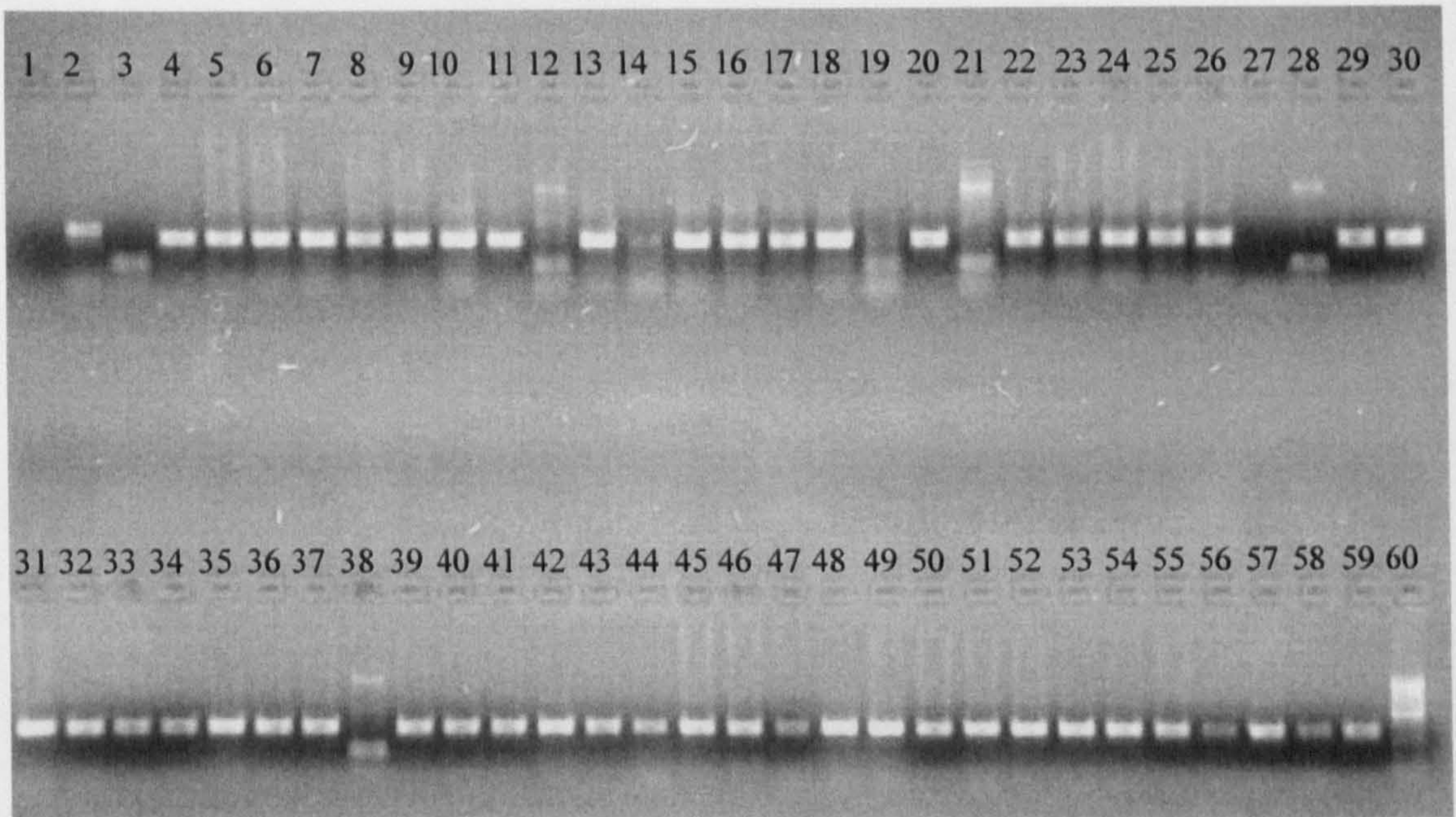

Lane	Sample	Lane	Sample
1	Control (water)	21	<i>An. quadriannulatus</i>
2	<i>An. gambiae s.s.</i> (SUA colony)	22-26	<i>An. arabiensis</i>
3	<i>An. quadriannulatus</i> (SKUQUA)	27	Blank – no PCR product
4-11	<i>An. arabiensis</i>	28	<i>An. quadriannulatus</i>
12	<i>An. quadriannulatus</i>	29-37	<i>An. arabiensis</i>
13-18	<i>An. arabiensis</i>	38	<i>An. quadriannulatus</i>
19	<i>An. quadriannulatus</i>	39-59	<i>An. arabiensis</i>
20	<i>An. arabiensis</i>	60	BIOZYM ladder

Appendix II (continued)

Figure IIc Gel 3: mosquitoes caught in light trap set in cow shed (in Jimma Valley, Ethiopia).

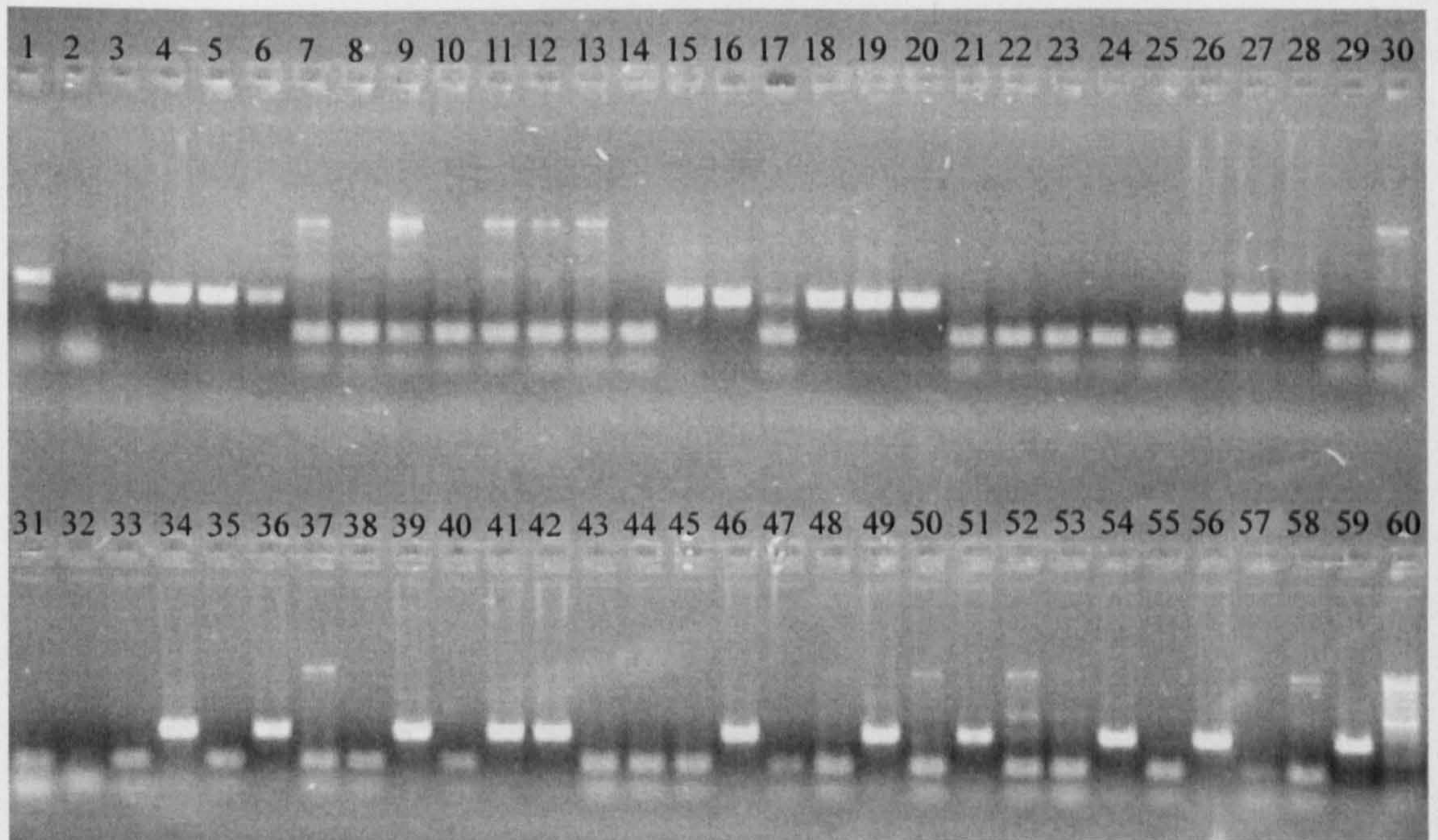

Lane	Sample	Lane	Sample
1	<i>An. gambiae</i> s.s. (SUA colony)	37,38	<i>An. quadriannulatus</i>
2	Control (water)	39	<i>An. arabiensis</i>
3-6	<i>An. arabiensis</i>	40	<i>An. quadriannulatus</i>
7-14	<i>An. quadriannulatus</i>	41,42	<i>An. arabiensis</i>
15,16	<i>An. arabiensis</i>	43-45	<i>An. quadriannulatus</i>
17	<i>An. quadriannulatus</i>	46	<i>An. arabiensis</i>
18-20	<i>An. arabiensis</i>	47,48	<i>An. quadriannulatus</i>
21-25	<i>An. quadriannulatus</i>	49	<i>An. arabiensis</i>
26-28	<i>An. arabiensis</i>	50	<i>An. quadriannulatus</i>
29,30	<i>An. quadriannulatus</i>	51	<i>An. arabiensis</i>
31	<i>An. quadriannulatus</i> (SKUQUA)	52,53	<i>An. quadriannulatus</i>
32	Control (water)	54	<i>An. arabiensis</i>
33	<i>An. quadriannulatus</i>	55	<i>An. quadriannulatus</i>
34	<i>An. arabiensis</i>	56	<i>An. arabiensis</i>
35	<i>An. quadriannulatus</i>	57,58	<i>An. quadriannulatus</i>
36	<i>An. arabiensis</i>	59	<i>An. arabiensis</i>
		60	BIOZYM ladder

Appendix II (continued)

Figure IId Gel 4: mosquitoes caught in light trap set in house occupied by humans and animals (in Jimma Valley, Ethiopia). One *An. quadriannulatus* specimen from the light trap in the cow shed (from Ethiopia) and one hybrid (*An. gambiae s.s.* x *An. quadriannulatus*) from chapter 5 are also shown.

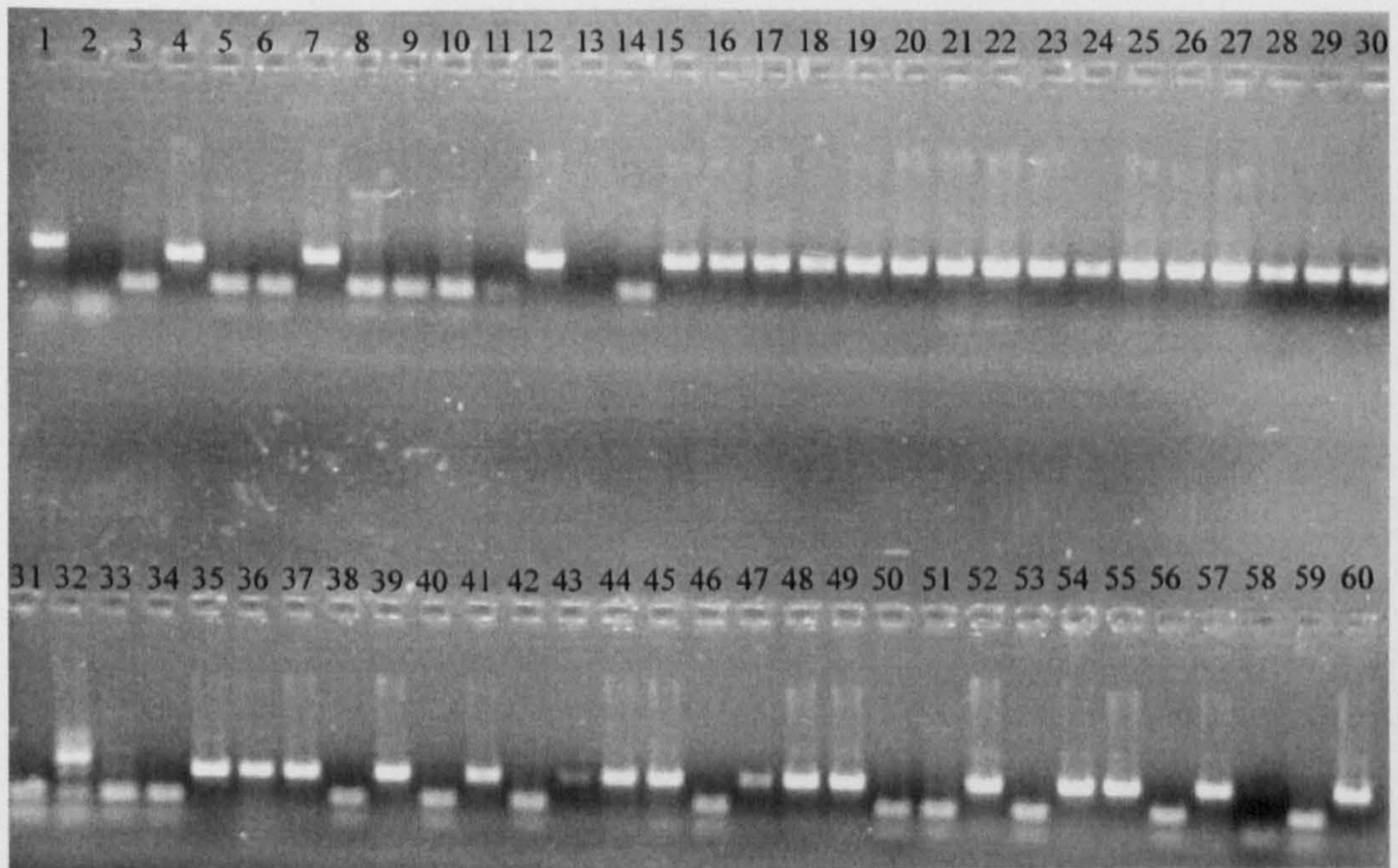

Lane	Sample	Lane	Sample
1	<i>An. gambiae s.s.</i> (SUA colony)	39	<i>An. arabiensis</i>
2	Control (water)	40	<i>An. quadriannulatus</i>
3	<i>An. quadriannulatus</i> (CLT) ¹	41	<i>An. arabiensis</i>
4	<i>An. arabiensis</i>	42	<i>An. quadriannulatus</i>
5,6	<i>An. quadriannulatus</i>	43-45	<i>An. arabiensis</i>
7	<i>An. arabiensis</i>	46	<i>An. quadriannulatus</i>
8-11	<i>An. quadriannulatus</i>	47-49	<i>An. arabiensis</i>
12	<i>An. arabiensis</i>	50,51	<i>An. quadriannulatus</i>
13	Blank – no PCR product	52	<i>An. arabiensis</i>
14	<i>An. quadriannulatus</i>	53	<i>An. quadriannulatus</i>
15-30	<i>An. arabiensis</i>	54-55	<i>An. arabiensis</i>
31	<i>An. quadriannulatus</i> (SKUQUA)	56	<i>An. quadriannulatus</i>
32	Hybrid ²	57	<i>An. arabiensis</i>
33,34	<i>An. quadriannulatus</i>	58	Blank – no PCR product
35-37	<i>An. arabiensis</i>	59	<i>An. quadriannulatus</i>
38	<i>An. quadriannulatus</i>	60	<i>An. arabiensis</i>

¹CLT = specimen caught in light trap from cow shed (in Ethiopia). ²Hybrid = *An. gambiae s.s.* x *An. quadriannulatus* hybrid from experiments performed in chapter 5. Two bands are visible; a *gambiae*-sized band and a *quadriannulatus*-sized band.