

LONDON
SCHOOL of
HYGIENE
& TROPICAL
MEDICINE



MODELLING STUDIES OF THE TRANSMISSION-DYNAMICS AND
HOSPITAL BURDEN OF *CLOSTRIDIUM DIFFICILE*

Esther van Kleef

Thesis submitted in accordance with the requirements for the degree of

Doctor of Philosophy

University of London

November 2015

Department of Infectious Disease Epidemiology

Faculty of Epidemiology & Population Health

LONDON SCHOOL OF HYGIENE & TROPICAL MEDICINE

Funded by the Healthcare Infection Society
Research group affiliation: Modelling & Economics Unit
PUBLIC HEALTH ENGLAND

DECLARATION

I, Esther van Kleef confirm that the work presented in this thesis is my own. Where information has been derived from other sources, I confirm that this has been indicated in the thesis.

Signed:



Esther van Kleef

Date:

19 November 2015

ABSTRACT

Clostridium difficile, a Gram-positive spore-forming bacterium, is a source of considerable morbidity and mortality for patients treated in hospitals and other healthcare settings. Intestinal colonisation by *C. difficile* can cause infection (CDI) if the normal flora is disrupted, e.g. by the use of antimicrobials and some other drugs. Vaccines targeting *C. difficile* main virulence factors, toxins A and B are currently undergoing clinical trials, however, their potential population impact is largely unknown. The work presented in this thesis aims to quantify the effectiveness of *C. difficile* vaccination in preventing hospital-onset CDI, including both its direct effects (reduction in individual patient morbidity and mortality) and indirect effects (prevention of onward transmission of the bacteria) using a mathematical dynamic transmission model framework.

Based on a systematic literature review, it was shown that mathematical dynamic-transmission models have become an increasingly popular tool to help understand the patient-to-patient spread of nosocomial pathogens and predict the impact of healthcare prevention and control strategies. Methods have generally improved, with an increased use of stochastic models, and more advanced methods for formal model fitting and sensitivity analyses. Nonetheless, in contrast to methicillin-resistant *Staphylococcus aureus* – another bacterium commonly found in the healthcare setting – the transmission of *C. difficile* has rarely been considered within a dynamic modelling framework.

Using national English CDI hospital surveillance data to fit a generalised additive mixed-effects model, this thesis revealed that, in line with recent evidence based on highly discriminatory genetic typing-methods, whilst transmission between symptomatic carriers was significant, this did not account for the majority of CDI cases in English hospitals. Asymptomatic carriers have been suggested as co-contributors, but their role in transmission remains uncertain to date.

Previous estimates of additional excess bed days attributable to healthcare-acquired-CDI have varied widely, partly due to methodological weaknesses, and no robust estimates from a European setting are available. Both form key determinants to help quantify the health and economic burden of CDI, and are also likely to have an impact on the transmission-dynamics of the infection. Therefore, this thesis

quantified the hospital burden of CDI, expressed in excess length of stay and mortality. A Cox proportional hazard model revealed that CDI was associated with a significantly decreased daily risk of discharge and increased risk of mortality, where the former was even further reduced for severe CDI patients. Using a multi-state model more intuitive estimates, i.e. the excess length of stay associated with mild (5 days [1.1-9.5]) and severe CDI (11.6 days [95% CI = 3.6-19.6]) were obtained.

Finally, the results of an individual-based “state-of-the-art” dynamic transmission model in an English ICU (with epidemiological parameters informed by the findings of the statistical models mentioned, and with data-driven patient movement between the community, LTCF and ICU) showed that in settings with in-hospital acquisition rates comparable to the national average in English ICUs, immunising three patient groups: LTCF residents, elective patients and patients with a history of CDI in the ICU, resulted in a 43% reduction of ICU-onset CDI. This required a relatively high number of vaccine doses, and a targeted strategy involving patients at high risk of colonisation on admission, such as LTCF residents proved more efficient. As these results proved highly sensitive to the level of antimicrobial use and in-ward acquisition rates, it was concluded that vaccination might be most efficient when targeting patient risk groups or settings where implementation of antimicrobial stewardship proves challenging.

ACKNOWLEDGEMENTS

It is a great pleasure to thank everyone who has helped me during this project. Specifically my four (!) supervisors, Prof. John Edmunds, Dr. Julie Robotham, Dr. Sarah Deeny and Dr. Mark Jit. First of all, thank you to you all for allowing me to try and become an infectious disease modeller. John, a special thanks to you for making time available whenever needed, for teaching me how to write (more) concisely and above all for being such an inspiring example in the field. Julie, thank you for your unconditional faith in me as a scientist, for your patience and for being a sound board whenever I questioned my findings. Sarah, I couldn't be luckier with you as a mental and intellectual guide, thank you for all your daily help and for sharing your breadth of knowledge. Finally, Mark, thank you for all your statistical advice and your critical appraisal of all the work conducted. Also, a special thanks to Barry Cookson, for answering all my microbiological questions, for being always so cheerful and for making sure I didn't forget about the clinical side of things.

At the London School of Hygiene & Tropical Medicine, I have many thanks to make. Firstly, to those in the modelling team (Gwen, Abu, Raphaele, the Greek, Anton, Stefan, Seb, Ken, Adam, Conall, Helen and Olivier) thank you for sharing your modelling and/or Public Health experience, for making the office such a fun and inspiring place to be and for the lovely times spent in the pub. Particular thanks go to Gwen. Thank you for your great support, for your humor and for all the discussions regarding the PhD and beyond. To Andrea, for all the coffees, for making me laugh out loud and for always putting everything in perspective. Finally, my gratitude goes to Antonio Gasparrini, for providing me insight in the value of generalised additive modelling.

At Public Health England I owe thanks to Nathan Green, for his statistical advice and for the insightful and fun discussions on statistical methods and R tips and tricks. A special thanks to Albert Jan van Hoek, to whom I could ask basically any random question, and which would always result in new useful insights and a good laugh as a bonus. Thanks go to my colleagues within the healthcare associated infection and antibiotic resistance department, for preparing the data required as well as sharing their

knowledge.

Thank you to Simon Goldenberg, for providing me with *C. diff* data from Guy's and St Thomas' NHS Trust and for all your help answering my *C. diff* related questions. Also the Healthcare Infection Society I would like to thank for making this PhD studentship financially possible.

Finally I am truly indebted to my family and to Pieter. Thank you Pieter, for your reality checks, your moral support, your endless patience and your unwavering partnership. Mum, Dad, Sis and Bro, without your love and confidence in me, this thesis would not have been possible. It is to you that this thesis is dedicated. Thank you.

TABLE OF CONTENTS

DECLARATION.....	1
ABSTRACT	2
ACKNOWLEDGEMENTS.....	4
TABLE OF CONTENTS	6
LIST OF TABLES.....	8
LIST OF FIGURES.....	9
LIST OF ABBREVIATIONS.....	10
CHAPTER 1	12
INTRODUCTION.....	12
1.1 BACKGROUND.....	12
1.1.1 <i>C. difficile</i> infection.....	12
1.1.2 Risk factors for acquiring CDI.....	13
1.1.3 The burden of CDI.....	14
1.1.4 <i>C. difficile</i> transmission dynamics.....	20
1.1.5 <i>C. difficile</i> prevention and control and the role of vaccination.....	21
1.1.6 Mathematical models to evaluate CDI vaccination policies.....	22
1.2 THESIS OUTLINE	23
1.2.1 Rationale.....	23
1.2.2 Aims and objectives of the thesis.....	24
1.2.3 Structure of the thesis.....	25
1.2.4 Contribution of the candidate to the thesis	26
CHAPTER 2.....	36
MODELLING THE TRANSMISSION OF HEALTHCARE	36
ASSOCIATED INFECTIONS: A SYSTEMATIC REVIEW	36
2.1 PREAMBLE TO RESEARCH PAPER 1	36
2.2 RESEARCH PAPER 1.....	37
CHAPTER 3.....	71
NOSOCOMIAL TRANSMISSION OF <i>C. DIFFICILE</i> IN.....	71
ENGLISH HOSPITALS FROM PATIENTS WITH SYMPTOMATIC.....	71
INFECTION.....	71
3.1 PREAMBLE TO RESEARCH PAPER 2	71
3.2 RESEARCH PAPER 2.....	73
CHAPTER 4.....	101
EXCESS LENGTH OF STAY AND MORTALITY DUE TO	101
<i>CLOSTRIDIUM DIFFICILE</i> INFECTION: A MULTI-STATE	101
MODELLING APPROACH.....	101
4.1 PREAMBLE TO RESEARCH PAPER 3	101

4.2	RESEARCH PAPER 3.....	103
CHAPTER 5	122
	MATHEMATICAL MODEL OF THE POPULATION-LEVEL.....	122
	EFFECT OF <i>CLOSTRIDIUM DIFFICILE</i> VACCINATION AS	122
	PART OF AN INTEGRATED INFECTION CONTROL.....	122
	STRATEGY	122
5.1	PREAMBLE TO RESEARCH PAPER 4.....	122
5.2.	RESEARCH PAPER 4.....	125
CHAPTER 6	177
DISCUSSION	177
6.1	SUMMARY OF THE MAIN FINDINGS.....	177
6.2	IMPLICATIONS FOR HEALTH POLICY AND CLINICAL PRACTICE.....	179
6.3	STRENGTHS AND LIMITATIONS	182
6.3.1	<i>Strengths</i>	183
6.3.2	<i>Limitations</i>	184
6.4	AREAS OF FURTHER RESEARCH.....	185
APPENDIX A: OVERVIEW OF ALL CDI VACCINE CLINICAL TRIALS	193

LIST OF TABLES

TABLE 1: <i>C. DIFFICILE</i> VACCINATION PIPELINE.....	22
TABLE 2: HEALTHCARE INFECTION CONTROL INTERVENTIONS EVALUATED BY A MODELLING FRAMEWORK (1997 – 2011)	46
TABLE 3: DEFINITIONS OF MODELLING TERMS.....	49
TABLE 4: DESCRIPTION OF CDI DATA FROM 46 SELECTED HOSPITALS	79
TABLE 5: DEMOGRAPHIC CHARACTERISTICS OF THE GUY’S & ST THOMAS HOSPITAL PATIENTS DISCHARGED IN 2012	111
TABLE 6: HAZARD RATIOS FOR IN-HOSPITAL DEATH OR DISCHARGE ALIVE AND EXCESS LENGTH OF STAY ESTIMATED FROM THE COX REGRESSION MODEL AND MULTI-STATE MODEL.....	113
TABLE 7: MODEL PARAMETERS AND ASSUMPTIONS.....	132
TABLE 8: NUMBER OF ICU-ONSET CASES PREVENTED PER 1000 ADMISSIONS AND DOSES REQUIRED TO AVERT 1 CASE OF ICU-ONSET CDI FOR ALL SCENARIOS	149
SUPPLEMENTARY TABLE 1: COMPARISON OF MODEL FIT FOR THE BASE-MODEL INCLUDING ALTERNATIVE REPRESENTATIONS OF THE CDI INCIDENCE TREND	97
SUPPLEMENTARY TABLE 2: AVERAGE LENGTH OF STAY POST-INFECTION AND NUMBER OF DEATHS STRATIFIED BY RIBOTYPE	118
SUPPLEMENTARY TABLE 3: VALUES USED IN SCENARIO ANALYSIS	169
SUPPLEMENTARY TABLE 4: VALUES USED IN PROBABILISTIC SENSITIVITY ANALYSIS	169
SUPPLEMENTARY TABLE 5: DAILY PROBABILITY OF DISCHARGE AND DEATH IN THE ICU WARD FOR CDI- AND CDI+ PATIENTS.....	170
SUPPLEMENTARY TABLE 6: MODEL ESTIMATES OF THE MIXED-EFFECT LOGISTIC REGRESSION MODEL	170
SUPPLEMENTARY TABLE 7: ANTIMICROBIAL USE IN THE COMMUNITY AND LTCF	171
SUPPLEMENTARY TABLE 8: IMPORTATION RATES OF INFECTED AND COLONISED INDIVIDUALS	171
SUPPLEMENTARY TABLE 9: MODEL OUTCOME PER 1000 ADMISSIONS FOR EACH OF THE DIFFERENT VACCINATION STRATEGIES AND SCENARIOS UNDER AVERAGE TRANSMISSION ASSUMPTIONS	172
SUPPLEMENTARY TABLE 10: MODEL OUTCOME PER 1000 ADMISSIONS FOR EACH OF THE DIFFERENT VACCINATION STRATEGIES AND SCENARIOS UNDER HIGH TRANSMISSION ASSUMPTIONS	173
SUPPLEMENTARY TABLE 11: MODEL OUTCOME PER 1000 ADMISSIONS FOR EACH OF THE DIFFERENT VACCINATION STRATEGIES AND SCENARIOS UNDER LOW ANTIMICROBIAL USE ASSUMPTIONS ...	174
SUPPLEMENTARY TABLE 12: SCENARIO ANALYSIS FOR ASYMPTOMATIC TRANSMISSION	175
SUPPLEMENTARY TABLE 13: MODEL OUTCOME PER 1000 ADMISSIONS FOR EACH OF THE DIFFERENT VACCINATION STRATEGIES AND SCENARIOS FOR ASYMPTOMATIC TRANSMISSION	176

LIST OF FIGURES

FIGURE 1: YEARLY CDI INCIDENCE AS REPORTED THROUGH THE ENGLISH MANDATORY SURVEILLANCE SYSTEM.....	15
FIGURE 2: FUNNEL PLOT OF THE REPORTED CDI RATES (NON-TRUST AND TRUST APPORTIONED) IN ENGLAND ACROSS ALL TRUSTS FOR THE FINANCIAL YEAR 2014/15	16
FIGURE 3: TIME LINE FOR SURVEILLANCE DEFINITIONS OF CDI.....	18
FIGURE 4: SCHEMATIC OVERVIEW OF THE PHD THESIS.....	25
FIGURE 5 PRISMA FLOWCHART	43
FIGURE 6: NUMBER OF HCAI MODELLING PUBLICATIONS OVER TIME (1993 – 2011)	44
FIGURE 7: PATHOGENS MODELLED IN A NOSOCOMIAL SETTING (1993 – 2011).....	45
FIGURE 8:MAIN INTERVENTIONS EVALUATED OVER TIME (1993 – 2011)	46
FIGURE 9: DEVELOPMENT OF HCAI MODEL STRUCTURE, AND METHODS USED OVER TIME.....	50
FIGURE 10: MILESTONES OF HCAI MODELLING	54
FIGURE 11: OBSERVED WEEKLY NUMBER OF CDI PER HOSPITAL OVER THE FOUR-YEAR STUDY PERIOD	81
FIGURE 12: DEPENDENCE BETWEEN OBSERVED WEEKLY NUMBER OF CDI – BASE-MODEL	83
FIGURE 13: DEPENDENCE BETWEEN OBSERVED WEEKLY NUMBER OF CDI – AR(1)-MODEL.....	85
FIGURE 14: AR(1) MODEL FIT TEACHING HOSPITALS.....	85
FIGURE 15: MODEL FRAMEWORK.....	131
FIGURE 16: MODEL OUTPUT OF 1000 VALUES FOR B_1 (AND $B_2 = B_1/2$; $B_2 = 0$ OR $B_2= B_1$)	139
FIGURE 17: SYMPTOMATIC AND ASYMPTOMATIC ICU- ACQUIRED <i>C. DIFFICILE</i> PER 1000 ADMISSIONS SHOWN FOR ALL FOUR VACCINATION STRATEGIES	147
FIGURE 18: ABSOLUTE NUMBER OF IMPORTED AND ICU-ACQUIRED CDI CASES IN THE ICU PER 1000 ADMISSIONS FOR ALL FOUR VACCINATION STRATEGIES.....	148
FIGURE 19: ABSOLUTE NUMBER OF IMPORTED AND ACQUIRED CASES PREVENTED FOR STRATEGIES 1, 2, 3 AND 4.....	152
FIGURE 20: TOTAL NUMBER OF ICU-ACQUIRED CASES (SYMPTOMATIC AND ASYMPTOMATIC) PER 1000 ADMISSIONS SHOWN FOR ALL FOUR VACCINATION STRATEGIES, AND ALL THREE ASSUMPTIONS FOR ASYMPTOMATIC TRANSMISSION	154
FIGURE 21: CHANGE IN SYMPTOMATIC AND ASYMPTOMATIC ICU-ACQUIRED <i>C. DIFFICILE</i> PER 1000 ADMISSIONS SHOWN FOR ALL FOUR VACCINATION STRATEGIES, AND ALL THREE ASSUMPTIONS FOR ASYMPTOMATIC TRANSMISSION; A) IN THE ICU; B) IN- AND OUTSIDE THE ICU	155
SUPPLEMENTARY FIGURE 1: SEASONAL VARIATIONS OF SYMPTOMATIC <i>C. DIFFICILE</i> INFECTION WITH ONSET >48 HOURS AFTER ADMISSION.....	98
SUPPLEMENTARY FIGURE 2: DIAGNOSTICS OF CUBIC AR(1)-MODELS.....	99
SUPPLEMENTARY FIGURE 3: LENGTH OF STAY HA-CDI CASES STRATIFIED BY HA-CDI PCR RIBOTYPE	119
SUPPLEMENTARY FIGURE 4: MSM WEIGHTS	106

LIST OF ABBREVIATIONS

A

AA : Average Antibiotic use
AIC : Akaike Information Criterion
AHR : Adjusted Hazard Ratio
ARB : Antimicrobial resistant bacteria
AR(1) : Autoregression of order 1
AT : Average Transmission
ATC : Anatomical Therapeutic Chemical

C

CA-CDI : Community-Associated CDI
CDI : *Clostridium difficile* infection
CI : Confidence interval
CRE : Cephalosporin-resistant
CQC : Care Quality Commission

D

DDD : Defined Daily Doses

E

ECDC : European Centre of Disease Control
EIA : Enzyme immunoassay
ESBL : Extended-spectrum beta-lactamases

G

GDH : Glutamate dehydrogenase

H

HA-CDI : Healthcare-associated CDI

L

LA : Vaccine scenario
LHS : Latin Hypercube Sampling
LoS : Length of Stay
LTCF : Long-term care facility

M

MCMC : Markov Chain Monte Carlo
MeSH : Medical Subject Headings
MLST : Multilocus Sequence Typing
MRSA : Methicillin-resistant *Staphylococcus aureus*
MSM : Multi-State Model

N

NAAT : Nucleic acid amplification test
NAP : North American Pulsed Field type
NHS : National Health Service

P

PCR : Polymerase Chain Reaction
PHE : Public Health England
PFGE : Pulsed-field gel electrophoresis

R

REA : Restriction Enzyme Analysis
R-GNR : Resistant Gram-negative rods

S

SARS : Severe Acute Respiratory Syndrome

HALT	: Healthcare-associated infections and Antimicrobial use in Long-Term care facilities	SP	: Sanofi Pasteur
HCAI	: Healthcare-associated infections	T	
HCW	: Healthcare worker	TB	: Tuberculosis
HES	: Hospital Episode Statistics	TcdA	: <i>Clostridium difficile</i> Toxin A
HR	: Hazard Ratio	TcdB	: <i>Clostridium difficile</i> Toxin B
HSCIC	: Health & Social Care Information Centre		
HT	: High Transmission		
		U	
I		UK	: United Kingdom
ICD	: International Classification of Diseases	US	: United States
ICNARC	: Intensive Care National Audit & Research Centre		
ICU	: Intensive care unit	V	
ILI	: Influenza-like illness	VRE	: Vancomycin-resistant Enterococcus
IQR	: Interquartile range		

CHAPTER 1

INTRODUCTION

1.1 BACKGROUND

1.1.1 C. DIFFICILE INFECTION

Clostridium difficile is a Gram-positive, spore-forming bacterium, which can only multiply in anaerobic environments. The name derives from the spindle shape (*kloster* [Greek]) of this bacterium under the microscope, which proved difficult to grow in laboratory conditions (*difficilis* [Latin]). The pathogen was first discovered in 1935 by Hall and O'Toole and described as a coloniser of the normal intestinal flora of new-borns under the name *Bacillus difficilis* [1]. The association with human disease was not made before 1978[2, 3], when *C. difficile* was isolated from patients with antimicrobial-agent-associated pseudomembranous colitis (i.e. inflammation of the large intestine). As part of a healthy normal gut flora, the bacterium is rare, and in general, considered harmless to humans. However, disturbance of the normal gut flora can cause endogenous or ingested *C. difficile* spores to germinate and proliferate in the gastrointestinal tract. In the event of these bacteria having the relevant functioning genes, they can release enterotoxin A and B, which are the bacterium's main virulence factors [4, 5]. These toxins enter the colonic epithelial cells through endocytosis, where they damage the actin cytoskeleton, e.g. inactivate guanosine triphosphatases (GTPases) of the Rho family, hence inducing cell death[6]. Both toxins combined were thought necessary to cause *C. difficile* infection (CDI), however in more recent studies, TcdA⁺TcdB⁻ as well as TcdA⁻TcdB⁺ mutants have been found able to cause disease in animals[7, 8].

The consequences of *C. difficile* in the human gut are diverse: individuals can remain asymptomatic (*C. difficile* colonisation/carriage), which has been largely attributed to individuals' immune response (see below) [9–11], or induce mild to severe clinical manifestations (CDI) varying from diarrhoea [12] to pseudomembranous colitis and even death[13, 14].

1.1.2 RISK FACTORS FOR ACQUIRING CDI

Antimicrobial usage is one of the primary predisposing factors for CDI, in particular broad-spectrum penicillins (e.g. amoxicillin), third-generation cephalosporins (e.g. ceftriaxone, cefotaxime), clindamycin and quinolones [15–17]. The increased susceptibility to acquiring CDI has been estimated to be highest during one month post antibiotic treatment [18]. Another well-recognised risk factor is old age (defined as ≥ 65 years) [16, 19]. The reasons for this are unclear, but are probably several-fold. The elderly, for example, have a weakened immune system, increased presence of severe underlying diseases such as chronic renal disease and inflammatory bowel, conditions which have both been associated with the disease[19]. They also have increased risks from more prolonged/frequent hospitalisations and receipt of more of “at-risk” antimicrobials[19]. Another much debated, but now generally accepted CDI risk factor, is the use of gastro-acid suppressants (e.g. proton pump inhibitors and H₂-receptor antagonists) [20].

Continued exposure to factors disturbing the gut flora post identification of CDI, such as gastric acid suppressors and antibiotic usage, increase the patient’s risk of recurrence [21] (defined here by a second CDI episode within 60 days[22]), which is experienced by about 20 per cent of patients[22]; either due to re-infection or relapse [23]. Importantly, the host’s ability to mount an antibody response to one of *C. difficile*’s main virulence factors, toxin A, is proven to play an important role both in preventing recurrence [24, 25], as well as primary disease[9–11].

The above listed risk factors are frequently present in patients receiving healthcare today. When combined with an enhanced ability of *C. difficile* to spread from patient-to-patient (either directly or indirectly through healthcare workers or the environment, discussed later in section 1.1.4) this provides a “perfect storm” for CDI to be amplified. Indeed, hospitalisation in the previous three months is a recognised risk factor for developing the infection[16, 26]. ICU stay in particular has been recognised as a risk factor for CDI [15, 27, 28]. Although large epidemiological studies in this setting are rare, the severe nature of their underlying disease often causes a state of immunosuppression[29], and requires high levels of antibiotic prescribing[30]. Moreover, due to the high prevalence of stress-related mucosal damage

following severe conditions such as trauma, sepsis or burns[31], gastro-acid suppressants are frequently prescribed among the critical ill patients. The occurrence of nosocomial CDI is discussed in the next section (section 1.1.3.1).

Similarly admission of patients from elderly nursing homes or long-term care facilities (LTCFs) where the prevalence of symptomatic and asymptomatic carriage can be high, has been recognised as a risk factor developing hospital-onset CDI [32]. This creates a potential amplifying “carousel effect” between these settings. This carousel is made all the more complex with the increase in CDI outside healthcare facilities (further discussed in section 1.1.3.3).

1.1.3 THE BURDEN OF CDI

1.1.3.1 *C. DIFFICILE IN THE HOSPITAL-SETTING*

C. difficile is the most common cause of healthcare-associated gastrointestinal infections in England[33], as well as in many countries across Europe [34]. In 2008, an European wide hospital-based survey funded by the European Centres of Disease Control (ECDC) revealed a weighted mean incidence of 4.1 (range: 0 – 36.3) CDI cases per 10,000 patient-days per hospital (i.e. 23 (0 – 276) per 10,000 admissions) across Europe[35]. This was an increase compared to the first European-wide survey based incidence survey in 2005 (2.5 [0.1 – 7.1] per 10 000 patient-days) [36]. The emergence of a *C. difficile* strain with increased virulence dramatically changed the epidemiology of the disease. First introduced in the United States and Canada in 2003, Polymerase Chain Reaction (PCR) ribotype 027 (also referred to as restriction enzyme analysis (REA) type BI or pulsed-field gel electrophoresis (PFGE) type 1 (NAP1)) was associated with fluoroquinolone resistance[37] and large outbreaks of more severe CDI involving an increased risk of mortality and high relapse rates[38, 39]. In 2004, when BI/NAP1/027 reports were dominant among CDI cases in Canada, a prospective cross-hospital study in Quebec revealed an incidence of 225 cases per 10,000 admissions[37]. Similar trends were observed in Northern European countries, including England, as well as Belgium, France, and the Netherlands[40]. In 2014, ECDC supported another European wide survey, of which preliminary results have been presented at the

Healthcare Infection Society conference in 2014. A slight decrease in European wide estimates (3.7 per 10,000 patient-days) was reported; however more details are required to conclude on overall trends.

In 2003/2004, England experienced its first outbreak of BI/NAP1/027 in Stoke Mandeville Hospital[41]. In the few years after that, England has seen sharp increases in the proportion of CDI events caused by this particular strain (i.e. from 25.9% in 2004/2005 to 41.3% in 2007/2008)[42], resulting in large outbreaks and a marked increase in death certificates mentioning *C. difficile*[43]. In response to these developments, all acute National Health Service (NHS) hospital Trusts have become subject to mandatory reporting of identified CDI cases in January 2004[44]. Initially, reporting comprised all CDI patients ≥ 65 years. Three years later, in 2007, this was extended to include cases >2 years old. Moreover, the *C. difficile* Ribotyping Network was introduced which provided culture and ribotyping services for all registered Trusts [45].

With 55,635 annual cases reported (9.4 per 10,000 bed days), CDI incidence reached its peak in 2006 in England (Figure 1). This was followed by a steep decline, which appears to have slowly levelled off, with 13,361 annual reports (3.7 cases per 10,000 bed days) in 2013/14, and a slight increase in the latest financial year (14,165 annual reports, and 3.9 per 10,000 bed days).

Figure 1: Yearly CDI incidence as reported through the English mandatory surveillance system

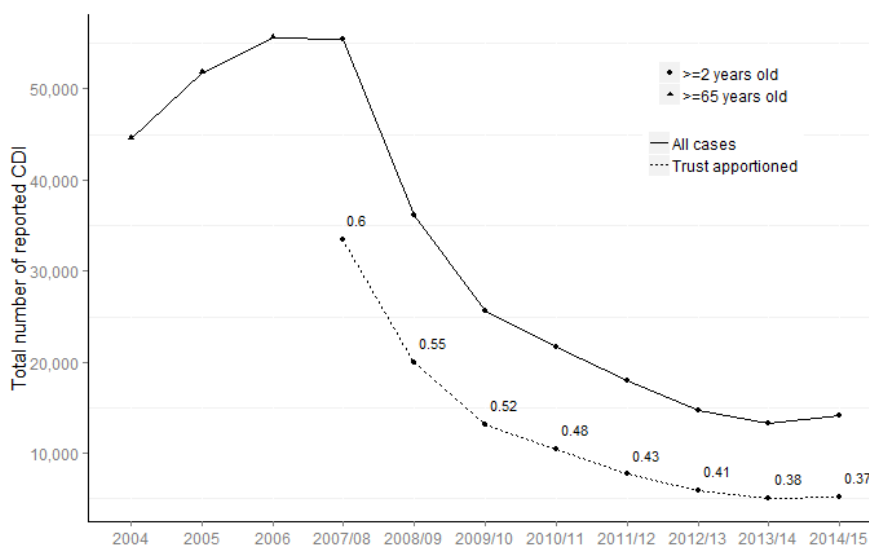

Total number of cases reported by all NHS acute Trusts eligible for reporting to the English mandatory surveillance scheme. The numbers reflect the proportion of CDI cases that were Trust apportioned, defined as onset at least 72h after admission to the hospital. Data: CDI mandatory surveillance database obtained from Public Health England.

A number of different factors may have contributed to the reduction in CDI rates. The introduction of government-led CDI reduction targets in 2007 (imposing, besides enhanced surveillance, improved hospital infection prevention and control and antimicrobial stewardship[33]) as well as a reduction in the prevalence of BI/NAP1/027, which coincided with the observed decline in CDI. Figure 2 illustrates CDI incidence per 10,000 bed days for all England's NHS Trusts in 2014/15 against the national average, standardised by hospital size. To compare, other European countries that reached states of endemic CDI similar to England, such as the Netherlands and Finland, have reported stable incidence rates at 2.9 and 2.3 per 10,000 bed days respectively[46, 47].

Figure 2: Funnel plot of the reported CDI rates (non-Trust and Trust apportioned) in England across all Trusts for the financial year 2014/15

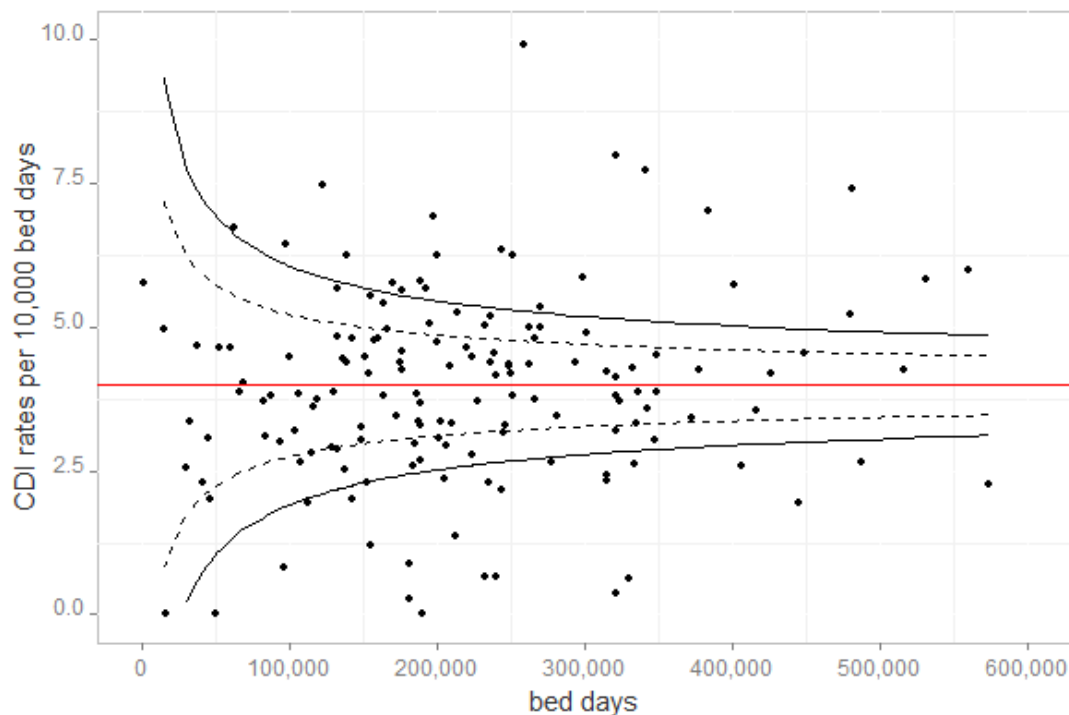

Reported CDI rates per 10,000 bed days (y-axis) as a function of Trust size expressed in the number of yearly bed days (x-axis) in the financial year 2013/2014. Each black dot represents the CDI rates of one NHS acute Trust. The red line corresponds to the national average incidence; the black dashed and solid lines represent the 95th and 99th percentile, respectively. Trusts with reported CDI incidence outside the upper limits have significantly higher rates than the average among Trusts with similar annual bed days, whereas Trusts with reports outside the lower confidence limit have significantly lower rates.

A wide variation in CDI incidence reports across Trusts is observed, with 25% (38) of the Trusts reporting higher incidences than the 95th percentile for Trusts of similar size (Figure 2). This relates in part to variability in hospital characteristics such as hospital demographics and case-mix (in Chapter 3 it is

shown that teaching hospitals have generally higher number of reports than general and specialised hospital). Nonetheless, also considering the recent increases in CDI incidence and lower stable incidence rates reported elsewhere, this suggests there remains scope for further efforts in the prevention and control of CDI in England.

1.1.3.2 *C. DIFFICILE IN LONG-TERM CARE FACILITIES*

Routine data on CDI prevalence among the elderly residing in long-term care facilities (LTCF) is currently non-existent, and prevalence studies on symptomatic and/or asymptomatic carriage are sparse. Asymptomatic colonisation prevalence is thought to be generally high compared to other (community) settings. Carriage rates of 2-4 per cent[48–50] have been found among healthy elderly participants residing outside the hospital and long-term care facilities (LTCFs), whereas a recent systematic review found a weighted average of 14.8% (95% CI 7.6 – 24.0) in LTCFs[51]. The case-mix of these facilities (elderly, requiring frequent antibiotic use and hospitalisation, e.g.[52, 53]), have been suggested as contributing factors. Point-prevalence surveys of healthcare-associated infections (HCAI) and antibiotic use in European LTCFs commissioned by ECDC have provided some insights in CDI prevalence. The latest survey in 2013 revealed low CDI incidence in LTCFs across Europe. Overall, 3.4% (range: 0.4 – 9.5) of the residents were found positive for a health-care associated infection[54]. Five per cent of these were gastrointestinal, and *C. difficile* caused 17.7% (range: 0 - 100) of these infections. However, it was acknowledged that over half of the countries involved provided data from LTCFs that were non-representative for the nation.

Admissions from LTCF have been associated with increased risk of hospital-onset CDI[32] and residing in an LTCF has been identified as an independent risk-factor for developing CDI[55]. The frequent interaction between hospital and LTCF populations, and the vulnerability of the latter patient group, highlight the need for accurate estimates of the health burden of CDI in these settings.

1.1.3.3 *C. DIFFICILE IN THE COMMUNITY*

In the United Kingdom (UK), between 1994 and 2004, at a time CDI incidence increased, a population-based study using the General Practice Research database[56] revealed that the number of patients with CDI reported in the community, with no hospitalisation in the previous year increased as well[57]. Similar patterns were observed in the US [58, 59] and elsewhere [60]. These community-associated CDI (CA-CDI) cases, commonly defined as patients with onset of symptoms in the community and no hospitalisation in the preceding 12 weeks [61, 62] (Figure 3), have been correlated with younger age [63, 64] and less severe co-morbidity [63, 65]. The association with antibiotic use in these cases is less clear, i.e. numbers of cases associated with previous antibiotic usage have been found to be lower among CA-CDI cases e.g. [63]. Nonetheless, a recent meta-analysis involving nine studies concluded antibiotic exposure remained a major risk factor for CDI in the community [66].

Figure 3: Time line for surveillance definitions of CDI

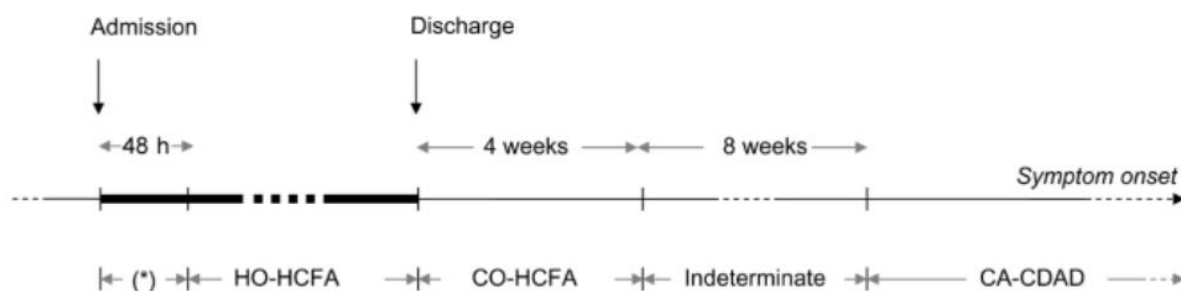

Source: [61, 62]

Heightened awareness of CDI (reflected in the introduction of voluntary and mandatory national surveillance systems globally [35, 67]), might have been partly responsible for the observed increases in CA-CDI incidence. Also, non-standardisation in definitions used for CA-CDI [64, 68], hampers comparison of reported incidence of CA-CDI over time and across countries and settings. The English mandatory surveillance definition for non-Trust apportioned CDI (i.e. onset of CDI within three days after admission) is problematic in that it ignores onset related to recent hospitalisation, as well as enabling potential misclassification due to reporting delays. Since its introduction in 2007, the reported fraction of non-Trust apportioned CDI has increased consistently over time (see Figure 1). This could suggest a

continuing increase in community-acquisitions, but is perhaps more likely to be a consequence of the successful prevention of healthcare-acquired CDI.

Despite these recent developments, the majority of reported CDI continues to be healthcare-associated in Europe and North America. In the US, which in 2009 introduced a population-based surveillance scheme for CDI comprising both hospital and GP reports, about one-third of the cases were identified as community-associated in the ensuing two years [69, 70]. Similarly, population-based studies in Sweden [65] and Canada[71] identified 28% and 27% respectively of all CDI cases as community-associated. Also, in 2008, the aforementioned European-wide hospital survey reported that, although the percentage of the identified cases that were community-associated (i.e. onset of CDI in the community and no admission to a healthcare facility (hospital or nursing home) in the previous 12 weeks) varied; the majority (75/83) of the participating hospitals reported higher proportions of healthcare-associated CDI[35]. However, considering there is a lack of structural, population-based CDI studies involving the testing of patients with diarrhoea both in the community and the healthcare setting, showing either presence or absence of common risk factors [68], it remains difficult to establish the true burden of CDI outside healthcare facilities.

1.1.3.4 *ECONOMIC BURDEN OF C. DIFFICILE*

The preceding sections have emphasised the significance of the health burden of CDI. As a result, CDI places a marked economic burden on healthcare systems. However, the majority of studies on the economic healthcare costs associated with CDI originate from the US, and have focused largely on the direct costs associated with hospitalised patients[72]. Estimates of incremental costs of the disease vary from \$2,871 to \$30,049 per (primary) hospital-onset CDI case [72, 73]. These estimated costs were mainly driven by the additional number of hospital-bed days required for infected individuals[72, 73]. Although general consensus is that CDIs are responsible for excess lengths of stay (LoS), e.g. [74, 75] as well as mortality, e.g. [76], estimates for this excess LoS have varied widely from 0 to 21 days[75, 77]. These studies have mostly suffered from inappropriate methods used, for example fail to account for time-dependent bias (i.e. the timing of onset of infection), and competing risk events (such as discharge and death)[77]. The former is likely to result in an overestimation of the excess number of bed-days, as

patients that stay in hospital longer, are at increased risk of acquiring the infection. This has been shown extensively for other healthcare-associated infections [78–81]. In contrast, ignoring competing risk events might underestimate additional stay, since patients that acquire the disease could be at increased risk of experiencing death [82, 83].

Estimates of excess bed-days and mortality due to disease form the current basis for cost-effectiveness analysis and policy-making[84]. Therefore, more robust studies, quantifying these individual patient outcomes are highly needed. In particular studies in European-settings are lacking, as is research investigating the impact of (heterogeneity in) individual patient characteristics.

1.1.4 C. DIFFICILE TRANSMISSION DYNAMICS

Transmission of *C. difficile* occurs via the faecal-oral route; i.e. humans can ingest the vegetative form of *C. difficile* or its spores. The vegetative form is unlikely to survive the acidity of the stomach. The spores however, can pass through to the intestine, where they can germinate into vegetative bacteria. The spores are released in the faeces and can persist in the environment for several weeks [85]. The shedding of *C. difficile* spores into the (hospital) environment by CDI patients with diarrhoea makes this group of *C. difficile* carriers a likely source of *C. difficile* transmission, either directly or indirectly (through contaminated surfaces or hands of healthcare workers). Indeed, *C. difficile* spores have been recovered from the skin and hospital rooms of symptomatic patients, as well as hands of healthcare workers treating symptomatic carriers [86–88], and to a lesser extent of asymptomatic carriers [52, 87, 89, 90].

In more recent years, CDI acquisition from (inpatient) symptomatic carriers was found less prevalent than generally assumed [91–93]. Only 20 per cent of hospital-onset cases of CDI were found to share an epidemiological link or, indeed genomic link (as analysed by multi-locus-sequence typing (MLST)[91] and whole genome sequencing (WGS) analyses) with symptomatic CDI cases, from 2008 to 2011 in Oxfordshire, UK [92, 93]. Interestingly, patients carrying BI/NAP1/027 were found to be linked more commonly to other in-hospital patients (~60 per cent), supporting the hypothesis that certain strains are associated with higher transmissibility than others[92]. Eyre et al (2013) discovered (also in Oxfordshire) high levels of genomic diversity in hospital and community isolates from symptomatic CDI cases [93]. This recent evidence suggests other routes of transmission, such as via asymptomatic carriers

or an environmental source might be of equal or some importance to acquisition; at least in endemic settings. Good-quality studies investigating the transmission potential of asymptomatic carriers have been limited. Using multi-locus variable number of tandem repeats analysis (MLVA), Curry and colleagues (2013) found that a similar percentage of cases was associated with symptomatic (~30 per cent) as with asymptomatic carriers (~29 per cent) [94] in a US university hospital. Asymptomatic carriers outnumber their symptomatic counterparts (with ratios of 4:1 being suggested, e.g.[13, 86]); this, in combination with their lower frequency of skin and environmental contamination, might suggest the former could act as a reservoir for acquisition, albeit with lower per capita infectivity.

The transmission-dynamics of CDI and role of asymptomatic carriers in the transmission of *C. difficile* remains uncertain to date. The majority of these studies have been limited to one geographical area and further epidemiological studies using e.g. national datasets are needed to identify whether similar patterns are observed elsewhere.

1.1.5 C. DIFFICILE PREVENTION AND CONTROL AND THE ROLE OF VACCINATION

Infection prevention and control methods for CDI currently involve measures to reduce *C. difficile* spread (e.g. environmental cleaning, contact precautions such as isolation and improved hand hygiene with soap and water (alcohol does not kill *C. difficile* spores), and efforts to decrease patient susceptibility to CDI when exposed to *C. difficile*, primarily through improved antimicrobial stewardship[62, 95]. These measures of course have the potential to interact and so maximise reductions in the levels of *C. difficile* acquisition.

The receptor-binding domains of *C. difficile* toxins A and B (TcdA and TcdB) have been the target for vaccine development [96]. By using such toxoid vaccines, an IgG antibody response is induced and hence damage to the colonic mucosa, i.e. infection, prevented at the time of *C. difficile* colonisation [97–101]. Hence, such a vaccine is not thought to protect patients from asymptomatic *C. difficile* colonisation[9, 102]. A *C. difficile* toxoid vaccine, with and without adjuvant, developed by Sanofi-Pasteur is currently undergoing phase III clinical trials. Other companies also have products in various phases of clinical development (Table 1 and Appendix A).

Table 1: *C. difficile* vaccination pipeline

Vaccine	Antigen	Clinical phase	Trial number
Sanofi Pasteur ACAM-CDIFF™	Formalin Inactivated toxins A and B from VPI 10463	III	NCT01887912
Valneva VLA84 (former Intercell IC84)	Recombinant fusion protein of toxin A and B binding regions	II	NCT02316470
Pfizer PF-06425090	Recombinant toxin A and B mutants, chemically inactivated	II	NCT02117570

If vaccination does reduce the risk of developing diarrhoea and colitis, it has the potential to reduce healthcare costs not only by preventing primary onset, but also by reducing the spread of infectious spores into the environment, and subsequently to other individuals. Assessing this potential population-level effect will require careful population-based studies and/or mathematical models.

1.1.6 MATHEMATICAL MODELS TO EVALUATE CDI VACCINATION POLICIES

Mathematical models have proven useful in understanding the transmission of infectious pathogens, as well as the impact of single or combined intervention strategies [103, 104]. An important strength of such mechanistic models is that scenarios can be investigated, which would be considered unethical or unfeasible for studies using, for example, randomised-controlled trials. Also, indirect effects, such as herd-immunity (i.e. the reduction in the number of infectious individuals in the population leading to other patients being at decreased risk of acquiring an infection) can be captured using dynamic models, where the risk of infection changes over time, and is dictated by the number of infectious individuals in a population [105]. Mathematical modelling has therefore become a well-established tool for integrating information from epidemiological studies and vaccine trials in order to estimate the population-level impact of vaccination [106, 107].

Models simulating *C. difficile* transmission are rare when compared to pathogens of comparable significance, such as methicillin-resistant *Staphylococcus aureus* (MRSA) (see Chapter 2 and Chapter 5). Lee *et al* (2010) remain the only group to estimate the cost-effectiveness of a hypothetical CDI vaccine. The authors used a static decision analytic approach, i.e. assumed a fixed (independent from the number of

infected individuals) risk of infection. They therefore did not incorporate the potential indirect effects of vaccination. The study compared outcomes of vaccinating patients at risk of primary CDI to a strategy involving the vaccination of patients at risk of recurrence. No details were provided on specific settings and on what target groups would involve these at risk populations[108]. Outcomes were found to be highly sensitive to the risk of acquiring CDI, emphasising that the added value of the vaccine may highly vary from setting-to-setting. Moreover, when a CDI vaccine reaches the market, modelling can provide useful insights into the appropriate target populations for vaccination.

1.2 THESIS OUTLINE

1.2.1 RATIONALE

To summarise the above, CDI is a major cause of gastro-intestinal infections globally. CDI incidence in England has seen major reductions, but recent increases have been observed and there is still a significant disease burden. The patient populations in England and most of Europe are increasingly aged with greater risks of CDI. This together with modern and complex healthcare delivery provides additional challenges to sustaining any CDI reductions. In addition, other healthcare systems outside Europe have not been as successful in implementing CDI reduction measures, most notably antibiotic stewardship[109]. The current burden, and spectre of increasing CDI have resulted in the progression of Phase III clinical trials on a vaccine targeting *C. difficile* TcdA and TcdB. Mathematical models have proven useful for providing insights into the potential of vaccination and the (cost)-effectiveness of different vaccine and other prevention and control strategies. Mathematical models of CDI have been rare, but insights from other infections, commonly associated with healthcare-settings, could aid in deciding the most appropriate modelling framework.

Any such model requires proper understanding of the epidemiology of the disease. In recent years, changes in our thinking regarding the epidemiology of CDI have occurred. Importantly: awareness of the occurrence of CDI in the community has increased; and sources other than symptomatic carriers are suggested to contribute to hospital-onset of CDI.

Despite these developments, the onset of CDI continues to be primarily hospital-acquired, where it has been responsible for major attributable costs. Therefore, if the vaccine is found to be efficacious on an individual level in the clinical trials, it is likely to have a marked impact when preventing cases in hospital-settings. Estimates of these costs have been primarily driven by excess bed-days, of which robust numbers from European-settings are lacking. Moreover, among the few studies that use appropriate methodology, estimates vary widely. Hence there remains considerable uncertainty in the literature on the impact of CDI on length of stay.

Any examination of the overall impact of vaccination needs to account for (uncertainty in) the potential role of asymptomatic carriers to transmission as well as the potential influence of the community population, including LTCF where asymptomatic carriage is commonly found. Mathematical models aiming to simulate transmission and evaluate CDI vaccine effectiveness should therefore incorporate movements between hospital and community-populations, and, if evaluating cost-effectiveness, should pay particular attention to the quantification of (the dominant cost-driver) excess hospital stay.

1.2.2 AIMS AND OBJECTIVES OF THE THESIS

The primary aim of this PhD thesis is to determine - through detailed analysis of the transmission dynamics and burden of *C. difficile* - the potential role of vaccination in the prevention of nosocomial spread of CDI. In order to reach the overall aim of the thesis, the following study objectives were defined:

- 1) To develop a comprehensive overview of existing mathematical models of HCAI transmission-dynamics and prevention and control. Hence, define what modelling methods are most appropriate for the investigation and evaluation of the spread of *C. difficile* and the potential effectiveness of *C. difficile* vaccination.

- 2) To improve our understanding of *C. difficile* epidemiology by investigating the level of patient-to-patient transmission between symptomatic carriers in the hospital setting on a national level.

- 3) To provide the first robust estimate of the burden of *C. difficile* expressed in excess length of hospital stay and hospital mortality in England.

- 4) To use the evidence generated from objective one, two and three to develop a mathematical dynamic transmission model to investigate the spread of nosocomial *C. difficile*, and evaluate the effectiveness of infection prevention and control strategies involving vaccination in an English hospital setting.

1.2.3 STRUCTURE OF THE THESIS

This section describes in brief terms the outline of the thesis. The primary content of each chapter is described, and Figure 4 provides a schematic overview of the entire PhD thesis content.

Figure 4: Schematic overview of the PhD thesis

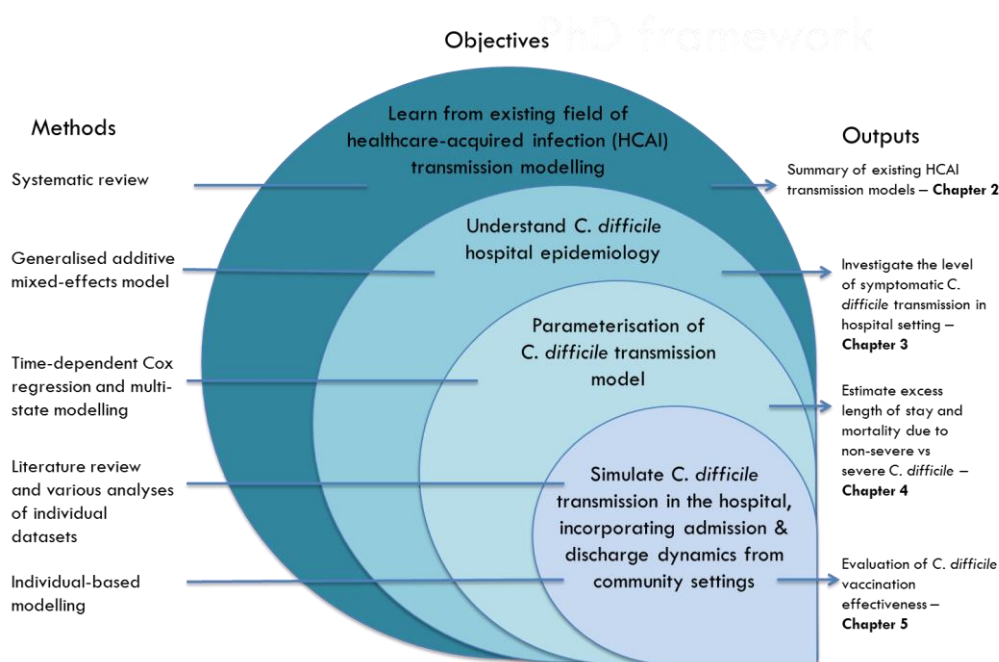

Chapter 2: Presents the results of a systematic review, which was conducted to meet objective one. The status quo of the field of dynamic-transmission modelling of healthcare-acquired infections is discussed, i.e. the pathogens modelled, the research themes investigated, the methods employed and how these methods have developed over time.

Chapter 3: Describes the role of symptomatic carriers in the transmission-dynamics of *C. difficile* in the hospital-setting, in order to gain better understanding of the hospital epidemiology of *C. difficile*, and therefore addresses objective two. By means of generalised-additive mixed-effects modelling techniques the study makes novel use of routinely collected weekly incidence English *C. difficile* mandatory surveillance data.

Chapter 4: Demonstrates the impact of healthcare-acquired CDI (HA-CDI) on a patient's expected length of stay in hospital and risk of in-hospital mortality, to improve our understanding of the health and economic burden that *C. difficile* creates in England, therefore addressing objective three. Multi-state modelling (MSM) and Cox-proportional hazard models are employed to account for time-dependent bias and competing risks and used to realise objective three.

Chapter 5: Provides a detailed account of the development and parameterisation of the individual-based *C. difficile* model. Evidence was synthesised from multiple sources, and numerous analyses undertaken for model parameterisation. The developed model was then used to assess the effectiveness of vaccination in preventing the transmission of *C. difficile* in high-risk settings. Hence this meets objective four, as well as the overall objective of this thesis.

Chapter 6: Discusses the implications of the findings of all studies in the context of existing evidence. Moreover, areas for future research are discussed.

1.2.4 CONTRIBUTION OF THE CANDIDATE TO THE THESIS

The work conducted on this thesis was linked to a major research grant funded by the Healthcare Infection Society (U.K. Registered Charity No. 286064). Three papers have been published based on the work undertaken in this thesis, which are presented in Chapters 2, 3 and 4. The research for these papers

was conducted during the time of PhD registration. The candidate was the lead and corresponding author for all papers, carried out the literature review and/or analysis and prepared all drafts of the paper. The co-authors' contributions to the manuscripts were restricted to providing comments on the drafts prepared by the candidate. More detailed account of the contribution of the candidate and of the co-authors to the work presented in this thesis is outlined at the start of each thesis chapter.

References

1. Hall I, O'Toole E: **Intestinal flora in new-born infants with a description of a new pathogenic anaerobe, bacillus difficilis.** *Am J Dis Child* 1935, **49**:390.
2. George WL, Sutter VL, Goldstein EJ, Ludwig SL, Finegold SM: **Aetiology of antimicrobial-agent-associated colitis.** *Lancet* 1978, **1**:802–803.
3. Bartlett J, Moon N, Chang T, Taylor N, Onderdonk A: **Role of Clostridium difficile in antibiotic-associated pseudomembranous colitis.** *Gastroenterology* 1978, **75**:778–782.
4. Wilson KH: **The microecology of Clostridium difficile.** *Clin Infect Dis* 1993, **16 Suppl 4**:S214–8.
5. Kelly CP, Lamont JT: **Clostridium difficile infection.** *Annu Rev Med* 1998, **49**:375–390.
6. Rupnik M, Wilcox MH, Gerding DN: **Clostridium difficile infection: new developments in epidemiology and pathogenesis.** *Nat Rev Microbiol* 2009, **7**:526–536.
7. Kuehne S a, Cartman ST, Heap JT, Kelly ML, Cockayne A, Minton NP: **The role of toxin A and toxin B in Clostridium difficile infection.** *Nature* 2010, **467**:711–713.
8. Lyras D, O'Connor JR, Howarth PM, Sambol SP, Carter GP, Phumoonna T, Poon R, Adams V, Vedantam G, Johnson S, Gerding DN, Rood JI: **Toxin B is essential for virulence of Clostridium difficile.** *Nature* 2009, **458**:1176–1179.
9. Kyne L, Warny M, Qamar A, Ciaran P: **Asymptomatic carriage of clostridium difficile and serum levels of IgG antibody against toxin A.** *N Engl J Med* 2000, **10**:390–397.
10. Kelly P, Kyne L: **The host immune response to Clostridium difficile.** *J Med Microbiol* 2011:1070–1079.
11. Loo V, Bourgault A, Poirier L, Lamoth F, Michaud S, Turgeon N, Baldwin T, Beaudoin A, Frost E., Gilca R, Brassard P, Dendukuri N, Beliveau C, M O, Brukner I, Dascal A: **Host and Pathogen Factors for Clostridium difficile Infection and Colonization.** *N Engl J Med* 2011, **365**:1693–1703.
12. Fraise AP, Bradley C: *Ayliffe's Control of Healthcare-Associated Infection: A Practical Handbook.* Hodder Arnold; 2009.
13. Johnson S, Clabots C, Lin F, Olson M, Peterson L, Gerding D: **Nosocomial Clostridium difficile colonisation and disease.** *lancet Clin Pract* 1990, **14**:97–100.
14. Gerding DN, Johnson S, Peterson LR, Mulligan ME, Silva J: **Clostridium difficile-associated diarrhea and colitis.** *Infect Control Hosp Epidemiol* 1995, **16**:459–477.
15. Bignardi GE: **Risk factors for Clostridium difficile infection.** *J Hosp Infect* 1998, **40**:1–15.
16. Dubberke ER, Reske KA, Yan Y, Olsen MA, Mcdonald LC, Fraser VJ: **Clostridium difficile – Associated Disease in a Setting of Endemicity : Identification of Novel Risk Factors.** *Clin Infect Dis* 2007, **2005**:1543–1549.
17. Wiström J, Norrby SR, Myhre EB, Eriksson S, Granström G, Lagergren L, Englund G, Erik C, Svenungsson B: **Frequency of antibiotic-associated diarrhoea in 2462 antibiotic-treated hospitalized patients : a prospective study.** *J Antimicrob Chemother* 2001, **47**:43–50.

18. Hensgens MPM, Goorhuis A, Dekkers OM, Kuijper EJ: **Time interval of increased risk for Clostridium difficile infection after exposure to antibiotics.** *J Antimicrob Chemother* 2012, **67**(December 2011):742–748.
19. Mcfarland L V, Surawicz CM, Stamm WE, Mcfarland L V, Surawicz CM, Stamm WE: **Risk Factors for Clostridium difficile Carriage and C difficile-Associated Diarrhea in a Cohort of Hospitalized Patients.** 1990, **162**:678–684.
20. Janarthanan S, Ditah I, Phil M, Adler DG, Ehrinpreis MN: **Clostridium difficile -Associated Diarrhea and Proton Pump Inhibitor Therapy : A Meta-Analysis.** *Am J Gastroenterol* 2012, **107**:1001–1010.
21. Garey KW, Sethi S, Yadav Y, DuPont HL: **Meta-analysis to assess risk factors for recurrent Clostridium difficile infection.** *J Hosp Infect* 2008, **70**:298–304.
22. Eyre DW, Walker a S, Wyllie D, Dingle KE, Griffiths D, Finney J, O'Connor L, Vaughan A, Crook DW, Wilcox MH, Peto TE a: **Predictors of first recurrence of Clostridium difficile infection: implications for initial management.** *Clin Infect Dis* 2012, **55 Suppl 2**(Suppl 2):S77–87.
23. Wilcox M., Fawley WN, Settle CD, Davidson A: **Recurrence of symptoms in Clostridium difficile infection - relapse or reinfection?** *Hosp Infect Soc* 1998, **38**:93–100.
24. Kyne L, Warny M, Qamar A, Kelly CP: **Early report Association between antibody response to toxin A and protection against recurrent Clostridium difficile diarrhoea.** *Lancet* 2001, **357**:189–93.
25. Warny M, Vaerman J, Avesani V, Delmeei M: **Human antibody response to Clostridium difficile toxin A in relation to clinical course of Infection.** *Infect Immun* 1994.
26. Loo VG, Bourgault A-M, Poirier L, Lamothe F, Michaud S, Turgeon N, Tuye B, Beaudoin A, Frost EH, Gilca R, Brassard P, Dendukuri N, Béliveau C, Oughton M, Brukner I, Dascal A: **Host and Pathogen Factors for Clostridium difficile Infection and Colonization.** *N Engl J Med* 2011, **365**:1693–1703.
27. Dubberke ER, Yan Y, Reske K a, Butler AM, Doherty J, Pham V, Fraser VJ: **Development and validation of a Clostridium difficile infection risk prediction model.** *Infect Control Hosp Epidemiol* 2011, **32**:360–6.
28. Hensgens MPM, Goorhuis A, van Kinschot CMJ, Crobach MJT, Harmanus C, Kuijper EJ: **Clostridium difficile infection in an endemic setting in the Netherlands.** *Eur J Clin Microbiol Infect Dis* 2011, **30**:587–93.
29. Markwart R, Condotta S a., Requardt RP, Borken F, Schubert K, Weigel C, Bauer M, Griffith TS, Förster M, Brunkhorst FM, Badovinac VP, Rubio I: **Immunosuppression after Sepsis: Systemic Inflammation and Sepsis Induce a Loss of Naïve T-Cells but No Enduring Cell-Autonomous Defects in T-Cell Function.** *PLoS One* 2014, **9**:e115094.
30. Public Health England (former Health Protection Agency): *English National Point Prevalence Survey on Healthcare-Associated Infections and Antimicrobial Use , 2011 - Appendices.* 2011.
31. Brett S: **Science review: The use of proton pump inhibitors for gastric acid suppression in critical illness.** *Crit care* 2005, **9**:45–50.

32. Ricciardi R, Nelson J, Griffith JL, Concannon TW: **Do admissions and discharges to long-term care facilities influence hospital burden of Clostridium difficile infection?** *J Hosp Infect* 2012, **80**:156–61.
33. National Audit Office: *Reducing Healthcare Associated Infections in Hospitals in England*. 2009(June).
34. European Centre for Disease Prevention and Control: *Point Prevalence Survey of Healthcare-Associated Infections and Antimicrobial Use in European Acute Care Hospitals*. Stockholm; 2012.
35. Bauer MP, Notermans DW, van Benthem BHB, Brazier JS, Wilcox MH, Rupnik M, Monnet DL, van Dissel JT, Kuijper EJ: **Clostridium difficile infection in Europe: a hospital-based survey.** *Lancet* 2011, **377**:63–73.
36. Barbut F, Mastrantonio P, Delmee M, Brazier J, Kuijper E, Poxton I: **Prospective study of Clostridium difficile infections in Europe with phenotypic and genotypic characterisation of the isolates.** *Clin Microbiol Infect* 2007, **13**:1048–1057.
37. Loo V., Poirier L, Miller MA, Oughton M, Libman MD, Michaud S, Bourgault, Nguyen T, Frenette C, Kelly M, Vibien A, Brassard P, Fenn S, Dewar K, Hudson TJ, Horn R, Rene P, Monczak Y, Dascal A: **A Predominantly Clonal Multi-Institutional Outbreak of Clostridium difficile –Associated Diarrhea with High Morbidity and Mortality.** *N Engl J Med* 2005, **353**.
38. See I, Mu Y, Cohen J, Beldavs ZG, Winston LG, Dumyati G, Holzbauer S, Dunn J, Farley MM, Lyons C, Johnston H, Phipps E, Perlmutter R, Anderson L, Gerding DN, Lessa FC: **NAP1 strain type predicts outcomes from Clostridium difficile infection.** *Clin Infect Dis* 2014, **58**:1394–400.
39. Walker a S, Eyre DW, Wyllie DH, Dingle KE, Griffiths D, Shine B, Oakley S, O'Connor L, Finney J, Vaughan A, Crook DW, Wilcox MH, Peto TE a: **Relationship Between Bacterial Strain Type, Host Biomarkers, and Mortality in Clostridium difficile Infection.** *Clin Infect Dis* 2013, **56**:1589–600.
40. Kuijper EJ, Coignard B, Tu P: **Emergence of Clostridium difficile -associated disease in North America and Europe.** 2006:2–18.
41. Smith A: **Outbreak of Clostridium diffi cile infection in an English hospital linked to hypertoxin-producing strains in Canada and the US.** *Euro Surveill* 2005, **10**:2735.
42. Brazier JS, Raybould R, Patel B, Duckworth G, Pearson A, Charlett A, Duerden BI: **Distribution and antimicrobial susceptibility patterns of Clostridium difficile PCR ribotypes in English hospitals, 2007-08.** *Euro Surveill* 2008, **13**:1–5.
43. Office for National Statistics: *Statistical Bulletin Deaths Involving Clostridium Difficile : England and Wales , 2006 to 2010*. Newport; 2011(August).
44. **Clostridium difficile infection: annual data**
[<https://www.gov.uk/government/statistics/clostridium-difficile-infection-annual-data>]
45. Wilcox MH, Shetty N, Fawley WN, Shemko M, Coen P, Birtles A, Cairns M, Curran MD, Dodgson KJ, Green SM, Hardy KJ, Hawkey PM, Magee JG, Sails a D, Wren MWD: **Changing Epidemiology of Clostridium difficile Infection Following the Introduction of a National Ribotyping-Based Surveillance Scheme in England.** *Clin Infect Dis* 2012, **55**.
46. Kanerva M, Mentula S, Virolainen-Julkunen a., Kärki T, Möttönen T, Lyytikäinen O: **Reduction in Clostridium difficile infections in Finland, 2008-2010.** *J Hosp Infect* 2013, **83**:127–131.

47. Van Dorp S, Notermans D, De Greeff S, Harmanus C, Kuijper E: **Sentinel surveillance for Clostridium difficile infections in The Netherlands reveals stable incidence.** In *ECCMID 2015 conference abstract*; 2015.
48. Miyajima F, Roberts P, Swale A, Price V, Jones M, Horan M, Beeching N, Brazier J, Parry C, Pendleton N, Pirmohamed M: **Characterisation and carriage ratio of Clostridium difficile strains isolated from a community-dwelling elderly population in the United Kingdom.** *PLoS One* 2011, **6**:e22804.
49. Ozaki E, Kato H, Kita H, Karasawa T, Maegawa T, Koino Y, Matsumoto K, Takada T, Nomoto K, Tanaka R, Nakamura: **Clostridium difficile colonization in healthy adults: transient colonization and correlation with enterococcal colonization.** *J Med Microbiol* 2004, **53**:167–172.
50. Kato H, Kita H, Karasawa T, Maegawa T, Koino Y, Takakuwa H, Saikai T: **Colonisation and transmission of Clostridium difficile in healthy individuals examined by PCR ribotyping and pulsed-field gel electrophoresis.** *Bact Epidemiol typing* 2001, **50**:720–727.
51. Ziakas PD, Zacharioudakis IM, Zervou FN, Grigoras C, Pliakos EE, Mylonakis E: **Asymptomatic Carriers of Toxigenic C. difficile in Long-Term Care Facilities: A Meta-Analysis of Prevalence and Risk Factors.** *PLoS One* 2015, **10**:e0117195.
52. Riggs MM, Sethi AK, Zabarsky TF, Eckstein EC, Jump RLP, Donskey CJ: **Asymptomatic Carriers Are a Potential Source for Transmission of Epidemic and Nonepidemic Clostridium difficile Strains among Long-Term Care Facility Residents.** *Clin Infect Dis* 2007, **45**:992–998.
53. Laffan AM, Bellantoni MF, Greenough WB, Zenilman JM: **Burden of Clostridium difficile-associated diarrhea in a long-term care facility.** *J Am Geriatr Soc* 2006, **54**:1068–73.
54. European Centre for Disease Prevention and Control: *Point Prevalence Survey of Healthcare-Associated Infections and Antimicrobial Use in European Long-Term Care Facilities - April - May 2013.* Stockholm: European Centre for Disease Prevention and Control; 2013(May).
55. Vestreisdottir I, Gudlaugsdottir S, Einarsdottir R, Kalaitzakis E, Sigurdardottir O, Bjornsson ES: **Risk factors for clostridium difficile toxin-positive diarrhea: A population-based prospective case-control study.** *Eur J Clin Microbiol Infect Dis* 2012, **31**:2601–2610.
56. Walley T, Mantgani a: **The UK General Practice Research Database.** *Lancet* 1997, **350**:1097–1099.
57. Dial S, Delaney J, Barkun A, Suissa S: **Use of Gastric Acid – Suppressive Agents and the Risk of Community-Acquired Clostridium difficile – Associated Disease.** *J Am Med Assoc* 2005, **294**:2989–2995.
58. Centers for Disease Control and Prevention: **Severe Clostridium difficile--Associated Disease in Populations Previously at Low Risk --- Four States, 2005.** *MMWR* 2005, **54**:1201–1205.
59. Centers for Disease Control and Prevention: **Surveillance for Community-Associated Clostridium difficile --- Connecticut, 2006.** *MMWR* 2008, **57**:340–343.
60. Freeman J, Bauer MP, Baines SD, Corver J, Fawley WN, Goorhuis B, Kuijper EJ, Wilcox MH: **The changing epidemiology of Clostridium difficile infections.** *Clin Microbiol Rev* 2010, **23**:529–49.
61. McDonald LC, Coignard B, Dubberke E, Song X, Horan T, Kuty PK: **Recommendations for surveillance of Clostridium difficile-associated disease.** *Infect Control Hosp Epidemiol* 2007, **28**:140–5.

62. Cohen SH, Gerding DN, Johnson S, Kelly CP, Loo VG, McDonald LC, Pepin J, Wilcox MH: **Clinical practice guidelines for Clostridium difficile infection in adults: 2010 update by the society for healthcare epidemiology of America (SHEA) and the infectious diseases society of America (IDSA).** *Infect Control Hosp Epidemiol* 2010, **31**:431–55.
63. Khanna S, Pardi DS, Aronson SL, Kammer PP, Orenstein R, Sauver JLS, Harmsen WS, Zinsmeister AR: **The Epidemiology of Community-Acquired Clostridium difficile Infection : A Population-Based Study.** *Am J Gastroenterol* 2011, **107**:89–95.
64. Wilcox MH, Mooney L, Bendall R, Settle CD, Fawley WN: **A case-control study of community-associated Clostridium difficile infection.** *J Antimicrob Chemother* 2008, **62**:388–96.
65. Karlstrom O, Fryklund B, Tullus K, Burman LG: **A Prospective Nationwide Study of Clostridium difficile – Associated Diarrhea in Sweden.** *Clin Infect Dis* 1998, **26**:141–145.
66. Deshpande A, Pasupuleti V, Thota P, Pant C, Rolston DDK, Sferra TJ, Hernandez A V, Donskey CJ: **Community-associated Clostridium difficile infection and antibiotics : a meta-analysis.** *J Antimicrob Chemother* 2013, **68**:1951–1961.
67. Gould C V, Edwards JR, Cohen J, Bamberg WM, Clark LA, Farley MM, Johnston H, Nadle J, Winston L, Gerding DN: **Effect of Nucleic Acid Amplification Testing on Population-Based Incidence Rates of Clostridium difficile Infection.** *Clin Infect Dis* 2013, **57**:1304–1307.
68. Hensgens MPM, Keessen EC, Squire MM, Riley T V, Koene MGJ, de Boer E, Lipman LJ a, Kuijper EJ: **Clostridium difficile infection in the community: a zoonotic disease?** *Clin Microbiol Infect* 2012:1–11.
69. Lessa FC: **Anaerobe Community-associated Clostridium difficile infection : How real is it ?** *Anaerobe* 2013, **24**:121–123.
70. Lessa F, Yi Mu M, Bamberg W, Beldavs Z, Dumyati G, Dunn J, Farley M, Holzbauer S, Meek J, Phipps EC, Wilson LE, Winston LG, Cohen JA, Limbago BM, Ph D, Fridkin SK, Gerding DN, McDonald LC: **Burden of Clostridium difficile Infection in the United States.** *N Engl J Med* 2015, **372**:825–34.
71. Lambert PJ, Dyck M, Thompson LH, Hammond GW: **Population-based surveillance of Clostridium difficile infection in Manitoba, Canada, by using interim surveillance definitions.** *Infect Control Hosp Epidemiol* 2009, **30**:945–951.
72. Nanwa N, Kendzerska T, Krahn M, Kwong JC, Daneman N, Witteman W, Mittmann N, Cadarette SM, Rosella L, Sander B: **The Economic Impact of Clostridium difficile Infection: A Systematic Review.** *Am J Gastroenterol* 2015, **110**:511–519.
73. Ghantaji SS, Sail K, Lairson DR, DuPont HL, Garey KW: **Economic healthcare costs of Clostridium difficile infection: a systematic review.** *J Hosp Infect* 2010, **74**:309–318.
74. Forster AJ, Taljaard M, Oake N, Wilson KW, Roth V, van Walraven C: **The effect of hospital-acquired infection with Clostridium difficile on length of stay in hospital.** *CMAJ* 2012, **184**:17–8.
75. Mitchell BG, Gardner A, Barnett AG, Hiller JE, Graves N: **The prolongation of length of stay because of Clostridium difficile infection.** *Am J Infect Control* 2013:1–4.

76. Hensgens MPM, Goorhuis A, Dekkers OM, van Benthem BHB, Kuijper EJ: **All-Cause and Disease-Specific Mortality in Hospitalized Patients With Clostridium difficile Infection: A Multicenter Cohort Study.** *Clin Infect Dis* 2013, **56**:1108–16.
77. Mitchell BG, Gardner A: **Prolongation of length of stay and Clostridium difficile infection: a review of the methods used to examine length of stay due to healthcare associated infections.** *Antimicrob Resist Infect Control* 2012, **1**:14.
78. Barnett AG, Beyersmann J, Allignol A, Rosenthal VD, Graves N, Wolkewitz M: **The time-dependent bias and its effect on extra length of stay due to nosocomial infection.** *Value Health*, **14**:381–6.
79. Beyersmann J, Gastmeier P, Grundmann H, Bärwolff S, Geffers C, Behnke M, Rüden H, Schumacher M: **Use of multistate models to assess prolongation of intensive care unit stay due to nosocomial infection.** *Infect Control Hosp Epidemiol* 2006, **27**:493–499.
80. Schulgen G, Schumacher M: **Estimation of prolongation of hospital stay attributable to nosocomial infections: New approaches based on multistate models.** *Lifetime Data Anal* 1996, **2**:219–240.
81. Wolkewitz M, Beyersmann J, Gastmeier P, Schumacher M: **Efficient risk set sampling when a time-dependent exposure is present: matching for time to exposure versus exposure density sampling.** *Methods InfMed* 2009, **48**:438–43.
82. Allignol A, Beyersmann J, Gerds T, Latouche A: **A competing risks approach for nonparametric estimation of transition probabilities in a non-Markov illness-death model.** *Lifetime Data Anal* 2014, **20**:495–513.
83. Schumacher M, Allignol A, Beyersmann J, Binder N, Wolkewitz M: **Hospital-acquired infections--appropriate statistical treatment is urgently needed!** *Int J Epidemiol* 2013, **42**:1502–8.
84. Graves N, Harbarth S, Beyersmann J, Barnett A, Halton K, Cooper B: **Estimating the cost of health care-associated infections: Mind your p's and q's.** *Clin Infect Dis* 2010, **50**:1017–1021.
85. Mulligan ME, Rolfe RD, Finegold M., Lance W: **Contamination of a hospital environment by Clostridium difficile.** *Curr Microbiol* 1980, **3**:173–175.
86. McFarland LV, Mulligan ME, Kwok RYY, Stam WE: **Nosocomial acquisition of Clostridium difficile infection.** *N Engl J Med* 1989, **321**:190.
87. Kim KH, Fekety R, Batts DH, Brown D, Cudmore M, Silva J, Waters D: **Isolation of Clostridium difficile from the environment and contacts of patients with antibiotic-associated colitis.** *J Infect Dis* 1981, **143**:42–50.
88. Shaughnessy MK, Micielli RL, DePestel DD, Arndt J, Strachan CL, Welch KB, Chenoweth CE: **Evaluation of hospital room assignment and acquisition of Clostridium difficile infection.** *Infect Control Hosp Epidemiol* 2011, **32**:201–6.
89. Guerrero DM, Becker JC, Eckstein EC, Kundrapu S, Deshpande a, Sethi a K, Donskey CJ: **Asymptomatic carriage of toxigenic Clostridium difficile by hospitalized patients.** *J Hosp Infect* 2013:2–5.

90. Clabots CR, Johnson S, Olson MM, Peterson LR, Gerding DN: **Acquisition of Clostridium difficile by hospitalized patients: evidence for colonized new admissions as a source of infection.** *J Infect Dis* 1992, **166**:561–7.
91. Walker A, Eyre D, Wyllie D, Dingle K, Harding R, O'Connor L, Griffiths D, Vaughan A, Finney J, Wilcox M, Crook D, Peto T: **Characterisation of Clostridium difficile Hospital Ward-Based Transmission Using Extensive Epidemiological Data and Molecular Typing.** *PLoS Med* 2012, **9**:e1001172.
92. Didelot X, Eyre D, Cule M, Ip C, Ansari A, Griffiths D, Vaughan A, O'Connor L, Golubchik T, Batty E, Piazza P, Wilson D, Bowden R, Donnelly P, Dingle K, Wilcox M, Walker S, Crook D, Peto T, Harding R: **Microevolutionary analysis of Clostridium difficile genomes to investigate transmission.** *Genome Biol* 2012, **13**:R118.
93. Eyre DW, Cule ML, Wilson DJ, Griffiths D, Vaughan A, O'Connor L, Ip CLC, Golubchik T, Batty EM, Finney JM, Wyllie DH, Didelot X, Piazza P, Bowden R, Dingle KE, Harding RM, Crook DW, Wilcox MH, Peto TE a., Walker a. S: **Diverse Sources of C. difficile Infection Identified on Whole-Genome Sequencing.** *N Engl J Med* 2013, **369**:1195–1205.
94. Curry SR, Muto C a, Schlackman JL, Pasculle a W, Shutt K a, Marsh JW, Harrison LH: **Use of multilocus variable number of tandem repeats analysis genotyping to determine the role of asymptomatic carriers in Clostridium difficile transmission.** *Clin Infect Dis* 2013, **57**:1094–102.
95. Mears a, White a, Cookson B, Devine M, Sedgwick J, Phillips E, Jenkinson H, Bardsley M: **Healthcare-associated infection in acute hospitals: which interventions are effective?** *J Hosp Infect* 2009, **71**:307–13.
96. Kaslow DC, Shiver JW: **Clostridium difficile and methicillin-resistant Staphylococcus aureus: emerging concepts in vaccine development.** *Annu Rev Med* 2011, **62**:201–15.
97. Ward SJ, Douce G, Figueiredo D, Dougan G, Wren BW, Al WET, Mmun INI: **Vaccine Expressing a Nontoxic Domain of Clostridium difficile Toxin A.** *Society* 1999, **67**:2145–2152.
98. Ward SJ, Douce G, Dougan G, Wren BW: **Local and systemic neutralizing antibody responses induced by intranasal immunization with the nontoxic binding domain of toxin A from Clostridium difficile.** *Infect Immun* 1999, **67**:5124–32.
99. Torres JF, Lysterly DM, Hill JE: **Evaluation of formalin-inactivated Clostridium difficile vaccines administered by parenteral and mucosal routes of immunization in hamsters . Evaluation of Formalin-Inactivated Clostridium difficile Vaccines Administered by Parenteral and Mucosal Routes o.** *Microbiology* 1995.
100. Greenberg RN, Marbury TC, Foglia G, Warny M: **Phase I dose finding studies of an adjuvanted Clostridium difficile toxoid vaccine.** *Vaccine* 2012, **30**:2245–9.
101. Kotloff KL, Wasserman SS, Genevieve A, Jr WT, Nichols R, Bridwell M, Monath TP, Losonsky GA, Thomas W, Edelman R: **Safety and Immunogenicity of Increasing Doses of a Clostridium difficile Toxoid Vaccine Administered to Healthy Adults Safety and Immunogenicity of Increasing Doses of a Clostridium difficile Toxoid Vaccine Administered to Healthy Adults.** *Infect immunity* 2001.
102. Ghose C: **Clostridium difficile infection in the twenty-first century.** *Emerg Microbes Infect* 2013, **2**:e62.

103. Jit M, Brisson M: **Modelling the Epidemiology of Infectious Diseases for Decision Analysis A Primer**. 2011, **29**:371–386.
104. Anderson RM, May RM: *Infectious Diseases of Humans*. Oxford University Press; 1991.
105. Edmunds WJ, Medley GF, Nokes DJ: **Evaluating the cost-effectiveness of vaccination programmes: a dynamic perspective**. *Stat Med* 1999, **18**:3263–82.
106. Anderson R., May R.: *Infectious Diseases of Humans, Dynamics and Control*. Oxford and New York: Oxford University Press; 1991.
107. Kim S-Y, Goldie SJ: **Cost-effectiveness analyses of vaccination programmes : a focused review of modelling approaches**. *Pharmacoeconomics* 2008, **26**:191–215.
108. Lee BY, Popovich MJ, Tian Y, Bailey RR, Ufberg PJ, Waring AE, Muder RR: **The potential value of Clostridium difficile vaccine: an economic computer simulation model**. *Vaccine* 2010, **28**:5245–53.
109. Safdar N, Perencevich E: **Crossing the quality chasm for Clostridium difficile infection prevention**. *BMJ Qual Saf* 2015:409–411.

CHAPTER 2

MODELLING THE TRANSMISSION OF HEALTHCARE ASSOCIATED INFECTIONS: A SYSTEMATIC REVIEW

2.1 PREAMBLE TO RESEARCH PAPER 1

Chapter 1 explained how mathematical models could be useful tools for quantifying the impact of new or existing intervention strategies. Also highlighted was the limited number of models that investigated *C. difficile* transmission dynamics at the time of initiation of this PhD thesis (three in total). As CDI is most commonly associated with healthcare-settings, it was thought that useful insights could be gained from modelling studies involving other healthcare-associated infections (HCAI). The last review on this subject was published in 2006 [10] and primarily aimed to provide a narrative on how models can improve our understanding of HCAI dynamics and hence aid in hospital infection control, rather than a systematic overview of what models have been published in the field.

Research paper one, by systematically reviewing the literature, firstly, gives an overview of how mathematical models have informed the field of HCAI. Secondly, it presents what methods have been employed and how they have evolved over time, hence providing an overview of the technical developments in this field. Therefore overall, research paper one gives an understanding of the quality of HCAI transmission models, as well as directions for further modelling work to address existing and emerging HCAI related issues all relevant to the ultimate aims of this thesis.

2.2 RESEARCH PAPER 1

Modelling the transmission of healthcare associated infections: a systematic review

E. van Kleef^{1,2}, J.V. Robotham², M. Jit^{1,2}, S.R. Deeny², W.J. Edmunds¹

¹Faculty of Epidemiology and Population Health, Infectious Disease Epidemiology department, Centre of Mathematical Modelling, London School of Hygiene and Tropical Medicine, London, United Kingdom

²Modelling and Economics unit, Public Health England, Colindale, London, United Kingdom

Publication status: published in *BMC infectious diseases*, 2013, doi:10.1186/1471-2334-13-294

RESEARCH PAPER COVER SHEET

PLEASE NOTE THAT A COVER SHEET MUST BE COMPLETED FOR EACH RESEARCH PAPER INCLUDED IN A THESIS.

SECTION A – Student Details

Student	Esther van Kleef
Principal Supervisor	W.J. Edmunds
Thesis Title	Modelling studies of the transmission-dynamics and hospital burden of Clostridium difficile

If the Research Paper has previously been published please complete Section B, if not please move to Section C

SECTION B – Paper already published

Where was the work published?	BMC Infectious Diseases		
When was the work published?	2013		
If the work was published prior to registration for your research degree, give a brief rationale for its inclusion	N/A		
Have you retained the copyright for the work?*	Yes (Open acces)**	Was the work subject to academic peer review?	Yes

**If yes, please attach evidence of retention. If no, or if the work is being included in its published format, please attach evidence of permission from the copyright holder (publisher or other author) to include this work.*



SECTION C – Prepared for publication, but not yet published

Where is the work intended to be published?	
Please list the paper's authors in the intended authorship order:	
Stage of publication	Choose an item.

SECTION D – Multi-authored work

For multi-authored work, give full details of your role in the research included in the paper and in the preparation of the paper. (Attach a further sheet if necessary)	The candidate defined the research question in collaboration with WJE, JVR and MJ. The candidate developed the search strategy in collaboration with JR. The candidate conducted the title-abstract screening, independent from a shared title-abstract screening by MJ, SD and WJE. Full text evaluation was conducted by the candidate,
--	---

	and in case of uncertainty, discussion took place with JR. The candidate extracted the data and performed the analysis. The candidate wrote the first draft of the manuscript, and incorporated each round of comments and suggestions from the co-authors. All authors have read and approved the final manuscript prior to journal submission and agreed on inclusion in the dissertation.
--	--

Student Signature:  _____ **Date:** 19 November 2015
Supervisor Signature:  _____ **Date:** 19 November 2015

****Copyright policy of BMC Infectious Diseases**

All articles published in *BMC Infectious Diseases* are open access, which means the articles are universally and freely available online. In addition, the authors retain copyright of their article, and grant any third party the right to use reproduce and disseminate the article, subject to the terms of our copyright and license agreement. Allowing the authors to retain copyright of their work permits wider distribution of their work on the condition it is correctly attributed to the authors.

<https://www.biomedcentral.com/bmcinfectdis/about/faq/journal-copyright-policy>

Abstract

Background: Dynamic transmission models are increasingly being used to improve our understanding of the epidemiology of healthcare-associated infections (HCAI). However, there has been no recent comprehensive review of this emerging field. This study aimed to summarise how mathematical models have informed the field of HCAI and how methods have developed over time.

Methods: MEDLINE, EMBASE, Scopus, CINAHL plus and Global Health databases were systematically searched for dynamic mathematical models of HCAI transmission and/or the dynamics of antimicrobial resistance in healthcare settings.

Findings: In total, 96 papers met the eligibility criteria. The main research themes considered were evaluation of infection control effectiveness (64%), variability in transmission routes (7%), the impact of movement patterns between healthcare institutes (5%), the development of antimicrobial resistance (3%), and strain competitiveness or co-colonisation with different strains (3%). Methicillin-resistant *Staphylococcus aureus* was the most commonly modelled HCAI (34%), followed by vancomycin resistant enterococci (16%). Other common HCAs, e.g. *Clostridium difficile*, were rarely investigated (3%). Very few models have been published on HCAI from low or middle-income countries. The first HCAI model has looked at antimicrobial resistance in hospital settings using compartmental deterministic approaches. Stochastic models (which include the role of chance in the transmission process) are becoming increasingly common. Model calibration (inference of unknown parameters by fitting models to data) and sensitivity analysis are comparatively uncommon, occurring in 35% and 36% of studies respectively, but their application is increasing. Only 5% of models compared their predictions to external data.

Conclusions: Transmission models have been used to understand complex systems and to predict the impact of control policies. Methods have generally improved, with an increased use of stochastic models, and more advanced methods for formal model fitting and sensitivity analyses. Insights gained from these models could be broadened to a wider range of pathogens and settings. Improvements in the availability of data and statistical methods could enhance the predictive ability of models.

Keywords: mathematical modelling, healthcare-associated infections, epidemiology

Introduction

Health care-associated infections (HCAI) continue to cause a major burden on society, affecting more than 4 million patients annually in Europe alone, and causing an estimated 16 million additional bed-days responsible for €7 billion in direct medical costs [1]. In the United Kingdom, interventions such as improved hand hygiene, antibiotic stewardship and screening combined with decolonisation are believed to have set off a steep reduction in reported incidence of health care-associated methicillin-resistant *Staphylococcus aureus* (MRSA) bacteraemia and *Clostridium difficile* infection with peak incidence in 2003/04 and 2007/08 respectively [2]. Further progress in reducing the burden of HCAI is hindered by uncertainty surrounding the role of asymptomatic carriers [3, 4], environmental transmission [5–7] and the recent emergence of bacteria other than MRSA and *C. difficile*, such as enterobacteriaceae (e.g. *Escherichia coli*) [8]. Mathematical models are increasingly being used to obtain a deeper understanding of epidemiological patterns in hospital infections and to guide hospital infection control policy decisions, as is seen in other areas of infectious disease epidemiology [9].

A previous review of the area provided insight into the type of models used for hospital epidemiology and highlighted their capacity to increase epidemiological understanding, and inform infection control policy [10]. This review, conducted in 2006, primarily aimed to explain the capacities of models and therefore was limited to a detailed description of a number of studies. Hence, the emerging trends in the area were not fully explored. Since 2006 the field has expanded considerably. We conducted a systematic review in order to establish how mathematical models have been applied in the field of HCAI, and how model methods have developed over time.

Methods

We searched Medline (1950 to present), EMBASE (1947 to present), Scopus (1823 to present), CINAHL (1937 to present) and Global health (1910 to present). Results were limited to peer-reviewed publications in English. Search terms and Medical Subject Headings (MeSH) for nosocomial organisms and antibiotic resistance were combined with search and MeSH terms for healthcare settings and mathematical models as follows:

- Nosocomial infections in general (e.g. “*healthcare-associated infection*” or “*hospital-acquired infection*”)
OR
- Nosocomial organisms (e.g. “*C. difficile*” or “*Staphylococcus aureus*”) **OR** Antimicrobial resistance
AND Nosocomial (e.g. “*hospital*” or “*healthcare*”)
AND
- Mathematical modelling or economic evaluation model (e.g. “*stochastic*” or “*deterministic*” **AND** “*model*”)

We decided not to use search terms for nosocomial infection types (e.g. surgical site infections or urinary tract infections), since our review focuses on the transmission of infections from one individual to another, which cannot generally be accurately represented without knowing the causative organism.

The complete search strategy is provided in the supporting material. All databases were searched identically, with exception of the MeSH terms, which were altered to the subject-heading dictionary used in each particular database. The final search was conducted on 11 December 2011. Each title and abstract in the search result was independently screened by EvK and at least one of the other authors. Full text evaluation was conducted by EvK and in case of uncertainty, discussion took place with JR.

Inclusion criteria

Eligible studies had to fulfil the following criteria: 1) mathematical modelling of HCAI transmission and/or the dynamics of antimicrobial resistance; 2) dynamic transmission models only (i.e. a model which tracks the number of individuals (or proportion of a population) carrying or infected with a pathogen over time, while capturing the effect of contact between individuals on transmission [9]); 3) a primary focus on HCAI transmission in healthcare settings.

Exclusion criteria

Studies were excluded if they did not involve: 1) human to human transmission; or did involve 2) within host transmission only; 3) pharmacodynamics and pharmacokinetics of drugs (e.g. the impact of antibiotic exposure, exploring antibiotic tolerance and investigating fitness), 4) animal transmission of HCAI; 5) community transmission of pathogens spread in the healthcare environment as well, where

community spread was the focus of the paper (e.g. Severe Acute Respiratory Syndrome (SARS) epidemics); or 6) literature review without new primary studies. Moreover, no editorials or letters to editors were included, except if a new mathematical model was introduced.

Results

The database search retrieved 2461 unique papers (Figure 5). After screening the titles and abstracts, 302 papers met the inclusion criteria and were thus eligible for full text evaluation. Review of the full text publications resulted in the inclusion of 94 relevant papers based on our selection criteria. An additional two papers were identified via reference screening [11, 12].

Figure 5 PRISMA flowchart

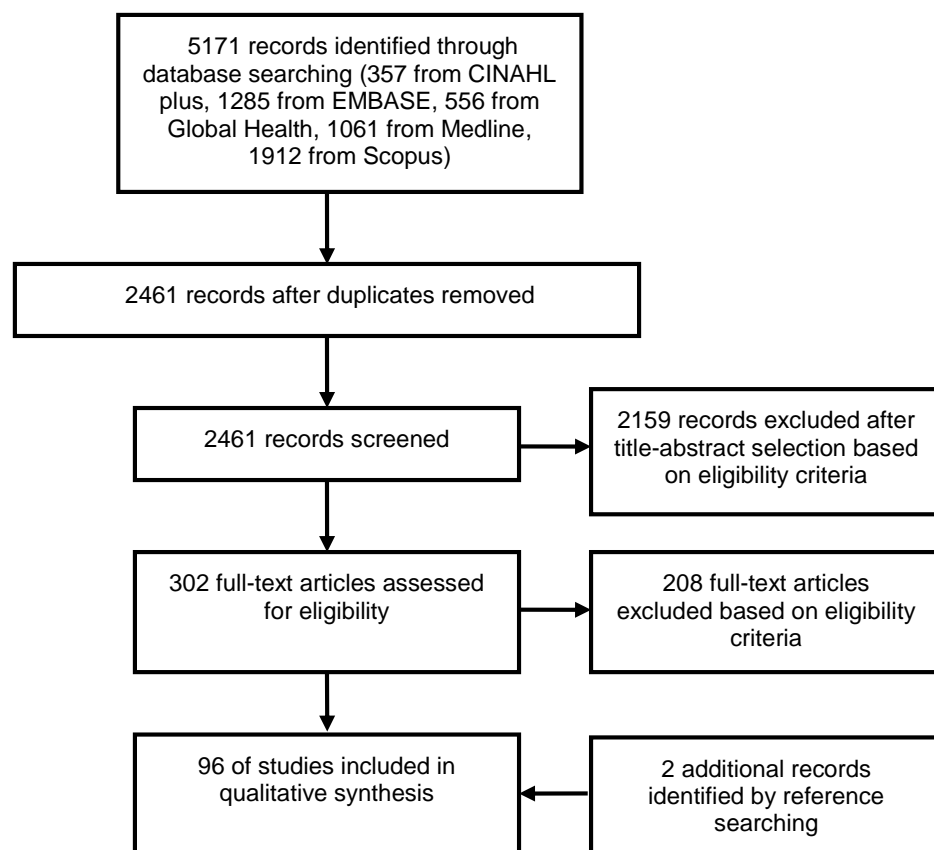

The distribution of these 96 papers over time demonstrates that HCAI transmission models have been increasingly employed since the introduction of the first model of nosocomial pathogens' spread [13] (Figure 6).

Figure 6: Number of HCAI modelling publications over time (1993 – 2011)

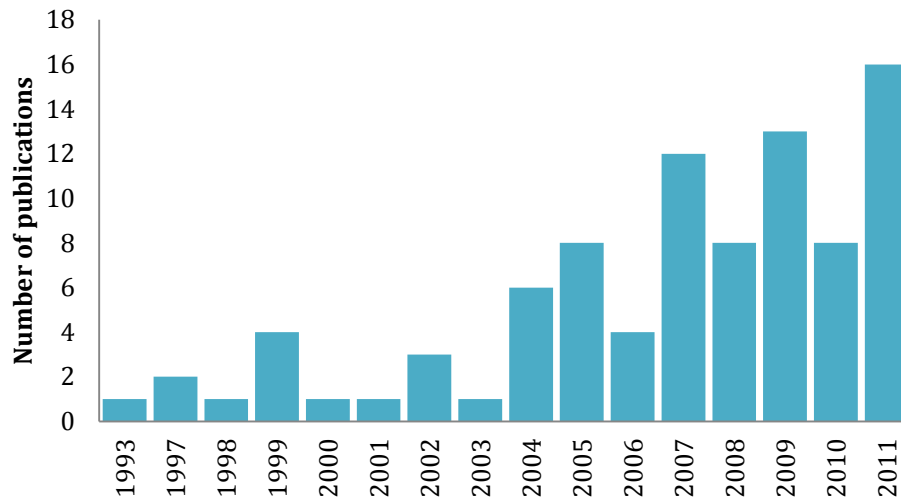

Number of studies identified on modelling of HCAI and antimicrobial resistance spread in a nosocomial setting according to year of publication.

Objectives of mathematical models of HCAIs

Pathogens modelled

Although HCAIs are often associated with antibiotic-resistant bacteria, HCAI models have involved antimicrobial susceptible pathogens as well. In this review, studies that did not specify a particular pathogen of concern, but that claimed to investigate antimicrobial resistant bacteria, were classified as antimicrobial resistant bacteria (ARB). Otherwise, the study was categorised as ‘HCAI in general’. Moreover, as the majority of patients can carry HCAI such as MRSA and *C. difficile* asymptotically, many mathematical models simulate the epidemiology of colonisation, however for brevity we have referred to all models as concerning the epidemiology of HCAI in the text.

Figure 7 shows that MRSA was the most common bacterial species studied (34%; 33 studies) [14–46], followed by Vancomycin-resistant *Enterococcus* (VRE) (or glycopeptide-resistant enterococci) (16%; 15 studies) [12, 18, 28, 31, 47–57] whereas *C. difficile* has rarely been the subject of a model (3%; 3

studies) [58–60]. As several studies investigated the dynamics of more than one pathogen, the total number of infection agents (N=102) listed in Figure 7 exceeds the total number of studies (N=96).

Figure 7: Pathogens modelled in a nosocomial setting (1993 – 2011)

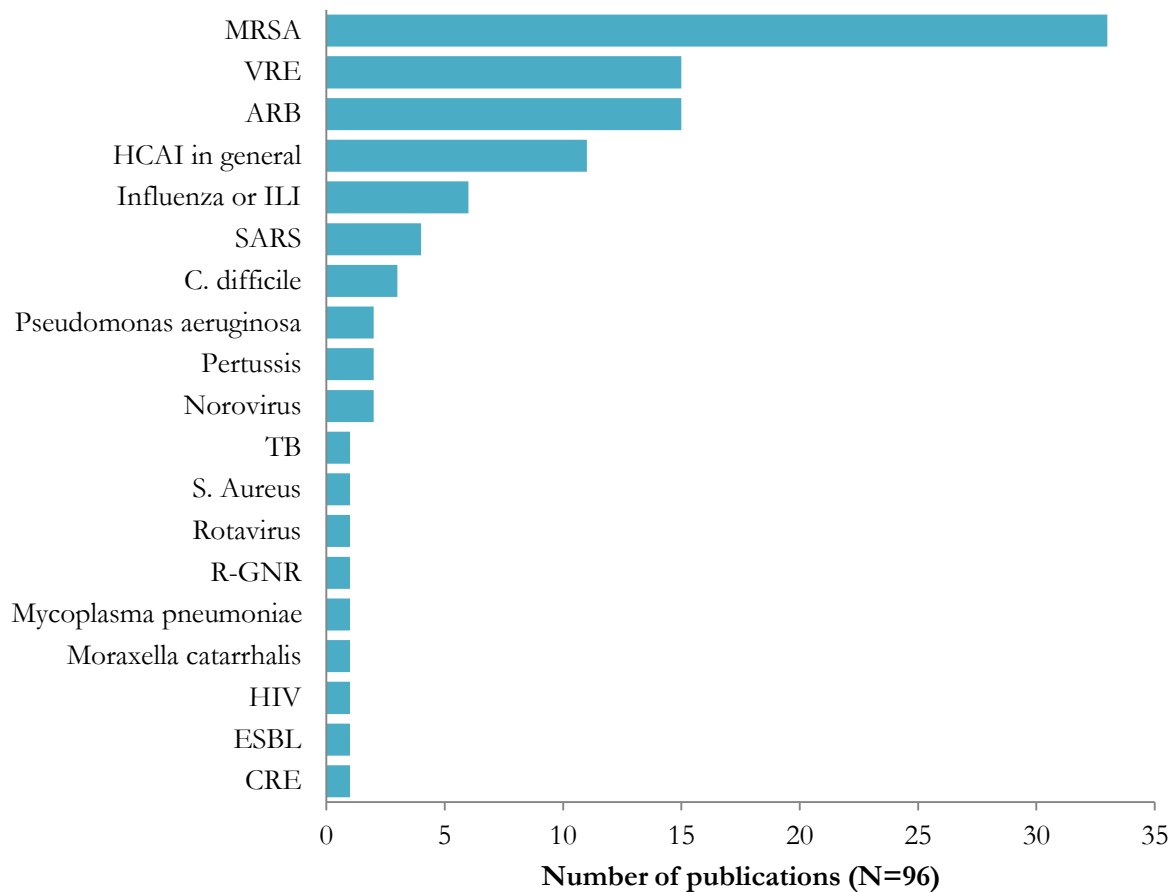

Number of studies identified on nosocomial infection transmission according to pathogen type. MRSA= Methicillin resistant *Staphylococcus aureus*; ARB = Antimicrobial resistant bacteria; VRE = Vancomycin-resistant *Enterococcus*; HCAI = Healthcare associated infections; ILI = Influenza-like illness; SARS = Severe acute respiratory syndrome; TB= Tuberculosis; R-GNR= Third generation cephalosporin-resistant Gram-negative rods; HIV = Human immunodeficiency virus; ESBL = Extended-Spectrum Beta-Lactamases; CRE = cephalosporin-resistant Enterobacteriaceae

Intervention effectiveness

The first model of HCAI conceptualised the spread of antibiotic resistance in bacterial populations among hospital patients [13]. This was soon followed by models evaluating the effectiveness of interventions to reduce antibiotic resistance (e.g. antibiotic cycling or mixing). Since then, most HCAI models have aimed to quantify infection control effectiveness (64%; 62 studies). The infection control measures most frequently considered among these 62 papers have been: hand hygiene (37%; 23 studies),

patient isolation (24%; 15 studies), HCW cohorting (23%; 14 studies), antibiotic stewardship (21%; 13 studies), and screening (18%, 11 studies). Figure 8 provides an overview of the main interventions modelled over time, emphasising that decolonisation and vaccination are more recent subjects of study. Moreover, a wider variability of interventions has been evaluated in the later years. Table 2 illustrates the type of interventions that have been evaluated for each HCAI pathogen.

Figure 8: Main interventions evaluated over time (1993 – 2011)

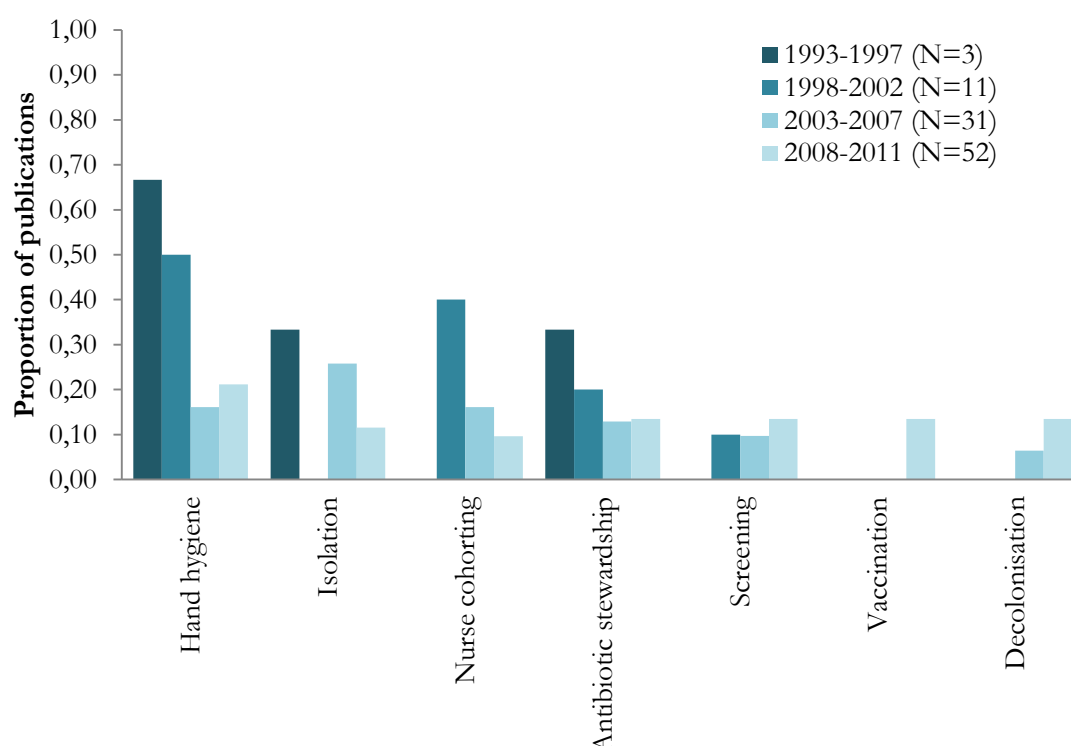

Illustration of the proportionate distribution of the seven most commonly investigated interventions by means of a modelling framework by the total number of publications in each time period.

Table 2: Healthcare infection control interventions evaluated by a modelling framework (1997 – 2011)

Pathogen	Interventions studied	First published	References
MRSA	Hand hygiene	1997	[15–17, 28, 29, 33, 34, 37, 40, 44–46]
	Antibiotic stewardship	1997	[16, 21]
	Isolation	1997	[14, 16, 26, 32, 35, 41, 42, 45]
	HCW cohorting	2002	[17, 29, 40, 44, 45]
	Screening	2005	[14, 23, 25, 32, 34, 39, 44, 45]
	Decolonisation	2009	[14, 25, 26, 33, 34, 40, 45, 46]
	Patient cohorting	2007	[40]
	Gown and glove use	2009	[32]
	Other	2006	[43]
	VRE	Hand hygiene	1998
Antibiotic stewardship		1999	[47, 51, 55]

	Isolation	2004	[12, 52]
	HCW cohorting	1998	[12, 49, 51, 54, 55]
	Screening	2004	[47, 52]
	Decolonisation	2007	[50]
	Patient cohorting	2008	[47]
	Environmental cleaning	2008	[47]
<i>C. difficile</i>	Other	2009	[59]
ARB	Hand hygiene	1997	[92]
	Antibiotic stewardship	1997	[65, 75, 79, 96, 98, 99, 101, 102]
	Barrier precautions (i.e. not specified)	2000	[98]
HCAI in general	Hand hygiene	1999	[86, 123]
	Isolation	2005	[87, 88]
	HCW cohorting	2006	[88, 123]
	Screening	1999	[86]
	Vaccination	2008	[88]
	Barrier precautions (i.e. not specified)	2007	[76]
	Patient cohorting	2005	[87, 124]
	Environmental cleaning	2007	[124]
	Antibiotic prophylaxis	2007	[76]
	Antibiotic stewardship	2008	[103]
	HCW cohorting	2005	[87]
HIV	Sterilization of medical appliances	1999	[97]
Influenza or ILI	Vaccination	2008	[80, 81, 95]
	Prophylaxis	2009	[91]
	Other	2008	[89, 125]
Pertussis	Vaccination	2009	[70, 83]
Rotavirus	Hand hygiene	2011	[78]
	HCW cohorting	2011	[78]
	Vaccination	2011	[78]
SARS	Isolation	2007	[105]
	Barrier precautions (i.e. not specified)	2005	[73]
TB	Isolation	2007	[72]
	HIV treatment	2007	[72]
	Air ventilation	2007	[72]
	Facial mask	2007	[72]

Furthering epidemiological understanding

Models are often used to increase epidemiological understanding. Hospital surveillance data, which is frequently used to inform HCAI models, can lack detail in what is needed for modelling purposes. For example, information on asymptomatic carriage and timing of events (e.g. infection) are often lacking. Several studies use new statistical methods to overcome such difficulties [31, 36, 48] and to allow for estimation of important epidemiological parameters (e.g. transmission rates) from different data sources, varying from routinely collected hospital data [56, 57] to strain typing [61] or genotype data [62]. Others use modelling techniques to determine the relative importance of potential transmission reservoirs

or acquisition routes (of *C. difficile* [58, 60], VRE [50, 53], cephalosporin-resistant Enterobacteriaceae (CRE) [63] and SARS [64]).

The ecological dynamics of pathogens have also been explored using models, including antimicrobial resistance [13, 65, 66]; co-colonisation with different pathogen strain types [27, 46] and competition between strains [24]. Another more recent subject of study is the potential impact of readmission of patients from settings such as long-term care facilities (LTCFs) or the community, as well as general movement patterns between healthcare institutes and/or the community on the transmission of MRSA [19, 25, 38, 67], antimicrobial resistance [68] and HCAI in general [69].

Economic outcomes were not considered in dynamic transmission models until 2011 [14, 23, 70]. Three recent papers applied dynamic modelling techniques to estimate the economic burden of disease (MRSA) [22] and norovirus [67], and to investigate economic incentives for infection control investments [71].

Country of study

A number of studies (36%, 32 studies) did not specify a particular national setting. Of the publications that did; only three studies (3%) explored transmission of HCAI in lower and lower middle income countries [22, 72, 73] and another three looked at upper middle income China [15, 64, 74]. Studies have mainly concentrated on the United States (16%; 15 studies), the United Kingdom (13%; 12 studies) and the Netherlands (10%; 10 studies).

Methods employed for mathematical modelling of HCAs

Stochastic vs. deterministic

The first HCAI models captured transmission dynamics in single wards using deterministic approaches [13, 16]. As the population size in a single ward or hospital is likely to be small, a stochastic modelling approach may often be more appropriate as it can take account of the role of chance in determining transmission patterns. In Table 3, a definition of the modelling terms used for model classification is provided. Figure 9A shows that the proportion of stochastic models has increased steadily over time, and as Figure 10 illustrates, stochasticity was soon introduced (in 1997) [88] after publication of the first (deterministic) HCAI model. Several studies developed both a stochastic and a deterministic

version of a similar compartmental model to investigate whether projected intervention effects were partly a result of random fluctuation [18, 35, 40, 75–77]. Others use a deterministic model to interpret the findings of a stochastic model [78].

Table 3: Definitions of modelling terms

Term	Definition
Deterministic model	A model in which there is no role of chance in the evolution of the states of the system, i.e. the model is ‘predetermined’ by the parameters and initial conditions [121].
Stochastic model	A model in which random (stochastic) processes can affect whether certain events or processes occur (e.g. the rate at which individuals are infected can vary by chance) [121].
Compartmental model	A model in which the population is divided into subgroups (i.e. compartments), which represent the average values of individuals in a particular state (e.g. susceptible, infectious or recovered). Within each compartment, all individuals are homogenous [9].
Individual-based model	A model in which single individuals are tracked rather than subgroups. Hence, each individual can be assigned different characteristics such as the probability of acquiring infection or causing transmission [9].
Model fitting/ model calibration	The inference of unknown parameters by choosing their values in order to approximate a set of data as well as possible. Examples of model fitting methods are least squares approximation maximum likelihood estimation and Markov Chain Monte Carlo Methods [122].
Model validation	Comparison of model predictions to external data, that is a model should be validated against observations from alternative data to the data used for model fitting [122].
Univariate sensitivity analysis	Investigation of uncertainty in model parameters and its impact on model predictions by means of altering one parameter at a time whilst holding others at their base-case value.
Bi/ multivariate sensitivity analysis	Investigation of uncertainty in model parameters by means of alteration of two (or more) parameters at a time whilst holding others at their base-case value.
Probabilistic sensitivity analysis	A type of multivariate sensitivity analysis where multiple runs of the model are performed with random selection of input parameters.
Dynamic transmission model	A model which tracks the number of individuals (or proportion of a population) carrying or infected with a pathogen over time, where the risk of transmission to susceptible at a given point in time is dependent on the number of infected (or colonised) individuals in the community [9].
Static model	A model where the transmission risk is treated as a parameter exogenous to the model, i.e. it does not change with the number of infectious individuals in the population [9].
Force of infection	The rate at which infected individuals become infected per unit time [121]

Compartmental vs. individual-based

Infectious disease models can have either an aggregate (or compartmental) structure (which tracks groups in the population) or an individual-based structure (which tracks individuals). The latter enables better incorporation of heterogeneity in patient characteristics such as patient demographics, contact patterns and disease history, but at the cost of increased computational burden. To date, most (73%; 70 studies) HCAI models have taken an aggregate approach, although the proportion of individual-based models has increased over time (Figure 9A). In total, 26 publications (27%) took an individual-based approach of which seven papers (8%) used both compartmental and individual-based modelling [25, 34, 60, 70, 79–81].

Figure 9: Development of HCAI model structure, and methods used over time

A

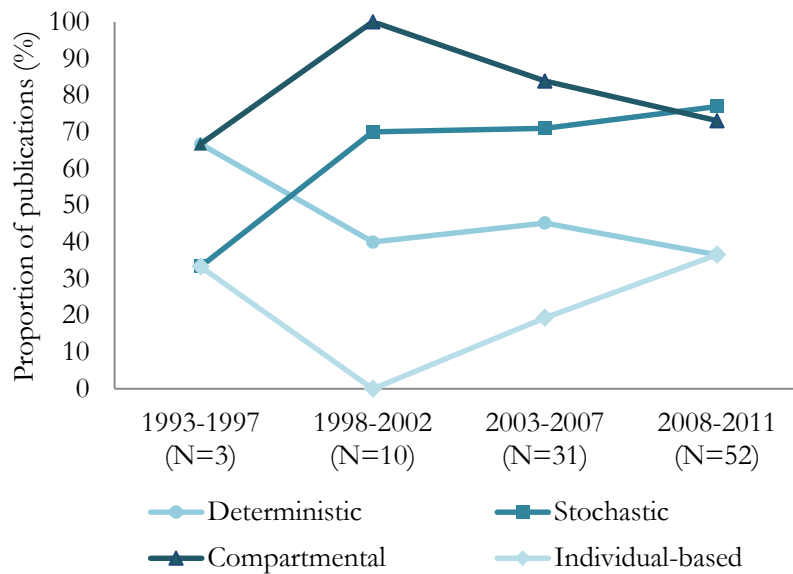

Model approach Proportion of models using a deterministic vs. stochastic and a compartmental vs individual-based modelling approach by the total number of publications in each time period. Note that the categories are not exclusive, i.e. whereas all individual-based models identified are stochastic, compartmental models may be deterministic or stochastic. Moreover, a proportion of studies use a combination of the above listed modelling approaches (e.g. a deterministic compartmental model complemented by a stochastic individual-based model).

B

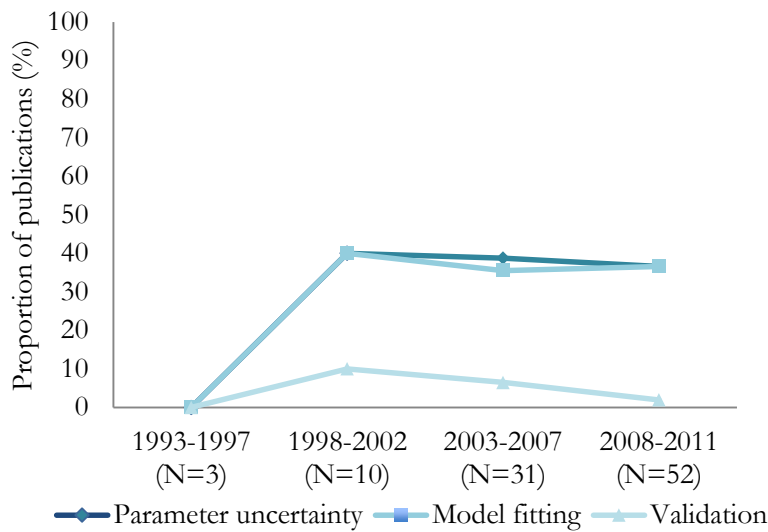

Model methods Proportion of models that are fitted to data, have included uncertainty and are validated by consultation of two different datasets by total number of publications in each time period.

C

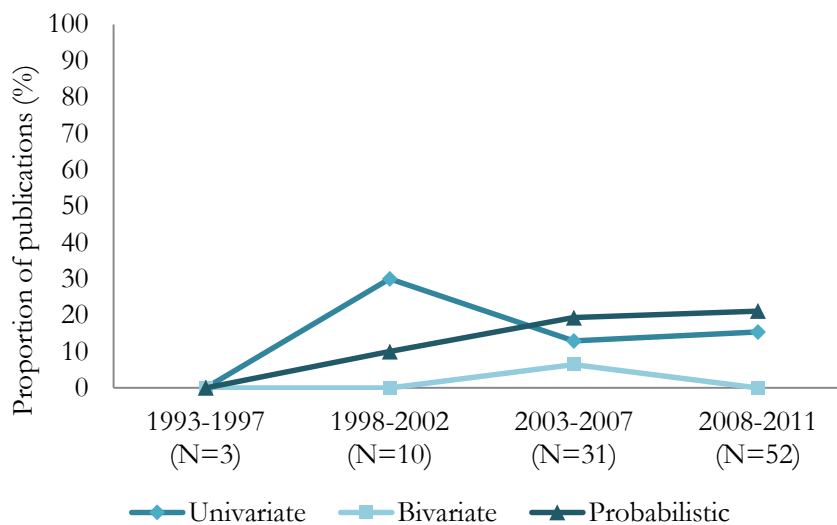

Methods used for characterising parameter uncertainty Proportion of models that have employed uni-variate, vs bi-variate vs probabilistic sensitivity analysis by total number of publications that incorporated parameter uncertainty in each time period.

Model fitting to data

Model parameter values can be based on existing studies, on assumptions, or estimated directly from data [82]. Unknown parameters, such as infection transmission rates, can be inferred by calibrating a model to empirical data. With the increasing availability of computational power, numerically-intensive statistical methods for parameter inference have become more accessible. As Figure 9B shows, although

only 35% (34 studies) of HCAIs models have incorporated some sort of calibration process to empirical data, this proportion has increased over time. Metrics used to quantify goodness of fit include the least square criterion (minimisation of sums of squares between the observed data and the model predictions) [21, 56, 57, 72], maximum likelihood estimation (identification of the parameter value(s) that makes the observed data most likely) [18, 22, 24, 35, 53, 61, 63, 64] and since 2007, Bayesian methods; frequently using Markov Chain Monte Carlo (MCMC) approaches [19, 32, 40, 41, 50, 58, 62, 74] or a combination of MCMC and maximum likelihood estimation [36, 59]. A further seven studies reported fitting their models by comparing model predictions to observed epidemiological data but did not apply any formal quantitative approach [17, 29, 43, 60, 78, 83, 84].

Uncertainty in model predictions

Infectious disease models are developed and informed using a combination of available evidence, for example on infection transmission, disease natural history and intervention effectiveness. As availability of such information is unlikely to be complete, mathematical models inherently include some degree of uncertainty. This uncertainty may relate to model parameter values, model structure (e.g. in terms of disease states incorporated and the relationship between them) or methodology used [9, 85].

Parameter uncertainty was investigated by 36% of the studies (35 publications). As Figure 9B illustrates, similar trends as seen for the application of formal model calibration apply for the inclusion of parameter uncertainty. Also the methods used for parameter uncertainty have become more complex over time (Figure 9C). Of the 35 studies that have investigated parameter uncertainty, univariate sensitivity analysis (i.e. alteration of one parameter at a time whilst holding others at their base-case value) was conducted by 43% (15 studies) [18, 28, 29, 43, 44, 46, 60, 61, 67, 78, 79, 86–89]. The more computationally expensive probabilistic sensitivity analysis (formulation of uncertainty in the model inputs by a joint probability distribution, and propagating this uncertainty to the outputs [90]) is in general considered a rigorous method to account for uncertainty in the joint distribution of the parameters. This was employed by 51% (18 studies) [14, 32, 36, 40–42, 48, 50, 57–59, 62, 72, 74, 75, 80, 81, 91] among which Latin Hypercube Sampling (LHS) as a means of performing probabilistic sensitivity analysis was

conducted by four studies [72, 80, 81, 91]. Probabilistic sensitivity analysis utilizing LHS provides a rigorous method of incorporating and representing real uncertainty surrounding parameter estimates into model-based analysis where joint probability distributions for parameters are available.

Model validation

Model validation is rare in HCAI modelling. Ideally, a model should be validated by means of comparing the model predictions with observations from an alternative dataset than the one used for model fitting, although this is often difficult in practice. Four studies (5%) reported some kind of model validation based on at least two different data sets [50, 53, 72, 83]. However, only one study used a statistical approach [83], whereas the others included subjective comparison of the model predictions (on infection transmission) with genotype data [50, 53, 72].

Setting and interaction between settings

Mathematical models of HCAIs have primarily been set in a single ward (49%, 47 studies), with the intensive care unit (ICU) being the most frequent setting modelled (26%, 25 studies) [14, 16, 22, 28, 29, 31, 32, 36, 40–42, 45, 49, 52, 53, 55, 61, 63, 70, 76, 83, 87, 92–94] or a simplified hospital setting, lacking any further ward structure (31%, 30 studies) [12, 13, 24, 27, 33, 34, 38, 39, 45, 46, 51, 58, 60, 62, 64, 66, 67, 73, 75, 79, 88, 95–103]. More recent studies however, have incorporated the interaction between general wards and the ICU [23, 43, 67] or between different wards [11]. Although these ward or hospital-based models do not usually treat the hospital as a closed system (i.e. hospital admission and discharge rates from and to a 'general community' are frequently included), transfer patterns between healthcare institutes are rarely considered [19, 25, 68, 69, 71, 104], as are transmission dynamics within settings outside the healthcare facilities. The interaction between community and hospital transmission has been included for MRSA [30, 35], antimicrobial resistant bacteria as a whole [65], Severe Acute Respiratory Syndrome [74, 105] and tuberculosis [72]. Hence any possible long-term feedback between the hospital and other settings is not taken into account. Only two models concerned nosocomial transmission in a LTCF setting alone, i.e. of influenza [91] and norovirus [84] respectively.

Figure 10: Milestones of HCAI modelling

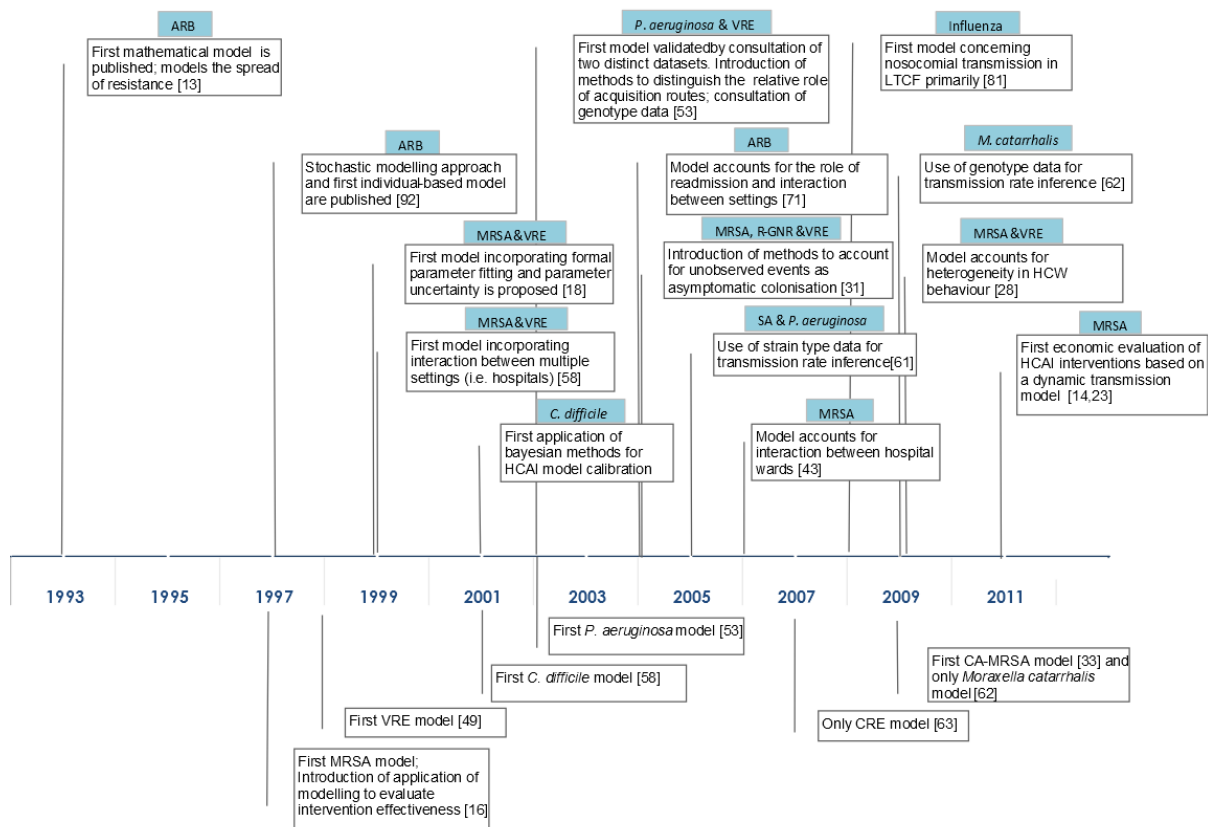

Timeline listing new applications of mathematical models for HCAI and antimicrobial resistance over time as well as improvements of these models according to year of publication.

Discussion

Models of MRSA transmission dominate the literature, followed by VRE, although to a considerably lesser extent. Both have been the subject of national surveillance and infection control policies in a variety of developed countries [106–108]. This may account for the relative abundance of modelling studies. Despite causing a high burden and being the subject of national control policies [109, 110], *C. difficile* transmission has seldom been modelled. Similarly, bloodstream infections due to third-generation cephalosporin-resistant *E. coli*, which have been estimated to cause ~2,700 excess deaths and 120,000 extra bed days in Europe in 2007 have been considered by only one study [63]. For comparison, MRSA was estimated to cause ~5,500 deaths and 256,000 additional bed days in Europe [111], yet has been the subject of over 30 studies. It seems then that the occurrence of models does not necessarily correlate to the burden of disease. This is also true in low and middle income countries, where a recently published systematic review [112, 113] demonstrated significantly higher prevalence of HCAIs than in high income countries; however, very few modelling studies have tackled the problems of HCAI in less developed settings.

In terms of model methods, considerable changes can be identified over time. After the introduction of the first deterministic HCAI modelling study, inclusion of stochasticity has become common practice. The majority of the HCAI models evaluate infection control policies, for which sound model parameterisation and sensitivity analyses are required for reliable predictions. The use of more sophisticated methods for model parameterisation (e.g. MCMC) and uncertainty analysis has become increasingly common.

HCAI models have also increased in complexity regarding the settings modelled. Although the majority of the models have considered a single ward (often ICUs), the apparent emergence of transmission of typical HCAIs in the community, in particular of MRSA [114], have resulted in models which consider the transmission of HCAI from a more holistic approach. As the long-term feedback loop related to hospital discharge and readmission of colonised patients and spread of HCAI pathogens in the community or settings as LTCFs can effect HCAI transmission dynamics [19, 68, 115], such approach can aid in providing a realistic estimate of existing and new infection control strategies' effectiveness.

This review has some limitations. First of all we have exclusively considered peer-reviewed publications in English. This might have resulted in a slight inaccuracy in our results, e.g with regards to the modelling of particular pathogens in alternative national settings. We were exclusively interested in models exploring the patient-to-patient transmission of HCAI and antimicrobial resistance within healthcare settings (either directly, or mediated by healthcare workers and/or the healthcare environment). This has resulted in the exclusion of a higher number of models that elucidate the dynamics of antimicrobial resistance in its own right, which are summarised elsewhere [116, 117]. Moreover, this review intended to provide overall trends in the field of HCAI modelling, rather than a detailed account of the quality of individual models and of what these models have shown, which could be a valid future area of investigation.

Compartmental models (which group individuals in classes) have predominated the field of HCAI modelling. The emergence of individual-based modelling allows for more realistic modelling of healthcare worker-patient contact (e.g. super spreading events) or incorporation of heterogeneity in transmission risk profiles of patients. However, these approaches are computationally far more intensive, are difficult to fit to data, and the inclusion of additional factors makes more demand on the data available. Detailed level data such as observed healthcare worker-patient contact collected for example via mote-based sensor networks, as has been done recently [118], could help parameterise such more complex models.

Moreover, recent technological developments in microbiology have resulted in enhanced access to pathogen sequence data, which could help to further improve HCAI models. Such data are beginning to inform disease outbreaks e.g. of avian influenza A (H7N7) [119] and Foot-and-Mouth disease [120]. Importantly, the increasingly routine use of sequencing of genetic material for epidemiological purposes can provide valuable insight, such as aiding in the understanding of the role of asymptomatic carriers in transmission (e.g. of *C. difficile*) and evolution of antimicrobial resistance.

Conclusions

Transmission models concerning HCAI have showed a general enhancement in complexity, but have been almost completely limited to high-income settings, and have strongly focused on MRSA

transmission in hospital settings. Further improvements in the availability of data and statistical methods could enhance the insight gained from these models.

Competing interest

The authors declare that they have no competing interest

Acknowledgement

The authors are grateful to the referees for their valuable suggestions and advice. This work was supported by the Healthcare Infection Society.

Funding source

This work was supported by the Healthcare Infection Society.

References

1. European Centre of Diseases Control: *Annual Epidemiological Report on Communicable Diseases in Europe 2008: Report on the State of Communicable Diseases in the EU and EEA/EFTA Countries*. Stockholm; 2008.
2. **MRSA and MSSA bacteraemia and C. difficile infection mandatory data (official statistics)** [<http://www.hpa.org.uk/Topics/InfectiousDiseases/InfectionsAZ/HCAI/LatestPublicationsFromMandatorySurveillanceMRSACDIAndGRE/>]
3. Walker a S, Eyre DW, Wyllie DH, Dingle KE, Harding RM, O'Connor L, Griffiths D, Vaughan A, Finney J, Wilcox MH, Crook DW, Peto TE a: **Characterisation of Clostridium difficile Hospital Ward-Based Transmission Using Extensive Epidemiological Data and Molecular Typing**. *PLoS medicine* 2012, **9**:e1001172.
4. Riggs MM, Sethi AK, Zabarsky TF, Eckstein EC, Jump RLP, Donskey CJ: **Asymptomatic Carriers Are a Potential Source for Transmission of Epidemic and Nonepidemic Clostridium difficile Strains among Long-Term Care Facility Residents**. *Clinical Infectious Diseases* 2007, **44**:106.
5. Hensgens MPM, Keessen EC, Squire MM, Riley T V, Koene MGJ, de Boer E, Lipman LJ a, Kuijper EJ: **Clostridium difficile infection in the community: a zoonotic disease?** *Clinical microbiology and infection* 2012:1–11.
6. Khanna S, Pardi DS, Aronson SL, Kammer PP, Orenstein R, Sauver JLS, Harmsen WS, Zinsmeister AR: **The Epidemiology of Community-Acquired Clostridium difficile Infection : A Population-Based Study**. *The American Journal of Gastroenterology* 2011, **107**:89–95.
7. Braga TM, Pomba C, Lopes MFS: **High-level vancomycin resistant Enterococcus faecium related to humans and pigs found in dust from pig breeding facilities**. *Veterinary microbiology* 2012, **Article in.**
8. Health Protection Agency: *English National Point Prevalence Survey on Healthcare-associated Infections and Antimicrobial Use, 2011 - Preliminary Data*. London; 2011:1–140.
9. Jit M, Brisson M: **Modelling the Epidemiology of Infectious Diseases for Decision Analysis A Primer**. 2011, **29**:371–386.
10. Grundmann H, Hellriegel B: **Mathematical modelling: a tool for hospital infection control**. *The Lancet infectious diseases* 2006, **6**:39–45.
11. Ancel Meyers L, Newman MEJ, Martin M, Schrag S: **Applying network theory to epidemics: control measures for Mycoplasma pneumoniae outbreaks**. *Emerging infectious diseases* 2003, **9**:204–10.
12. McBryde E., McElwain DLS: **A mathematic model investigating the impact of an environmental reservoir on the prevalence and control of vancomycin-resistant enterococci**. *The Journal of infectious diseases* 2006, **193**:1473–1474.
13. Massad E, Lundberg S, Yang HM: **Modeling and simulating the evolution of resistance against antibiotics**. *International Journal of Bio-Medical Computing* 1993, **33**:65–81.
14. Robotham J V, Graves N, Cookson BD, Barnett AG, Wilson JA, Edgeworth JD, Batra R, Cuthbertson BH, Cooper BS: **Screening, isolation, and decolonisation strategies in the control of meticillin resistant Staphylococcus aureus in intensive care units: Cost effectiveness evaluation**. *BMJ* 2011, **343**.

15. Wang J, Wang L, Magal P, Wang Y, Zhuo J, Lu X, Ruan S: **Modelling the transmission dynamics of methicillin-resistant *Staphylococcus aureus* in Beijing Tongren hospital.** *Journal of Hospital Infection* 2011, **79**:302–308.
16. Seville V, Chevret S, Valleron A: **Modeling the spread of resistant nosocomial pathogens in an intensive-care unit.** *Infection Control & Hospital Epidemiology* 1997, **18**:84–92.
17. Milazzo L, Bown JL, Eberst A, Phillips G, Crawford JW: **Modelling of Healthcare Associated Infections: A study on the dynamics of pathogen transmission by using an individual-based approach.** *Computer Methods and Programs in Biomedicine* 2011, **104**:260–265.
18. Austin DJ, Anderson RM: **Transmission dynamics of epidemic methicillin-resistant *Staphylococcus aureus* and vancomycin-resistant enterococci in England and Wales.** *Journal of Infections Diseases* 1999, **179**:883–891.
19. Lesosky M, McGeer A, Simor A, Green K, Low DE, Raboud J: **Effect of patterns of transferring patients among healthcare institutions on rates of nosocomial methicillin-resistant *Staphylococcus aureus* transmission: a Monte Carlo simulation.** *Infection Control & Hospital Epidemiology* 2011, **32**:136–147.
20. Lee BY, McGlone SM, Wong KF, Yilmaz SL, Avery TR, Song Y, Christie R, Eubank S, Brown ST, Epstein JM, Parker JI, Burke DS, Platt R, Huang SS: **Modeling the spread of methicillin-resistant staphylococcus aureus (mrsa) outbreaks throughout the hospitals in orange county, California.** *Infection Control & Hospital Epidemiology* 2011, **32**:562–572.
21. Kardas-Sloma L, Boelle PY, Opatowski L, Brun-Buisson C, Guillemot D, Temime L: **Impact of antibiotic exposure patterns on selection of community-associated methicillin-resistant *Staphylococcus aureus* in hospital settings.** *Antimicrobial Agents and Chemotherapy* 2011, **55**:4888–4895.
22. Christopher S, Verghis RM, Antonisamy B, Sowmyanarayanan T V, Brahmadathan KN, Kang G, Cooper BS: **Transmission dynamics of methicillin-resistant *Staphylococcus aureus* in a medical intensive care unit in India.** *PLoS ONE [Electronic Resource]* 2011, **6**.
23. Hubben G, Bootsma M, Luteijn M, Glynn D, Bishai D, Bonten M, Postma M: **Modelling the costs and effects of selective and universal hospital admission screening for methicillin-resistant *Staphylococcus aureus*.** *PLoS ONE [Electronic Resource]* 2011, **6**:e14783.
24. Bootsma MCJ, Wassenberg MWM, Trapman P, Bonten MJM: **The nosocomial transmission rate of animal-associated ST398 methicillin-resistant *Staphylococcus aureus*.** *Journal of the Royal Society Interface* 2011, **8**:578–584.
25. Barnes SL, Harris AD, Golden BL, Wasil EA, Furuno JP: **Contribution of interfacility patient movement to overall methicillin-resistant *Staphylococcus aureus* prevalence levels.** *Infection Control and Hospital Epidemiology* 2011, **32**:1073–1078.
26. Meng Y, Davies R, Hardy K, Hawkey P: **An application of agent-based simulation to the management of hospital-acquired infection.** *Journal of Simulation* 2010, **4**:60–67.
27. Pressley J, D'Agata EMC, Webb GF: **The effect of co-colonization with community-acquired and hospital-acquired methicillin-resistant *Staphylococcus aureus* strains on competitive exclusion.** *Journal of Theoretical Biology* 2010, **264**:645–656.

28. Temime L, Opatowski L, Pannet Y, Brun-Buisson C, Boelle PY, Guillemot D: **Peripatetic health-care workers as potential superspreaders.** *Proceedings of the National Academy of Sciences of the United States of America* 2009, **106**:18420–18425.
29. Grundmann H, Hori S, Winter B, Tami A, Austin DJ: **Risk factors for the transmission of methicillin-resistant *Staphylococcus aureus* in an adult intensive care unit: fitting a model to the data.** *Journal of Infectious Diseases* 2002, **185**:481–488.
30. Skov RL, Jensen KS: **Community-associated methicillin-resistant *Staphylococcus aureus* as a cause of hospital-acquired infections.** *Journal of Hospital Infection* 2009, **73**:364–370.
31. Cooper B, Lipsitch M: **The analysis of hospital infection data using hidden Markov models.** *Biostatistics* 2004, **5**:223–237.
32. Kypraios T, O'Neill PD, Huang SS, Rifas-Shiman SL, Cooper BS: **Assessing the role of undetected colonization and isolation precautions in reducing Methicillin-Resistant *Staphylococcus aureus* transmission in intensive care units.** *BMC Infectious Diseases* 2009, **10**.
33. Webb GF, Horn MA, D'Agata EMCD, Moellering RC, Ruan S: **Competition of hospital-acquired and community-acquired methicillin-resistant *Staphylococcus aureus* strains in hospitals.** *Journal of Biological Dynamics* 2010, **1**:115–129.
34. D'Agata EMC, Webb GF, Horn MA, Moellering Jr RC, Ruan S: **Modeling the invasion of community-acquired methicillin-resistant *Staphylococcus aureus* into hospitals.** *Clinical Infectious Diseases* 2009, **48**:274–284.
35. Cooper BS, Medley GF, Stone SP, Kibbler CC, Cookson BD, Roberts JA, Duckworth G, Lai R, Ebrahim S: **Methicillin-resistant *Staphylococcus aureus* in hospitals and the community: stealth dynamics and control catastrophes.** *Proceedings of the National Academy of Sciences of the United States of America* 2004, **101**:10223–10228.
36. Drovandi CC, Pettitt AN: **Multivariate Markov process models for the transmission of methicillin-resistant *Staphylococcus aureus* in a hospital ward.** *Biometrics* 2008, **64**:851–859.
37. Beggs CB, Shepherd SJ, Kerr KG: **Increasing the frequency of hand washing by healthcare workers does not lead to commensurate reductions in staphylococcal infection in a hospital ward.** *BMC Infectious Diseases* 2008, **8**:114.
38. Robotham J V, Scarff CA, Jenkins DR, Medley GF: **Meticillin-resistant *Staphylococcus aureus* (MRSA) in hospitals and the community: model predictions based on the UK situation.** *Journal of Hospital Infection* 2007, **65 Suppl 2**:93–99.
39. Robotham J V, Jenkins DR, Medley GF: **Screening strategies in surveillance and control of methicillin-resistant *Staphylococcus aureus* (MRSA).** *Epidemiology & Infection* 2007, **135**:328–342.
40. McBryde ES, Pettitt AN, McElwain DLS: **A stochastic mathematical model of methicillin resistant *Staphylococcus aureus* transmission in an intensive care unit: predicting the impact of interventions.** *Journal of Theoretical Biology* 2007, **245**:470–481.
41. Forrester ML, Pettitt AN, Gibson GJ: **Bayesian inference of hospital-acquired infectious diseases and control measures given imperfect surveillance data.** *Biostatistics* 2007, **8**:383–401.

42. Forrester M, Pettitt AN: **Use of stochastic epidemic modeling to quantify transmission rates of colonization with methicillin-resistant Staphylococcus aureus in an intensive care unit.** *Infection Control & Hospital Epidemiology* 2005, **26**:598–606.
43. Bootsma MCJ, Diekmann O, Bonten MJM: **Controlling methicillin-resistant Staphylococcus aureus: quantifying the effects of interventions and rapid diagnostic testing.** *Proceedings of the National Academy of Sciences of the United States of America* 2006, **103**:5620–5625.
44. Raboud J, Saskin R, Simor A, Loeb M, Green K, Low DE, McGeer A: **Modeling transmission of methicillin-resistant Staphylococcus aureus among patients admitted to a hospital.** *Infection Control & Hospital Epidemiology* 2005, **26**:607–615.
45. Barnes S, Golden B, Wasil E: **MRSA transmission reduction using agent-based modeling and simulation.** *INFORMS Journal on Computing* 2010, **22**:635–646.
46. D’Agata EMC, Webb GF, Pressley J: **Rapid emergence of co-colonization with community-acquired and hospital-acquired methicillin-resistant Staphylococcus aureus strains in the hospital setting.** *Mathematical Modelling of Natural Phenomena* 2010, **5**:76–93.
47. Wolkewitz M, Dettenkofer M, Bertz H, Schumacher M, Huebner J: **Environmental contamination as an important route for the transmission of the hospital pathogen VRE: modeling and prediction of classical interventions.** *Infectious Diseases: Research and Treatment* 2008, **1**:3–11.
48. Cooper BS, Medley GF, Bradley SJ, Scott GM: **An augmented data method for the analysis of nosocomial infection data.** *American Journal of Epidemiology* 2008, **168**:548–557.
49. Austin DJ, Bonten MJM: **Vancomycin-resistant enterococci in intensive care hospital settings.** *Memorias do Instituto Oswaldo Cruz* 1998, **93**:587–588.
50. McBryde ES, Pettitt AN, Cooper BS, McElwain DLS: **Characterizing an outbreak of vancomycin-resistant enterococci using hidden Markov models.** *Journal of the Royal Society Interface* 2007, **4**:745–754.
51. D’Agata EMC, Webb G, Horn M: **A mathematical model quantifying the impact of antibiotic exposure and other interventions on the endemic prevalence of vancomycin-resistant enterococci.** *Journal of Infectious Diseases* 2005, **192**:2004–2011.
52. Perencevich EN, Fisman DN, Lipsitch M, Harris AD, Morris Jr. JG, Smith DL: **Projected benefits of active surveillance for vancomycin-resistant enterococci in intensive care units.** *Clinical Infectious Diseases* 2004, **38**:1108–1115.
53. Pelupessy I, Bonten MJM, Diekmann O: **How to assess the relative importance of different colonization routes of pathogens within hospital settings.** *Proceedings of the National Academy of Sciences of the United States of America* 2002, **99**:5601–5605.
54. D’Agata EMC, Horn MA, Webb GF: **The impact of persistent gastrointestinal colonization on the transmission dynamics of vancomycin-resistant enterococci.** *Journal of Infectious Diseases* 2002, **185**:766–773.
55. Austin DJ, Bonten MJ, Weinstein RA, Slaughter S, Anderson RM: **Vancomycin-resistant enterococci in intensive-care hospital settings: transmission dynamics, persistence, and the impact of infection control programs.** *Proceedings of the National Academy of Sciences of the United States of America* 1999, **96**:6908–6913.

56. Ortiz A, Banks HT, Castillo-Chavez C, Chowell G, Wang X: **A discrete events delay differential system model for transmission of Vancomycin-resistant enterococcus (VRE) in hospitals.** *Journal of Inverse and Ill-Posed Problems* 2010, **18**:787–821.
57. Ortiz AR, Banks HT, Castillo-Chavez C, Chowell G, Wang X: **A deterministic methodology for estimation of parameters in dynamic markov chain models.** *Journal of Biological Systems* 2011, **19**:71–100.
58. Starr JM, Campbell A: **Mathematical modeling of Clostridium difficile infection.** *Clinical Microbiology & Infection* 2001, **7**:432–437.
59. Starr JM, Campbell A, Renshaw E, Poxton IR, Gibson GJ: **Spatio-temporal stochastic modelling of Clostridium difficile.** *Journal of Hospital Infection* 2009, **71**:49–56.
60. Lanzas C, Dubberke ER, Lu Z, Reske KA, Grohn YT: **Epidemiological model for Clostridium difficile transmission in healthcare settings.** *Infection Control & Hospital Epidemiology* 2011, **32**:553–561.
61. Jackson BR, Thomas A, Carroll KC, Adler FR, Samore MH: **Use of strain typing data to estimate bacterial transmission rates in healthcare settings.** *Infection Control & Hospital Epidemiology* 2005, **26**:638–645.
62. Leman SC, Levy F, Walker ES: **Modeling the spread of infectious disease using genetic information within a marked branching process.** *Statistics in Medicine* 2009, **28**:3626–3642.
63. Bootsma MCJ, Bonten MJM, Nijssen S, Fluit a C, Diekmann O: **An algorithm to estimate the importance of bacterial acquisition routes in hospital settings.** *American journal of epidemiology* 2007, **166**:841–51.
64. Kwok KO, Leung GM, Lam WY, Riley S: **Using models to identify routes of nosocomial infection: a large hospital outbreak of SARS in Hong Kong.** *Proceedings of the Royal Society of London - Series B: Biological Sciences* 2007, **274**:611–617.
65. Kouyos RD, Abel Zur Wiesch P, Bonhoeffer S: **On being the right size: the impact of population size and stochastic effects on the evolution of drug resistance in hospitals and the community.** *PLoS Pathogens* 2011, **7**:e1001334.
66. Webb GF, D'Agata EMC, Magal P, Ruan S: **A model of antibiotic-resistant bacterial epidemics in hospitals.** *Proceedings of the National Academy of Sciences of the United States of America* 2005, **102**:13343–13348.
67. Lee BY, McGlone SM, Bailey RR, Wettstein ZS, Umscheid CA, Muder RR: **Economic impact of outbreaks of norovirus infection in hospitals.** *Infection Control & Hospital Epidemiology* 2011, **32**:191–193.
68. Smith DL, Dushoff J, Perencevich EN, Harris AD, Levin SA: **Persistent colonization and the spread of antibiotic resistance in nosocomial pathogens: Resistance is a regional problem.** *Proceedings of the National Academy of Sciences of the United States of America* 2004, **101**:3709–3714.
69. Donker T, Wallinga J, Grundmann H: **Patient referral patterns and the spread of hospital-acquired infections through national health care networks.** *PLoS Computational Biology* 2010, **6**:e1000715.
70. Greer AL, Fisman DN: **Use of models to identify cost-effective interventions: Pertussis vaccination for pediatric health care workers.** *Pediatrics* 2011, **128**:e591–e599.

71. Smith DL, Levin SA, Laxminarayan R: **Strategic interactions in multi-institutional epidemics of antibiotic resistance.** *Proceedings of the National Academy of Sciences of the United States of America* 2005, **102**:3153–3158.
72. Basu S, Andrews JR, Poolman EM, Gandhi NR, Shah NS, Moll A, Moodley P, Galvani AP, Friedland GH: **Prevention of nosocomial transmission of extensively drug-resistant tuberculosis in rural South African district hospitals: an epidemiological modelling study.** *Lancet* 2007, **370**:1500–1507.
73. Nishiura H, Kuratsuji T, Quy T, Phi NC, Van Ban V, Ha LD, Long HT, Yanai H, Keicho N, Kirikae T, Sasazuki T, Anderson RM: **Rapid awareness and transmission of severe acute respiratory syndrome in Hanoi French Hospital, Vietnam.** *American Journal of Tropical Medicine and Hygiene* 2005, **73**:17–25.
74. Cori A, Boelle PY, Thomas G, Leung GM, Valleron AJ: **Temporal variability and social heterogeneity in disease transmission: the case of SARS in Hong Kong.** *PLoS Computational Biology* 2009, **5**:e1000471.
75. Bergstrom CT, Lo M, Lipsitch M: **Ecological theory suggests that antimicrobial cycling will not reduce antimicrobial resistance in hospitals.** *Proceedings of the National Academy of Sciences of the United States of America* 2004, **101**:13285–13290.
76. Boldin B, Bonten MJM, Diekmann O: **Relative effects of barrier precautions and topical antibiotics on nosocomial bacterial transmission: results of multi-compartment models.** *Bulletin of Mathematical Biology* 2007, **69**:2227–2248.
77. Kouyos RD, Abel Zur Wiesch P, Bonhoeffer S: **Informed switching strongly decreases the prevalence of antibiotic resistance in hospital wards.** *PLoS Computational Biology* 2011, **7**:e1001094.
78. Kribs-Zaleta CM, Jusot JF, Vanhems P, Charles S: **Modeling Nosocomial Transmission of Rotavirus in Pediatric Wards.** *Bulletin of Mathematical Biology* 2011, **73**:1413–1442.
79. Haber MJ, Levin BR, Kramarz P: **Antibiotic control of antibiotic resistance in hospitals: a simulation study.** *BMC Infectious Diseases* 2010, **10**:(25 August 2010).
80. van den Dool C, Bonten MJM, Hak E, Wallinga J: **Modeling the effects of influenza vaccination of health care workers in hospital departments.** *Vaccine* 2009, **27**:6261–6267.
81. van den Dool C, Bonten MJM, Hak E, Heijne JCM, Wallinga J: **The effects of influenza vaccination of health care workers in nursing homes: insights from a mathematical model.** *PLoS Medicine / Public Library of Science* 2008, **5**:e200.
82. O'Neill PD: **Introduction and snapshot review: relating infectious disease transmission models to data.** *Statistics in medicine* 2010, **29**:2069–77.
83. Greer AL, Fisman DN: **Keeping vulnerable children safe from pertussis: preventing nosocomial pertussis transmission in the neonatal intensive care unit.** *Infection Control & Hospital Epidemiology* 2009, **30**:1084–1089.
84. Vanderpas J, Louis J, Reynders M, Mascart G, Vandenberg O: **Mathematical model for the control of nosocomial norovirus.** *Journal of Hospital Infection* 2009, **71**:214–222.
85. Bilcke J, Beutels P, Brisson M, Jit M: **Accounting for methodological, structural, and parameter uncertainty in decision-analytic models: a practical guide.** *Medical decision making: an international journal of the Society for Medical Decision Making* 2011, **31**:675–92.

86. Cooper BS, Medley GF, Scott GM: **Preliminary analysis of the transmission dynamics of nosocomial infections: stochastic and management effects.** *Journal of Hospital Infection* 1999, **43**:131–147.
87. Hotchkiss JR, Strike DG, Simonson DA, Broccard AF, Crooke PS: **An agent-based and spatially explicit model of pathogen dissemination in the intensive care unit.** *Critical Care Medicine* 2005, **33**:164–168.
88. Ueno T, Masuda N: **Controlling nosocomial infection based on structure of hospital social networks.** *Journal of Theoretical Biology* 2008, **254**:655–666.
89. Laskowski M, Demianyk BCP, Witt J, Mukhi SN, Friesen MR, McLeod RD: **Agent-based modeling of the spread of influenza-like illness in an emergency department: a simulation study.** *IEEE transactions on information technology in biomedicine : a publication of the IEEE Engineering in Medicine and Biology Society* 2011, **15**:877–89.
90. Oakley JE, Hagan AO: **Probabilistic sensitivity analysis of complex models : a Bayesian approach.** 2004:751–769.
91. van den Dool C, Hak E, Bonten MJM, Wallinga J: **A model-based assessment of oseltamivir prophylaxis strategies to prevent influenza in nursing homes.** *Emerging Infectious Diseases* 2009, **15**:1547–1555.
92. Sebillé V, Valleron AJ: **A computer simulation model for the spread of nosocomial infections caused by multidrug-resistant pathogens.** *Computers & Biomedical Research* 1997, **30**:307–322.
93. Artalejo JR, Economou A, Lopez-Herrero MJ: **On the number of recovered individuals in the SIS and SIR stochastic epidemic models.** *Mathematical Biosciences* 2010, **228**:45–55.
94. Beardmore RE, Pena-Miller R: **Rotating antibiotics selects optimally against antibiotic resistance, in theory.** *Mathematical Biosciences & Engineering: MBE* 2010, **7**:527–552.
95. Polgreen PM, Tassier TL, Pemmaraju S V, Segre AM: **Prioritizing healthcare worker vaccinations on the basis of social network analysis.** *Infection Control & Hospital Epidemiology* 2010, **31**:893–900.
96. Friedman A, Ziyadi N, Boushaba K: **A model of drug resistance with infection by health care workers.** *Mathematical Biosciences & Engineering: MBE* 2010, **7**:779–792.
97. Bakhir VM, Grishin VP, Panicheva SA, Toloknov VI: **Assessment of the effectiveness of medical instruments sterilization by electrochemically activated solutions and computer modeling of the dynamics of hospital infections. [Russian] Otsenka effektivnosti sterilizatsii meditsinskogo instrumentarii elektro.** *Meditsinskaya Tekhnika* 1999:14–16.
98. Lipsitch M, Bergstrom CT, Levin BR: **The epidemiology of antibiotic resistance in hospitals: paradoxes and prescriptions.** *Proceedings of the National Academy of Sciences of the United States of America* 2000, **97**:1938–1943.
99. D'Agata EMC, Magal P, Olivier D, Ruan S, Webb GF: **Modeling antibiotic resistance in hospitals: the impact of minimizing treatment duration.** *Journal of Theoretical Biology* 2007, **249**:487–499.
100. Noakes CJ, Beggs CB, Sleigh PA, Kerr KG: **Modelling the transmission of airborne infections in enclosed spaces.** *Epidemiology & Infection* 2006, **134**:1082–1091.

101. Reluga TC: **Simple models of antibiotic cycling.** *Mathematical Medicine & Biology* 2005, **22**:187–208.
102. Chowa K, Wanga X, Curtiss R, Castillo-Chavez C: **Evaluating the efficacy of antimicrobial cycling programmes and patient isolation on dual resistance in hospitals.** *Journal of Biological Dynamics* 2011, **5**:27–43.
103. Massad E, Burattini MN, Coutinho FAB: **An optimization model for antibiotic use.** *Applied Mathematics and Computation* 2008, **201**:161–167.
104. Lee BY, McGlone SM, Wong KF, Yilmaz SL, Avery TR, Song Y, Christie R, Eubank S, Brown ST, Epstein JM, Parker JI, Burke DS, Platt R, Huang SS: **Modeling the spread of methicillin-resistant staphylococcus aureus (mrsa) outbreaks throughout the hospitals in orange county, California.** *Infection Control & Hospital Epidemiology* 2011, **32**:562–572.
105. Fukutome A, Watashi K, Kawakami N, Ishikawa H: **Mathematical modeling of severe acute respiratory syndrome nosocomial transmission in Japan: the dynamics of incident cases and prevalent cases.** *Microbiology & Immunology* 2007, **51**:823–832.
106. Köck R, Becker K, Cookson B, van Gemert-Pijnen JE, Harbarth S, Kluytmans J, Mielke M, Peters G, Skov RL, Struelens MJ, Tacconelli E, Navarro Torné a, Witte W, Friedrich a W: **Methicillin-resistant Staphylococcus aureus (MRSA): burden of disease and control challenges in Europe.** *Euro surveillance : bulletin européen sur les maladies transmissibles = European communicable disease bulletin* 2010, **15**:19688.
107. **MRSA surveillance** [<http://www.cdc.gov/mrsa/statistics/mrsa-surveillance-summary.html>]
108. **Surveillance for Methicillin-resistant Staphylococcus aureus (MRSA) in Patients Hospitalized in Canadian Acute-Care Hospitals Participating in CNISP 2006-2007 Preliminary Results** [http://www.phac-aspc.gc.ca/nois-sinp/reports-rapport/mrsa-sarm_result-eng.php]
109. Dubberke ER, Olsen M a.: **Burden of Clostridium difficile on the Healthcare System.** *Clinical Infectious Diseases* 2012, **55**(suppl 2):S88–S92.
110. Bauer MP, Notermans DW, van Benthem BHB, Brazier JS, Wilcox MH, Rupnik M, Monnet DL, van Dissel JT, Kuijper EJ: **Clostridium difficile infection in Europe: a hospital-based survey.** *Lancet* 2011, **377**:63–73.
111. de Kraker ME a, Davey PG, Grundmann H: **Mortality and hospital stay associated with resistant Staphylococcus aureus and Escherichia coli bacteremia: estimating the burden of antibiotic resistance in Europe.** *PLoS medicine* 2011, **8**:e1001104.
112. World Health Organization: *Report on the Burden of Endemic Health Care-Associated Infection Worldwide - Clean Care Is Safer Care.* Geneva; 2011.
113. Allegranzi B, Bagheri Nejad S, Combescure C, Graafmans W, Attar H, Donaldson L, Pittet D: **Burden of endemic health-care-associated infection in developing countries: systematic review and meta-analysis.** *Lancet* 2011, **377**:228–41.
114. Deleo FR, Otto M, Kreiswirth BN, Chambers HF: **Community-associated methicillin-resistant Staphylococcus aureus.** *Lancet* 2010, **375**:1557–68.
115. Ricciardi R, Nelson J, Griffith JL, Concannon TW: **Do admissions and discharges to long-term care facilities influence hospital burden of Clostridium difficile infection?** *The Journal of hospital infection* 2012, **80**:156–61.

116. Opatowski L, Guillemot D, Boëlle P-Y, Temime L: **Contribution of mathematical modeling to the fight against bacterial antibiotic resistance.** *Current opinion in infectious diseases* 2011, **24**:279–87.
117. Temime L, Hejblum G, Setbon M, Valleron A.: **The rising impact of mathematical modelling in epidemiology : antibiotic resistance research as a case study.** *Epidemiol infect* 2008, **136**:289–298.
118. Hornbeck T, Naylor D, Segre AM, Thomas G, Herman T, Polgreen PM: **Using sensor networks to study the effect of peripatetic healthcare workers on the spread of hospital-associated infections.** *The Journal of infectious diseases* 2012, **206**:1549–57.
119. Ypma RJF, Bataille a M a, Stegeman a, Koch G, Wallinga J, van Ballegooijen WM: **Unravelling transmission trees of infectious diseases by combining genetic and epidemiological data.** *Proceedings Biological sciences / The Royal Society* 2012, **279**:444–50.
120. Morelli MJ, Thébaud G, Chadœuf J, King DP, Haydon DT, Soubeyrand S: **A Bayesian Inference Framework to Reconstruct Transmission Trees Using Epidemiological and Genetic Data.** *PLoS Computational Biology* 2012, **8**:e1002768.
121. Otto S., Day T: *A Biologist's Guide to Mathematical Modelling in Ecology and Evolution.* 1st edition. Oxfordshire: Princeton University Press; 2007:76.
122. Vanni T, Karnon J, Madan J, White RG, Edmunds WJ, Foss AM, Legood R: **Calibrating Models in Economic Evaluation.** *PharmacoEconomics* 2011, **29**:35–49.
123. Beggs CB, Noakes CJ, Shepherd SJ, Kerr KG, Sleigh PA, Banfield K: **The influence of nurse cohorting on hand hygiene effectiveness.** *American Journal of Infection Control* 2006, **34**:621–626.
124. Hotchkiss JR, Holley P, Crooke PS: **Analyzing pathogen transmission in the dialysis unit: time for a (schedule) change?** *Clinical Journal of The American Society of Nephrology: CJASN* 2007, **2**:1176–1185.
125. Nuno M, Reichert TA, Chowell G, Gumel AB: **Protecting residential care facilities from pandemic influenza.** *Proceedings of the National Academy of Sciences of the United States of America* 2008, **105**:10625–10630.

Supplementary material

Search terms MEDLINE

The search strategy was identical for EMBASE, Scopus, Global Health and CINHAL plus except for the MESH terms used, which were adjusted (or absent) for each database of concern.

- ti,ab = Search for specified search term in title, abstract
mp = Search for specified search term in title, abstract, subject heading, heading word, drug trade name, original title, device manufacturer, drug manufacturer, device trade name
and
keyword
/ = MESH/EMTREE term
\$ = Truncation
adj(N) = The maximum number of words allowed between the specified search terms

1. clostridium.ti,ab.
2. CDI.ti,ab.
3. CDAD.ti,ab.
4. VRSA.ti,ab.
5. VISA.ti,ab.
6. MSSA.ti,ab.
7. MRSA.ti,ab.
8. staphylococc\$.ti,ab.
9. Streptococc\$.ti,ab.
10. acinetobacter.ti,ab.
11. klebsiella.ti,ab.
12. Enterococc\$.ti,ab.
13. Escherichia.ti,ab.
14. E Coli.ti,ab.
15. Enterobacter\$.ti,ab.
16. citrobacter.ti,ab.
17. serratia.ti,ab.
18. Burkholderia.ti,ab.
19. Pseudomonas.ti,ab.
20. proteus.ti,ab.
21. Chryseobacteri\$.ti,ab.
22. Flavobacteri\$.ti,ab.
23. Alcaligenes.ti,ab.
24. Achromobacter.ti,ab.
25. legionell\$.ti,ab.
26. Mycobacteri\$.ti,ab.
27. rotavirus.ti,ab.
28. norovirus.ti,ab.
29. Respiratory Syncytial Viruses.ti,ab.
30. Hepatitis.ti,ab.
31. ebola.ti,ab.
32. Varicella-zoster.ti,ab.

33. Cytomegalovirus.ti,ab.
34. Adenovirus.ti,ab.
35. Giardia lamblia.ti,ab.
36. Candida albicans.ti,ab.
37. Aspergillus.ti,ab.
38. Cryptococc\$.ti,ab.
39. Cryptosporidi\$.ti,ab.
40. herpes\$.ti,ab.
41. SARS.ti,ab.
42. Severe Acute Respiratory Syndrome.ti,ab.
43. Influenza.ti,ab.
44. Microbial-drug-resistan\$.ti,ab.
45. Antibiotic-resistan\$.ti,ab.
46. Antimicrobial-resistan\$.ti,ab.
47. Multidrug resistan\$.ti,ab.
48. **or/1-47**
49. hospital\$.ti,ab.
50. nosocomial.ti,ab.
51. healthcare.ti,ab.
52. health care.ti,ab.
53. exp hospital/
54. exp hospital units/
55. **or/49-54**
56. **48 and 55**
57. exp Clostridium/
58. Clostridium difficile/
59. exp Clostridium Infections/
60. exp Staphylococcus aureus/
61. exp Staphylococcal Infections/
62. exp Escherichia coli/
63. exp Escherichia coli Infections/
64. exp Streptococcus/
65. exp Streptococcal Infections/
66. exp Klebsiella/
67. exp Klebsiella Infections/
68. exp Acinetobacter/
69. exp Acinetobacter Infections/
70. exp Enterobacter/
71. exp Citrobacter/
72. exp Serratia/
73. exp Serratia Infections/
74. exp Enterococcus/
75. exp Burkholderia/
76. exp Pseudomonas/
77. exp Burkholderia Infections/
78. exp Pseudomonas Infections/
79. exp Proteus/
80. exp Proteus Infections/
81. exp Flavobacteriaceae/
82. exp Alcaligenes/
83. exp Achromobacter/

84. exp Legionella/
85. exp Mycobacterium/
86. exp Rotavirus/
87. Rotavirus Infections/
88. exp Norovirus/
89. exp Respiratory Syncytial Viruses/
90. Influenza, Human/
91. exp Hepatitis, Viral, Human/
92. exp Enterovirus B, Human/
93. exp Enterovirus/
94. Enterovirus Infections/
95. exp Herpesviridae/
96. Ebolavirus/
97. exp Adenoviridae/
98. exp Giardia/
99. SARS Virus/
100. Severe Acute Respiratory Syndrome/
101. Candida albicans/
102. exp Aspergillus/
103. exp Cryptococcus/
104. exp Sarcoptes scabiei/
105. exp Drug Resistance, Microbial/
106. **or/57-105**
107. **48 or 106**
108. **55 and 107**
109. exp Cross Infection/
110. Infectious Disease Transmission, Professional-to-Patient/
111. Infectious Disease Transmission, Patient-to-Professional/
112. Cross infection.mp.
113. (professional-to-patient adj2 transmission).mp.
114. (patient-to-professional adj2 transmission).mp.
115. (patient-to-patient adj2 transmission).mp.
116. (Healthcare-associated adj2 infect\$).mp.
117. (Healthcare-associated adj2 disease\$).mp.
118. (Hospital-acquired adj2 infect\$).mp.
119. (Hospital-acquired adj2 disease\$).mp.
120. (Hospital-onset adj2 infect\$).mp.
121. (Hospital-onset adj2 disease\$).mp.
122. (Nosocomial adj2 infect\$).mp.
123. (Nosocomial adj2 disease\$).mp.
124. (Hospital adj2 transmiss\$).mp.
125. (Hospital adj2 infect\$).mp.
126. HCAI.mp.
127. HAI.mp.
128. **or/109-127**
129. Mathematic\$.ti,ab.
130. Compartment\$.ti,ab.
131. Stochastic.ti,ab.
132. Deterministic.ti,ab.
133. transmiss\$.ti,ab.
134. Epidemio\$.ti,ab.

- 135. Individual-based.ti,ab.
- 136. Population-based.ti,ab.
- 137. dynamic.ti,ab.
- 138. or/129-137
- 139. Model\$.ti,ab.
- 140. Model?ing.ti,ab.
- 141. Framework\$.ti,ab.
- 142. or/139-141
- 143. 138 and 142
- 144. Models, Theoretical/
- 145. mathematical computing/
- 146. Basic Reproduction Number/
- 147. Basic reproduction number.mp.
- 148. Effective reproduction number.mp.
- 149. Computer Simulation/
- 150. Markov chains/
- 151. Monte Carlo Method/
- 152. Bayes Theorem/
- 153. exp Stochastic Processes/
- 154. **or/144-153**
- 155. ((Mathematic\$ or Compartment\$ or Stochastic or Deterministic or Transmission or Epidemic\$ or Individual-based or population-based or Markov or Bayesian or equation or theoretic\$ or cost-effective\$ or cost-benefit or cost-consequence\$ or \$economic\$ or discrete-event or micro or agent-based or decision or decision-analytic or decision-tree) adj5 (Model\$ or Model?ing or Framework\$ or simulation\$)).ti,ab.
- 156. **108 or 128**
- 157. **154 or 155**
- 158. **156 and 157**

CHAPTER 3

NOSOCOMIAL TRANSMISSION OF *C. DIFFICILE* IN ENGLISH HOSPITALS FROM PATIENTS WITH SYMPTOMATIC INFECTION

3.1 PREAMBLE TO RESEARCH PAPER 2

Research paper one presented in the previous chapter, showed that dynamic transmission models have been used extensively to evaluate a wide range of hospital infection prevention and control policies[1]. In the discussion of the paper, the value of increased routine availability of genetic sequence data to help understand the epidemiology of HCAI was touched upon. Indeed, in more recent years, molecular typing data have been increasingly used in epidemiological studies to investigate the phylogeny and spread of pathogens[2–6]. Around the time of submission, i.e. 2012, similar data was published in a series of research papers relating to *C. difficile*. These studies found a high level of genomic diversity between symptomatic CDI patients, and identified only among a minority of the symptomatic patients in hospitals a genetic and epidemiological link to other hospitalised patients in an endemic setting [7–9].

The overall aim of this thesis is to investigate, in a modelling framework, the effectiveness of vaccination in a hospital-setting representative for England. The level of cross-transmission and the sources of transmission of an infection are important for choosing a model structure. For example, if person-to-person transmission is low, the population-effect of any intervention (i.e. reducing the risk of infection for the (hospital) population by reducing the number of transmission sources) including vaccination will be minimal or non-existent, and therefore a static model would suffice[10].

While the aforementioned whole genome sequencing work [7–9] shed some light on the transmission dynamics of *C. difficile*, the work was restricted to a limited number of hospitals and there remained a need to examine whether such trends were evidenced at a national level. Therefore, using the

English mandatory CDI surveillance data, research paper two examines the transmission dynamics of CDI at a national level as well as by hospital type (general, specialist and teaching hospitals). A statistical model is developed to investigate the presence of clustering in symptomatic CDI patients in hospitals in England between 2008 and 2012, indicative of CDI transmission in the hospital setting. This was the first time the importance of CDI in-hospital transmission was quantified at a national level.

This statistical model demonstrates a novel use of routinely collected mandatory data, providing clinically relevant insights into CDI epidemiology. The approach can be easily implemented in settings outside England, as well as for alternative infectious agents, as has recently been done for *E. coli* bloodstream infections[11].

3.2 RESEARCH PAPER 2

Nosocomial transmission of *C. difficile* in English hospitals from patients with symptomatic infection

Esther van Kleef^{1,2*}, Antonio Gasparri¹, Rebecca Guy², Barry Cookson³, Russell Hope², Mark Jit^{1,2},
Julie V. Robotham², Sarah R. Deeny², W. John Edmunds¹

¹ *London School of Hygiene and Tropical Medicine, London, United Kingdom*

² *Public Health England, Colindale, London, United Kingdom*

³ *University College London, London, United Kingdom*

Publication status: Published in *PLoS ONE* 2013, DOI: 10.1371/journal.pone.0099860

RESEARCH PAPER COVER SHEET

PLEASE NOTE THAT A COVER SHEET MUST BE COMPLETED FOR EACH RESEARCH PAPER INCLUDED IN A THESIS.

SECTION A – Student Details

Student	Esther van Kleef
Principal Supervisor	W.J. Edmunds
Thesis Title	Modelling studies of the transmission-dynamics and hospital burden of Clostridium difficile

If the Research Paper has previously been published please complete Section B, if not please move to Section C

SECTION B – Paper already published

Where was the work published?	PLOS ONE		
When was the work published?	2014		
If the work was published prior to registration for your research degree, give a brief rationale for its inclusion	N/A		
Have you retained the copyright for the work?*	Yes (Open acces**)	Was the work subject to academic peer review?	Yes

**If yes, please attach evidence of retention. If no, or if the work is being included in its published format, please attach evidence of permission from the copyright holder (publisher or other author) to include this work.*

SECTION C – Prepared for publication, but not yet published

Where is the work intended to be published?	
Please list the paper's authors in the intended authorship order:	
Stage of publication	Choose an item.

SECTION D – Multi-authored work

For multi-authored work, give full details of your role in the research included in the paper and in the preparation of the paper. (Attach a further sheet if necessary)	The candidate defined the research question of this manuscript in collaboration with WJE. The candidate decided on the methods employed in close consultation with AG and MK. RH and RG advised on what data to use for the statistical analysis. RG created the data extract and explained the necessary data fields to the candidate. The candidate
--	---

	performed the analysis and discussed and interpreted the results with AG, BC, JVR, MJ, SRD and WJE. The candidate wrote the first draft of the manuscript, and incorporated each round of comments and suggestions from all co-authors. All authors have read and approved the final manuscript prior to journal submission and agreed on inclusion in the dissertation.
--	--

Student Signature:  _____ **Date:** 19 November 2015

Supervisor Signature:  _____ **Date:** 19 November 2015

****Copyright policy of PLOS**

PLOS applies the Creative Commons Attribution (CC BY) license to works we publish. This license was developed to facilitate open access – namely, free immediate access to, and unrestricted reuse of, original works of all types.

Under this license, authors agree to make articles legally available for reuse, without permission or fees, for virtually any purpose. Anyone may copy, distribute or reuse these articles, as long as the author and original source are properly cited.

No permission is required from the authors or the publishers to reuse or repurpose PLOS content provided the original article is cited. In most cases, appropriate attribution can be provided by simply citing the original article.

<http://journals.plos.org/plosone/s/content-license>

Abstract

Background: Recent evidence suggests that less than one-quarter of patients with symptomatic nosocomial *Clostridium difficile* infections (CDI) are linked to other in-patients. However, this evidence was limited to one geographic area. We aimed to investigate the level of symptomatic CDI transmission in hospitals located across England from 2008 to 2012.

Methods: A generalized additive mixed-effects Poisson model was fitted to English hospital-surveillance data. After adjusting for seasonal fluctuations and between-hospital variation in reported CDI over time, possible clustering (transmission between symptomatic in-patients) of CDI cases was identified. We hypothesised that a temporal proximity would be reflected in the degree of correlation between in-hospital CDI cases per week. This correlation was modelled through a latent autoregressive structure of order 1 (AR(1)).

Findings: Forty-six hospitals (33 general, seven specialist, and six teaching hospitals) located in all English regions met our criteria. In total, 12,717 CDI cases were identified; seventy-five per cent of these occurred >48 hours after admission. There were slight increases in reports during winter months. We found a low, but statistically significant, correlation between successive weekly CDI case incidences ($\phi=0.029$, 95%CI: 0.009-0.049). This correlation was five times stronger in a subgroup analysis restricted to teaching hospitals ($\phi=0.104$, 95%CI: 0.048-0.159).

Conclusions: The results suggest that symptomatic patient-to-patient transmission has been a source of CDI-acquisition in English hospitals in recent years, and that this might be a more important transmission route in teaching hospitals. Nonetheless, the weak correlation indicates that, in line with recent evidence, symptomatic cases might not be the primary source of nosocomial CDI in England.

Keywords: *Clostridium difficile*, mixed-effects model, hospital-acquired infections

Introduction

Clostridium difficile infection (CDI) is a source of considerable morbidity and mortality for hospitalised patients, and its prevention, control and treatment place a substantial burden on healthcare systems[12, 13]. Since 2007, in addition to improved antimicrobial stewardship and mandatory surveillance, enhanced infection control measures to prevent *C. difficile* transmission have been implemented in England. These measures have focused on isolating symptomatic patients and improving hospital-cleaning regimens, with the goal of meeting government-led CDI reduction targets. Reported cases of CDI have dropped from 55,498 in 2007/08 to 18,005 in 2011/12[14], at a time when the prevalence of the hyper-virulent *C. difficile* BI/NAP1/027 also decreased[15]. Apart from improved antimicrobial stewardship, guidelines for CDI prevention and control assume that symptomatic patients in hospitals account for most *C. difficile* transmission and consequent infection (CDI). However, in 2012 and 2013, research using whole genome sequencing of hospital and community isolates from Oxfordshire, United Kingdom, has challenged this assumption. Eyre *et al* found a high level of genomic diversity in samples from symptomatic CDI patients. Moreover, only a minority of hospital-onset cases of CDI were found to share an epidemiological link as well as genomic link with a symptomatic CDI case[7–9].

This recent evidence was limited to a small sample of hospitals that were all located in one English county. To explore whether these new developments in our understanding of the epidemiology of CDI are more generally applicable, we investigated the presence of clustering in symptomatic CDI patients, indicative of patient-to-patient *C. difficile* transmission, in a wide range of hospitals in England between 2008 and 2012.

Methods

Data

The dataset consisted of mandatory reported details of each identified CDI case >2 years of age collected from all 167 National Health Service (NHS) Trusts via a web-enabled surveillance system, held by Public Health England (PHE)[16]. Details included the dates of admission and faecal sampling, patient category (e.g. inpatient, outpatient etc.) and age. Data covering the period between April 2008 and March

2012 were extracted from this surveillance scheme. To ensure consistency in the reported observations, we restricted our analyses to NHS acute trusts that followed the Department of Health's CDI testing guidance according to a survey held in 2010[17]. In England, a two test screening algorithm has been advocated and hospital trusts are recommended to test patients with diarrhoea (Bristol Stool Chart types 5-7)[18] using either a GDH Enzyme Immunoassay (GDH EIA), a nucleic acid amplification test (NAAT) or the Polymerase Chain Reaction (PCR), followed by a toxin sensitive EIA (or a cell cytotoxin neutralisation assay). If both the first test and the second test are positive, the case is eligible for reporting to PHE[19]. This resulted in the selection of data from 46 hospitals, belonging to 28 individual NHS acute Trusts, and excluded any of the Oxfordshire hospitals (see Table 4). Only CDI positive in-patients were included for analysis (i.e. excluding regular attendees, outpatients and patients having visited only accident and emergency departments). In order to evaluate healthcare facility associated infections, patients with onset of symptoms <48 hours after admission were excluded[20]. We aggregated the reported data per hospital by week, using the date of faecal sampling as the time of onset of CDI related symptoms.

Table 4: Description of CDI data from 46 selected hospitals

	N	Median/ Mean for 4 year period	IQR Q ₁ -Q ₃	Median/ Mean p.w.	IQR Q ₁ -Q ₃	Cases per 10,000 bed-days available (mean/median)
Number of weeks	209	-	-	-	-	-
Beds available per hospital	-	422/423	243-515	-	-	-
<i>General (n=33)</i>	-	444/416	346-500	-	-	-
<i>Teaching (n=6)</i>	-	837/754	799-941	-	-	-
<i>Specialist (n=7)</i>	-	134/169	95-243	-	-	-
CDI cases reported	12,717	244/276	138-377	1/1.3	0-2	4.1/4.6
<i>General</i>	8,974 (70.6%)	253/272	194-352	1/1.3	0-2	4.1/4.5
<i>Teaching</i>	3,348 (26.3%)	551/ 558	331-690	2/2.7	1-4	5.6/6.4
<i>Specialist</i>	395 (3.1%)	37/56	30-77	0/0.27	0-0	1.8/3.1
CDI cases reported with onset >48h	9,574	184/208	104-270	1/1.0	0-1	3.1/3.5
<i>General</i>	6,779 (70.8%)	200/205	140-247	1/1.0	0-2	3.2/3.5
<i>Teaching</i>	2,504 (26.2%)	370/417	252-534	1/2.0	0-3	4.1/5.3
<i>Specialist</i>	291 (3.0%)	31/42	28-53	0/0.2	0-0	1.2/2.2

Summary statistics of CDI cases reported to the English mandatory surveillance system by a selection of 46 hospitals from the period of April 2008 to March 2012. IQR = Interquartile range; p.w. = per week

Statistical methods

A generalized additive mixed-effects Poisson model, allowing for overdispersion, with a log link[21, 22], was used for the weekly observations of CDI counts. Three effects were identified that required inclusion in the linear predictor of this model. Firstly, hospital was introduced as a categorical variable to allow for potentially strong clustering due to differences in size, case-mix, and region (*see* Table 4). Secondly, a fixed polynomial-by-hospital interaction term was included to accommodate varying rates of change (primarily decline) over the four-year period in observed CDI per hospital; Figure 11 shows the time series of symptomatic CDI per hospital. Thirdly, a cyclic effect was included using a periodic penalised cubic regression spline to accommodate seasonal patterns of CDI, as have been observed previously in settings outside England, and which have been attributed to increased levels of “at risk” antibiotic use (e.g. ciprofloxacin) during the winter months (January to March), and influenza (which can lead to secondary bacterial infections requiring antibiotic treatment)[23–25]. The intention was that these three terms would account for the longitudinal behaviour of weekly CDI counts. Finally, a random error term was added to the linear predictor with an autoregressive correlation structure of order 1 (AR(1)) that would accommodate local (in time) departures from this base model. The autoregressive component of this error would be an indicator of local statistical dependence, and its presence would serve as a proposed marker for transmission between symptomatic cases (either directly, or indirectly via the hands of healthcare workers or hospital surfaces contaminated by symptomatic cases). Full details of the model are provided in the supplementary material.

Figure 11: Observed weekly number of CDI per hospital over the four-year study period

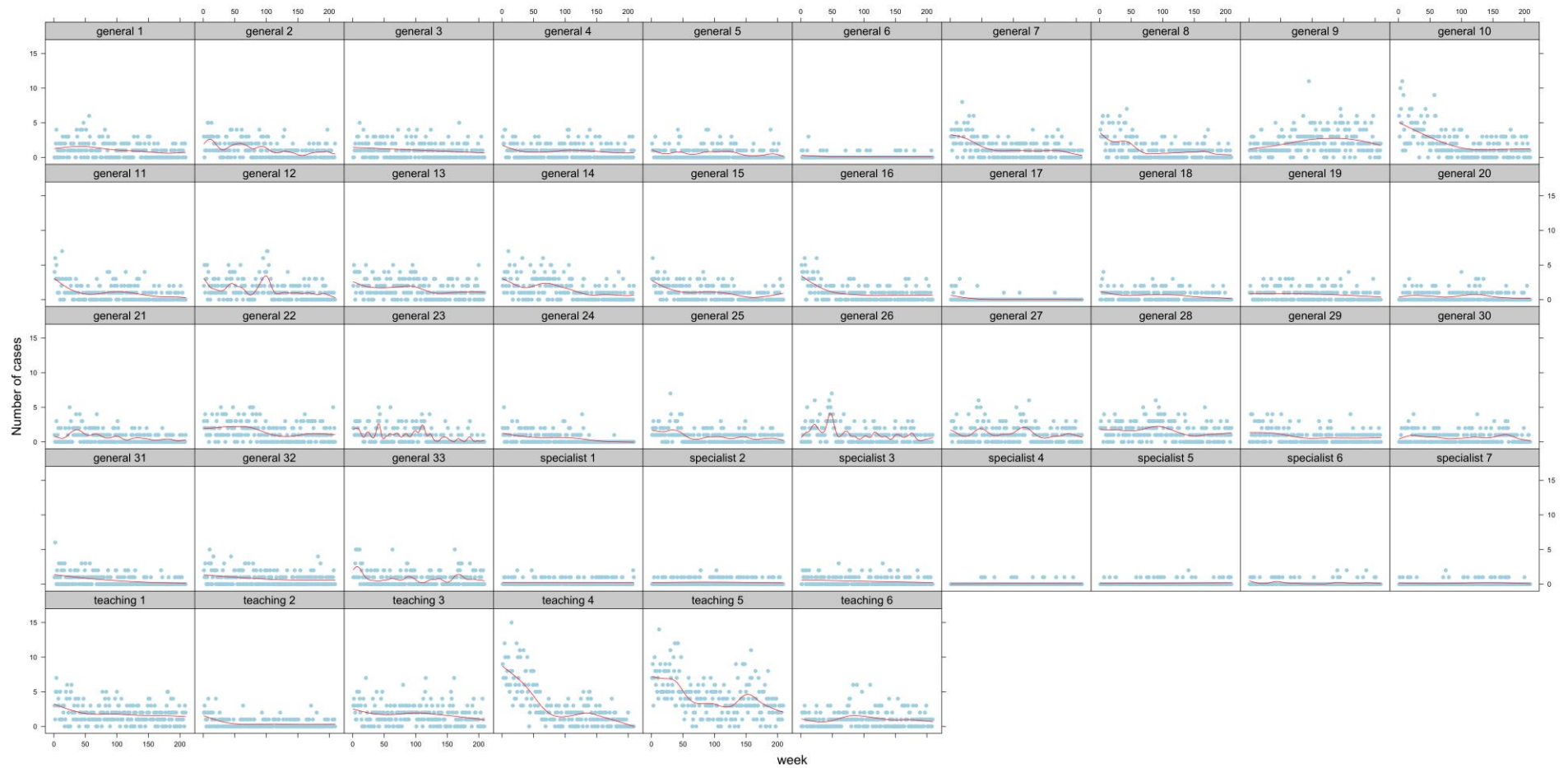

Grey dots represent the weekly-observed CDI cases within all hospitals from April 2008 to March 2012. X-axis: Week 0 corresponds to the first week of April 2008 and week 209 to the last week of March 2012. Red line: the incidence trend over time illustrated by cubic smoothing spline fit (for illustration).

All analyses were performed with R 3.0.1 (Team R Development Core, website: <http://cran.r-project.org/>) using the R package *mgcv*[26] and *splines*. To account more accurately for the decline in observed CDI since 2007, the comparative fit of three polynomials, linear, quadratic and cubic was assessed using Akaike Information Criterion (AIC). We added a cyclic (periodic) penalised cubic regression spline over the variable week of the year and compared model fit with and without this smoothing term representing seasonal variations, again based on AIC (see supplementary material). The standardized residuals were examined for significant departures from normality[27]. In addition, the Box-Pierce portmanteau statistic was used to indicate serial dependence.

Results

Descriptive statistics

The 46 hospitals reported 12,717 CDI cases in the four-year study period, of which 9,574 (75.3%) had an onset >48 hours after admission. Between 2008/09 and 2009/10 there was a 30.6% decline in CDI reported from these healthcare facilities, in comparison to 20.9% (2009/10 to 2010/11) and 15.7% (2010/11 to 2011/12) in the years thereafter. This is in line with national figures (29.1%, 18.0% and 17.1% respectively). Teaching hospitals reported the highest number of cases, which did not change once adjusted for their larger hospital size (expressed in the median number of cases per 10,000 bed-days available, where available bed-days is a crude estimate of the number of hospital beds in 2013[28] multiplied by the number of days covered by the study, see Table 4).

Base-model assuming no transmission patterns

For all three representations of the base-model, a model including seasonal patterns provided a moderately better fit, and a combination of seasonality and a cubic time trend proved the best model fit (see Supplementary table 1). By examining the correlogram of the final base-model's normalized residuals, we could identify whether there was evidence of serial dependence (Figure 12A). Such dependence could be explained by transmission between symptomatic CDI carriers. Figure 12A illustrates a low but significant correlation between cases in a given week and symptomatic carriers present in the hospital one

and two weeks earlier ($p < 0.05$), with a slightly stronger correlation at two weeks. Taking a total of a 20-week interval (as transmission events between hospital cases with an onset further than 20 weeks apart is assumed to be unlikely), the model revealed a highly significant Box-Pierce Q-statistic ($X^2 = 54.59$, degrees of freedom (df) = 20, $p = 0.00005$), indicating non-independence. Therefore, the AR(1)-model was fitted, with the best fitting cubic polynomial to represent the decline in CDI over time, as well as seasonality.

Figure 12: Dependence between observed weekly number of CDI – base-model

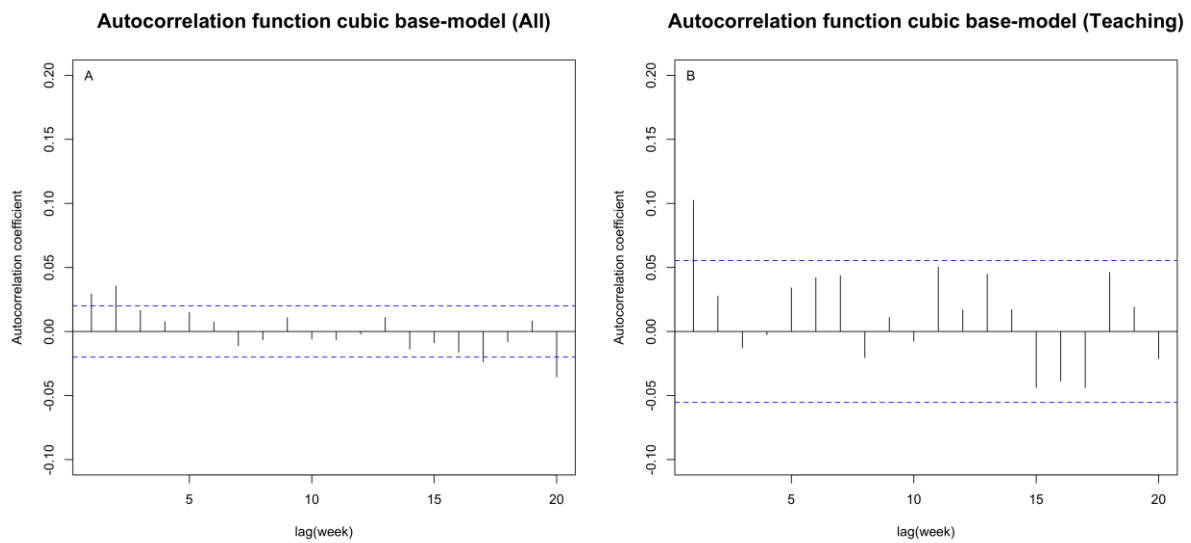

A and B: autocorrelation function (ACF) of normalized residuals of the base-model fitted to data of all hospitals (**A**) and of teaching hospitals only (**B**) including a fitted cubic representation of the CDI trend over time and seasonality. The blue lines correspond to the threshold for significance of correlation (dependence) ($p < 0.05$) between lagged weekly observations up to week 20. E.g. crossing of this threshold by the base-model residuals at lag 1 and lag 2 for the model fitted to all hospitals suggests that a correlation exists between the observed CDI in a given week and the number of CDI cases present in the hospital one and two weeks earlier.

AR(1)-model assuming transmission patterns

Supplementary figure 1 presents the seasonal variation of CDI in hospitals within our sample fitted by the AR(1)-model, and shows a slight increase during the months January to March. Assuming that symptomatic cases primarily caused acquisition among patients admitted to hospital up to one week later and, to a lesser extent, to cases admitted beyond this time (i.e. the AR(1) structure), the estimated

magnitude of dependence was low, but statistically significant ($\phi = 0.029$ (95% CI = 0.009-0.049)). This suggested that transmission between symptomatic CDI cases was affecting the weekly-observed CDI, but that its role in acquisition might be limited. This transmission pattern between observed weekly CDI was not fully explained by the AR(1) structure, as is indicated by the significant correlation at lag(week) 2 still being present after having fitted the AR(1) covariance structure (Box-Pierce Q-statistic ($X^2 = 44.4$, $df = 20$, p -value = 0.001)) (see Figure 13A).

AR(1)-model by hospital type

The negative correlation presented in the AR(1) cubic model after week 20 (Figure 13A) implied that the model might be over-fitting our data. Also, diagnostic plots suggested deviation from normality in the model's standardized residuals (see **Supplementary figure 2A**). This can be explained by the large variability in the number of reported cases per hospital, with a much greater number of reports and related rate of change in reports over time from teaching hospitals compared to just a few cases from specialist and some general hospitals. As a consequence, a hospital-specific term in the model representing the change in CDI reports over time might not be suitable for hospitals with only a few cases reported, whereas such specification is required to represent the CDI trend in teaching hospitals. Fitting the model to the more homogeneous group of teaching hospitals only, revealed a stronger, but still relatively low statistically significant correlation between CDI cases and patients present in the hospital one week later ($\phi = 0.104$ (95% CI = 0.048-0.159)) (see Figure 13A), which was captured by the AR(1)-structure (Box-Pierce Q-statistic $X^2 = 23.2$, $df = 20$, $p = 0.281$) (see Figure 13B).

Figure 14 illustrates the cubic AR(1) model predictions in comparison to the observed teaching hospital data and Supplementary figure 2, the model diagnostics.

Figure 13: Dependence between observed weekly number of CDI – AR(1)-model

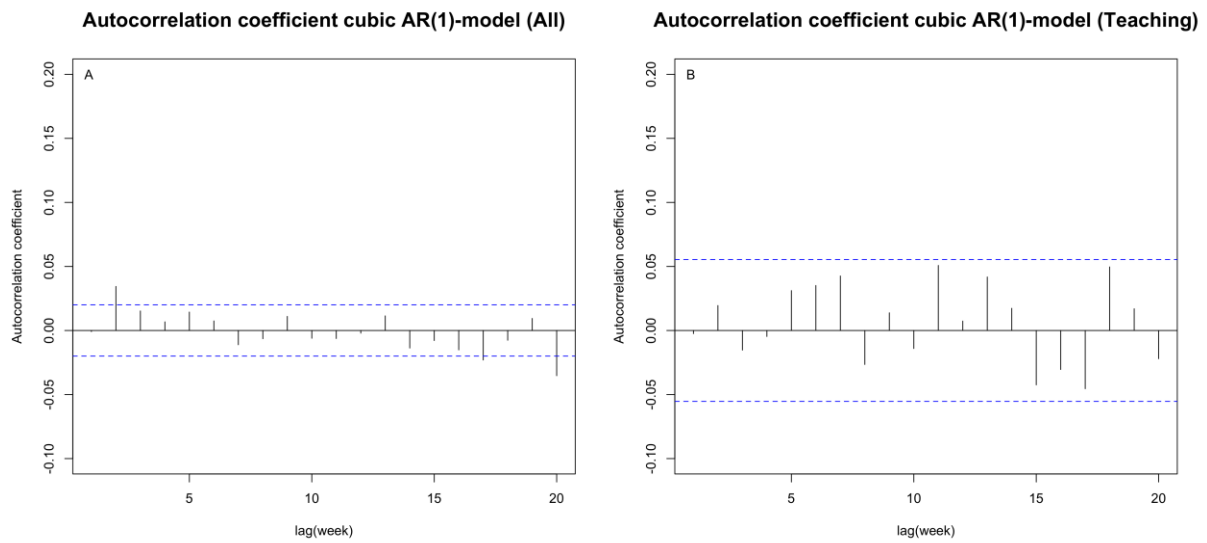

A and B: autocorrelation function (ACF) of normalized residuals of the AR(1)-model fitted to data of all hospitals **(A)** and of teaching hospitals only **(B)** including a fitted cubic representation of the CDI trend over time and seasonality. As in figure 2, the blue lines correspond to the threshold for significance of correlation (dependence) ($p < 0.05$) between lagged weekly observations up to week 20. Crossing of this threshold by the AR(1)-model residuals at lag 2 suggests the AR(1) structure (symptomatic cases primarily cause acquisition of *C. difficile* among patients admitted to hospital up to one week later and, to a lesser extent, to cases admitted beyond this time), does not fully explain the dependence structure between weekly observations.

Figure 14: AR(1) model fit teaching hospitals

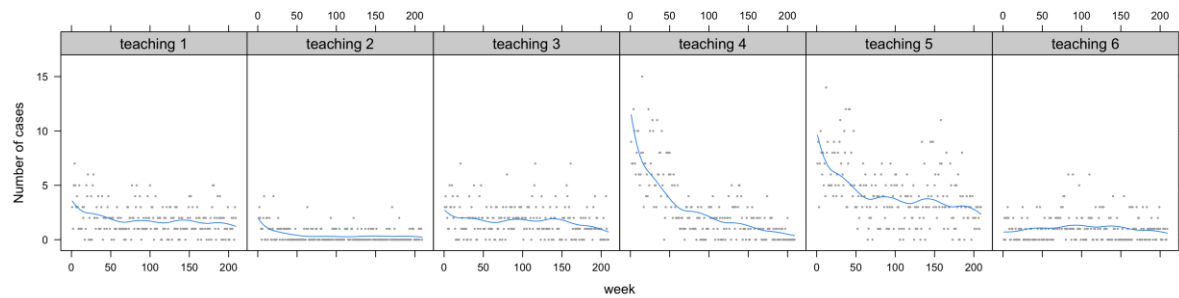

Grey dots represent the weekly-observed CDI cases within the teaching hospitals from April 2008 to March 2012. X-axis: Week 0 corresponds to the first week of April 2008 and week 209 to the last week of March 2012. Blue line: fit of the AR(1) model with a cubic representation of the rate of change of CDI over time and seasonality.

Discussion

In this study we explored the significance of symptomatic patient-to-patient CDI transmission in English hospitals as a source of hospital onset CDI. We found a statistically significant signal of dependence between symptomatic CDI patients spending time in hospital close in time, which suggested symptomatic patient-to-patient transmission of CDI was present. Nonetheless, the low magnitude of correlation between weekly cases in the AR(1) model, implies that the role of symptomatic carriers in CDI-acquisition was not as important as previously supposed. The highest number of CDI cases was reported in teaching hospitals, which corresponded to their overall prevalence of HCAI being among the highest according to the English National Point Prevalence Survey on Hospital-acquired infections (HCAI)[16]. This could be attributed to the more vulnerable case-mix of such hospitals, whom might be more prone to acquiring CDI[29]. Taking CDI reports from the teaching hospitals only, the association between symptomatic carriers was somewhat stronger, but still relatively low. Our findings are in line with recent evidence from whole genome sequencing of 1223 isolates from healthcare (among others from two large acute teaching hospitals, one specialist and one general district hospital) and community onset CDI cases in Oxfordshire, England isolated from 2008 to 2011[7]. Less than 20% of the genetically linked CDI positive cases had documented hospital contact with a symptomatic patient⁷. In addition, 45% of the included CDI cases could not be related to any other symptomatic case (community or healthcare setting) as they were too genetically diverse[7]. Even considering the reported low sensitivity of the toxin EIA test[20] used for CDI identification in the referenced study, the diversity argues for alternative sources of many CDI cases.

Improved infection control, with a primary focus on preventing transmission, such as hand hygiene, isolation of symptomatic cases, and environmental cleaning, might result in lower rates of successful transmission between symptomatic cases following contact[30]. In addition, once a patient comes in contact with *C. difficile* or its spores, the development of CDI is dependent on the disruption of the normal gut flora, primarily due to antibiotic use such as broad-spectrum cephalosporins and quinolones[31, 32]. Nonetheless, this would not explain the origin of symptomatic patients lacking a

shared spatial-temporal and/or genetic link. *C. difficile* has been recovered from hospital rooms occupied by both symptomatic and asymptomatic carriers[33–35] and its spores can persist in the environment for as long as 20 weeks[36]. Therefore, transmission from contaminated hospital surfaces could suggest symptomatic hospital cases are unrelated, whereas actually indirect-cross infection could have occurred. However, a genetic link would still be found if cases had acquired their infection from the same contaminated hospital surface. If no restrictions were applied to the infectious period, incubation period or length of ward contamination, 27% of the sequenced samples in the earlier mentioned study shared both a genetic and an epidemiological hospital contact [7]. Alternatively, asymptomatic carriers could contaminate hospital surfaces with lower intensity than symptomatic carriers, hence cause acquisition at low frequency, which could potentially explain the wide genomic diversity among cases [37].

Importation of symptomatic and asymptomatic carriers from community-settings such as long-term care facilities (LTCF) has also been suggested as a source for hospital-onset CDI[38, 39]. A population-based study conducted in the United States showed that out of a total of 416 identified CDI cases, 41% had onset of symptoms in the community or within 48 hours after admission and no hospitalisation in the 12 weeks prior to onset[40]. We excluded patients with an onset of CDI <48 hours into admission. This is a frequently used, but arbitrary, cut-off to define community-acquired HCAI. Hence it is possible that our data included asymptomatic patients who acquired the bacteria elsewhere, and developed symptoms in the hospital >48 hours after admission. Moreover, in addition to onset within 48 hours into admission, no hospitalisation in the past 12 weeks is an often-used additional requirement for community-acquired CDI [11]. As we did not have information on previous hospitalisation, the possibility exists that cases defined as community-acquired in our data, and were therefore excluded, actually were hospital-acquired cases, i.e. patients who acquired *C. difficile* in their previous stay, but started to develop symptoms after discharge and were re-admitted with symptomatic CDI. Furthermore, approximately 20% of cases with a first occurrence of CDI experience recurrence after discontinuation of treatment[41, 42]. Re-admitted CDI carriers, who resolved their symptoms but remained colonised resulting in a recurrent episode once e.g. put on at risk antibiotics, could be partly responsible for the low correlation between symptomatic

carriers. However, considering the known chances of relapse, we do not expect these can be primarily responsible for the results of this study.

Finally, and although not our primary focus, we found evidence of seasonal variations in CDI incidence in our selection of English hospitals, with slightly elevated reports of hospital-associated symptomatic CDI in the winter months. Seasonality has been suggested in relation to increased levels of CDI related antibiotics during the winter months in settings outside of England[23–25]. Comparison of variability in antibiotic prescribing patterns within English hospitals with fluctuations in hospital reported CDI incidence would be an interesting area of investigation. Nonetheless, the seasonal component in our model only explained a small proportion of the behaviour of the weekly reported CDI (reflected by a moderate decrease of AIC), and we would like to urge for more research on the presence of seasonal patterns of CDI in England.

This study had several limitations. Firstly, we selected weekly intervals for our analysis. Both the incubation time and infectious period of *C. difficile* have not been quantified with certainty. Studies have suggested that person-to-person transmission occurs primarily within a week (ranging from a median of 1, 4 or 8 days after CDI diagnosis)[8], whereas a median incubation time of 2-3 days[20] to 18-33 days has been proposed[8]. Hence, onset of symptoms following symptomatic patient-to-patient transmission might occur after the one-week time interval, which could have affected the strength of correlation between weekly incidences. Secondly, strains may vary in their pathogenicity[43] and transmissibility[9]. The routinely collected surveillance data did not contain ribotype specific information, so we could not establish to what extent our results are strain-specific as well as whether the hospitals in our sample are representative with regards to strain prevalence. Moreover, the AR(1) structure was unable to fully explain the correlation between weekly cases close in time using data from all hospital types, whereas it could for the teaching hospitals only. This might be a consequence of the stochastic nature of the few CDI cases reported by the smaller hospitals included in the overall dataset. Alternatively, teaching hospitals might have better environmental cleaning practices in place and/or are more likely to change antibiotic prescribing practices following an outbreak, resulting in more rapid containment. Further research is

needed to clarify the observed heterogeneity in reported hospital-acquired infection rates and transmission between teaching and non-teaching hospitals. Finally, alternative causes of dependence of the weekly CDI observations cannot be ruled out, e.g. a Scottish study[44] identified a temporal correlation between antibiotic use and HA-CDI [44]. However, as the results of the referenced study[44] suggest, it is unlikely that antibiotic hospital consumption will fluctuate between weekly time intervals. After investigation of the association between monthly variations in antibiotic use and monthly variations in observed CDI, Vernaz and colleagues (2009) identified that, for almost all of the antibiotics investigated, the association with observed CDI was significant with a lag of several months (among others ciprofloxacin, fluoroquinolones and cefuroxime) [44]. In addition, cases arising from asymptomatic carriers or environmental sources might correlate in space and time as well. However, the level of onward transmission from asymptotically colonised individuals is highly uncertain, nor has foodborne transmission of *C. difficile* to humans been established with certainty [45, 46]. Given the infectious nature of symptomatic *C. difficile* cases, especially in settings with high antibiotic use, we expect symptomatic patient-to-patient transmission to be the most conservative explanation.

Despite the limited information present in routinely collected hospital infection data, this study has provided further insight in the hospital transmission dynamics of *C. difficile*. Our results indicate that patient-to-patient transmission when only those patients with symptomatic CDI are considered, may account for a small number of transmission events. To improve our understanding of the epidemiology of CDI, the role of other patient groups should be considered, such as those in the community and asymptomatic carriers, as well as the importance of indirect transmission from contaminated surfaces in the hospital environment and the role of antibiotic use. Individual-level patient data, which can inform dynamic transmission models would certainly aid the investigating and quantification of the potential sources of CDI transmission[47–49] and will be another area of our further investigations.

Acknowledgments

We would like to thank Simon Goldenberg for sharing data on testing algorithm used in NHS hospital trusts. Also, we thank Mike Kenward, and Nathan Green for providing useful insights and helpful discussions on the statistical methods applied.

Conflict of interest statement

The authors declare that they have no competing interests.

Funding source

This work was supported by the Healthcare Infection Society.

References

1. Van Kleef E, Robotham J V, Jit M, Deeny SR, Edmunds WJ: **Modelling the transmission of healthcare associated infections: a systematic review.** *BMC Infect Dis* 2013, **13**:294.
2. Field N, Cohen T, Struelens MJ, Palm D, Cookson B, Glynn JR, Gallo V, Ramsay M, Sonnenberg P, Maccannell D, Charlett A, Egger M, Green J, Vineis P, Abubakar I: **Strengthening the Reporting of Molecular Epidemiology for Infectious Diseases (STROME-ID): an extension of the STROBE statement.** *Lancet Infect Dis* 2014, **14**:341–52.
3. Ypma RJF, Bataille a M a, Stegeman a, Koch G, Wallinga J, van Ballegooijen WM: **Unravelling transmission trees of infectious diseases by combining genetic and epidemiological data.** *Proc Biol Sci* 2012, **279**:444–50.
4. Worby CJ, Chang H, Hanage WP, Lipsitch M, Worby C, Ave H: **The distribution of pairwise genetic distances : a tool for investigating disease transmission.** *Genetics* 2014:1–23.
5. Tong SYC, Holden MTG, Nickerson EK, Cooper BS, Cori A, Jombart T, Cauchemez S, Fraser C, Wuthiekanun V, Thaipadungpanit J, Hongsuwan M, Day NP, Limmathurotsakul D, Parkhill J, Peacock SJ: **Genome sequencing defines phylogeny and spread of methicillin-resistant *Staphylococcus aureus* in a high transmission setting.** 2015:1–9.
6. Stoesser N, Sheppard a E, Shakya M, Sthapit B, Thorson S, Giess a, Kelly D, Pollard a J, Peto TE a, Walker a S, Crook DW: **Dynamics of MDR *Enterobacter cloacae* outbreaks in a neonatal unit in Nepal: insights using wider sampling frames and next-generation sequencing.** *J Antimicrob Chemother* 2015, **70**:1008–15.
7. Eyre DW, Cule ML, Wilson DJ, Griffiths D, Vaughan A, O'Connor L, Ip CLC, Golubchik T, Batty EM, Finney JM, Wyllie DH, Didelot X, Piazza P, Bowden R, Dingle KE, Harding RM, Crook DW, Wilcox MH, Peto TE a., Walker a. S: **Diverse Sources of *C. difficile* Infection Identified on Whole-Genome Sequencing.** *N Engl J Med* 2013, **369**:1195–1205.
8. Walker a S, Eyre DW, Wyllie DH, Dingle KE, Harding RM, O'Connor L, Griffiths D, Vaughan A, Finney J, Wilcox MH, Crook DW, Peto TE a: **Characterisation of *Clostridium difficile* Hospital Ward-Based Transmission Using Extensive Epidemiological Data and Molecular Typing.** *PLoS Med* 2012, **9**:e1001172.
9. Didelot X, Eyre D, Cule M, Ip C, Ansari A, Griffiths D, Vaughan A, O'Connor L, Golubchik T, Batty E, Piazza P, Wilson D, Bowden R, Donnelly P, Dingle K, Wilcox M, Walker S, Crook D, Peto T, Harding R: **Microevolutionary analysis of *Clostridium difficile* genomes to investigate transmission.** *Genome Biol* 2012, **13**:R118.
10. Edmunds WJ, Medley GF, Nokes DJ: **Evaluating the cost-effectiveness of vaccination programmes: a dynamic perspective.** *Stat Med* 1999, **18**:3263–82.
11. Deeny SR, van Kleef E, Bou-Antoun S, Hope RJ, Robotham J V: **Seasonal changes in the incidence of *Escherichia coli* bloodstream infection: variation with region and place of onset.** *Clin Microbiol Infect* 2015:1–6.
12. Ghantouji SS, Sail K, Lairson DR, DuPont HL, Garey KW: **Economic healthcare costs of *Clostridium difficile* infection: a systematic review.** *J Hosp Infect* 2010, **74**:309–318.

13. Dubberke ER, Olsen M a.: **Burden of Clostridium difficile on the Healthcare System.** *Clin Infect Dis* 2012, **55**(suppl 2):S88–S92.
14. **Mandatory surveillance of Clostridium difficile**
[http://www.hpa.org.uk/web/HPAweb&HPAwebStandard/HPAweb_C/1179746015058]
15. Wilcox MH, Shetty N, Fawley WN, Shemko M, Coen P, Birtles A, Cairns M, Curran MD, Dodgson KJ, Green SM, Hardy KJ, Hawkey PM, Magee JG, Sails a D, Wren MWD: **Changing Epidemiology of Clostridium difficile Infection Following the Introduction of a National Ribotyping-Based Surveillance Scheme in England.** *Clin Infect Dis* 2012, **55**.
16. Public Health England (former Health Protection Agency): *English National Point Prevalence Survey on Healthcare-Associated Infections and Antimicrobial Use, 2011 - Preliminary Data.* London; 2012.
17. Goldenberg SD, French GL: **Diagnostic testing for Clostridium difficile: a comprehensive survey of laboratories in England.** *J Hosp Infect* 2011, **79**:4–7.
18. Lewis S, Heaton K: **Stools form scale as a usefule guide to intestinal transit time.** *Scand J Gastroenterol* 1997, **32**:920–924.
19. Department of Health: *Updated Guidance on the Diagnosis and Reporting of Clostridium Difficile.* 2012.
20. Cohen SH, Gerding DN, Johnson S, Kelly CP, Loo VG, McDonald LC, Pepin J, Wilcox MH: **Clinical practice guidelines for Clostridium difficile infection in adults: 2010 update by the society for healthcare epidemiology of America (SHEA) and the infectious diseases society of America (IDSA).** *Infect Control Hosp Epidemiol* 2010, **31**:431–55.
21. Goldstein H: *Multilevel Statistical Models.* 4th edition. Chichester: Wiley-Blackwell; 2010.
22. Snijder TAB, Bosker RJ: *Multilevel Analysis: An Introduction to Basic and Advanced Multilevel Modeling.* 2nd edition. London, England: SAGE publications; 2012.
23. Archibald LK, Banerjee SN, Jarvis WR: **Secular trends in hospital-acquired Clostridium difficile disease in the United States, 1987-2001.** *J Infect Dis* 2004, **189**:1585–9.
24. Polgreen P, Yang M, Bohnett L, Cavanaugh J: **A Time-Series Analysis of Clostridium difficile and Its Seasonal Association with Influenza.** *Infect Control Hosp Epidemiol* 2010, **31**:382–387.
25. Gilca R, Fortin E, Frenette C, Longtin Y, Gourdeau M: **Seasonal variations in Clostridium difficile infections are associated with influenza and respiratory syncytial virus activity independently of antibiotic prescriptions: a time series analysis in Quebec, Canada.** *Antimicrob Agents Chemother* 2012, **56**:639–46.
26. Wood SN: *Generalized Additive Models: An Introduction with R.* 1st edition. London: Chapman and Hall/CRC; 2006.
27. Pinheiro JC, Bates DM: *Mixed-Effects Models in S and S-PLUS.* New York: Springer; 2000.
28. **Hospital guide** [<http://www.drfoosterhealth.co.uk/hospital-guide/>]
29. Söderlund N, Milne R, Gray a, Raftery J: **Differences in hospital casemix, and the relationship between casemix and hospital costs.** *J Public Health Med* 1995, **17**:25–32.

30. Hsu J, Abad C, Dinh M, Safdar N: **Prevention of endemic healthcare-associated Clostridium difficile infection: reviewing the evidence.** *Am J Gastroenterol* 2010, **105**:2327–39; quiz 2340.
31. Starr JM, Martin H, McCoubrey J, Gibson G, Poxton IR: **Risk factors for Clostridium difficile colonisation and toxin production.** *Age Ageing* 2003, **32**:657–60.
32. Thomas C, Stevenson M, Riley T V: **Antibiotics and hospital-acquired Clostridium difficile-associated diarrhoea: a systematic review.** *J Antimicrob Chemother* 2003, **51**:1339–1350.
33. McFarland LV, Mulligan ME, Kwok RYY, Stam WE: **Nosocomial acquisition of Clostridium difficile infection.** *N Engl J Med* 1989, **321**:190.
34. Samore MH, Venkataraman L, Degirolami PC, Arbeit RD, Karchmer AW: **Clinical and Molecular Epidemiology of Sporadic and Clustered Cases of Nosocomial Clostridium difficile Diarrhea.** *Am J Med* 1996, **100**(January):32–40.
35. Kaatz G, Gitlin S, Schaberg D, Wilson KH, Kauffman CA, Seo SM, Fekety R: **Acquisition of clostridium difficile from the hospital environment.** *Am J Epidemiol* 1988, **127**:1289–1294.
36. Kim K, Fekety R, Batts DH, Brown D: **Isolation of Clostridium difficile from the Environment and Contacts of Patients with Antibiotic-Associated Colitis.** *J Infect Dis* 1981, **143**:42–50.
37. Guerrero DM, Becker JC, Eckstein EC, Kundrapu S, Deshpande a, Sethi a K, Donskey CJ: **Asymptomatic carriage of toxigenic Clostridium difficile by hospitalized patients.** *J Hosp Infect* 2013:2–5.
38. Ricciardi R, Nelson J, Griffith JL, Concannon TW: **Do admissions and discharges to long-term care facilities influence hospital burden of Clostridium difficile infection?** *J Hosp Infect* 2012, **80**:156–61.
39. Riggs MM, Sethi AK, Zabarsky TF, Eckstein EC, Jump RLP, Donskey CJ: **Asymptomatic Carriers Are a Potential Source for Transmission of Epidemic and Nonepidemic Clostridium difficile Strains among Long-Term Care Facility Residents.** *Clin Infect Dis* 2007, **45**:992–998.
40. Khanna S, Pardi DS, Aronson SL, Kammer PP, Orenstein R, Sauver JLS, Harmsen WS, Zinsmeister AR: **The Epidemiology of Community-Acquired Clostridium difficile Infection : A Population-Based Study.** *Am J Gastroenterol* 2011, **107**:89–95.
41. Kamboj M, Khosa P, Kaltsas A, Babady NE, Son C, Sepkowitz K a: **Relapse versus reinfection: surveillance of Clostridium difficile infection.** *Clin Infect Dis* 2011, **53**:1003–6.
42. Fekety R, McFarland L V, Surawicz CM, Greenberg RN, Elmer GW, Mulligan ME: **Recurrent Clostridium difficile diarrhea: characteristics of and risk factors for patients enrolled in a prospective, randomized, double-blinded trial.** *Clin Infect Dis* 1997, **24**:324–33.
43. Walker a S, Eyre DW, Wyllie DH, Dingle KE, Griffiths D, Shine B, Oakley S, O'Connor L, Finney J, Vaughan A, Crook DW, Wilcox MH, Peto TE a: **Relationship Between Bacterial Strain Type, Host Biomarkers, and Mortality in Clostridium difficile Infection.** *Clin Infect Dis* 2013, **56**:1589–600.
44. Vernaz N, Hill K, Leggeat S, Nathwani D, Philips G, Bonnabry P, Davey P: **Temporal effects of antibiotic use and Clostridium difficile infections.** *J Antimicrob Chemother* 2009, **63**:1272–5.

45. Eyre DW, Griffiths D, Vaughan A, Golubchik T, Acharya M, O'Connor L, Crook DW, Walker a S, Peto TE a: **Asymptomatic Clostridium difficile colonisation and onward transmission.** *PLoS One* 2013, **8**:e78445.
46. Gould LH, Limbago B: **Clostridium difficile in food and domestic animals: a new foodborne pathogen?** *Clin Infect Dis* 2010, **51**:577–82.
47. Bootsma MCJ, Bonten MJM, Nijssen S, Fluit a C, Diekmann O: **An algorithm to estimate the importance of bacterial acquisition routes in hospital settings.** *Am J Epidemiol* 2007, **166**:841–51.
48. McBryde ES, Pettitt AN, Cooper BS, McElwain DLS: **Characterizing an outbreak of vancomycin-resistant enterococci using hidden Markov models.** *J R Soc Interface* 2007, **4**:745–754.
49. Forrester ML, Pettitt AN, Gibson GJ: **Bayesian inference of hospital-acquired infectious diseases and control measures given imperfect surveillance data.** *Biostatistics* 2007, **8**:383–401.

Supplementary material

A1. Model description

The following generalized additive mixed effects Poisson model allowing for overdispersion, with a log link[1, 2] was used for fitting to the data of all hospitals as well as of the teaching hospitals alone:

$$Y_{jt}|R_{jt} \sim \text{Poisson}(\lambda_{jt})$$

$$\log(\lambda_{jt}) = \alpha_j + f_{1j}(t) + f_2(t_{w.o.y.}) + R_{jt}$$

Where, λ_{jt} indicates the observed number of CDI cases λ at week t in individual hospital j , given the random error term R_{jt} (see later), α_j and $f_1(t)$ are the individual hospital intercept and representation of the cross-sectional trend respectively, and $f_2(t_{w.o.y.})$ the seasonal variation in CDI incidence. The alternative representations of the longitudinal CDI trend were specified as a linear, quadratic and cubic polynomial respectively. We added a cyclic (periodic) penalised cubic regression spline over the variable week of the year, i.e. $f_2(t_{w.o.y.}) = \sum_{i=1}^{k-1} \tilde{b}_i(t_{w.o.y.})S_i$; we provided the end points of the smoother (i.e. the first and last week of the year, week 1 and week 53) and allowed automatic generation of the remainder knots (knots specify adjacent intervals, where each interval represents an individual polynomial)[3]. Finally, R_{jt} denotes the residual term in hospital j at week t , which were of primary interest. We assumed a temporal proximity pattern and allowed for additional Poisson variation $Z_t \sim \text{iid } N(0, \sigma^2)$. This temporal proximity assumed that incidences of weeks close in time are strongly correlated, and that this correlation faded rapidly over time according to $R_{jt} = \phi^k R_{j(t-k)} + Z_t$, $k = 1, 2, \dots$ [4], k represents the weekly distance between the incidence observations and ϕ corresponds to the strength of the correlation, i.e. the correlation coefficient. If $\phi^k = 0$, this corresponds to no (auto)correlation, and thus no weekly CDI dependence, indicating no symptomatic transmission. If $\phi^k = 0$ and $\sigma^2 = 0$, the data follows a simple Poisson distribution.

A2. Model Fitting

The base-model (assuming no transmission, i.e. excluding AR(1)) was fitted by a penalised likelihood using the command `gam()` (library `mgcv`). The different polynomials, denoting alternative representations of the CDI incidence trend, were fitted by generating a B-spline basis matrix without interior knots using the command `bs()` (library `splines`) and seasonality was represented by a cyclic cubic smooth function using the command `s(., bs = "cc")` (library `mgcv`)[3]. The models were fitted both with a Poisson and quasi-Poisson distribution, the latter to allow for overdispersion (represented by a scale parameter >1 (Supplementary table 1) which is common in hospital count data. For all three representations of the base-model, a model including seasonal patterns provided a moderately better fit (with a reduction in AIC of 15.3, 14.3, 16.3, for the linear, quadratic and cubic null-models including seasonality, respectively). For the seasonal trend, the distributional assumption under the null-hypothesis (chi-square) does not have a firm theoretical basis and is conditional on the smoothing parameter (i.e. the degrees of freedom estimated for the smooth term). Hence, the p-value provided by the `gam` model for the seasonal trend is an approximation and should be considered with care[3]. However, considering the reduction in AIC, seasonality was kept in the model. Supplementary table 1 summarizes model fit of the different representations of the declining incidence trend over time and adjusting for seasonality. A linear representation provided the worst model fit. Both the quadratic and the cubic time trend showed a considerable improvement in model fit in comparison to the linear trend, while the cubic time trend showed a moderately better fit in comparison to the quadratic time trend. As a next step, we added an AR(1) temporal covariance structure using the Penalised Quasi-likelihood based (PQL) based command `gamm()` (library `mgcv`). In contrast to `gam()`, this command allows the addition of patterned covariance structures. This method can work poorly (i.e. underestimate the standard error of the fitted parameters) for Poisson data with a mean number of counts of less than five[1, 5]. Comparison of model fit by a penalised likelihood and PQL resulted in similar model estimates for our base-model, which provided confidence in the PQL method used for our data. Another caveat of the PQL method is the lack of a real likelihood. Hence, it was not possible to formally test whether the inclusion of the AR(1) residual correlation structure indeed did improve model fit. For this reason, we evaluated the estimated value of

ϕ^k (i.e. whether departure from 0), and the autocorrelation function (ACF) coefficients of the best fitting null-model and AR(1) model normalized residuals to test departure from independence ($p < 0.05$).

Supplementary table 1: Comparison of model fit for the base-model including alternative representations of the CDI incidence trend

All hospitals		Poisson			Quasi-Poisson			
Model		AIC	X²	p-value seasonality	AIC	F	p-value seasonality	Scale parameter
<i>Linear seasonality</i>	+	22544	25.91	0.0002	NA	25.91	.0006	1.095
<i>Quadratic seasonality</i>	+	22454	24.99	0.0003	NA	2.837	.0008	1.081
<i>Cubic seasonality</i>	+	22426	27.31	0.0001	NA	3.131	.0003	1.074
<i>Cubic no seasonality</i>		22442	-	-	NA	-	-	1.076
Teaching hospitals		Poisson			Quasi-Poisson			
Model		AIC	X²	p-value seasonality	AIC	F	p-value seasonality	Scale parameter
<i>Linear seasonality</i>	+	4054	6.54	0.142	NA	.003	.374	1.304
<i>Quadratic seasonality</i>	+	4032	6.33	0.108	NA	.156	.222	1.282
<i>Cubic seasonality</i>	+	4018	18.18	0.005	NA	.854	.016	1.266
<i>Cubic no seasonality</i>		4025	-	-	NA	-	-	1.273

AIC = Akaike Information Criterion, the lower the value, the better the fit. Upper half of table: model fit to data of all hospitals. Lower half: model fit to data from teaching hospitals. Left half of table: model fit assuming a Poisson distribution. Right half: model fit assuming an overdispersed Poisson (quasi-Poisson) distribution)

Supplementary figure 1: Seasonal variations of symptomatic *C. difficile* infection with onset >48 hours after admission

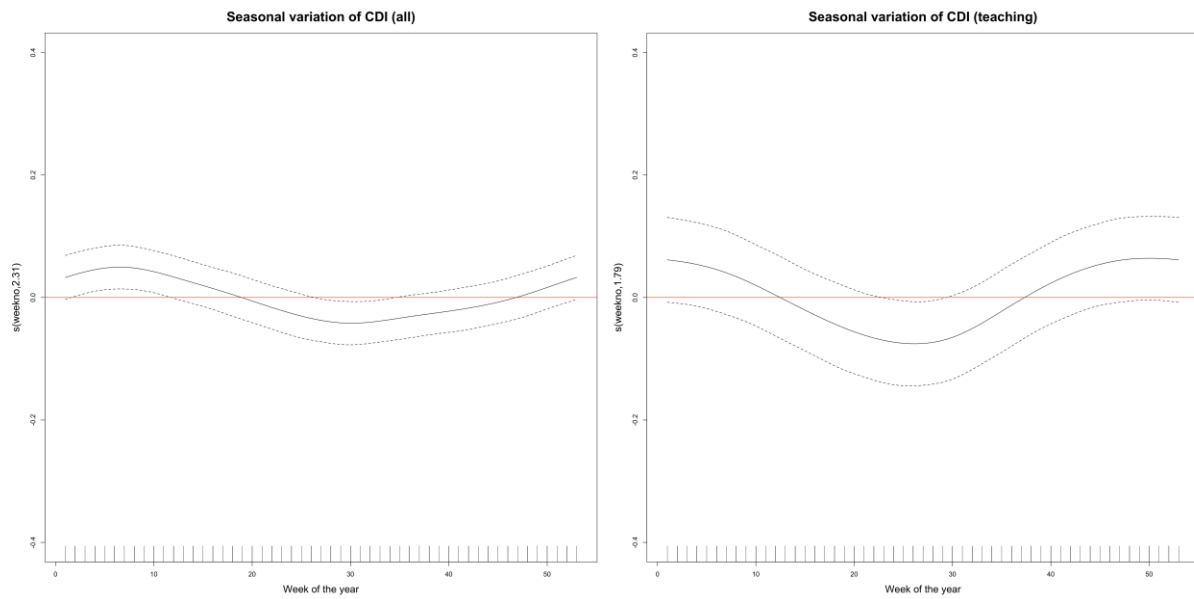

Fitted cyclic penalised cubic regression spline (representing season variations) for the cubic AR(1) model fitted to data of all hospitals (A) and data of the teaching hospitals only (B).

Supplementary figure 2: Diagnostics of cubic AR(1)-models

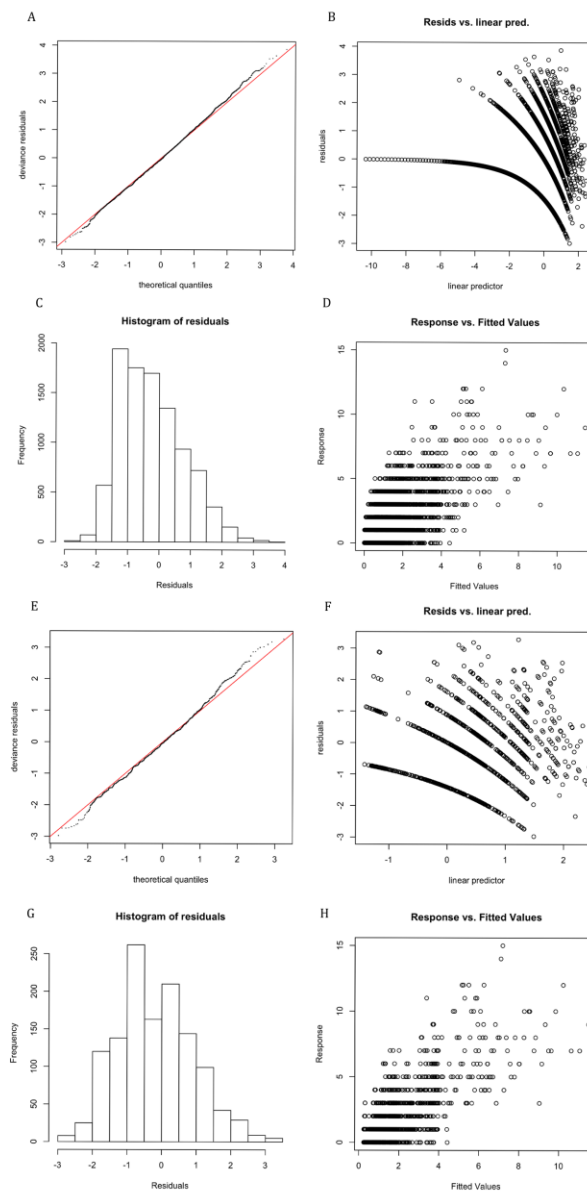

Residual diagnostics of AR(1)-model fitted to data of all hospitals, including a fitted cubic representation of CDI behaviour over time and seasonality. A: Quantile-Quantile (Q-Q) plot, deviation from a straight line denotes deviation from normal distribution. B: Residuals plotted against the linear predictor. C: frequency distribution of the model residuals. D: data against fitted values. E-H: Residual diagnostics of AR(1)-model fitted to data of teaching hospital only.

A4. References

1. Snijder TAB, Bosker RJ: *Multilevel Analysis: An Introduction to Basic and Advanced Multilevel Modeling*. 2nd edition. London, England: SAGE publications; 2012.
2. Goldstein H: *Multilevel Statistical Models*. 4th edition. Chichester: Wiley-Blackwell; 2010.
3. Wood SN: *Generalized Additive Models: An Introduction with R*. 1st edition. London: Chapman and Hall/CRC; 2006.
4. Pinheiro JC, Bates DM: *Mixed-Effects Models in S and S-PLUS*. New York: Springer; 2000.
5. Bolker BM, Brooks ME, Clark CJ, Geange SW, Poulsen JR, Stevens MHH, White J-SS: **Generalized linear mixed models: a practical guide for ecology and evolution**. *Trends Ecol Evol* 2009, **24**:127–35.

CHAPTER 4

EXCESS LENGTH OF STAY AND MORTALITY DUE TO *CLOSTRIDIUM DIFFICILE* INFECTION: A MULTI-STATE MODELLING APPROACH

4.1 PREAMBLE TO RESEARCH PAPER 3

As laid out in Chapter one, estimates of LoS and mortality are key determinants to help quantify the health and economic burden of hospital-acquired infections, including CDI[1]. Previous estimates of additional excess bed days attributable to healthcare-acquired (HA)-CDI have varied widely, partly due to methodological weaknesses[2]. Patients that stay in hospital longer are at increased risk of acquiring a nosocomial infection. Therefore, a ‘naïve’ approach of retrospectively comparing the mean LoS of CDI-negative patients to the mean LoS of CDI-positive patients would result in biased estimates, i.e. inflate the effect of hospital stay attributable to CDI[3]. Retrospectively matching cases to controls based on the time to exposure, that is, matching exposed patients (e.g. CDI cases) to unexposed patients that were in hospital at least as long as the time (t) of CDI-onset in the exposed person, accounts for this so-called time dependent bias to some extent[4]. However, as this approach conditions on events that occur after the time of exposure, i.e. matches exposed patients to unexposed patients that are still in hospital at time t and remain negative until discharge, selection bias is introduced[5].

Both of these methods have predominated in CDI literature[2, 6]. At the time of publication of research paper three, the only two previous studies that did employ appropriate methods, that is Cox proportional hazard modelling including CDI as a time-dependent exposure and/or multi-state modelling (both are further explained in research paper three), reported very different results, i.e. no CDI attributable stay[7] compared to an additional stay of six days[8]. Hence there remains considerable uncertainty in the literature on the impact of CDI on length of stay. Moreover, no robust estimates of the excess LoS due to CDI are available from an English, nor European-setting.

From the perspective of modelling the effectiveness of CDI vaccination, the excess time that CDI patients spend in hospital and/or the in-hospital risk of mortality are important. Both give insight into the incremental cost of the infection, and additionally are likely to have an impact on the transmission-dynamics of the infection. Research paper three is the first to investigate excess LoS and mortality due to CDI in a large English hospital using robust and currently preferred methods. Moreover, the paper investigates the impact of the severity of CDI on these outcomes. As research paper three reports on the severity of CDI of patients in our sample, the infection causing ribotypes, as well as patient co-morbidities, the work allows for interpretation of the generalisability of the findings to other hospitals or regions.

Excess length of stay and mortality due to *Clostridium difficile* infection: a multi-state modelling approach

Esther van Kleef^{1,2*}, Nathan Green^{2,3}, Simon D. Goldenberg⁴, Julie V. Robotham², Barry Cookson⁵,

Mark Jit^{1,2}, W. John Edmunds¹, Sarah R. Deeny²

¹ *London School of Hygiene and Tropical Medicine*, London, United Kingdom

² *Public Health England*, Colindale, London, United Kingdom

³ *Imperial College London*, London, United Kingdom

⁴ *Guy's & St Thomas' NHS Foundation Trust and King's College*, London, United Kingdom

⁵ *University College London*, London, United Kingdom

Publication status: Published in *Journal of Hospital Infection*, 2014,

DOI: <http://dx.doi.org/10.1016/j.jhin.2014.08.008>

Registry

T: +44(0)20 7299 4646
F: +44(0)20 7299 4656
E: registry@lshtm.ac.uk

RESEARCH PAPER COVER SHEET

PLEASE NOTE THAT A COVER SHEET MUST BE COMPLETED FOR EACH RESEARCH PAPER INCLUDED IN A THESIS.

SECTION A – Student Details

Student	Esther van Kleef
Principal Supervisor	W.J. Edmunds
Thesis Title	Modelling studies of the transmission-dynamics and hospital burden of Clostridium difficile

If the Research Paper has previously been published please complete Section B, if not please move to Section C

SECTION B – Paper already published

Where was the work published?	Journal of Hospital Infection		
When was the work published?	2014		
If the work was published prior to registration for your research degree, give a brief rationale for its inclusion	N/A		
Have you retained the copyright for the work?*	No **	Was the work subject to academic peer review?	Yes

**If yes, please attach evidence of retention. If no, or if the work is being included in its published format, please attach evidence of permission from the copyright holder (publisher or other author) to include this work.*

SECTION C – Prepared for publication, but not yet published

Where is the work intended to be published?	
Please list the paper's authors in the intended authorship order:	
Stage of publication	Choose an item.

SECTION D – Multi-authored work

For multi-authored work, give full details of your role in the research included in the paper and in the preparation of the paper. (Attach a further sheet if necessary)	The candidate defined the research question in close collaboration with SRD. The candidate conducted the statistical analysis in consultation with NG, and SRD and NG participated in the interpretation of the results. The data was provided and data fields explained by SDG. Moreover, SDG advised the candidate on the definition used for
--	---

	severe CDI cases. The candidate wrote the manuscript with significant contributions from all co-authors. All authors have read and approved the final manuscript prior to journal submission and agreed on inclusion in the dissertation
--	--

Student Signature: _____



Date: 19 November 2015

Supervisor Signature: _____



Date: 19 November 2015

****Copyright policy Journal of Hospital Infection**

Authors transfer copyright to the publisher as part of a journal publishing agreement, but have the right to:

- Share their article for Personal Use, Internal Institutional Use and Scholarly Sharing purposes, with a DOI link to the version of record on ScienceDirect (and with the Creative CommonsCC-BY-NC- ND license for author manuscript versions)
- Retain patent, trademark and other intellectual property rights (including raw research data).
- Proper attribution and credit for the published work.

<https://www.elsevier.com/about/company-information/policies/copyright>

Abstract

Background: The burden of healthcare associated infections (HCAI), including healthcare-acquired *Clostridium difficile* (HA-CDI) can be expressed in terms of additional length of stay (LoS) and mortality. However, previous estimates have varied widely and, although some considered time of infection onset (time-dependent bias), none considered the impact of severity of HA-CDI; this was the primary aim of this study.

Methods: The daily risk of in-hospital death or discharge was modelled using a Cox proportional hazards model, fitted to data on patients discharged in 2012 from a large English teaching hospital. We treated HA-CDI status as a time-dependent variable and adjusted for confounders. In addition, a multi-state model was developed to provide a clinically intuitive metric of delayed discharge associated with non-severe and severe HA-CDI respectively.

Findings: Data comprised 157 (including 48 severe) HA-CDI cases amongst 42,618 patients. HA-CDI reduced the daily discharge rate by nearly one-quarter (HR: 0.72 (95% CI: 0.61-0.84) and increased the in-hospital death-rate by 75% compared with non-HA-CDI patients (HR: 1.75 (95% CI: 1.16-2.62). Whereas, overall HA-CDI resulted in a mean excess LoS of ~7 days (95%CI = 3.5 – 10.9), severe cases had an average excess LoS which was twice (~11.6 days [95% CI = 3.6-19.6] that of the non-severe cases (~5 days [1.1-9.5]).

Conclusions: HA-CDI contributes to patients' expected LoS and risk of mortality. However, when quantifying the health and economic burden of hospital-onset of HA-CDI, the heterogeneity in the impact of HA-CDI should be accounted for.

Introduction

Clostridium difficile, is a considerable cause of healthcare acquired infections (HCAI) in Europe and the United States[9, 10]. In common with other HCAI, patients with healthcare-acquired *Clostridium difficile* infection (HA-CDI) place a serious health and economic burden on the hospital system. Previous economic analyses of HA-CDI have shown that direct healthcare, and opportunity, costs due to excess length of hospital stay (LoS) were the main HA-CDI cost drivers[11–14]. However, a recent review of publications on HA-CDI associated additional hospital stay, showed wide variation in excess LoS, ranging from 2.8 to 16.1 days[2]. These studies primarily used simple regression models, which did not account for the timing of onset of infection (“time-dependent bias”)[15]. Hence, they may overestimate the duration of excess hospitalisation, as a longer stay in hospital may increase the risk of infection. This has been demonstrated rigorously for other HCAI[1, 15, 16] but has rarely been explicitly explored for HA-CDI[2].

Two recent publications, which implicitly adjust for “time dependent bias”, reported very different results[7,8]. Forster *et al*, using a Cox proportional hazards model, concluded that HA-CDI patients had a median excess LoS of six days,[8], while Mitchell *et al* found no significant impact of HA-CDI on hospital stay[7]. Mitchell *et al* utilised multi-state model (MSM), that in addition to appropriately adjusting for both time to event bias and the competing end-points related to nosocomial infections, namely discharge and death[7], also provided more easily interpretable results than the proportional hazards model. In their conclusion, Mitchell *et al* posit that their results, and the difference to earlier estimates, could potentially be explained by milder HA-CDI due to a lack of circulating hypervirulent PCR ribotype 027 in their locality (Tasmania, Australia).

As the clinical presentation of HA-CDI can range from mild diarrhoea to pseudomembranous colitis and even death, and the prevalence of severe HA-CDI can vary regionally, due to differences in ribotype prevalence[17–19] and case-mix[20], it is important for any estimation of attributable LoS and mortality to consider these heterogeneities. In this study, we demonstrate the impact of severe infection on the expected delayed discharge and mortality associated with HA-CDI based on a Cox proportional hazard model as well as MSM techniques. Hence, we provide, for the first time, a robust estimate of

excess LoS due to HA-CDI in an English teaching hospital and quantify the additional impact of severe HA-CDI on LoS and mortality.

Methods

Data

Data were collected from Guy's and St Thomas' National Health Service (NHS) Foundation Trust, a teaching hospital including two sites with ~1200 beds. Details of all inpatients discharged in 2012 (namely: age, primary diagnosis code, dates of admission and discharge, and discharge status [i.e. discharge alive or death]) were extracted from the Trust's electronic patient record database. These data were linked to the Trust's voluntarily collected HA-CDI surveillance database containing information on date of onset of symptoms, markers of HA-CDI severity, antibiotic treatment and, where known the ribotype that caused the infection. In order to evaluate only those infections that were hospital-acquired, patients with symptom-onset ≤ 48 hours after admission and all patients with a LoS ≤ 48 hours were excluded from analyses.

Severe HA-CDI

Severe HA-CDI was defined by the clinical presence of one or more of four indicators: i) peripheral white blood cell count $>15 \times 10^9/L$; ii) acutely rising serum creatinine ($>50\%$ increase above baseline); iii) temperature $>38.5^\circ C$; or iv) radiographic evidence of colitis or endoscopic appearance of pseudomembranous colitis[21].

Procedure

Proportions and medians were compared using the X^2 test and Mann-Whitney-Wilcoxon test respectively. We used a Cox proportional hazards model to estimate the impact of HA-CDI on the risk of hospital discharge alive or death. This method can adjust for time-dependent bias and take into account the impact of important non-HCAI variables such as age and co-morbidity score on LoS. Hence, the method can identify and adjust for important confounders. Nonetheless, it does not produce an easily interpretable metric (namely hazard ratios) for economic analysis. Therefore we constructed a suitable MSM, to quantify the average excess LoS caused by the event of interest, i.e. HA-CDI. However, using

established methodology, MSM do not account for the potential confounding effect of other variables. As an alternative, we stratified our data by each of the relevant confounders, and performed the MSM on these subsamples.

Statistical analysis

Cox Regression Model

The risk of in-hospital death or discharge was modelled with a Cox proportional hazards model, with HA-CDI treated as a time-dependent risk factor. We added the covariates age and co-morbidity to assess their confounding effects on the risk of in-hospital death or discharge. Co-morbidity was expressed in a Charlson co-morbidity index score[22] based on the patients' primary diagnosis code. These primary diagnoses were classified using International Statistical Classification of Diseases and Related Health Problems 10th Revision (ICD-10) codes[22].

Multi-state Model

We developed a MSM with four states; admission with no HA-CDI (state 0), HA-CDI (state 1), discharge alive (state 2) and death in hospital (state 3)[23]. Since we were solely concerned with HA-CDI, we assumed all patients were admitted to the hospital without infection. Uninfected patients remained in state 0 from admission until discharge (state 2) or in-hospital death (state 3). Infected patients entered state 1 and then remained in that state until discharge or death. This competing end-points approach allowed for assessment of the impact of mortality due to HA-CDI on a patients' expected excess stay, e.g. whether HA-CDI-related mortality may in fact shorten expected LoS. Secondly, prolonged LoS associated with HA-CDI was estimated by constructing a MSM where the two competing end-points were combined as a single state[24]. Transitions between states were determined by time-varying hazards, which were estimated using the Aalen-Johansen estimator[25]. For each point in time t (in days), the expected LoS for HA-CDI and non-infected patients was compared. The unadjusted expected change in LoS was then calculated as the average difference in LoS of HA-CDI and non-HA-CDI cases across all days, weighted relative to the frequency of the possible events (i.e. HA-CDI, discharge alive and in-hospital death) on each day[5]. Bootstrapping[26] was used to obtain robust standard error-based confidence intervals.

To assess the effect of specific confounders identified by the Cox regression model, we performed the MSM comparing patients within their risk group by stratification, for each potential confounding variable separately. Also, to evaluate the effect of severe HA-CDI on excess LoS, a stratified analysis was conducted, comparing mean differences in LoS of non-severe HA-CDI and severe HA-CDI cases respectively to non-infected patients.

All analyses were performed with R 3.0.1 (Team R Development Core, website: <http://cran.r-project.org/>). The R-packages *mvna* and *etm* were used to estimate the excess LoS and standard errors[25, 27] and the R-package *survival* was used for the Cox model.

Results

Descriptive statistics

The data comprised a total sample of 42,618 patients, 157 (0.4%) of whom had an episode of HA-CDI, of which 48 (30.6%) were severe (Table 5). The median age was 72 years [Inter-quartile range (IQR) = 57-82] for the infected, which was significantly higher than the median age of non-infected patients (47 [IQR = 26-68], $p < 0.0001$). The vast majority of all patients had no reported co-morbidities (91.6%, 39,146 patients). This percentage was slightly lower in the HA-CDI infected patient group (84.7%, 133 patients), than in the non-infected group (91.9%, 39,013 patients, $p = 0.002$). On average, patients with severe HA-CDI had spent a shorter time in hospital until identification of the infection than non-severe cases (Table 5). Moreover, after detection, the median LoS was longer for severely infected patients (Table 5). Finally, the causative PCR ribotypes were known for 113 (72.0%) of the HA-CDI patients. None of these patients had an infection caused by hypervirulent PCR ribotype 027 (Supplementary table 2).

Table 5: Demographic characteristics of the Guy's & St Thomas hospital patients discharged in 2012

Variable	Non-infected N = 42,461	Infected N=157	Non-severe HA-CDI N = 109	Severe HA-CDI N=48	Total N=42,618
Age (N (%))					
<i>>65 years old</i>	13,446 (31.7)	102 (65.0)	73 (67.0)	29 (60.4)	13,548 (31.8)
Co-morbidity (N (%))					
<i>Charlson index score = 0</i>	39,013 (91.9)	133 (84.7)	96 (88.1)	37 (77.1)	39,146 (91.9)
<i>Charlson index score ≥ 1</i>	3,448 (8.1)	24 (15.3)	13 (11.9)	11 (22.9)	3472 (8.1)
Death (N (%))					
<i>Yes</i>	801 (1.9)	24 (15.3)	15 (13.8)	9 (18.7)	825 (1.9)
Length of stay (Median/Mean [IQR])	4.0/7.6 [2.0-8.0]	25.0/36.6 [15.0-50.0]	29.0/36.6 [15.0-50.0]	22.5/36.8 [14.8-44.8]	4.0/7.7 [2.0-8.0]
Length of stay pre- infection (Median/Mean [IQR])	NA	9.0/15.8 [4.0-18.0]	10.0/17.1 [4.0-22.0]	7.0/12.1 [3.8-12.3]	NA
Length of stay post- infection (Median/Mean [IQR])	NA	12.0/21.1 [6.0-25.0]	11.0/19.5 [6.0-24.0]	13.5/24.6 [7.8-27.8]	NA

Cox regression model results

HA-CDI-positive patients had a lower daily chance of being discharged (alive or dead) than non-infected patients (Table 6). Both age of the patient (i.e. older or younger than 65 years old), and the patient's co-morbidity were significant confounders, and the adjusted daily hazard of discharge (AHR) for HA-CDI patients was 0.72 [95% Confidence Interval (CI): 0.61-0.84] (Table 6). Moreover, HA-CDI patients were at higher risk of experiencing in-hospital death than HA-CDI-negative patients (AHR = 1.75 [95% CI: 1.16-2.62]). Accounting for severity of the infection revealed that, compared to non-infected patients, severe cases had a daily likelihood of discharge which was two times more reduced than the probability of discharge of non-severe cases (Table 6). However, severe infection did not result in a further elevated chance of dying in hospital (Table 6).

Multi-State Model results

The four state multi-state model, which allowed for competing end-points, and the three state combined end-point model provided similar estimates for the excess LoS. Thus mortality due to HA-CDI did not seem to have an impact on the estimated additional days of hospitalisation associated with HA-CDI. For this reason, the outcomes of the combined end-point model are presented only. The average extra number of days (unadjusted for confounders) spent in hospital due to HA-CDI was ~7 days [95% CI = 4 – 11] (Table 6). Patients with severe HA-CDI had, on average, twice the additional LoS of non-severe cases, but with overlapping confidence intervals (Table 6). Stratification of our sample by age and co-morbidity score still showed an impact of HA-CDI on the patients' stay. Among HA-CDI patients <65 years of age (55 patients in total), we found an average excess LoS of ~7 days [95% CI = 1-14 days [associated with HA-CDI; for the >65 population (133 patients) this was ~6 days [95% CI = 2-11]. A sample restricted to patients with a co-morbidity score <1 only (133 patients) showed an excess LoS of ~7 days [95% CI = 3-11] whereas an average excess LoS of ~10 days [95% CI = -1-21] associated with HA-CDI was found for patients with a score of >1 (24 patients).

Table 6: Hazard ratios for in-hospital death or discharge alive and excess length of stay estimated from the Cox Regression Model and Multi-State Model

Exposure	Hazard ratio for discharge alive (95% CI) ^a		Hazard ratio for in-hospital death (95% CI) ^a		Hazard ratio for discharge alive or death (95% CI) ^a		Excess LOS (95% CI) ^d
	Time adjusted ^b	Fully adjusted ^c	Time adjusted ^b	Fully adjusted ^c	Time adjusted ^b	Fully adjusted ^c	
All CDI	0.66 (0.56-0.77)	0.72 (0.61-0.84)	1.98 (1.33-2.96)	1.75 (1.16-2.62)	0.73 (0.64-0.84)	0.79 (0.69-0.92)	7.2 (3.5-10.9)
Severe CDI^e	0.53 (0.39-0.71)	0.59 (0.44-0.79)	2.11 (1.17-3.79)	1.76 (0.95-3.25)	0.62 (0.49-0.76)	0.69 (0.54-0.85)	11.6 (3.6-19.6)
Non-Severe CDI	0.73 (0.60-0.88)	0.79 (0.66-0.96)	1.91 (1.13-3.22)	1.74 (1.03-2.93)	0.80 (0.67-0.95)	0.86 (0.71-1.03)	5.3 (1.1-9.5)

CI, confidence interval; LOS, length of hospital stay; CDI, *Clostridium difficile* infection. To estimate the hazard ratios for discharge alive and in-hospital death respectively, the observations on patients who experienced a competing risk event were censored, i.e. removed from the risk set used for the hazard calculation at time of occurrence of the event, based on the principles of the cause-specific hazard function.

a. Cox regression model.

b. Cox regression model with time to infection included as a time-dependent variable.

c. Cox regression model with time to infection included as a time-dependent variable, and age (<65 and >65 years) and comorbidity (Charlson Comorbidity Index score <1 and ≥1) included as covariates.

d. Multi-state model

e. The estimates for non-severe and severe CDI were fitted by including CDI type as a three level time-dependent categorical variable (0. No infection; 1. Non-severe CDI and 2. Severe CDI)

Discussion

The findings of this study showed that HA-CDI resulted in a prolonged LoS of ~ 7 days. Moreover, the daily mortality rate of HA-CDI patients was almost twice that of non-HA-CDI infected patients, as has been suggested elsewhere[28]. In addition, we found that severe infection increased the average expected excess LoS associated with HA-CDI. Our LoS estimates are comparable to the median additional six days estimated by a Canadian study, which also adjusted for the time dependency of the impact of HA-CDI[8], but contradict the findings of a recent study by Mitchell and co-workers (2013) using a comparable MSM conducted in an Australian hospital who suggested that HA-CDI did not result in excess LoS⁷. As the MSM of Mitchell et al did not implicitly adjust for such potential confounders, difference in case-mix among the different hospital settings (UK and Australia) could have been responsible for the differences in measured excess LoS[29]. However, stratified MSM results (by age, and co-morbidity index score respectively) revealed that both younger and older HA-CDI patients had an increased average LoS of about 6-7 days, and patients of both co-morbidity groups had an increased expected LoS related to CDI, so this is not likely to be the reason. Moreover, the non-severe HA-CDI patients in our sample still had a significantly increased LoS of ~ 5 days, thus even the potential lack of severely infected patients in the Australian sample would have most likely resulted in an effect on LoS. However, with only three published studies using appropriate methods, little can be concluded with regards the heterogeneity in the findings. More appropriate analyses of existing datasets (e.g. those reviewed by Mitchell et al (2012)[2]) might be a sensible way forward.

Our dataset was collected as part of routine record keeping in a large teaching hospital, which led to a number of limitations in our study. Firstly, the number of patients with HA-CDI was small, which resulted in relatively large standard errors for the risk group stratified MSM analysis. A larger dataset would have allowed sufficient power to sub-stratify the analysis further. Secondly, the co-morbidity index was calculated using only the primary diagnosis code of each patient, as more detailed information was not available to the researchers. Therefore, our analysis might not have fully adjusted for the effect of concomitant conditions. Finally, patients that spend a longer time in hospital are at increased risk of acquiring an HCAI other than HA-CDI, which could have extended their LoS rather than HA-CDI. However, considering the construction of the MSM, we expect this is accounted for: HA-CDI positive

patients which were in hospital at a given number of days post-onset were compared to admitted HA-CDI negative patients still in hospital after this number of days. Thus, both these populations were arguably equally at risk of acquiring a HCAI other than HA-CDI.

In conclusion, we present work confirming the heterogeneity among patients of the health and economic burden of CDI. To our knowledge, the results of our research have provided the first severity specific estimate of the additional LoS and excess mortality due to CDI. We believe that the techniques presented here could be applied, locally, nationally and regionally to provide policy makers with an estimate of the burden of CDI for their patient population and severity of CDI.

Funding

This work was supported by the Healthcare Infection Society.

References

1. Graves N, Harbarth S, Beyersmann J, Barnett A, Halton K, Cooper B: **Estimating the cost of health care-associated infections: Mind your p's and q's.** *Clin Infect Dis* 2010, **50**:1017–1021.
2. Mitchell BG, Gardner A: **Prolongation of length of stay and Clostridium difficile infection: a review of the methods used to examine length of stay due to healthcare associated infections.** *Antimicrob Resist Infect Control* 2012, **1**:14.
3. Beyersmann J, Gastmeier P, Wolkewitz M, Schumacher M: **An easy mathematical proof showed that time-dependent bias inevitably leads to biased effect estimation.** *J Clin Epidemiol* 2008, **61**:1216–1221.
4. Wolkewitz M, Beyersmann J, Gastmeier P, Schumacher M: **Efficient risk set sampling when a time-dependent exposure is present: matching for time to exposure versus exposure density sampling.** *Methods Inf Med* 2009, **48**:438–43.
5. Schulgen G, Schumacher M: **Estimation of prolongation of hospital stay attributable to nosocomial infections: New approaches based on multistate models.** *Lifetime Data Anal* 1996, **2**:219–240.
6. Gabriel L, Beriot-Mathiot a: **Hospitalization stay and costs attributable to Clostridium difficile infection: a critical review.** *J Hosp Infect* 2014, **88**:12–21.
7. Mitchell BG, Gardner A, Barnett AG, Hiller JE, Graves N: **The prolongation of length of stay because of Clostridium difficile infection.** *Am J Infect Control* 2013:1–4.
8. Forster AJ, Taljaard M, Oake N, Wilson KW, Roth V, van Walraven C: **The effect of hospital-acquired infection with Clostridium difficile on length of stay in hospital.** *CMAJ* 2012, **184**:17–8.
9. Bauer MP, Notermans DW, van Benthem BHB, Brazier JS, Wilcox MH, Rupnik M, Monnet DL, van Dissel JT, Kuijper EJ: **Clostridium difficile infection in Europe: a hospital-based survey.** *Lancet* 2011, **377**:63–73.
10. Kuijper EJ, Coignard B, Tüll P: **Emergence of Clostridium difficile-associated disease in North America and Europe.** *Clin Microbiol Infect* 2006, **12 Suppl 6**(October):2–18.
11. Dubberke ER, Olsen MA: **Burden of Clostridium difficile on the healthcare system.** *Clin Infect Dis* 2012, **55 Suppl 2**(Suppl 2):S88–92.
12. Dubberke ER, Reske K a, Olsen M a, McDonald LC, Fraser VJ: **Short- and long-term attributable costs of Clostridium difficile-associated disease in nonsurgical inpatients.** *Clin Infect Dis* 2008, **46**:497–504.
13. McGlone SM, Bailey RR, Zimmer SM, Popovich MJ, Tian Y, Ufberg P, Muder RR, Lee BY: **The economic burden of Clostridium difficile.** *Clin Microbiol Infect* 2012, **18**:282–9.
14. Ghantaji SS, Sail K, Lairson DR, DuPont HL, Garey KW: **Economic healthcare costs of Clostridium difficile infection: a systematic review.** *J Hosp Infect* 2010, **74**:309–318.
15. Van Walraven C, Davis D, Forster AJ, Wells G a: **Time-dependent bias was common in survival analyses published in leading clinical journals.** *J Clin Epidemiol* 2004, **57**:672–82.

16. Barnett AG, Beyersmann J, Allignol A, Rosenthal VD, Graves N, Wolkewitz M: **The time-dependent bias and its effect on extra length of stay due to nosocomial infection.** *Value Heal* 2011, **14**:381–386.
17. Wilcox MH, Shetty N, Fawley WN, Shemko M, Coen P, Birtles A, Cairns M, Curran MD, Dodgson KJ, Green SM, Hardy KJ, Hawkey PM, Magee JG, Sails a D, Wren MWD: **Changing Epidemiology of Clostridium difficile Infection Following the Introduction of a National Ribotyping-Based Surveillance Scheme in England.** *Clin Infect Dis* 2012, **55**.
18. Walker a S, Eyre DW, Wyllie DH, Dingle KE, Griffiths D, Shine B, Oakley S, O'Connor L, Finney J, Vaughan A, Crook DW, Wilcox MH, Peto TE a: **Relationship Between Bacterial Strain Type, Host Biomarkers, and Mortality in Clostridium difficile Infection.** *Clin Infect Dis* 2013, **56**:1589–600.
19. Goorhuis A, Bakker D, Corver J, Debast SB, Harmanus C, Notermans DW, Bergwerff A a, Dekker FW, Kuijper EJ: **Emergence of Clostridium difficile infection due to a new hypervirulent strain, polymerase chain reaction ribotype 078.** *Clin Infect Dis* 2008, **47**:1162–70.
20. Henrich TJ, Krakower D, Bitton A, Yokoe DS: **Clinical risk factors for severe Clostridium difficile-associated disease.** *Emerg Infect Dis* 2009, **15**:415–22.
21. Debast SB, Bauer MP, Kuijper EJ: **European Society of Clinical Microbiology and Infectious Diseases: update of the treatment guidance document for Clostridium difficile infection.** *Clin Microbiol Infect* 2014, **20 Suppl 2**(March):1–26.
22. Sundararajan V, Henderson T, Perry C, Muggivan A, Quan H, Ghali W a: **New ICD-10 version of the Charlson comorbidity index predicted in-hospital mortality.** *J Clin Epidemiol* 2004, **57**:1288–94.
23. Beyersmann J, Wolkewitz M, Allignol A, Grambauer N, Schumacher M: **Application of multistate models in hospital epidemiology: advances and challenges.** *Biometrical J* 2011, **53**:332–350.
24. Angelis G de, Allignol A, Murthy A, Wolkewitz M, Beyersmann J, Safran E, Schrenzel J, Pittet D, Harbarth S: **Multistate modelling to estimate the excess length of stay associated with meticillin-resistant Staphylococcus aureus colonisation and infection in surgical patients.** *J Hosp Infect* 2011, **78**:86–91.
25. Allignol A, Schumacher M, Beyersmann J: **Empirical Transition Matrix of Multi-State Models : The etm Package.** *J Stat Softw* 2011, **38**:1–15.
26. Davison AC, Hinkley DV: *Bootstrap Methods and Their Application.* New York: Cambridge University Press; 1997.
27. Jackson CH: **Multistate models for panel data.** *J Stat Softw* 2011, **38**.
28. Hensgens MPM, Goorhuis A, Dekkers OM, van Benthem BHB, Kuijper EJ: **All-Cause and Disease-Specific Mortality in Hospitalized Patients With Clostridium difficile Infection: A Multicenter Cohort Study.** *Clin Infect Dis* 2013, **56**:1108–16.
29. Louie TJ, Miller M a, Crook DW, Lentnek A, Bernard L, High KP, Shue Y-K, Gorbach SL: **Effect of age on treatment outcomes in Clostridium difficile infection.** *J Am Geriatr Soc* 2013, **61**:222–30.

Supplementary material

Supplementary table 2: Average length of stay post-infection and number of deaths stratified by ribotype

PCR ribotype	Patients N (%)	Deaths N (%)	Severe infection N (%)	Mean LoS post-infection	IQR (Q1-Q3)
<i>001</i>	6 (3.8)	0 (0.0)	2 (0.3)	9.8	4.8 - 36.0
<i>002</i>	21 (13.4)	6 (28.6)	9 (42.9)	22.0	8.0 - 27.0
<i>005</i>	14 (8.9)	2 (14.3)	3 (0.2)	19.6	3.5 - 30.8
<i>014/020</i>	23 (14.6)	2 (8.7)	6 (0.1)	30.0	11.5 - 36.0
<i>015</i>	17 (10.8)	2 (11.8)	6 (35.3)	24.4	10.0 - 30.0
<i>017</i>	2 (1.3)	0 (0.0)	0 (0.0)	9.0	6.5 - 11.5
<i>018</i>	4 (2.5)	0 (0.0)	1 (0.3)	8.8	4.8 - 10.5
<i>023</i>	4 (2.5)	1 (0.3)	0 (0.0)	30.5	5.8 - 49.3
<i>038</i>	3 (1.9)	1 (0.3)	0 (0.0)	47.0	10.0 - 65.5
<i>064</i>	2 (1.3)	0 (0.0)	0 (0.0)	2.5	2.3 - 2.8
<i>078</i>	10 (6.4)	3 (30.0)	4 (0.3)	9.2	1.5 - 16.0
<i>106</i>	7 (4.5)	1 (14.3)	0 (0.0)	16.1	9.0 - 22.0
<i>Unknown/UT</i>	44 (28.0)	6 (13.6)	15 (34.1)	20.0	6.8 - 23.3

UT = PCR ribotyping not possible

Supplementary figure 3: Length of Stay HA-CDI cases stratified by HA-CDI PCR ribotype

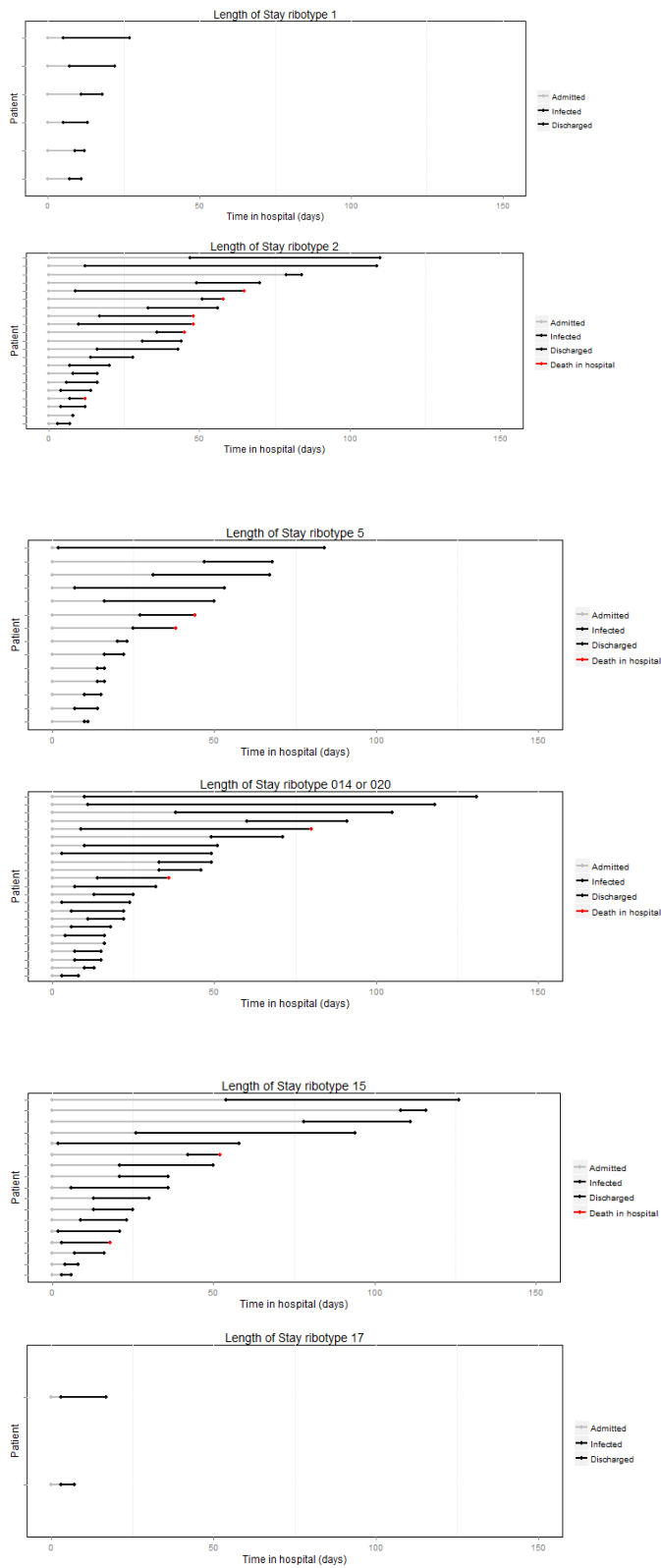

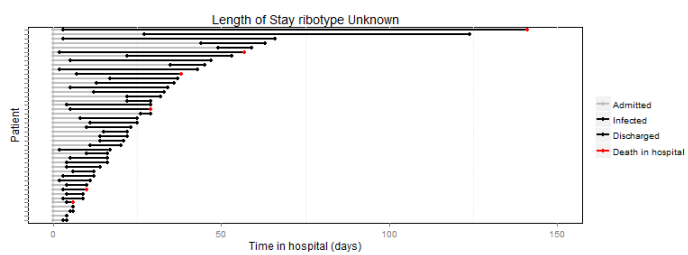
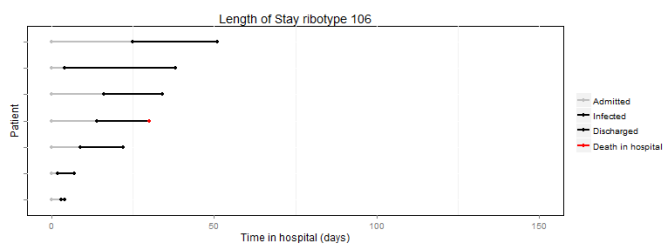
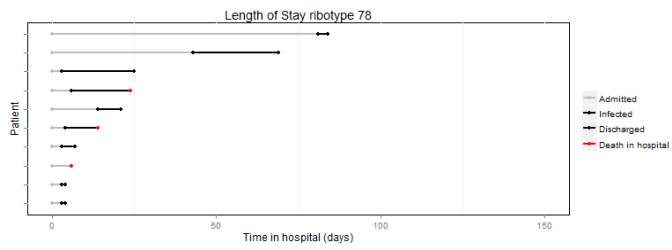
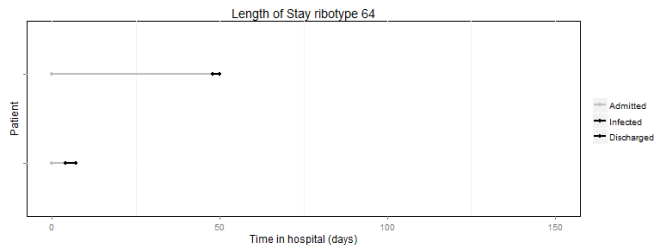
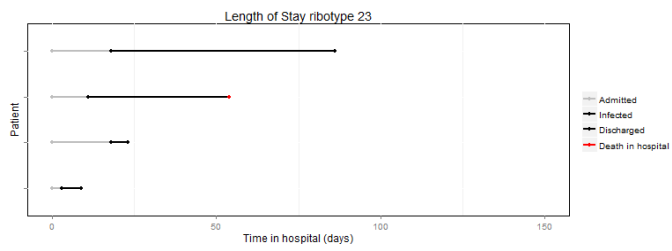
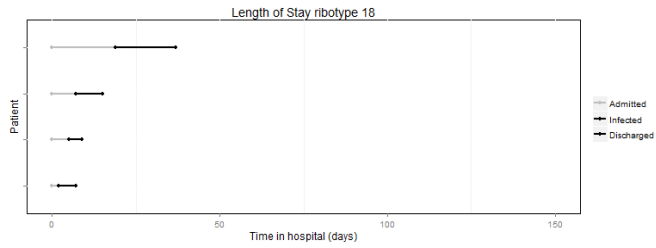
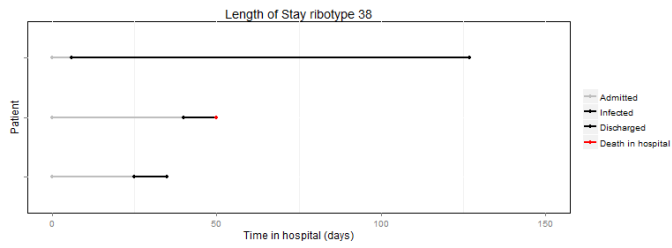

Supplementary figure 4: MSM weights

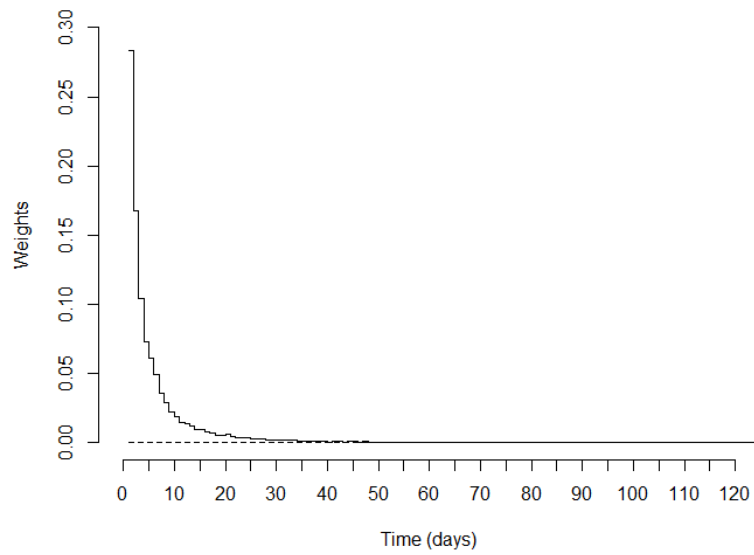

MSM weights, i.e. the average difference in LoS of patients of HA-CDI infected and non-infected patients across all days are weighted relative to the frequency of the possible events (i.e. HA-CDI, discharge alive and in-hospital death) on each day.

CHAPTER 5

MATHEMATICAL MODEL OF THE POPULATION-LEVEL EFFECT OF *CLOSTRIDIUM DIFFICILE* VACCINATION AS PART OF AN INTEGRATED INFECTION CONTROL STRATEGY

5.1 PREAMBLE TO RESEARCH PAPER 4

The previous chapters have provided considerable insight for choosing and parameterising an appropriate modelling framework with which to address our final research objective: to evaluate the effectiveness of infection prevention and control strategies involving vaccination in an English setting. In research paper three (Chapter 4), CDI was shown to place a significant hospital burden through increasing patients' hospital stay and mortality[1]. Therefore, if a CDI vaccine were able to prevent hospital-onset CDIs, it could have a marked impact. Within the hospital, although ICUs can vary markedly in their case mix, the critically ill, and often immunosuppressed status of ICU patients necessitates high levels of antimicrobial usage. Hence, this population has been described as at increased risk of CDI acquisition[2–4], and could therefore act as a marker for whether vaccination is likely to be a valuable hospital infection and prevention tool. We therefore chose to have the focus of the model centred on the ICU.

In research paper two (Chapter 3) it was shown that transmission from symptomatic carriers was present in English hospitals [5]. This justifies the use of a dynamic modelling framework to investigate the effectiveness of CDI vaccination in a hospital setting. Since the time of publication of research paper one, six additional dynamic transmission models have been published, in addition to the previous three mentioned. All nine models concerned hospital-spread of *C. difficile*, pre-dominantly using compartmentalised models[6-15], splitting the population into subgroups sharing particular characteristics of relevance for disease. A majority of the models assumed the hospital or ward population was resistant to colonisation and subsequent infection unless exposed to antibiotics [8, 9, 12, 13, 15]. As antimicrobial

usage remains the primary risk factor for CDI [16–18], and for the sake of model parsimony, incorporating such an assumption could be justified. A more recent model allowed individuals to become colonised and develop CDI without the traditional pre-disposing factors[10, 11]. However limited data were provided, hindering the verification of the model’s biological plausibility. Though such occurrences have been observed (see Chapter 1), the frequency of CDI among non-traditional risk groups is unknown.

Whilst admission and discharge from a homogenous source of individuals outside the hospital has been assumed in previous model frameworks[6, 8, 10–14], no model has incorporated readmission dynamics. As a consequence, all models, except one [6], have ignored relapse of CDI, for the primary reason that the probability of this occurring during the patient’s initial stay is low. This could be of relevance considering patients can remain colonised for an average period of one month or longer [19, 20]. One possible area where vaccination could be effective is in preventing recurrent disease (defined as relapse), as suggested by Lee *et al.*[21]. Vaccination may also aid in preventing re-infection among frequently hospitalised patients. Moreover, the high prevalence of *C. difficile* carriage observed in LTCFs [22], suggests distinguishing between admissions from general community populations and LTCF populations should perhaps be considered in the evaluation of the impact the effectiveness of vaccination. In an individual-based model, patients can be tracked separately over time. Therefore this approach allows for the incorporation of readmission dynamics, as well as the incorporation of heterogeneity in risk factors associated with infection, such as observed higher levels of antibiotic usage in LTCF populations as compared to community populations[23–26]. Unfortunately, the lack of data on CDI incidence in settings outside the hospital (Chapter 1) limit the possibilities for incorporating a long-term feedback loop between these settings, as was suggested in research paper one[27].

In this chapter, evidence generated from research paper one, two and three are combined to develop a mathematical dynamic transmission model to investigate the spread of nosocomial *C. difficile*, and evaluate the effectiveness of infection prevention and control strategies involving vaccination in an English setting. Extensive analysis of English national datasets and local level data from individual hospitals was conducted to inform key parameters and simulate the English ICU-setting as closely as

possible. Vaccine performance is evaluated under different strategies using the developed transmission dynamic model. Moreover, as shown in research paper two (Chapter 3), cross-transmission from symptomatic patients explained just a fraction of the variation in weekly CDI incidence observed. Hence, there remains considerable uncertainty around the alternative routes of CDI acquisition. To account for this, we performed scenario analysis, exploring the potential role of transmission from asymptomatic carriers. Similarly, to account for variation among ICUs with regards to levels of CDI risk, vaccine effectiveness is modelled under different scenarios of antibiotic usage and levels of cross-transmission. Hence, Chapter 5 meets objective four, as well as the overall objective of this thesis.

5.2. RESEARCH PAPER 4

Mathematical model of the population-level effect of *Clostridium difficile* vaccination as part of an integrated infection control strategy

Esther van Kleef^{1,2*}, Sarah R. Deeny^{2,3}, Mark Jit^{1,2}, Barry Cookson⁴, Simon D. Goldenberg⁵, W. John Edmunds¹, Julie V. Robotham²

¹ *London School of Hygiene and Tropical Medicine, London, United Kingdom*

² *Modelling and Economics Unit, Public Health England, London, United Kingdom*

³ *Health Protection Research Unit in Modelling Methodology, Public Health England, London, United Kingdom*

⁴ *University College London, London, United Kingdom*

⁵ *Guy's & St Thomas' NHS Foundation Trust and King's College, London, United Kingdom*

Publication status: In preparation

Registry

T: +44(0)20 7299 4646
F: +44(0)20 7299 4656
E: registry@lshtm.ac.uk

RESEARCH PAPER COVER SHEET

PLEASE NOTE THAT A COVER SHEET MUST BE COMPLETED FOR EACH RESEARCH PAPER INCLUDED IN A THESIS.

SECTION A – Student Details

Student	Esther van Kleef
Principal Supervisor	W.J Edmunds
Thesis Title	Modelling studies of the transmission-dynamics and hospital burden of Clostridium difficile

If the Research Paper has previously been published please complete Section B, if not please move to Section C

SECTION B – Paper already published

Where was the work published?	N/A		
When was the work published?	N/A		
If the work was published prior to registration for your research degree, give a brief rationale for its inclusion	N/A		
Have you retained the copyright for the work?*	Choose an item.	Was the work subject to academic peer review?	Choose an item.

**If yes, please attach evidence of retention. If no, or if the work is being included in its published format, please attach evidence of permission from the copyright holder (publisher or other author) to include this work.*



SECTION C – Prepared for publication, but not yet published

Where is the work intended to be published?	Clinical Infectious Diseases
Please list the paper's authors in the intended authorship order:	Esther van Kleef, Sarah R. Deeny, Mark Jit, Barry Cookson, Simon D. Goldenberg, W. John Edmunds, Julie V. Robotham
Stage of publication	Not yet submitted

SECTION D – Multi-authored work

For multi-authored work, give full details of your role in the research included in the paper and in the preparation of the paper. (Attach a further sheet if necessary)	he research question of this study was defined in a research proposal developed by WJE, MJ and JVR and granted by the Healthcare Infection Society (U.K. Registered Charity No. 286064). The candidate has developed the methodological design of the study in close consultation with JVR, MJ, SRD and WJE, and developed the model code. The
--	--

	<p>candidate has liaised with the necessary parties to acquire the data sources used. Moreover, the candidate has reviewed and extracted data from the literature for model parameterisation. CDI data from an ICU setting was provided by a large London hospital and explained by SDG. Advice on the biological plausibility as well as the clinical accurateness of the model has been given by BC and SDG. The candidate, in close consultation with JVR and SD, as well as MJ and WJE conducted the analysis for model parameterisation. Statistical advice for the probabilistic sensitivity analysis was provided by MJ. The candidate has interpreted the findings in collaboration with JVR, MJ, SRD and WJE. The candidate wrote the chapter with significant contributions from all co-authors.</p>
--	--

Student Signature:  **Date:** 19 November 2015
Supervisor Signature:  **Date:** 19 November 2015

Abstract

Background: Early clinical trials of a *C. difficile* toxoid vaccine show efficacy in preventing individual infection (CDI). However, the population-level impact of vaccination remains unknown. This study performed a model-based evaluation of the effectiveness of CDI infection control strategies involving vaccination, including potential indirect effects (prevention of onward transmission of the bacteria).

Methods: A state-of-the-art dynamic model of CDI, simulating transmission and control on an individual-patient level, with a focus on the Intensive Care Unit (ICU), was developed. The model incorporated data on patient movements between the hospital, community and long-term care facility (LTCF), using English national datasets and local level data from individual hospitals for model-parameterisation. We evaluated vaccination of: 1) patients with a previous CDI-occurrence in the ICU; 2) LTCF-residents; 3) Planned surgical admissions and 4) All three strategies combined.

Findings: In our baseline scenario, 10.8 patients per 1000 admissions developed CDI in the ICU, of which 31% was ICU-acquired. Immunising all three patient groups resulted in a 43% [interquartile range (IQR) 42 – 44], reduction of ICU-onset CDI on average. Among the strategies restricting vaccination to one target group, vaccinating elective patients proved most effective (35% [34–36] reduction), but required 146 [133 – 162] doses to prevent one case of CDI. Immunising LTCF residents was most efficient, requiring 14 [11 – 17] doses to prevent one case, but only reduced ICU-onset CDI by 9% [7 – 11]. Ward-based transmission rates, antimicrobial consumption and the transmission potential of asymptomatic carriers had significant effects on CDI incidence in the population, and therefore effectiveness and efficiency of the vaccination strategies.

Conclusions: Vaccination can aid markedly in CDI prevention. Strategy success depends on the interaction between hospital and catchment populations, and importantly, consideration of importations from elsewhere which we find to substantially impact hospital dynamics. The contribution of asymptomatic carriers to *C. difficile* acquisition should be an area of future investigation, as well as careful examination of groups at high risk for colonisation on admission and subsequent healthcare-onset CDI. Vaccination may be most effective in settings or patient groups where antimicrobial stewardship has not been (or can not be) implemented successfully.

Introduction

Clostridium difficile is a Gram-positive, spore forming bacterium that is an important cause of gastrointestinal infection in Europe[28]. Since 2007, *C. difficile* infections (CDIs) have dropped dramatically in England, from 55,489 cases reported across the National Health Service (NHS) and 9.4 cases per 10,000 bed days to 13,361 cases and 3.9 per 10,000 bed days in 2014/15[29]. Similar trends and rates are seen in other European countries[30], whereas in the US, despite observed reductions, incidence rates remain generally high, with nine hospital-onset cases reported per 10,000 bed days in 2014[31].

Prevention and control of CDI aims to reduce the organism's acquisition and spread. Measures include environmental cleaning, isolation and hand hygiene, as well as efforts to decrease patients' susceptibility to CDI, primarily through improved antimicrobial stewardship[32, 33]. Recently, vaccines targeting two *C. difficile* toxins (TcdA and TcdB) have been developed[34–37] and, following promising results in phase I and II clinical trials[34, 38], Phase III trials are now underway[39]. These vaccines induce an IgG antibody response and therefore aim to prevent infection in colonised individuals[34, 40–43]. A successful vaccine that prevented the primary, or recurrent, onset of CDI would directly reduce morbidity and mortality in the vaccinated individual but should also have a population-level effect, by reducing the spread of infectious spores from infected individuals into the environment, and thus preventing onward transmission of the bacteria. However, current evidence, based on highly discriminatory genetic typing-methods[44–46] as well as statistical modelling[5], suggests patients with symptomatic CDI are not the only contributors to hospital-onset CDI[47–49]. Such research makes it unclear which patient groups would be optimal to target with a *C. difficile* vaccine to prevent onward transmission and the development of CDI. Therefore, any examination of the overall impact of vaccination needs to account for *C. difficile* transmission, including the potential role of asymptomatic carriers [47–49].

CDI places a substantial burden on healthcare systems, and previous economic burden studies of CDI have shown that direct healthcare costs due to excess length of hospital stay (LOS) were the main cost drivers of the infection[50–52]. Within the hospital, patients in the intensive care unit (ICU) are likely to benefit from additional CDI prevention measures, considering their increased risk for CDI[16, 53, 54].

Although ICUs can vary markedly in their case mix, their critically ill status often causes a state of immunosuppression[55], and requires high levels of antibiotic prescribing[56]. Other risk factors associated with CDI, such as gastro-acid suppressants are frequently prescribed among ICU patients[57].

The elderly in long term care facilities (LTCF) are another high-risk population. Although there is no routine systematic surveillance of CDI in LTCF, nor is CDI testing performed routinely in this setting, evidence from individual LTCFs[22] have shown that carriage rates are high among these elderly residents. Admissions from LTCF have been associated with increased risk of hospital-onset CDI[58] and residing in a LTCF has been identified as an independent risk-factor for developing CDI[59]. Therefore, this group of individuals has been suggested as a potential target population for vaccination, as have elderly patients with planned elective surgery who share many of the underlying risk factors (frailty, hospital admission and antimicrobial usage) in common with the LTCF cohort [39]. Moreover, considering about 20% of CDI patients experience recurrent CDI[60], either due to re-infection or relapse[61], and primarily as a result of continued exposure to factors disturbing the gut flora post identification of CDI[62], patients with a history of CDI are a potential third target group for vaccination.

Transmission dynamic mathematical modelling is a well-established tool that can be used to extrapolate vaccination trial results to the population-level[63, 64]. In the case of *C. difficile* these methods would allow the exploration of vaccination while taking into account the different modes of acquisition[65]. To date, only a few attempts have been made to investigate the spread of *C. difficile* in the hospital setting by the application of dynamic-transmission models[6, 8–13, 15, 27]. One modelling study suggested that CDI vaccination could be cost-effective in preventing initial CDI in situations of relatively high CDI acquisition risk and/or low vaccine costs, but primarily in terms of recurrent CDI[21]. However, this study did not account for the indirect (i.e. population-) effects, nor investigated specific target groups for vaccination (other than (unspecified) patients at risk and patients with an earlier episode of CDI).

The prevention of CDI through vaccination is likely to have the greatest impact on the health and economic burden of CDI when hospital-onset is prevented, in the ICU in particular. We thus investigated the effectiveness of the four strategies described below, in terms of preventing CDI in the

ICU. A dynamic transmission model was developed, that accounted for potential population-effects, as well as uncertainties related to the epidemiology of CDI.

Methods

Model framework

A discrete-time, individual-based, stochastic, dynamic transmission model[66] was developed, simulating the transmission and control of CDI in a hypothetical 30-bed ICU in England serving a community of 100,000 individuals. Individual patient movements between the ICU, the hospital, surrounding community and long-term care facilities (LTCF) were modelled (see Figure 15 for model schematic).

Figure 15: Model framework

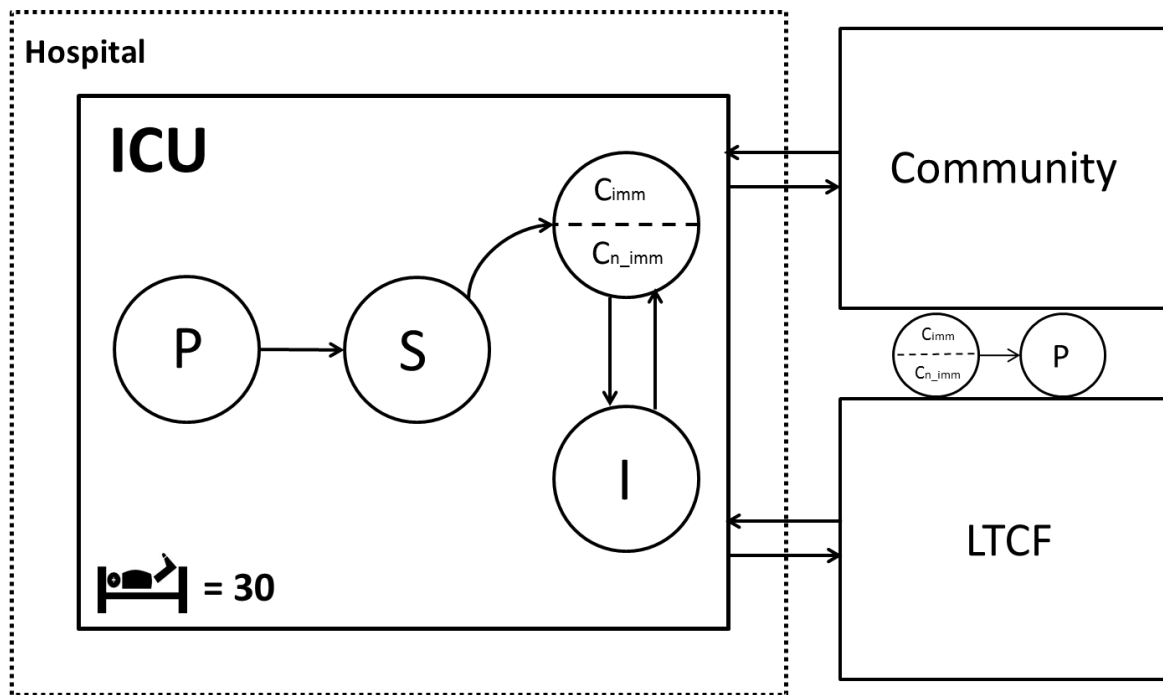

P = Patients protected from colonisation, hence infection; **S** = Patients susceptible to colonisation, hence infection; **C_{imm}** = Patients colonised with *C. difficile* that mount an immune response; **C_{n_imm}** = Patients colonised with *C. difficile* that fail to mount an immune response; **I** = Patients with CDI; **LTCF** = Long-term care facility

Patients with a normal gut flora were assumed protected against *C. difficile* colonisation (represented by compartment P in Figure 15). Consumption of ‘high risk’ antimicrobials (defined as broad-spectrum penicillins, third generation cephalosporins, clindamycin, and quinolones) was assumed to result in susceptibility to colonisation (compartment S) because of their deleterious effect on the microbiota[67–69]. Each day, susceptible patients (S) could become colonised with *C. difficile* through transmission, with the daily risk of colonisation (λ_t) increasing linearly with the number of transmitting CDI patients in the ICU ward (Table 7). The per day probability of colonisation, given at least one CDI or colonised patient on the ICU described the likelihood of transmission through direct contact between susceptible and infectious patients, and indirect contact between susceptible patients, contaminated staff and the environment. It was assumed that contacts (with patients, staff or the environment) occurred randomly and were homogenously distributed among patients.

Table 7: Model parameters and assumptions

Parameter	Description	Base value	Source
Transmission parameters			
β_1	Probability of transmission from infected patients, per day	0.0074	Fitted#
β_2	Probability of transmission from colonised patients, per day	0.0037	Fitted#
λ_t	Probability of a susceptible patient becoming colonised, per day	$1-(1-\beta_1)^I(1-\beta_2)^{C_t}$	
Patient parameters			
θ	Incubation time (days)	18 (Gamma)	[44, 48]
s	Duration of symptoms (days)	4 (Poisson)	[20, 44, 70]
c	Duration of colonisation (days)	30 (Exponential)	[19, 71]
L_{icu}	Average length of ICU stay	6	[72]
α_{gm}	Fraction of patients admitted from GM on antimicrobials on admission to the ICU	0.081	PPS[73]*#
α_{icu}	Fraction of patients on antimicrobials in the ICU on a given day	0.219	PPS[73]*#
p_{icu}	Probability of initiating high risk antimicrobials in ICU ward per day	$p_{icu} = 1-(1-\alpha_{icu})^{1/L_{icu}}$	
α_{ltcf}	Fraction of patients directly admitted from LTCF on antimicrobials on admission to the ICU	0.040	PPS[25, 26]*
α_{com}	Fraction of patients directly admitted from the community on antimicrobials on admission to the ICU	0.012	PPS[23, 24]*
$f_{ltcf} = f_{com}$	Fraction of patients admitted to ICU from the LTCF/ community that develop a natural immune response against disease	0.240	[74]*
a_{i_ltcf}	Fraction of patients from LTCF that were infected on admission to the ICU	0.050	H*
a_{c_ltcf}	Fraction of patients from LTCF that were colonised on admission to the ICU	0.010	H*

a_{s_ltcf}	Fraction of patients from LTCF that were susceptible on admission to the ICU	$a_{ltcf} - (a_{i_ltcf} + a_{c_ltcf})$	-
a_{i_com}	Fraction of patients from the community that were infected on admission to the ICU	0.003	H
a_{c_com}	Fraction of patients from the community that was colonised on admission the ICU	0.028	H
a_{s_com}	Fraction of patients coming from the community that was susceptible on admission to the ICU	$(1 - a_{ltcf}) - (a_{i_com} + a_{c_com})$	-
Movement parameters			
a_{ltcf}	Fraction of patients admitted from LTCF	0.040	PPS[75]
a_{direct_icu}	Fraction of patients admitted directly into ICU from any community setting	0.510	HES
$a_{elect_icu_ltcf}$	Fraction of patients in the ICU that were admitted for elective surgery from LTCF	0.110	HES
$a_{elect_icu_com}$	Fraction of patients in the ICU that were admitted for elective surgery from community	0.300	HES
d_n	Daily probabilities of discharge from the ICU for protected, susceptible and asymptomatic patients	Supplementary table 5	[72, 76]
d_i	Daily probabilities of discharge from the ICU for infected patients	Supplementary table 5	[72, 76, 77]
μ_n	Daily probabilities of death in the ICU for protected, susceptible and asymptomatic patients	Supplementary table 5	[72, 76]
$\mu_i = \mu_n$	Daily probabilities of death in the ICU for infected patients	Supplementary table 5	[72, 76, 77]
r_{ltcf}	Probability of readmission for LTCF residents within three months	0.220	HES
r_{com}	Probability of readmission for community residents within three months	0.120	HES
τ	Mean time between discharge and readmission (days)	29 (Exponential)	HES
Vaccination parameters			
e	The probability of vaccination resulting in successful acquired immunity (vaccine efficacy)	1	A#
ε	Duration of vaccine-acquired immunity (years)	2	A
$a_{elect_hospital}$	Fraction of hospital admission that are elective	0.504	HES[78]
a_{icu}	Fraction of hospital admissions that involve an ICU stay	0.018	HES[79]
B_{ltcf}	Median number of beds per LTCF	37	CQC
N_{ltcf}	Total number of LTCFs in England with a size of ≥ 20 beds	8,639	CQC
N_{trust}	Total number of acute Trusts reporting ICU records in England	143	HES[79]
t	Simulation time (years)	5	-

* Included in probabilistic sensitivity analysis; # Included in scenario analysis. PPS = Point prevalence survey data (reference provided refers to which point prevalence data); H= Individual hospital data; HES = Hospital Episode Statistics; A = Assumption, CQC = Care Quality Commission data

A proportion of patients can mount a natural immune response against *C. difficile* toxins, and are protected from infection[80, 81]. Therefore, a distinction was made between patients that remained asymptomatic (compartment C) and those that suffered from infection (compartment I) following an incubation period. After successful treatment, patients lost their infection status but remained colonised with *C. difficile*. Colonisation status was lost after an average period of four weeks[19, 71]. About 20% of

patients experience recurrence[60, 61]; either due to re-infection or relapse[61], primarily as a result of continued exposure to factors disturbing the gut flora post identification of CDI[62]. To simulate relapse whilst still colonised, the model allowed recovered patients to have another episode of CDI following successive antimicrobial use but without transmission from another patient. Finally, post vaccination, patients are assumed protected from disease, however not from colonisation[81, 82].

Model assumptions

- 1) 100% bed occupancy was assumed, i.e. discharge or death of a patient resulted directly in the admission of a new patient.
- 2) Daily time-steps were used with patient discharges from the ward occurring at the beginning of each day.
- 3) Patients could be admitted from the community or from a LTCF. Patients either resided in a LTCF or the community for the full simulation period (five years).
- 4) At time of admission, a data-informed probability (Table 7) determined whether the ICU admission was directly from outside the hospital (i.e. from LTCF or community) or an internal hospital transfer. The source of the admission determined the probability of having been prescribed antimicrobials outside the ICU.
- 5) Transmission-events were simulated in the ICU, whereas a fixed importation rate of colonised and infected individuals from the community and LTCF was assumed. The time spent elsewhere in hospital (and thus the transmission elsewhere in hospital) prior to ICU admission is not captured in the model. However the importation rates were informed by ICU admission data (see model parameterisation), therefore implicitly incorporated acquisition during the time spent elsewhere in hospital.
- 6) Patients could be discharged whilst still colonised with *C. difficile*. Once discharged, colonised patients recovered from *C. difficile* colonisation at a constant rate (Table 7) irrespective of whether they were immunised.
- 7) The vaccine did not protect patients from colonisation. Vaccine derived immunity was assumed to last for a period of two years (internal communication with Sanofi Pasteur).

Intervention strategies

We considered the following four strategies, comparing each to no vaccination (strategy 0):

- 1) Vaccination of patients who have experienced an episode of CDI in the ICU, at the time of discharge from the hospital, as they are at risk of experiencing recurrent infection;
- 2) Vaccination of LTICF residents in the catchment area of the hospital irrespective of whether they are to have planned elective surgery[39];
- 3) Vaccination of patients with planned elective surgery in the hospital catchment area [39].
- 4) Vaccination of all the above listed patient groups.

Model output

The absolute reduction in number of cases per 1000 admissions for each strategy compared to a strategy without vaccination (strategy effectiveness) was evaluated, as well as the number of doses required to avert one case in the ICU (strategy efficiency). Patients who acquired *C. difficile* colonisation in the ICU, and did not mount a natural or acquired immune response, but were discharged from the ICU pre-symptom-onset, were defined as new infections without ICU-onset. *C. difficile* imported in the ward comprised either community-acquired cases or cases readmitted to the ward after a colonisation/infection acquired in a previous ICU stay.

Scenario analysis

There exists considerable uncertainty in the transmission rates of *C. difficile*. Considering the current uncertain role of asymptomatic carriers in the transmission of *C. difficile*[46, 83], three assumptions were simulated, covering the transmission potential from these carriers as follows:

- 1) Asymptomatic carriers transmitted at half the rate of symptomatic carriers (2:1); the “base case”;
- 2) Asymptomatic carriers did not spread *C. difficile* (1:0);
- 3) Asymptomatic carriers transmitted as efficiently as symptomatic carriers (1:1)

In addition, ICU-based acquisition rates of CDI vary across the country (median 0.8 [interquartile range: 0 – 2.1] per 1000 patient days) in 2013/14[84]. This could relate to heterogeneity in levels of successful infection prevention and control, or regional differences in prevalence of more transmissible strains such as BI/NAP1/027[85, 86]. To represent different hospital settings (see Model Parameterisation for analysis), intervention effectiveness was evaluated assuming:

- 1) Average levels of transmission according to these estimates (AT); the “base case”
- 2) High levels of transmission (HT).

On analysis of national data[73], hospitals and ICUs across the country vary in their antimicrobial prescribing practices (see Model Parameterisation for analysis). To consider this between-ICU heterogeneity in antimicrobial consumption, the following scenarios were simulated and the effectiveness of vaccination evaluated in both settings:

- 1) Average antimicrobial use (AA), the “base case”;
- 2) Low antimicrobial use (LA).

Given that currently any CDI vaccine is currently still facing clinical trials; the efficacy of a CDI vaccine is unknown. To account for this, vaccine performance was evaluated under:

- 1) High vaccine-efficacy (100%), the “base case”;
- 2) Medium vaccine-efficacy (70%);
- 3) Low vaccine-efficacy (50%).

Combinations of the above listed possibilities were simulated under the base case assumption for asymptomatic carriers (Symptomatic/ Asymptomatic transmissions (2:1)), representing the following ICU scenarios:

- **Scenario 1:** Average transmission (AT) + Average antimicrobial use (AA) + High vaccine-efficacy (100%); the “base-case” scenario
- **Scenario 2:** High transmission (HT) + Average antimicrobial use (AA) + High vaccine-efficacy (100%);

- **Scenario 3:** Average transmission (AT) + Low antimicrobial use (LA) + High vaccine-efficacy (100%);
- **Scenario 4:** High transmission (HT) + Low antimicrobial use (LA) + High vaccine-efficacy (100%);
- **Scenario 5:** Average transmission (AT) + Average antimicrobial use (AA) + Medium vaccine-efficacy (70%);
- **Scenario 6:** Average transmission (AT) + Average antimicrobial use (AA) + Low vaccine-efficacy (50%);

In addition, the impact of the assumed transmission potential of asymptomatic carriers was investigated by simulating scenario 1 and 2 with the two alternative assumptions regarding asymptomatic transmission. The first – asymptomatic carriers did not spread *C. difficile* (1:0); and the second – asymptomatic carriers transmitted as efficiently as symptomatic carriers (1:1). In Supplementary table 3 the values used to represent these scenarios are given. Estimation of these values is further explained in the model parameterisation section.

Probabilistic Sensitivity Analysis

Uncertainty in parameter values other than asymptomatic transmission (see Table 7 for which parameters this concerned) was simulated using probabilistic sensitivity analysis, that is running the simulations multiple times with parameter values sampled from their distributions (Supplementary table 4) using Latin hypercube sampling (LHS)[87] as follows. One thousand random samples were drawn covering the whole range of possible values for each parameter equally and combined at random to create 1000 different parameter sets. As the model was stochastic, a different result could be expected for a given parameter set. Hence the medians of 100 simulation runs per parameter set were combined to obtain the overall median and interquartile range (IQR) of the model output encompassing parameter uncertainty.

Model parameterisation

Table 7 summarises the model parameter values. These values were derived from new analysis of national and regional healthcare data and peer-reviewed research articles otherwise, discussed in more detail below.

C. difficile transmission parameters (β_1 and β_2)

Little is known about the transmission potential of patients infected or colonised with *C. difficile*. Therefore, the transmission potential from symptomatic carriers (β_1) and asymptomatic carriers (β_2) was fitted to the median CDI acquisition rates in English critical care units in the financial year 2012/13 as measured in the Intensive Care National Audit & Research Centre Case Mix Programme (ICNARC) data. This data comprises, among others, ‘potential performance indicators’, such as unit acquired CDI, of 202 NHS adult, general critical care units, defined as ICUs, combined ICU/high dependency units (HDUs) and combined general care/coronary care units admitting mixed medical/surgical patients predominantly aged older than 16 years[88].

The following three steps were applied. Firstly, we sampled 1000 parameter values for β_1 from a uniform distribution over range 0 to 1 (as negative values were considered biological implausible) using LHS and let β_2 depend on β_1 according to $\beta_2 = \beta_1/2$. Secondly, we ran the model for each of these 1000 values for β_1 and β_2 one hundred times (to minimise stochastic variation) whilst keeping all remaining model parameters at their base value (Table 7). Thirdly, we compared the median ICU-onset acquisition rates resulting from each set of one hundred model simulations against the median CDI acquisition rates in the ICNARC data, i.e. 0.8 [IQR: 0 – 2.1] per 1000 bed days[84], and evaluated which values of β_1 (and thus β_2) minimised the difference between the model output, and the data (Figure 16). This process was repeated for the two alternative assumptions for the transmission potential of asymptomatic carriers (i.e. 1:0 ($\beta_2=0$) and 1:1 ($\beta_2=\beta_1$)). Moreover, a similar step-wise process was followed for the scenario of high transmission, where β_1 and β_2 were fitted against the seventy-fifth percentile of the aforementioned CDI acquisition rates in the ICU, i.e. 2.1 cases per 1000 patient days (Figure 16).

Figure 16: Model output of 1000 values for β_1 (and $\beta_2 = \beta_1/2$; $\beta_2 = 0$ or $\beta_2 = \beta_1$)

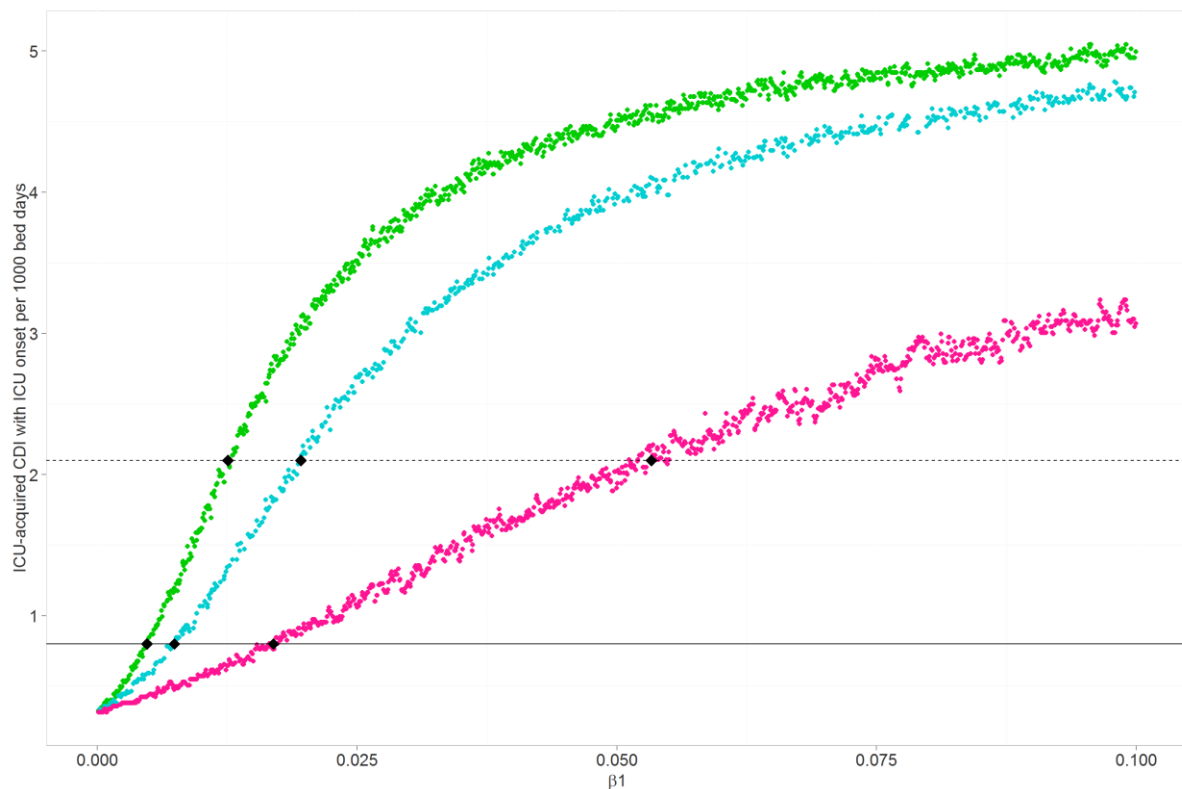

Solid horizontal black line: median CDI acquisition rates in English ICUs (ICNARC data), representative for ICUs with average transmission. **Dashed horizontal black line:** seventy-fifth percentile of CDI-acquisition rates in English ICUs, representative for ICUs with high CDI transmission. **Blue dots:** Model output for each of the values of β_1 in the base case, where asymptomatic carriers have half the transmission potential compared to symptomatic carriers, i.e. $\beta_2 = \beta_1/2$ (scenario 2:1). **Pink dots:** Model output for each of the values of β_1 in the scenario where asymptomatic carriers have no transmission potential, i.e. $\beta_2 = 0$ (scenario 1:0). **Green dots:** Model output for each of the values of β_1 in the scenario where asymptomatic and symptomatic carriers have equal transmission potential, i.e. $\beta_2 = \beta_1$ (scenario 1:1). **Lower black dots:** Best fit for β_1 (and implicitly for β_2) for each of the three asymptomatic transmission scenarios when transmission levels are at national average. **Upper black dots:** Best fit for β_1 (and implicitly for β_2) for each of the three asymptomatic transmission scenarios when transmission levels are high compared to the national average.

Daily discharge and death probabilities (d_n , d_i , μ_n and μ_i)

Estimates for ICU-specific daily discharge probabilities and mortality risks for CDI-negative patients and asymptomatic carriers (d_n and μ_n respectively) were derived from studies estimating these parameters for MRSA negative patients [72, 89], under the assumption that these MRSA negative patients did not suffer from CDI. For daily discharge probabilities of CDI positive patients (d_i) the daily discharge probabilities of CDI-negative patients were reduced by 28%, based on the findings of the previously presented Cox proportional hazards model estimating excess LoS associated with CDI [76] (see Chapter

4). These discharge probabilities were estimated using whole hospital data. A review of the literature identified two studies on excess length of stay (LoS) and mortality associated with CDI in the ICU specifically using appropriate methods [77, 90]. Using a Cox proportional hazard model, one study found reduced daily discharge probabilities for CDI patients as well (HR: 0.82 [95%CI 0.72 – 0.94]). The second study used a multistate model and found an excess ICU stay of 6 days (6.3 [2.0 – 10.6]) similar to our results. In contrast to our overall hospital estimate, both studies did not find an increased probability of death due to CDI in the ICU[77, 90]. Therefore, the daily risk of death in our model for CDI negative (μ_n) and CDI positive (μ_i) were assumed identical (Supplementary table 5)

Antimicrobial prescribing in the hospital setting (α_{icu} , α_{gm} and p_{icu})

In the model, patients could be either admitted directly to the ICU from a community-setting (i.e. LTCF or community), or as a result of an internal-hospital transfer, from a GM ward. Therefore, the prescribing prevalence for GM (α_{gm}) needed to be obtained, in addition to the daily risk of being prescribed antimicrobials in the ICU (p_{icu}). To obtain the national prevalence of ward-prescribing in England, a mixed-effects logistic regression model, with a normally distributed random-intercept (to account for clustering on a Trust level) and ward specialty included as an explanatory variable, was fitted to individual patient-level antimicrobial consumption data from a nation-wide point prevalence survey on health-care associated infections and antimicrobial use[73]. For this survey, data was collected from 99 NHS acute Trusts in England on the number of patients on antimicrobials on the one single day the survey was conducted[73].

For the analysis, antimicrobial usage data was restricted to CDI-associated antimicrobial classes only, i.e. broad-spectrum penicillins, third-generation cephalosporins, clindamycin, and quinolones. The mean probability of being on CDI-associated (or ‘high-risk’) antimicrobials for each ward specialty on a random single day (α_w) was calculated using the logistic function, given by the inverse-logit:

$$\alpha_w = 1/(1 + \exp(-x_w)), w = GM, ICU \quad (\text{Equation 1})$$

where x_w corresponds to the estimated regression coefficients for each ward specialty (Supplementary table 6). The within-hospital variance (σ_w^2) of these estimates was used as a proxy for the

second-order uncertainty around α_w . In the earlier mentioned probabilistic sensitivity analysis, 1000 samples were randomly drawn from a normal distribution with mean = x_w and standard deviation = $\sqrt{\sigma_w^2}$ using LHS. As these estimates were fitted with a log-link, these 1000 randomly drawn samples were then transformed to the identity scale using equation 1. Considering x_w was fitted to hospital antimicrobial consumption data of one single day, α_w represents overall ward prescribing prevalence. This estimated prevalence for the GM ward was used to represent the risk of being on CDI-associated antimicrobials when admitted from a GM ward (α_{gm}) to the ICU in our model. However, as our model explicitly simulated CDI-transmission dynamics in the ICU, and in daily time steps, α_{icu} needed to be converted to a daily risk of being prescribed CDI-associated antimicrobials. Assuming each patient in the point prevalence data was receiving one CDI-associated antimicrobial only, and the average length of ICU stay (L_{icu}) was six days[76], we used the following:

$$\alpha_{icu} = 1 - (1 - p_{icu})^{L_{icu}} \quad (\text{Equation 2})$$

Where $1 - p_w$ is the risk of avoiding a CDI-associated antimicrobial prescription in the ICU per day. Equation 2 can be rearranged to calculate daily risks of starting on CDI-associated antimicrobials for each patient:

$$p_{icu} = 1 - (1 - \alpha_{icu})^{1/L_{icu}} \quad (\text{Equation 3})$$

Finally, for the scenario analysis, an alternative scenario of low hospital prescribing of CDI-associated antimicrobials was represented by the twenty-fifth percentile of these estimates' confidence intervals, calculated when including both the within ($\sqrt{\sigma_w^2}$) and between-Trust variation ($\sqrt{\sigma_{trust}^2}$) (Supplementary table 6).

Antimicrobial prescribing in the community and LTCF (α_{lcf} and α_{com})

The fraction of LTCF residents and patients admitted from the community that received CDI-associated antimicrobials prior to ICU admission (α_{lcf} and α_{com}) were parameterised by European Centre of Disease Control (ECDC) point prevalence antimicrobial consumption data from the United Kingdom (UK), collected through The European Surveillance of Antimicrobial Consumption Network in 2010 and

2011[23, 24] and the Healthcare Associated infections in LTCF (HALT) point prevalence studies of 2010 and 2013[25, 26]. These data report the Defined Daily Doses (DDD) of antimicrobials per 1000 individuals using the Anatomical Therapeutic Chemical (ATC) Classification System (<http://www.whocc.no>). DDD represent the assumed average maintenance dose per day for a drug used, for its main indication in adults. The ACT classification system is developed by the World Health Organisation and divides drugs according to their therapeutic, pharmacological and chemical properties using five different levels, where level 1 corresponds to the main group and level 5 to the chemical substance. The ECDC point prevalence survey results are reported at ATC level 4. The DDD per 100 population of the ATC level 4 groups J01D (other beta-lactam antibacterials); J01C (Beta-lactam antibacterials, penicillins); J01F (Macrolides, lincosamides and streptogramins); and J01M (Quinolone antibacterials) were combined to obtain an estimate of the proportion of patients receiving CDI-associated antimicrobials in the community and LTCF (Supplementary table 7).

Importation rates of colonised and infected patients (a_{i_ltcf} , a_{c_ltcf} , a_{s_ltcf} , a_{i_com} , a_{c_com} , a_{s_com})

The fraction of individuals admitted from the community/LTCF that were infected (a_{i_com}/a_{i_ltcf}), colonised (a_{c_com}/a_{c_ltcf}) or susceptible (a_{s_com}/a_{s_ltcf}) on admission were parameterised using ICU-screening data collected over 18 months from a 30-bed ICU ward in a large London teaching hospital[91]. The particular provenance status (i.e. community home or LTCF) of the patients was not collected as part of this study. As an alternative, it was assumed that 4% of the total admissions to the ICU were LTCF residents, as was shown by sentinel data collected from seven acute Trusts through The National One Week Prevalence Audit of MRSA[75]. For the patients that screened positive for colonisation and/or had symptomatic infection, provenance status was obtained by retrieval of the patients' postcodes of residence, which were subsequently matched with LTCF postcodes (using Care Quality Commission data further explained later)[92].

Using this procedure, 53 of the admissions originated from LTCFs, and 30 of these were screened for *C. difficile*. On admission, infection prevalence among patients admitted from their own home (a_{i_com}) was 0.3% (95%CI: 0.1 – 0.8) and colonisation prevalence (a_{c_com}) 2.8% (1.8 – 4.3), whereas this was 0% (0 – 11.4) and 0% (0 – 11.4) respectively for patients from LTCFs (Supplementary table 8).

As shown in Chapter 1, a recent systematic review of the literature showed a significantly higher weighted mean prevalence of asymptomatic carriage in LTCFs of 14.8% (95% CI 7.6 – 24.0), though did find high levels of heterogeneity among individual care homes.

For this reason, we constructed prior distributions for asymptomatic and symptomatic *C. difficile* importation rates from the LTCF, and updated them using the screening data. As a conservative estimate, it was assumed that importation rates of colonised (a_{c_ltcf}) and infected (a_{i_ltcf}) individuals from the LTCF could be 0-3 times higher than importations from the general community. Two beta distributions with shape parameters informed by the above screening data (Supplementary table 4) were used to represent community importation rates of infected and colonised cases respectively, whereas a triangular distribution (mode 1.5, min=0, max=3) represented the differences in importation rates between community and LTCF settings. Using LHS, 10,000 samples were randomly drawn from the beta and triangular distributions, and multiplied to obtain a prior distribution for a_{c_ltcf} and a_{i_ltcf} . The probability distributions of these priors were updated using the probability distribution of the data (i.e. LTCF importation rates according to the above screening data), represented by a binomial distribution ($k=0$ and $n=30$), in order to obtain posterior distributions for the desired importation rates (Supplementary table 4).

Patient movement parameters (a_{direct_icu} , $a_{elect_icu_ltcf}$, $a_{elect_icu_com}$, r_{ltcf} , r_{com} and τ)

Hospital Episode Statistics (HES) contains individual patient-level data for all admissions (i.e. spells) to NHS acute Trusts in England. A fraction of this data is publicly available through (<http://www.hscic.gov.uk/>). However, to inform parameters describing: the fraction of individuals that was admitted directly into the ICU (a_{direct_icu}); the fraction of ICU admissions that concerned LTCF/community patients that were originally admitted electively to the hospital ($a_{elect_icu_ltcf}/a_{elect_icu_com}$); the readmission rates of LTCF residents and patients admitted from their own home (r_{ltcf}/r_{com}) and mean time elapsed between ICU readmissions (τ), more detailed data was required. For this reason, a HES extract involving all admissions with at least one episode in the ICU (i.e. treatment specialty defined as ‘critical care’) from the financial year April 2012/13 to April 2013/14 was requested.

In HES, a hospital spell (i.e. hospital stay) contains multiple episodes, where a patient starts a new episode when treated by a consultant from a different treatment specialty. The proportion of patients that had their first episode defined as a critical care treatment specialty, informed the fraction of direct admissions into the ICU (a_{direct_icu}), which was used to calculate the risk of antimicrobial exposure outside the ICU as explained earlier.

The HES ‘admission method’ and ‘admission source’ data fields informed the fraction of ICU admissions that concerned LTCF/community patients that were originally admitted electively to the hospital. That is, $a_{elect_icu_ltcf}$ was the proportion of spells with an ‘*Elective*’ admissions method and the admission source coded as one of the following:

- 54) NHS run nursing home, residential care home or group home;
- 65) Local authority Part 3 residential accommodation: where care is provided (from 1996-97);
- 85) Non-NHS (other than Local Authority) run residential care home (from 1996-97);
- 86) Non-NHS (other than Local Authority) run nursing home (from 1996-97)
- 88) non-NHS (other than Local Authority) run hospice.

$a_{elect_icu_com}$ concerned all elective spells with admission source coded as:

- 19) The usual place of residence, including no fixed abode.

Readmission rates (r_{ltcf}/r_{com}) and readmission time (τ) were defined by the fraction of patients that had a readmission to the ICU within three months (considering the colonisation time of *C. difficile* is rarely found longer than three months[19, 71]), and the mean number of days between these readmissions.

Number of vaccines required for strategy 1 (Patients with a history of CDI in the ICU)

The number of vaccine doses required for strategy 1 (vaccinating patients that experienced an episode of CDI in the ICU, v_{CDI_Trust}), was calculated through a counting process incorporated in the model. Over the five year simulation time, for each patient, at the time of ICU-discharge, the model checked whether the patient had experienced an episode of CDI (which could have concerned either an

importation or an ICU-acquired infection) and if so, and the patient had not been vaccinated within the previous two years, added an additional vaccine dose to the cumulative total.

Number of vaccines required for strategy 2 (Patients admitted from a LTCF)

To calculate the number of vaccine doses required for strategy 2 (vaccinating residents of LTCFs), two publicly available data sources were used, held by the Care Quality Commission (CQC) and Health & Social Care Information Centre (HSCIC) respectively. The former comprises logistical data on English care homes, such as care home type, postcode and bed numbers[92]. HSCIC is the provider of England’s Hospital Episode Statistics (HES). Adult Critical Care data forms part of HES and provides details on the number of NHS acute Trusts with reported ICU records[79]. Hence, these datasets provided insight into 1) the total number of LTCFs in England, using the care home criteria for elderly residents as defined by the CQC (N_{ltof}); 2) the total number of acute Trusts with reported ICU admissions (N_{Trust}); and 3) the mean LTCF bed size (B_{ltof} , see Table 7 for parameter values).

Assuming all LTCFs and acute Trusts are homogenously scattered across the country, the number of residents requiring vaccination per acute Trust (R_{Trust}) was then defined by:

$$R_{Trust} = \frac{N_{ltof}}{N_{Trust}} B_{ltof} \quad (\text{Equation 4})$$

Our simulation period (t) comprised five years, and it was assumed a booster vaccine was needed every two years (ϵ). Provided that none of the LTCF was admitting new residents, the number of residents multiplied by the simulation period divided by the timing a booster vaccine was required gave the average number of vaccines required per acute Trust over the full simulation period.

$$v_{ltof_Trust} = R_{trust} \frac{t}{\epsilon} \quad (\text{Equation 5})$$

The model captured the transmission dynamics in the ICU, not elsewhere in hospital. As a result, using v_{ltof_Trust} as a measure for calculating the number vaccines required to prevent one healthcare-onset CDI case would underestimate the vaccine efficiency of this strategy. For this reason, we decided to adjust v_{ltof_Trust} for the proportion of admissions that included an ICU stay (a_{icu}). The total number of

ICU admissions per Trust in the financial year 2013/14[79] were divided and weighted by the total number of HES admissions[78] to obtain the weighted mean proportion of yearly admissions that comprised an ICU admission (a_{icu}). The average number of vaccines required per ICU over the full simulation period was then given by:

$$v_{ltcf_ICU} = a_{icu}v_{ltcf_Trust} \quad (\text{Equation 6})$$

Number of vaccines required for strategy 3 (Patients admitted for elective surgery)

For strategy 3 (vaccinating elective patients), only a small fraction of ICU admissions is planned[79]. However, elective hospital patients could experience an ICU episode during their hospital stay. Therefore, regardless of whether a vaccine would target ICU or high-risk hospital ward populations; this strategy will involve vaccination of all elective hospital patients.

To calculate the number of vaccine doses required for this strategy (v_{elect_Trust}), publicly available HES data was used. HES Admitted Patient Care data from 2013/14[78] provided detail on the total number of yearly admissions, and the yearly number of elective admissions per acute Trust. The mean of the latter multiplied by the simulation period represented the per acute Trust vaccine doses required for this strategy. For similar reasons as explained in the previous section, this number was scaled to the ICU setting using a_{icu} .

$$v_{elect_ICU} = a_{icu}v_{elect_Trust} \quad (\text{Equation 7})$$

Number of vaccines required for strategy 4 (all combined)

For strategy 4, as the three target groups were not mutual exclusive, v_{ltcf_ICU} , v_{ltcf_Trust} and v_{elect_ICU} were combined and deducted by the fraction of admissions that concerned LTCF patients (a_{ltcf}). Here, v_{CDI_Trust} was calculated as before, but with the model run under the assumption that all LTCF and elective patients were vaccinated, thus protected from developing CDI in the ICU.

Results

Simulation Results: Base Case Scenario

The vaccine impact (for four strategies) was first modelled using our base case scenario, where asymptomatic carriers are half as infectious as symptomatic carriers, the ward was assumed to have average transmission parameters, and antimicrobial prescribing was at the English national average, estimated as described in the methods section.

No vaccination

In the base case scenario, without vaccination (strategy 0), the median number of new symptomatic and asymptomatic *C. difficile* acquisitions in the ICU was 13.9 [IQR: 13.1–14.9] per 1000 admissions (Figure 17). 7.7 [6.8–8.6] became symptomatic, of which symptom-onset in the ICU occurred in 3.3 [2.9–3.7] cases per 1000 admissions (Figure 18).

Figure 17: Symptomatic and asymptomatic ICU-acquired *C. difficile* per 1000 admissions shown for all four vaccination strategies

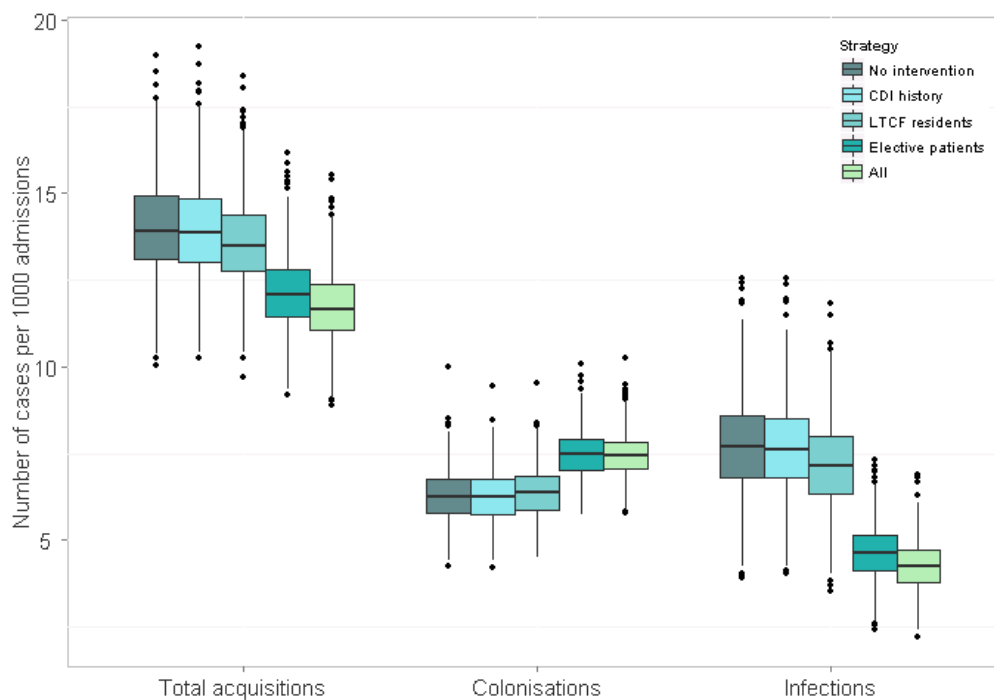

Model outcomes at baseline for **strategy 0** (no vaccination); **strategy 1** (CDI history); **strategy 2** (LTCF residents); **strategy 3** (elective patients) and **strategy 4** (all combined). The middle line in the box represents the median of 1000 model parameter sets, and upper and lower areas of the box indicate the seventy-fifth and twenty-fifth percentiles. **Left set of boxes:** Total ICU acquisitions (colonised and infected) per 1000 admissions for all strategies; **middle set of boxes:** Total ICU acquisitions that result in asymptomatic carriage (i.e. no symptom onset in- or outside the ICU) per 1000 admissions for all strategies; **right set of boxes:** Total ICU acquisitions that result in symptomatic infection (symptom onset in- or outside the ICU) per 1000 admissions for all strategies.

Figure 18: Absolute number of imported and ICU-acquired CDI cases in the ICU per 1000 admissions for all four vaccination strategies

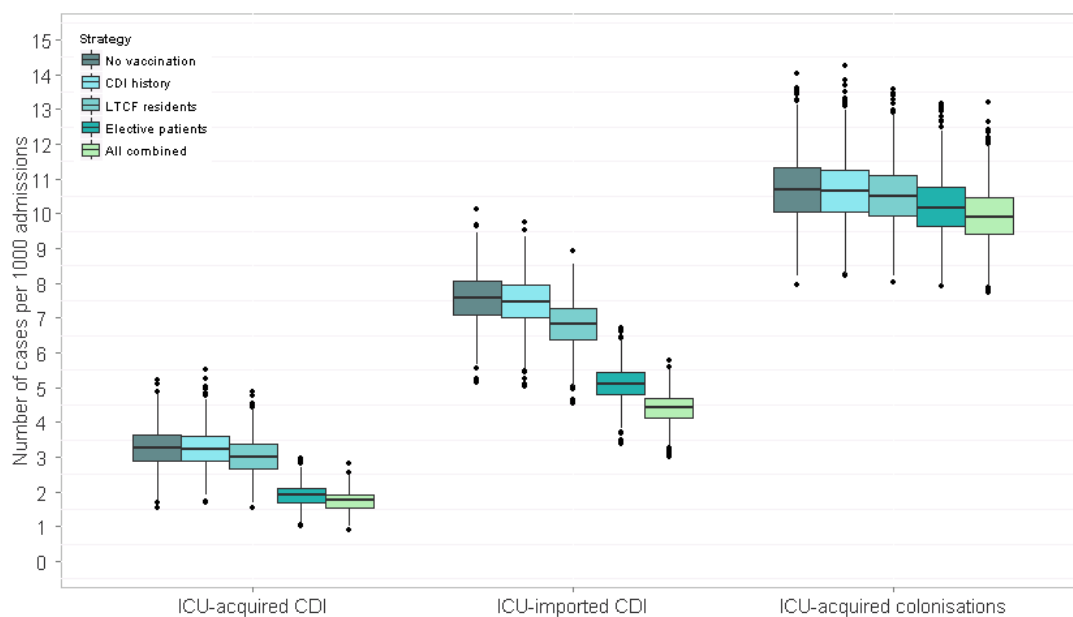

Model outcomes at baseline for **strategy 0** (no vaccination); **strategy 1** (CDI history); **strategy 2** (LTCF residents); **strategy 3** (elective patients) and **strategy 4** (all combined). The middle line in the box represents the median of 1000 model parameter sets, and upper and lower areas of the box indicate the seventy-fifth and twenty-fifth percentiles. **Left set of boxes:** ICU acquisitions that result in ICU-onset of symptoms per 1000 admissions for all strategies; **middle set of boxes:** ICU importations with ICU-onset of symptoms per 1000 admissions for all strategies; **right set of boxes:** ICU acquisitions that result in asymptomatic carriage (no symptom-onset in the ICU) over 1000 admissions for all strategies.

In addition, 7.5 infections per 1000 admissions were imported from outside the ICU. A low fraction (6.7%) of these were readmissions of patients who developed CDI in their current stay, following acquisition of *C. difficile* colonisation or infection during a previous ICU admission (Supplementary table 9).

Vaccine programme effectiveness

Vaccinating all target populations (strategy 4) resulted in a 43% [IQR: 42 – 44] reduction in ICU-onset cases over five years, equal to 4.7 [4.3 – 5.1] ICU-acquired and imported CDI cases per 1000 admissions when compared to strategy 0 (Table 8). Of the strategies restricting vaccination to one target group (strategies 1, 2 and 3), vaccinating all patients awaiting elective surgery (strategy 3) yielded the largest net reduction (35% [34–36] over a five-year period) in ICU-onset cases. Strategy 1 (vaccinating patients after recovery from a CDI episode in the ICU) saw a 1% [0 – 3] reduction over five years.

Vaccinating LTCF patients (strategy 2) saw a 9% [7 – 11] reduction in ICU-acquired and imported CDI over five years. For all four strategies, the majority of ICU-onset cases prevented were importations. This was particularly true for strategy 1 (80%) and 2 (76%) (Table 8).

Table 8: Number of ICU-onset cases prevented per 1000 admissions and doses required to avert 1 case of ICU-onset CDI for all scenarios

Scenario	Transmission Symptomatic: Asymptomatic (2:1)		
	ICU-onset CDI cases prevented/1000 admissions (Effectiveness)	Proportion of the ICU-onset cases prevented that were ICU-acquired	Doses required to avert one ICU-onset CDI case (scaled to ICU) (Efficiency)
Scenario 1 (AT + AA + VE = 100%)			
1) History of CDI in ICU	0.1 [0 – 0.3]	0.20	83 [33 – NA]
2) LTCF residents	1.0 [0.8 – 1.2]	0.24	14 [11 – 17]
3) Elective patients	3.8 [3.5 – 4.2]	0.36	146 [133 – 162]
4) All combined	4.7 [4.3 – 5.1]	0.34	124 [113 – 137]
Scenario 2 (HT + AA + VE = 100%)			
1) History of CDI in ICU	0.5 [0.2 – 0.8]	0.34	43 [27 – 115]
2) LTCF residents	1.6 [1.3 – 2.0]	0.50	8 [7 – 10]
3) Elective patients	7.9 [7.1 – 8.8]	0.64	72 [65 – 80]
4) All combined	9.4 [8.4 – 10.4]	0.61	63 [57 – 70]
Scenario 3 (AT + LA + VE = 100%)			
1) History of CDI in ICU	-	-	-
2) LTCF residents	0.8 [0.6 – 1.0]	0.19	17 [14 – 23]
3) Elective patients	2.8 [2.6 – 3.0]	0.29	199 [183 – 219]
4) All combined	3.5 [3.2 – 3.7]	0.26	168 [156 – 181]
Scenario 4 (HT + LA + VE = 100%)			
1) History of CDI in ICU	-	-	-

2) LTCF residents	1.1 [0.9 – 1.4]	0.40	12 [10 – 16]
3) Elective patients	5.0 [4.5 – 5.5]	0.56	112 [103 – 125]
4) All combined	5.9 [5.4 – 6.5]	0.54	99 [91 – 108]

Scenario 5 ($AT + AA + VE = 70\%$)

1) History of CDI in ICU	-	-	-
2) LTCF residents	0.8 [0.6 – 1.0]	0.24	17 [14 – 23]
3) Elective patients	2.8 [2.5 – 3.0]	0.37	204 [187 – 225]
4) All combined	3.4 [3.1 – 3.8]	0.34	171 [152 – 189]

Scenario 6 ($AT + AA + VE = 50\%$)

1) History of CDI in ICU	-	-	-
2) LTCF residents	0.6 [0.4 – 0.7]	0.23	23 [17 – 34]
3) Elective patients	2.0 [1.8 – 2.3]	0.36	283 [251 – 313]
4) All combined	2.6 [2.3 – 2.9]	0.33	228 [207 – 259]

We assumed that vaccination did not provide direct protection against *C. difficile* colonisation. Nonetheless, introduction of vaccination saw a decreased ward-based risk of patients acquiring both symptomatic and asymptomatic *C. difficile*. This can be seen by a reduction in the median total number of ICU-acquisitions of 3% [0 – 5], 13% [11 – 16] and 16% [14 – 18] for strategies 2, 3 and 4. Due to this population-effect of the vaccine, the reduction in the number of ICU-acquisitions that became symptomatic (either in the ICU or post-discharge) was higher than the increase in the number of ICU-acquisitions that resulted in colonisation for these three strategies (Figure 17). In the ICU, this meant that, post-vaccination, a reduction was observed in both ICU-acquired CDI, as well as colonisations (Figure 18), as, when no vaccination was introduced, a large proportion (42%) of patients that remained asymptomatic in the ICU, developed symptoms post-discharge.

Vaccine programme efficiency

Among the four strategies investigated, strategy 2 was the most efficient, i.e. required the lowest number of doses to avert one case of ICU-onset CDI in the base case scenario (Table 8). This was followed by strategy 1, but as this strategy included model simulations where no reduction was observed (considering the low number of readmissions of previously positive patients that experience subsequent onset, Supplementary table 9), this was also the most uncertain strategy. Strategy 3 required over ten times more doses than strategy 2, and hence was the least efficient. Finally, vaccinating all target groups required over eight times more doses than strategy 2 to prevent one case (Table 8).

Simulation Results: Scenario analysis

Vaccine impact (for four strategies) was modelled in six alternative scenarios, as shown in Table 8. In the following sections, vaccine performance in these scenarios in terms of effectiveness and efficiency is discussed.

Scenarios of high transmission

Among all six scenarios investigated, the CDI vaccination programmes proved most effective and efficient when transmission was high and antimicrobial usage was at the national average (scenario 2, see Table 8). Under these assumptions, without vaccination, the median number of new symptomatic and asymptomatic *C. difficile* acquisitions in the ICU was four times higher than in the base case scenario, i.e. 55.9 [IQR: 52.0 – 59.7] per 1000 admissions, of which 12.6 [11.2 – 14.0] had ICU-onset (Supplementary table 10).

As a result of the higher incidence in the ICU, the probability of previously colonised or infected patients being readmitted to the ICU increased (Supplementary table 10), resulting in five times more cases being prevented for strategy 1 compared to the base case (Table 8). Two times more ICU-onset cases were prevented through vaccination for strategies 3 and 4 (Table 8) as these strategies became more effective in preventing onward transmission (Figure 19). Strategy 2 became just 50% more effective. Hence, fewer doses of vaccine were required to prevent one CDI case in the ICU for strategies 1, 3 and 4 in particular, than were needed under base case assumptions. Nonetheless, in scenario 2, as well as among

all other scenarios investigated, vaccination of LTCF residents remained the most efficient strategy (Table 8).

Figure 19: Absolute number of imported and acquired cases prevented for strategies 1, 2, 3 and 4

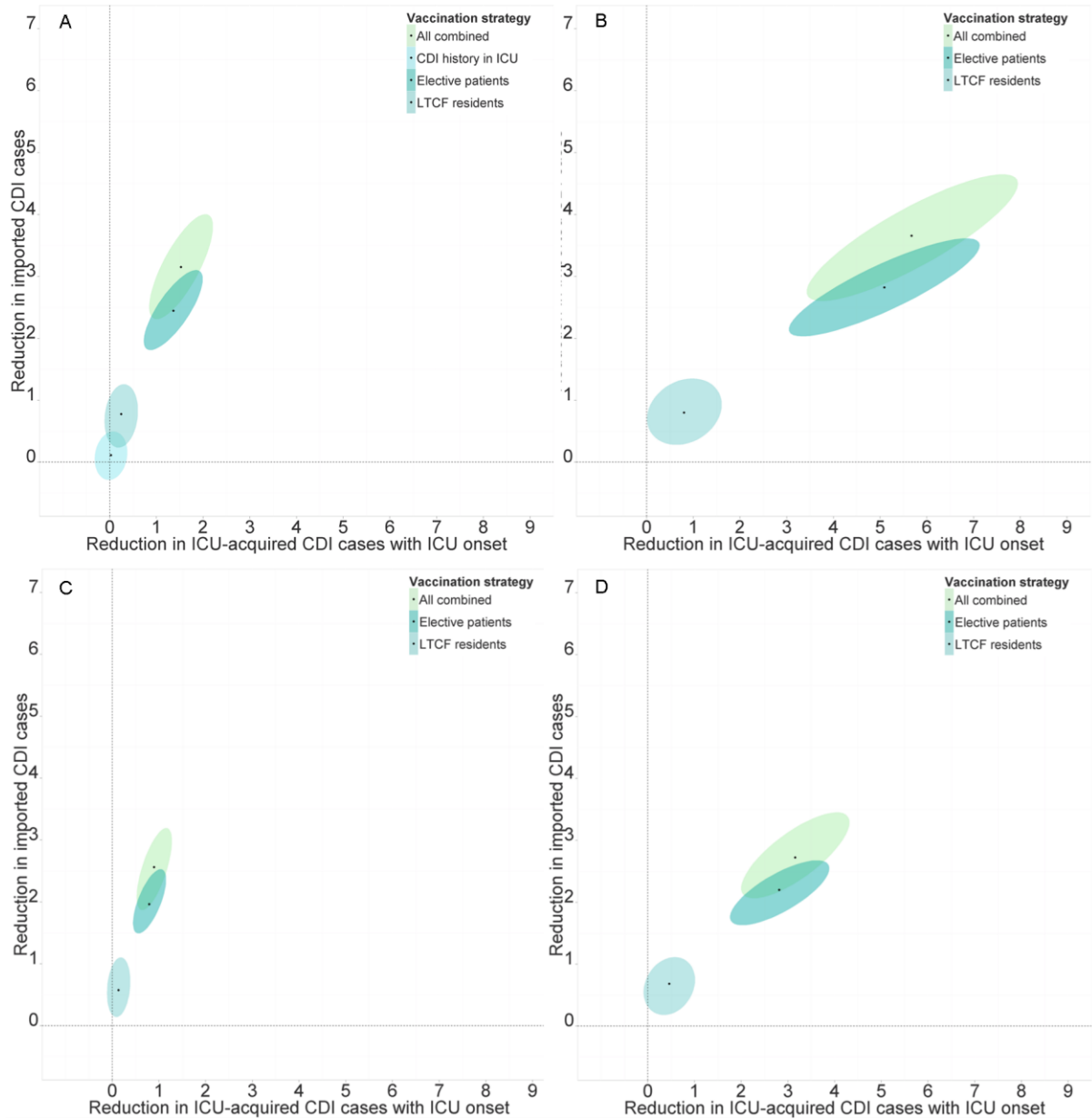

A: Model output in Scenario 1 (Base case); B: Model output in Scenario 2 (HT + AA + 100% VE); C: Model output in scenario 3 (AT + LA + 100% VE); D: Model output in scenario 4 (HT + LA + 100% VE)

The relative effectiveness of all strategies was only slightly higher compared to the base case, with a 45%, 38%, 8% and 2% reduction in ICU-onset CDI for strategy 4, 3, 2 and 1 respectively.

Scenarios of low antimicrobial consumption

In scenario 3, antimicrobial prescribing in the ICU (α_{icu}) and GM (α_{gm}) were reduced with 32% and 36% respectively. Consequently, without vaccination, the median number of new symptomatic and asymptomatic *C. difficile* acquisitions in the ICU was 25% lower than in the base case scenario, i.e. 8.3 [IQR: 6.7 – 9.6] per 1000 admissions, of which 2.0 [1.5 – 2.5] had ICU-onset (Supplementary table 11).

With such lowered levels of high-risk antimicrobial prescribing, vaccination reduced ICU-onset CDI incidence for strategies 2, 3 and 4 (Table 8), with close to similar relative reductions compared to the base case (9%, 34% and 42% respectively, i.e. a one percentage decrease for strategy 3 and 4). However, considering the lower incidence of ICU-acquired CDI incidence, strategies 3 and 4 required more doses in particular to avert one case (Table 8), as they prevented less onward-transmission (Figure 19). The impact of antimicrobial usage on these strategies efficiency was even further pronounced when transmission was high (scenario 4 compared to scenario 2, (Figure 19)).

Scenarios of low vaccine efficacy

With vaccine efficacy reduced to 50% (scenario 6), reductions in ICU-onset CDI were still observed. To illustrate, 24% of ICU-onset CDI cases were prevented in strategy 4, compared to 42% at the base case of 100% vaccine efficacy. However, with 64%, 94% and 84% more vaccine doses required for strategies 2, 3 and 4 respectively, the vaccine strategies' efficiency was significantly reduced (Table 8).

Simulation Results: impact of asymptomatic carriers

We simulated three scenarios for asymptomatic transmission, where the transmission from an asymptomatic case (relative to that from a symptomatic case) was varied, namely, 1) half as transmissible (the base case scenario), 2) no asymptomatic transmission, and 3) equally transmissible. This section discusses how the transmission potential of asymptomatic carriers interacts with the population-level effect of the vaccine.

Under all three scenarios for asymptomatic transmission, vaccination decreased the ward-based risk of *C. difficile* acquisition (symptomatic and asymptomatic) (Figure 20). Intuitively, post-vaccination,

reduction in ward-based acquisition was mostly seen when asymptomatic carriers were not transmitting (up to 51% [49 – 53] for strategy 4) as, under this assumption, by reducing the number of CDI cases in the ICU the transmission source was more successfully contained.

Figure 20: Total number of ICU-acquired cases (symptomatic and asymptomatic) per 1000 admissions shown for all four vaccination strategies, and all three assumptions for asymptomatic transmission

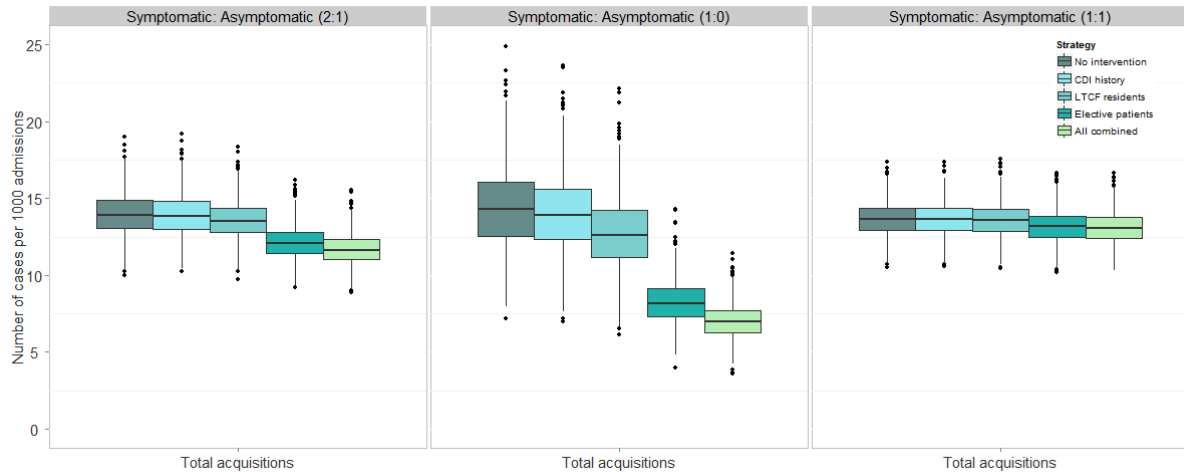

The middle line in the box represents the median of 1000 model parameter sets, and upper and lower areas of the box indicate the seventy-fifth and twenty-fifth percentiles. **1:0**: no asymptomatic transmission; **2:1**: asymptomatic carriers are half as transmissible compared to symptomatic carriers; **1:1**: asymptomatic and symptomatic carriers are equally transmissible.

However, when transmission of asymptomatic and symptomatic carriers was equal, this so-called indirect- or population-effect of vaccination was marginal, with a reduction of less than 4% for all strategies (compared to 16% in the base case, Figure 20).

As a result, under the equal asymptomatic transmission assumption, vaccination resulted in a slight increase of asymptomatic carriers (as the vaccine did not provide direct protection against colonisation) in the ICU for the most effective strategies 3 (6% [3 – 9]) and 4 (7% [4 – 9]), whereas under the base case and no asymptomatic transmission assumption, a decrease was observed (Figure 21A). Nonetheless, in terms of the CDI-onset cases prevented in the ICU, the efficiency was only less than 10% lower for all strategies (as shown in Supplementary table 12) under the equal transmission assumption compared to the base case asymptomatic transmission assumption.

In the scenario with no asymptomatic transmission, the marked decrease in ICU-acquisitions mentioned earlier resulted in a reduction in asymptomatic carriers in- and also outside the ICU. The latter was not observed under the base case asymptomatic transmission scenario (Figure 21B).

Figure 21: Change in symptomatic and asymptomatic ICU-acquired *C. difficile* per 1000 admissions shown for all four vaccination strategies, and all three assumptions for asymptomatic transmission; A) In the ICU; B) In- and outside the ICU

A

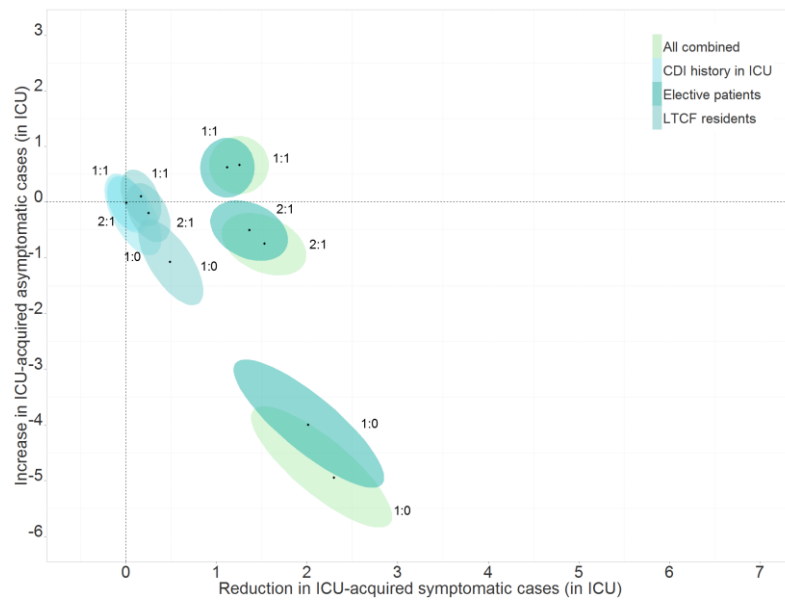

B

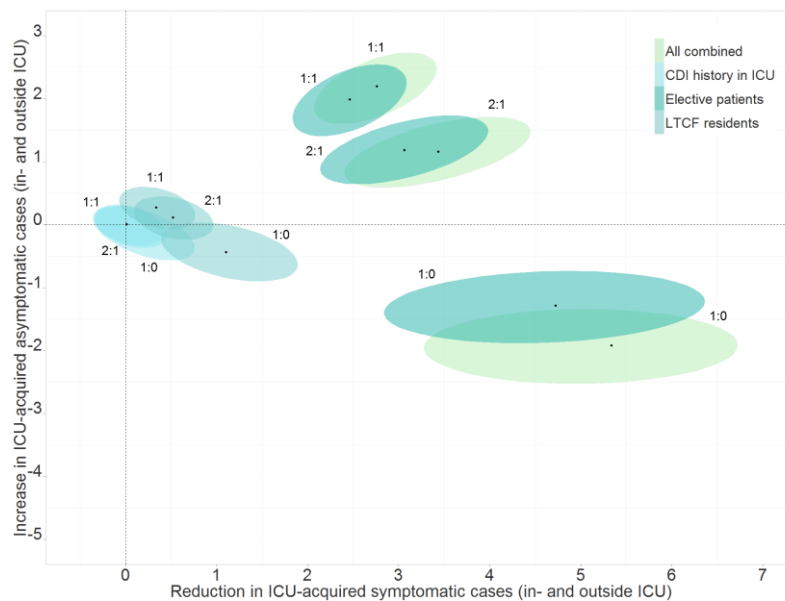

Black points: median absolute reduction in symptomatic cases (x-axis) and increase in symptomatic cases (y-axis) of the 1000 parameter sets. Transparent ellipses plot the 95% coverage intervals. **1:0:** no asymptomatic transmission; **2:1:** asymptomatic carriers are half as transmissible compared to symptomatic carriers; **1:1:** asymptomatic carriers are equally transmissible.

Consequently, the least effective strategies (strategy 1 and 2) required fewer vaccine doses compared to base case scenario to prevent one CDI case (30% fewer in the case of strategy 1 and 29% fewer in the case of strategy 2). This was also true, albeit less pronounced, for strategy 3 and 4, which required 14% and 15% fewer doses respectively. As was shown previously, strategies 1 and 2 prevented primarily imported cases. This was less true for strategies 3 and 4, which saw a higher proportion of acquired ICU-onset CDI prevented than the other two strategies (Table 8). This distinction became less apparent when there was no asymptomatic transmission, i.e. strategy 1 and 2 became relatively more effective in preventing acquired ICU-onset CDI (as was shown by a higher relative increase in the proportion of acquired ICU-onset cases prevented for strategy 1 and 2, Supplementary table 12).

Discussion

This study presented the first dynamic-transmission model-based evaluation of the projected effectiveness of different vaccination strategies on CDI incidence in a high CDI-risk hospital setting. We observed that immunising all three patient groups (LTCF residents, elective patients and patients with a history of ICU-onset CDI) was the most effective strategy studied. With ~17 CDI cases observed annually in our simulated 30-bed ICU (representing current average incidence rates in England[84]), this would equal a prevention of ~seven ICU-onset cases per year. Of the three individual target groups, vaccinating all patients awaiting elective surgery yielded the largest net reduction in ICU-onset cases.

A full cost-effectiveness analysis of any putative CDI vaccine was beyond the scope of this study. However, we did consider efficiency – measured as the number of vaccination doses needed to prevent one case of CDI. We found that vaccinating LTCF residents proved the most efficient in terms of doses per case prevented, primarily as asymptomatic colonisation is frequent among the elderly residents of LTCF[22], and due to the high rates of antimicrobial prescribing in this group compared to the rest of the population[24, 26]. However, it should be noted that the low total number of admissions from LTCF resulted in only a small reduction of the overall risk of colonisation in the ICU. Therefore the proportion of admissions from the LTCF is an important consideration in the generalisability of our findings.

This study is the first to model numerous scenarios to examine the impact of asymptomatic transmission on vaccination. We found that the ranking of each of the strategies, from most to least effective in prevention of CDI for each of the asymptomatic transmission scenarios did not change, the overall impact of vaccination differed markedly. The potential implications of this are further discussed below.

An important finding from this study was the impact of antimicrobial prescribing. In settings with ICU-acquired CDI incidence comparable to the English national average[84]; antimicrobial stewardship can help prevent onset among asymptotically imported cases as well as successfully reduce onward transmission. With lower levels of high risk antimicrobial prescribing, the efficiency of vaccination was greatly reduced and the converse was also true. Therefore, we would suggest that vaccination may be most efficient (and perhaps cost-effective) in settings where antimicrobial stewardship has not been (or can not be) implemented successfully.

Comparison of our findings with previous modelling and molecular studies

Only one previous modelling study by Lee *et al*, has quantified the impact of CDI vaccination in a comparative manner. They found that a CDI vaccine was most likely to be cost-effective when only patients that had experienced a CDI episode[21] were immunised. In our study, vaccinating patients with a history of CDI (in the ICU) had close to no effect on CDI incidence in the ICU, and required ~80 doses to prevent one case. It is likely, however, that our findings differ from those of Lee *et al* due to the differences in the models' underlying assumptions. Lee and colleagues assumed that recurrent CDI would always occur in hospital or result in hospitalisation. In our model, active admission of recurrent cases was not incorporated; primarily as such patients are unlikely to be admitted to the ICU. Moreover, in the absence of vaccination, less than one case per 1000 admissions of the patients with a recurrent ICU-onset CDI was seen, either in the same episode or after re-admissions. This was for two reasons: firstly we observed a low number of relapses during a hospital stay, secondly, the risk of ICU readmission when colonised was low, as the mean colonisation time, as observed by others [19, 20]) equalled the average number of days between ICU-admissions in England as according to HES data (~1 month).

In our study, the balance between ICU-importation and ICU-acquisition of CDI drove the projected effectiveness of vaccination. Previous statistical and molecular studies have questioned the importance of in-hospital transmission from symptomatic patients in the development of CDI in endemic settings[5, 44, 45]. Molecular studies have showed high genetic diversity between symptomatic in hospital cases, and have found a genetic and epidemiological link to another symptomatic source for only a minority of hospital-onset cases (i.e. 19 – 25%)[45, 93, 94]. We showed that, when fitting a highly data-driven model to English national average ICU acquisition rates (allowing for asymptomatic transmission), and using English ICU data-informed colonisation and infection importation rates, the majority (69%) of ICU-onset cases were imported from outside the ICU. These importations concerned primarily patients that were asymptomatic on admission and developed symptoms following exposure to antimicrobials. A recent study also showed that toxigenic *C. difficile* colonisation on ICU admission was an independent risk-factor for developing CDI in the ICU, with the risk of CDI in the ICU mediated by the exposure to antimicrobials[95]. This suggests that, the identification and targeting of patients groups at heightened risk of colonisation, becomes increasingly important when ward-based CDI-onset is not primarily driven by ward-based acquisitions. Vaccinating LTCF residents would be an example of such target populations [58, 59]. Our findings showed that strategy two was the most efficient strategy, regardless of the level of transmission or antimicrobial usage assumed. However, as these patients only formed a fraction of ICU-admission, our findings imply that such targeted approach should be multifaceted, and informed by previous, e.g. [96] and future studies on other risk factors associated with colonisation.

When acquisition risk through ICU-based transmission was high in our model, e.g. as a consequence of high prevalence of BI/NAP1/027[85], the majority of cases were acquired (61%). Not surprisingly, under such conditions, the efficiency of the vaccination strategies was increased markedly, in particular when vaccinating elective patients, which due to the level of induced herd immunity[97], had the greatest population effect. Similarly, Lee et al showed cost-effectiveness of vaccination against first occurrence of CDI is highly sensitive to the risk of acquiring CDI[21].

Strengths

A major strength of our study was that this study has been the first to incorporate data-driven patient movements between the hospital, community and LTCF to simulate the dynamics of *C. difficile* transmission. Hence, heterogeneity in risk factors associated with the infection was allowed for, such as observed higher levels of antimicrobial usage in LTCF populations, than in community populations. Moreover, our individual-based model enabled detailed examination of the complex balance between importation and acquisition of CDI and its interaction with vaccine effectiveness. Extensive analysis of numerous English national datasets and local level data from individual hospitals was conducted to inform key parameters and simulate the English ICU-setting as closely as possible. Great effort was invested in obtaining robust parameter estimates, such as for the excess length of stay and ward-based antimicrobial prescribing. We carefully propagated parameter uncertainty, e.g. second order uncertainty observed in the statistical analysis of antimicrobial usage data was used to inform distributions for the probabilistic sensitivity analysis. Also, natural immunity against *C. difficile* among the critical ill is highly uncertain – limited data from a small study including severely ill patients was used as a proxy [74] – which was incorporated in our model output. This is particularly important, as the degree of natural immunity in the studied population is key in predicting vaccine effectiveness and efficiency (also shown by the sensitivity of our model output to the presumed immunity, data not shown). Finally, we investigated a high number of different scenarios, hence allowing for enhanced generalisability of our findings.

Limitations

This study had several limitations. The calculated number of vaccine doses for strategy 2, 3 and 4 are approximations, and in particular for strategy 2, was likely to be an underestimate, as we did not account for the high mortality rates among LTCF residents and frequent new admissions to the cohort [98]. Secondly, while we considered importations from and infection-onset post ICU discharge, our model only evaluated CDI-dynamics in the ICU. Incorporation of discharge and (re)admission dynamics elsewhere in the hospital may have improved the effectiveness of some strategies (notably vaccinating CDI cases) in preventing healthcare-onset CDI. Also, our model did not incorporate transmission dynamics outside the ICU. Hence, onward transmission prevented from cases with symptom-onset or

recurrence outside the ICU was not captured, resulting in a potential underestimation of vaccine effectiveness in terms of preventing hospital- as well as community-onset CDI. Data to realistically inform such a holistic model is currently limited. Therefore, any such model would have been highly theoretical and its results uncertain. The United States is among the few that has conducted population-based surveillance of CDI on a wider national scale[99, 100]. Similarly, a surveillance programme for hospital-level antimicrobial prescribing data has only recently been implemented in England[101], and while antimicrobial prescribing volume is reported at a general practice level, there is no routine linkage to community CDI surveillance or information at a patient level. Such a model would have also allowed for the investigation of the potential unintended effect of vaccination. We observed that, when asymptomatic carriers contributed to transmission, the number of colonisations outside the ICU increased (though to a lesser extent than the decrease in infections). These asymptomatic cases are more likely to remain unobserved than symptomatic cases, and when transmission-events from such individuals is present, might have unintended consequences for the transmission of *C. difficile* and CDI incidence outside the ICU. When asymptomatic carriers were non-transmissible, this increase in colonisations was not present. Therefore, until we are more certain about the role of asymptomatic patients in the transmission of CDI, it is difficult to define the true effectiveness of vaccination, as well as any infection prevention control strategy.

Conclusions

Through careful modelling of the admission and discharge dynamics between healthcare and community settings, this study has provided useful insight in how and where respective vaccination strategies involving different target groups are most likely to have an impact on CDI incidence rates. Vaccinating LTCF residents and elective patients may aid in preventing CDI in high-risk hospital settings such as the ICU. However in settings with comparable ICU-acquisition and antimicrobial usage rates to England, this would require a high number of vaccine doses, primarily considering the low efficiency of vaccination elective patients. This calls for more careful examination of potential target groups at risk for colonisation on admission and subsequent healthcare-onset CDI. A future hospital and community cost-effectiveness analysis, comparing the effectiveness of our selected vaccination programmes to existing

strategies such as antimicrobial stewardship could aid in determining whether and how a vaccine could be cost-effective.

Conflict of interest statement

None.

Funding sources

EvK was supported by the Healthcare Infection Society Grant: Modelling the population-level effect and cost-effectiveness of *C. difficile* vaccination as part of an integrated healthcare and associated infection prevention and control strategy. MJ was supported by the National Institute for Health Research Health Protection Research Unit (NIHR HPRU) in Immunisation at the London School of Hygiene and Tropical Medicine in partnership with Public Health England (PHE). SD and JR were supported in part by the UK National Institute for Health Research Health Protection Research Unit (NIHR HPRU) in Modelling Methodology at Imperial College London in partnership with Public Health England (PHE) [grant number HPRU-2012-10080]. The views expressed are those of the authors and not necessarily those of the NHS, the NIHR the Department of Health or Public Health England. The funders had no role in study design; in the collection, analysis, and interpretation of data; in the writing of the report; and in the decision to submit the article for publication.

References

1. Van Kleef E, Green N, Goldenberg SD, Robotham JV, Cookson B, Jit M, Edmunds WJ, Deeny SR: **Excess length of stay and mortality due to Clostridium difficile infection: a multi-state modelling approach.** *J Hosp Infect* 2014, **88**:213–217.
2. Riddle D, Dubberke E: **Clostridium difficile Infection in the Intensive Care Unit.** *Infect Dis Clin North Am* 2009, **23**:727–743.
3. Lawrence SJ, Puzniak LA, Shadel BN, Gillespie KN, Kollef MH, Mundy LM: **Clostridium difficile in the Intensive Care Unit : Epidemiology , Costs , and Colonization Pressure.** *Infect Control Hosp Epidemiol* 2007, **28**:123–130.
4. Bobo LD, Dubberke ER, Kollef M: **Clostridium difficile in the ICU: The struggle continues.** *Chest* 2011, **140**:1643–1653.
5. Van Kleef E, Gasparrini A, Guy R, Cookson B, Hope R, Jit M, Robotham J V, Deeny SR, Edmunds WJ: **Nosocomial transmission of C. difficile in English hospitals from patients with symptomatic infection.** *PLoS One* 2014, **9**:e99860.
6. Codella J, Safdar N, Heffernan R, Alagoz O: **An Agent-based Simulation Model for Clostridium difficile Infection Control.** *Med Decis Mak* 2014.
7. Lofgren ET, Moehring RW, Anderson DJ, Weber DJ, Fefferman NH, Hill C, Carolina N: **A Mathematical Model to Evaluate the Routine Use of Fecal Microbiota Transplantation to Prevent Incident and Recurrent Clostridium difficile Infection.** *Infect Control Hosp Epidemiol* 2015, **35**:18–27.
8. Starr JM, Campbell A, Renshaw E, Poxton IR, Gibson GJ: **Spatio-temporal stochastic modelling of Clostridium difficile.** *J Hosp Infect* 2009, **71**:49–56.
9. Starr JM, Campbell A: **Mathematical modeling of Clostridium difficile infection.** *Clin Microbiol Infect* 2001, **7**:432–437.
10. Yakob L, Riley T V, Paterson DL, Marquess J, Clements AC: **Assessing control bundles for Clostridium difficile: a review and mathematical model.** *Emerg Microbes Infect* 2014, **3**:e43.
11. Yakob L, Riley T V, Paterson DL, Clements AC: **Clostridium difficile exposure as an insidious source of infection in healthcare settings: an epidemiological model.** *BMC Infect Dis* 2013, **13**:376.
12. Lanzas C, Dubberke ER, Lu Z, Reske KA, Grohn YT: **Epidemiological model for Clostridium difficile transmission in healthcare settings.** *Infect Control Hosp Epidemiol* 2011, **32**:553–561.
13. Rubin M a, Jones M, Leecaster M, Khader K, Ray W, Huttner A, Huttner B, Toth D, Sablay T, Borotkanics RJ, Gerding DN, Samore MH: **A simulation-based assessment of strategies to control clostridium difficile transmission and infection.** *PLoS One* 2013, **8**:e80671.
14. Lanzas C, Dubberke ER: **Effectiveness of Screening Hospital Admissions to Detect Asymptomatic Carriers of Clostridium difficile: A Modeling Evaluation.** *Infect Control Hosp Epidemiol* 2014, **35**:1043–50.

15. Lanzas C, Dubberke ER: **Effectiveness of Screening Hospital Admissions to Detect Asymptomatic Carriers of Clostridium difficile: A Modeling Evaluation.** *Infect Control Hosp Epidemiol* 2014, **35**:1043–50.
16. Bignardi GE: **Risk factors for Clostridium difficile infection.** *J Hosp Infect* 1998, **40**:1–15.
17. Dubberke ER, Reske KA, Yan Y, Olsen MA, McDonald LC, Fraser VJ: **Clostridium difficile – Associated Disease in a Setting of Endemicity : Identification of Novel Risk Factors.** *Clin Infect Dis* 2007, **2005**:1543–1549.
18. Wiström J, Norrby SR, Myhre EB, Eriksson S, Granström G, Lagergren L, Englund G, Erik C, Svenungsson B: **Frequency of antibiotic-associated diarrhoea in 2462 antibiotic-treated hospitalized patients : a prospective study.** *J Antimicrob Chemother* 2001, **47**:43–50.
19. Abujamel T, Cadnum JL, Jury L a, Sunkesula VCK, Kundrapu S, Jump RL, Stintzi AC, Donskey CJ: **Defining the vulnerable period for re-establishment of Clostridium difficile colonization after treatment of C. difficile infection with oral vancomycin or metronidazole.** *PLoS One* 2013, **8**:e76269.
20. Sethi AK, Al-Nassir WN, Nerandzic MM, Bobulsky GS, Donskey CJ: **Persistence of skin contamination and environmental shedding of Clostridium difficile during and after treatment of C. difficile infection.** *Infect Control Hosp Epidemiol* 2010, **31**:21–7.
21. Lee BY, Popovich MJ, Tian Y, Bailey RR, Ufberg PJ, Wiringa AE, Muder RR: **The potential value of Clostridium difficile vaccine: an economic computer simulation model.** *Vaccine* 2010, **28**:5245–53.
22. Ziakas PD, Zacharioudakis IM, Zervou FN, Grigoras C, Pliakos EE, Mylonakis E: **Asymptomatic Carriers of Toxigenic C. difficile in Long-Term Care Facilities: A Meta-Analysis of Prevalence and Risk Factors.** *PLoS One* 2015, **10**:e0117195.
23. European Centre for Diseases Control: *Surveillance of Antimicrobial Consumption in Europe 2010.* Sweden: European Centre for Disease Prevention and Control; 2013.
24. European Centre for Disease Prevention and Control: *Surveillance of Antimicrobial Consumption in Europe 2011.* Sweden: European Centre for Disease Prevention and Control; 2014.
25. European Centre for Disease Prevention and Control: *Point Prevalence Survey of Healthcare-Associated Infections and Antimicrobial Use in European Long-Term Care Facilities - May - September 2010.* Stockholm; 2010(September).
26. European Centre for Disease Prevention and Control: *Point Prevalence Survey of Healthcare-Associated Infections and Antimicrobial Use in European Long-Term Care Facilities - April - May 2013.* Stockholm: European Centre for Disease Prevention and Control; 2013(May).
27. Van Kleef E, Robotham J V, Jit M, Deeny SR, Edmunds WJ: **Modelling the transmission of healthcare associated infections: a systematic review.** *BMC Infect Dis* 2013, **13**:294.
28. European Centre for Disease Prevention and Control: *Point Prevalence Survey of Healthcare-Associated Infections and Antimicrobial Use in European Acute Care Hospitals.* Stockholm; 2012.
29. **Clostridium difficile infection: annual data**
[https://www.gov.uk/government/statistics/clostridium-difficile-infection-annual-data]

30. Bauer MP, Notermans DW, van Benthem BHB, Brazier JS, Wilcox MH, Rupnik M, Monnet DL, van Dissel JT, Kuijper EJ: **Clostridium difficile infection in Europe: a hospital-based survey.** *Lancet* 2011, **377**:63–73.
31. Evans ME, Simbartl L a., Kralovic SM, Jain R, Roselle G a.: **Clostridium difficile Infections in Veterans Health Administration Acute Care Facilities.** *Infect Control Hosp Epidemiol* 2014, **35**:1037–1042.
32. Mears a, White a, Cookson B, Devine M, Sedgwick J, Phillips E, Jenkinson H, Bardsley M: **Healthcare-associated infection in acute hospitals: which interventions are effective?** *J Hosp Infect* 2009, **71**:307–13.
33. Cohen SH, Gerding DN, Johnson S, Kelly CP, Loo VG, McDonald LC, Pepin J, Wilcox MH: **Clinical practice guidelines for Clostridium difficile infection in adults: 2010 update by the society for healthcare epidemiology of America (SHEA) and the infectious diseases society of America (IDSA).** *Infect Control Hosp Epidemiol* 2010, **31**:431–55.
34. Greenberg RN, Marbury TC, Foglia G, Warny M: **Phase I dose finding studies of an adjuvanted Clostridium difficile toxoid vaccine.** *Vaccine* 2012, **30**:2245–9.
35. **Sanofi Pasteur Initiates Phase III Study of Investigational Clostridium difficile Vaccine in the United States** [<http://www.multivu.com/mnr/62652-sanofi-pasteur-initiates-phase-iii-study-of-investigational-vaccine>]
36. **Study of Different Formulations of a Clostridium Difficile Toxoid Vaccine Given at Three Different Schedules in Adults** [<http://clinicaltrials.gov/ct2/show/NCT01230957>]
37. Donald RGK, Flint M, Kalyan N, Johnson E, Witko SE, Kotash C, Zhao P, Megati S, Yurgelonis I, Lee PK, Matsuka Y V, Severina E, Deatly A, Sidhu M, Jansen KU, Minton NP, Anderson AS: **A novel approach to generate a recombinant toxoid vaccine against Clostridium difficile.** *Microbiology* 2013, **159**(Pt 7):1254–66.
38. Foglia G, Shah S, Luxemburger C, Freda PJ: **Clostridium difficile : Development of a novel candidate vaccine.** *Vaccine* 2012, **30**:4307–4309.
39. **Sanofi Pasteur Investigational Vaccine against Clostridium difficile Fact Sheet** [<http://www.multivu.com/assets/62652/documents/62652-SP-C-diff-Vaccine-Fact-Sheet-FINAL-8-2-13-original.pdf>]
40. Ward SJ, Douce G, Figueiredo D, Dougan G, Wren BW, Al WET, Mmun INI: **Vaccine Expressing a Nontoxic Domain of Clostridium difficile Toxin A.** *Society* 1999, **67**:2145–2152.
41. Ward SJ, Douce G, Dougan G, Wren BW: **Local and systemic neutralizing antibody responses induced by intranasal immunization with the nontoxic binding domain of toxin A from Clostridium difficile.** *Infect Immun* 1999, **67**:5124–32.
42. Torres JF, Lyerly DM, Hill JE: **Evaluation of formalin-inactivated Clostridium difficile vaccines administered by parenteral and mucosal routes of immunization in hamsters . Evaluation of Formalin-Inactivated Clostridium difficile Vaccines Administered by Parenteral and Mucosal Routes o.** *Microbiology* 1995.
43. Kotloff KL, Wasserman SS, Genevieve A, Jr WT, Nichols R, Bridwell M, Monath TP, Losonsky GA, Thomas W, Edelman R: **Safety and Immunogenicity of Increasing Doses of a Clostridium difficile Toxoid Vaccine Administered to Healthy Adults Safety and Immunogenicity of Increasing**

Doses of a Clostridium difficile Toxoid Vaccine Administered to Healthy Adults. *Infect immunity* 2001.

44. Walker A, Eyre D, Wyllie D, Dingle K, Harding R, O'Connor L, Griffiths D, Vaughan A, Finney J, Wilcox M, Crook D, Peto T: **Characterisation of Clostridium difficile Hospital Ward-Based Transmission Using Extensive Epidemiological Data and Molecular Typing.** *PLoS Med* 2012, **9**:e1001172.
45. Eyre DW, Cule ML, Wilson DJ, Griffiths D, Vaughan A, O'Connor L, Ip CLC, Golubchik T, Batty EM, Finney JM, Wyllie DH, Didelot X, Piazza P, Bowden R, Dingle KE, Harding RM, Crook DW, Wilcox MH, Peto TE a., Walker a. S: **Diverse Sources of C. difficile Infection Identified on Whole-Genome Sequencing.** *N Engl J Med* 2013, **369**:1195–1205.
46. Curry SR, Muto C a, Schlackman JL, Pasculle a W, Shutt K a, Marsh JW, Harrison LH: **Use of multilocus variable number of tandem repeats analysis genotyping to determine the role of asymptomatic carriers in Clostridium difficile transmission.** *Clin Infect Dis* 2013, **57**:1094–102.
47. McFarland LV, Mulligan ME, Kwok RYY, Stam WE: **Nosocomial acquisition of Clostridium difficile infection.** *N Engl J Med* 1989, **321**:190.
48. Samore MH, Venkataraman L, Degirolami PC, Arbeit RD, Karchmer AW: **Clinical and Molecular Epidemiology of Sporadic and Clustered Cases of Nosocomial Clostridium difficile Diarrhea.** *Am J Med* 1996, **100**(January):32–40.
49. Kaatz G, Gitlin S, Schaberg D, Wilson KH, Kauffman CA, Seo SM, Fekety R: **Acquisition of clostridium difficile from the hospital environment.** *Am J Epidemiol* 1988, **127**:1289–1294.
50. Dubberke ER, Olsen MA: **Burden of Clostridium difficile on the healthcare system.** *Clin Infect Dis* 2012, **55 Suppl 2**:S88–92.
51. McGlone SM, Bailey RR, Zimmer SM, Popovich MJ, Tian Y, Ufberg P, Muder RR, Lee BY: **The economic burden of Clostridium difficile.** *Clin Microbiol Infect* 2012, **18**:282–9.
52. Ghantaji SS, Sail K, Lairson DR, DuPont HL, Garey KW: **Economic healthcare costs of Clostridium difficile infection: a systematic review.** *J Hosp Infect* 2010, **74**:309–318.
53. Dubberke ER, Yan Y, Reske K a, Butler AM, Doherty J, Pham V, Fraser VJ: **Development and validation of a Clostridium difficile infection risk prediction model.** *Infect Control Hosp Epidemiol* 2011, **32**:360–6.
54. Hensgens MPM, Goorhuis A, van Kinschot CMJ, Crobach MJT, Harmanus C, Kuijper EJ: **Clostridium difficile infection in an endemic setting in the Netherlands.** *Eur J Clin Microbiol Infect Dis* 2011, **30**:587–93.
55. Markwart R, Condotta S a., Requardt RP, Borken F, Schubert K, Weigel C, Bauer M, Griffith TS, Förster M, Brunkhorst FM, Badovinac VP, Rubio I: **Immunosuppression after Sepsis: Systemic Inflammation and Sepsis Induce a Loss of Naïve T-Cells but No Enduring Cell-Autonomous Defects in T-Cell Function.** *PLoS One* 2014, **9**:e115094.
56. Public Health England (former Health Protection Agency): *English National Point Prevalence Survey on Healthcare-Associated Infections and Antimicrobial Use , 2011 - Appendices.* 2011.
57. Brett S: **Science review: The use of proton pump inhibitors for gastric acid suppression in critical illness.** *Crit care* 2005, **9**:45–50.

58. Ricciardi R, Nelson J, Griffith JL, Concannon TW: **Do admissions and discharges to long-term care facilities influence hospital burden of Clostridium difficile infection?** *J Hosp Infect* 2012, **80**:156–61.
59. Vesteyndottir I, Gudlaugsdottir S, Einarsdottir R, Kalaitzakis E, Sigurdardottir O, Bjornsson ES: **Risk factors for clostridium difficile toxin-positive diarrhea: A population-based prospective case-control study.** *Eur J Clin Microbiol Infect Dis* 2012, **31**:2601–2610.
60. Eyre DW, Walker a S, Wyllie D, Dingle KE, Griffiths D, Finney J, O'Connor L, Vaughan A, Crook DW, Wilcox MH, Peto TE a: **Predictors of first recurrence of Clostridium difficile infection: implications for initial management.** *Clin Infect Dis* 2012, **55 Suppl 2**(Suppl 2):S77–87.
61. Wilcox M., Fawley WN, Settle CD, Davidson A: **Recurrence of symptoms in Clostridium difficile infection - relapse or reinfection?** *Hosp Infect Soc* 1998, **38**:93–100.
62. Garey KW, Sethi S, Yadav Y, DuPont HL: **Meta-analysis to assess risk factors for recurrent Clostridium difficile infection.** *J Hosp Infect* 2008, **70**:298–304.
63. Kim S-Y, Goldie SJ: **Cost-effectiveness analyses of vaccination programmes : a focused review of modelling approaches.** *Pharmacoeconomics* 2008, **26**:191–215.
64. Anderson R., May R.: *Infectious Diseases of Humans, Dynamics and Control.* Oxford and New York: Oxford University Press; 1991.
65. Anderson RM, May RM: *Infectious Diseases of Humans.* Oxford University Press; 1991.
66. Jit M, Brisson M: **Modelling the Epidemiology of Infectious Diseases for Decision Analysis A Primer.** 2011, **29**:371–386.
67. Fraise AP, Bradley C: *Ayliffe's Control of Healthcare-Associated Infection: A Practical Handbook.* Hodder Arnold; 2009.
68. Owens RC, Donskey CJ, Gaynes RP, Loo VG, Muto C a: **Antimicrobial-associated risk factors for Clostridium difficile infection.** *Clin Infect Dis* 2008, **46 Suppl 1**(Suppl 1):S19–31.
69. Thomas C, Stevenson M, Riley T V: **Antibiotics and hospital-acquired Clostridium difficile-associated diarrhoea: a systematic review.** *J Antimicrob Chemother* 2003, **51**:1339–1350.
70. Teasley DG, Olson MM, Gebhard RL, Gerding DN, Peterson LR, Schwartz MJ, Lee JT: **Prospective randomised trial of metronidazole versus vancomycin for clostridium-difficile-associated diarrhoea and colitis.** *Lancet* 1983, **322**:1043–1046.
71. Clabots CR, Johnson S, Olson MM, Peterson LR, Gerding DN: **Acquisition of Clostridium difficile by hospitalized patients: evidence for colonized new admissions as a source of infection.** *J Infect Dis* 1992, **166**:561–7.
72. Deeny SR, Cooper BS, Cookson B, Hopkins S, Robotham J V: **Targeted versus universal screening and decolonization to reduce healthcare-associated meticillin-resistant Staphylococcus aureus infection.** *J Hosp Infect* 2013, **85**:33–44.
73. Public Health England (former Health Protection Agency): *English National Point Prevalence Survey on Healthcare-Associated Infections and Antimicrobial Use, 2011 - Preliminary Data.* London; 2012.

74. Kyne L, Warny M, Qamar a, Kelly CP: **Asymptomatic carriage of Clostridium difficile and serum levels of IgG antibody against toxin A.** *N Engl J Med* 2000, **342**:390–397.
75. Fuller C, Robotham J, Savage J, Deeny S, Hopkins S, Cookson B, Stone S: **The National One Week Prevalence Audit of MRSA Screening.** Dept. of Health Report. 2013(March).
76. Van Kleef E, Green N, Goldenberg SD, Robotham JV, Cookson B, Jit M, Edmunds WJ, Deeny SR: **Excess length of stay and mortality due to Clostridium difficile infection: a multi-state modelling approach.** *J Hosp Infect* 2014.
77. Dodek PM, Norena M, Ayas NT, Romney M, Wong H: **Length of stay and mortality due to Clostridium difficile infection acquired in the intensive care unit.** *J Crit Care* 2013, **28**:335–40.
78. **National Statistics Hospital Episode Statistics, Admitted Patient Care, England - 2013-14 [NS]** [<http://www.hscic.gov.uk/catalogue/PUB16719>]
79. **Adult Critical Care Data in England - April 2013 to March 2014** [<http://www.hscic.gov.uk/searchcatalogue?q=title:“Adult+Critical+Care+data+in+England”&size=10&sort=Relevance>]
80. Kyne L, Warny M, Qamar A, Kelly CP: **Early report Association between antibody response to toxin A and protection against recurrent Clostridium difficile diarrhoea.** *Lancet* 2001, **357**:189–93.
81. Kyne L, Warny M, Qamar A, Ciaran P: **Asymptomatic carriage of clostridium difficile and serum levels of IgG antibody against toxin A.** *N Engl J Med* 2000, **10**:390–397.
82. Siddiqui F, O'Connor JR, Nagaro K, Cheknis A, Sambol SP, Vedantam G, Gerding DN, Johnson S: **Vaccination with parenteral toxoid B protects hamsters against lethal challenge with toxin A-negative, toxin B-positive clostridium difficile but does not prevent colonization.** *J Infect Dis* 2012, **205**:128–133.
83. Eyre DW, Griffiths D, Vaughan A, Golubchik T, Acharya M, O'Connor L, Crook DW, Walker a S, Peto TE a: **Asymptomatic Clostridium difficile colonisation and onward transmission.** *PLoS One* 2013, **8**:e78445.
84. ICNARC: *Key Statistics from the Case Mix Programme. Volume 2.* London, England; 2014(March 2013).
85. Didelot X, Eyre DW, Cule M, Ip CL, Ansari MA, Griffiths D, Vaughan A, O'Connor L, Golubchik T, Batty EM, Piazza P, Wilson DJ, Bowden R, Donnelly PJ, Dingle KE, Wilcox M, Walker a S, Crook DW, A Peto TE, Harding RM: **Microevolutionary analysis of Clostridium difficile genomes to investigate transmission.** *Genome Biol* 2012, **13**:R118.
86. Health Protection Agency: *Clostridium Difficile Ribotyping Network (CDRN) for England and Northern Ireland.* 2014.
87. McKay M, Beckman R, Conover W: **A Comparison of Three Methods for Selecting Values of Input Variables in the Analysis of Output from a Computer Code.** *Technometrics* 1979, **21**:239–245.
88. Harrison D a, Brady AR, Rowan K: **Case mix, outcome and length of stay for admissions to adult, general critical care units in England, Wales and Northern Ireland: the Intensive Care National Audit & Research Centre Case Mix Programme Database.** *Crit Care* 2004, **8**:R99–R111.

89. Barnett AG, Batra R, Graves N, Edgeworth J, Robotham J, Cooper B: **Using a longitudinal model to estimate the effect of methicillin-resistant *Staphylococcus aureus* infection on length of stay in an intensive care unit.** *Am J Epidemiol* 2009, **170**:1186–94.
90. Zahar J-R, Schwebel C, Adrie C, Garrouste-Orgeas M, Français A, Vesin A, Nguile-Makao M, Tabah A, Laupland K, Le-Monnier A, Timsit J-F: **Outcome of ICU patients with *Clostridium difficile* infection.** *Crit Care* 2012, **16**:R215.
91. Biswas J, Karen, Bisnauthsing Amita P, Christopher, Ward Duncan W, van Kleef E, Goldenberg S: **C. difficile reservoirs and potential risk of transmission in three patient groups: asymptotically colonised, C. difficile excretors and infected patients.** In *ECCMID 2014 conference abstract*. Basel: ESCMID; 2014.
92. **How to get and re-use CQC information and data** [<http://www.cqc.org.uk/content/how-get-and-re-use-cqc-information-and-data#directory>]
93. Walker a S, Eyre DW, Wyllie DH, Dingle KE, Harding RM, O'Connor L, Griffiths D, Vaughan A, Finney J, Wilcox MH, Crook DW, Peto TE a: **Characterisation of *Clostridium difficile* hospital ward-based transmission using extensive epidemiological data and molecular typing.** *PLoS Med* 2012, **9**:e1001172.
94. Didelot X, Eyre D, Cule M, Ip C, Ansari A, Griffiths D, Vaughan A, O'Connor L, Golubchik T, Batty E, Piazza P, Wilson D, Bowden R, Donnelly P, Dingle K, Wilcox M, Walker S, Crook D, Peto T, Harding R: **Microevolutionary analysis of *Clostridium difficile* genomes to investigate transmission.** *Genome Biol* 2012, **13**:R118.
95. Tschudin-Sutter S, Carroll KC, Tamma PD, Sudekum ML, Frei R, Widmer AF, Ellis BC, Bartlett J, Perl TM: **Impact of Toxigenic *Clostridium difficile* Colonization on the Risk of Subsequent C. difficile Infection in Intensive Care Unit Patients.** *Infect Control Hosp Epidemiol* 2015:1–6.
96. Leekha S, Aronhalt KC, Sloan LM, Patel R, Orenstein R: **Asymptomatic *Clostridium difficile* colonization in a tertiary care hospital: admission prevalence and risk factors.** *Am J Infect Control* 2013, **41**:390–3.
97. Edmunds WJ, Medley GF, Nokes DJ: **Evaluating the cost-effectiveness of vaccination programmes: a dynamic perspective.** *Stat Med* 1999, **18**:3263–82.
98. Forder A: **A brief history of infection control - past and present.** *South African Med J* 2007, **97**:1161–1164.
99. **Technical Information - *Clostridium difficile* Tracking** [http://www.cdc.gov/hai/eip/cdiff_techinfo.html]
100. Lessa F, Yi Mu M, Bamberg W, Beldavs Z, Dumyati G, Dunn J, Farley M, Holzbauer S, Meek J, Phipps EC, Wilson LE, Winston LG, Cohen JA, Limbago BM, Ph D, Fridkin SK, Gerding DN, McDonald LC: **Burden of *Clostridium difficile* Infection in the United States.** *N Engl J Med* 2015, **372**:825–34.
101. Public Health England: *English Surveillance Programme for Antimicrobial Utilisation and Resistance (ESPAUR) Report 2014 About Public Health England*. London; 2014.
102. Dunnigan K: **Confidence Interval Calculation for Binomial Proportions.** 2008.

Supplementary material

Supplementary table 3: Values used in scenario analysis

Scenario	β_1	β_2	α_{icu}	α_{gm}	ϵ
Scenario 1 (AT+AA+VE=100%)	0.0074	0.0037	0.219	0.081	1
Scenario 2 (HT+AA+VE=100%)	0.0196	0.0098	0.219	0.081	1
Scenario 3 (AT+LA+VE=100%)	0.0074	0.0037	0.149	0.052	1
Scenario 4 (HT+LA+VE=100%)	0.0196	0.0098	0.149	0.052	1
Scenario 5 (AT+AA+VE=70%)	0.0074	0.0037	0.219	0.081	0.7
Scenario 6 (AT+AA+VE=50%)	0.0074	0.0037	0.219	0.081	0.5
Asymptomatic 1:0 (and AT+AA+VE=100%)	0.0169	0.0533	0.219	0.081	1
Asymptomatic 1:1 (and AT+AA+VE=100%)	0.0047	0.0126	0.219	0.081	1

Supplementary table 4: Values used in probabilistic sensitivity analysis

Parameter	Description	Distribution LHS
α_{icu}	Fraction of patients on antimicrobials in the ICU on a given day	Logitnormal(-1.274; SD 0.08)
α_{gm}	Fraction of patients admitted from GM on antimicrobials on admission to the ICU	Logitnormal(-2.431; SD 0.06)
α_{ltcf}	Fraction of patients directly admitted from LTCF on antimicrobials on admission	Beta(0.040; SD 0.006)
α_{com}	Fraction of patients directly admitted from the community on antimicrobials on admission	Beta(0.012; SD 0.004)
$f_{ltcf} = f_{com}$	Fraction of patients admitted to ICU from the LTCF/ community that develop a natural immune response against disease	Beta(0.240; SD 0.077)
a_{i_ltcf}	Fraction of patients from LTCF that were infected on admission to ICU	Posterior distribution (see methods)
a_{c_ltcf}	Fraction of patients from LTCF that were colonised on admission to ICU	Posterior distribution (see methods)

Supplementary table 5: Daily probability of discharge and death in the ICU ward for CDI- and CDI+ patients

Time (days)	Daily ICU discharge probability CDI-	Daily ICU discharge probability CDI+ (↓28%)	Daily ICU death probability CDI-/CDI+
0	0.00000	0.00000	0.00000
1	0.08547	0.06154	0.02610
2	0.16822	0.12112	0.04064
3	0.23596	0.16989	0.02714
4	0.17647	0.12706	0.02583
5	0.16071	0.11571	0.02491
6	0.12766	0.09191	0.02668
7	0.07317	0.05268	0.01765
8	0.07895	0.05684	0.01885
9	0.14286	0.10286	0.01893
10	0.20000	0.14400	0.02631
11	0.04167	0.03000	0.01367
12	0.04348	0.03130	0.01637
13	0.18182	0.13091	0.02334
14	0.05556	0.04000	0.02143
15	-	-	0.02229
16	-	-	0.01598
17	-	-	0.01847
18	-	-	0.01474
19	-	-	0.01289
20	-	-	0.01387
21	-	-	0.02734
22	-	-	0.01204

Supplementary table 6: Model estimates of the mixed-effect logistic regression model

Ward specialty	x_w	$\sqrt{\sigma^2}$	$\sqrt{\sigma^2_{\text{trust}}}$	$\alpha_w = 1/(1 + \exp(-x_w))$	25 th percentile (incorporating $\sqrt{\sigma^2_{\text{trust}}}$)
<i>ICU</i>	-1.274	0.08	0.401	0.219	0.149
<i>General medicine</i>	-2.431	0.06	0.403	0.081	0.052

Supplementary table 7: Antimicrobial use in the community and LTCF

	Community		LTCF	
	DDD/100		N (per 100 residents)	
	2010	2011	2010	2013
Number of eligible individuals included in sample	59,255,000	63,232,700	7,498	3,954
J01C BETA-LACTAM ANTIBACTERIALS, PENICILLINS	0.856	0.872	166 (2.21)	109 (2.76)
J01D OTHER BETA-LACTAM ANTIBACTERIALS	0.055	0.042	62 (0.83)	29 (0.73)
J01F MACROLIDES, LINCOSAMIDES AND STREPTOGRAMINS	0.273	0.281	29 (0.39)	27 (0.68)
J01M QUINOLONE ANTIBACTERIALS	0.046	0.043	24 (0.32)	9 (0.23)
Total	1.230	1.238	281 (3.75)	174 (4.40)

Supplementary table 8: Importation rates of infected and colonised individuals

Status	Cases	Total screened	Total admissions	Proportion	Lower#	Upper#
Carrier ICU	20	744	1332	0.027	0.017	0.041
Infected ICU	4	744	1332	0.003	0.001	0.008
Carrier ICU AND LTCF	0	30	53	0	0	0.114
Infected ICU AND LTCF	0	30	53	0	0	0.114
Carrier ICU and Community	20	714*	1279*	0.028	0.018	0.043
Infected ICU and community	4	714*	1279*	0.003	0.001	0.008

* Under the assumption that four per cent of the total admissions are patients from LTCFs; # 95% confidence intervals calculated using the Wilson score method[102]

Supplementary table 9: Model outcome per 1000 admissions for each of the different vaccination strategies and scenarios under average transmission assumptions

Average transmission levels + Average antimicrobial use + VE = 100% + Asymptomatic transmission 2:1 (Base case scenario)					
Outcome	Number of cases per 1000 admissions (Median [IQR]) Strategy: 0	Difference (Median [IQR]) Strategy: 1	Difference (Median [IQR]) Strategy: 2	Difference (Median [IQR]) Strategy: 3	Difference (Median [IQR]) Strategy: 4
Total ICU acquisitions infections + colonisations	13.9 [13.1 – 14.9]	↓0.1 [-0.2 – 0.4]	↓0.4 [0.1 – 0.8]	↓1.9 [1.5 – 2.3]	↓2.2 [1.9 – 2.8]
<i>New colonisations</i>	6.2 [5.8 – 6.8]	0 [-0.1 – 0.2]	↑0.1 [-0.1 – 0.3]	↑1.2 [0.9 – 1.5]	↑1.2 [0.9 – 1.4]
<i>New infections</i>	7.7 [6.8 – 8.6]	0 [-0.1 – 0.2]	↓0.5 [0.3 – 0.7]	↓3.1 [2.7 – 3.5]	↓3.4 [3.0 – 3.9]
ICU-onset	3.3 [2.9 – 3.7]	0 [-0.1 – 0.1]	↓0.3 [0.1 – 0.4]	↓1.4 [1.2 – 1.6]	↓1.5 [1.3 – 1.8]
No ICU-onset	4.4 [3.9 – 4.9]	0 [-0.1 – 0.1]	↓0.3 [0.2 – 0.4]	↓1.7 [1.5 – 1.9]	↓1.9 [1.6 – 2.2]
Total imported infections	7.5 [7.1 – 8.1]				
<i>Community-acquired</i>	7.0 [6.6 – 7.5]	0 [-0.1 – 0.1]	↓0.7 [0.5 – 0.8]	↓2.2 [2.0 – 2.4]	↓2.8 [2.6 – 3.0]
<i>Readmission of previously colonised/ infected case</i>	0.5 [0.5 – 0.6]	↓0.1 [0.1 – 0.2]	↓0.1 [0.0 – 0.1]	↓0.3 [0.3 – 0.4]	↓0.4 [0.4 – 0.4]
Total imported colonisations	20.8 [20.3 – 21.4]				
<i>Community-acquired</i>	18.6 [18.1 – 19.1]	0 [-0.1 – 0.1]	↑0.6 [0.4 – 0.8]	↑1.8 [1.6 – 2.0]	↑2.3 [2.0 – 2.3]
<i>Readmission of previously colonised/ infected case</i>	2.2 [2.1 – 2.3]	↓0.1 [0.1 – 0.2]	0 [-0.1 – 0.1]	↑0.1 [-0.1 – 0.1]	0 [0 – 0.1]
<i>Relapse/ recurrence on readmission</i>	0.1 [0.1 – 0.1]	↓0.1 [0.1 – 0.1]	0 [0 – 0]	↓0.1 [0.1 – 0.1]	↓0.1 [0.1 – 0.1]

Model output in the base case scenario (assuming average transmission levels, asymptomatic carriers have half the transmission potential compared to symptomatic carriers (2:1), and average levels of antimicrobial prescribing); **Red arrows:** increase compared to a strategy 0 (no vaccination); **black arrows:** decrease compared to strategy 0

Supplementary table 10: Model outcome per 1000 admissions for each of the different vaccination strategies and scenarios under high transmission assumptions

High transmission levels + Average antimicrobial use + VE = 100% + Asymptomatic transmission 2:1 (scenario 2)					
Outcome	Number of cases per 1000 admissions (Median [IQR]) Strategy: 0	Difference (Median [IQR]) Strategy: 1	Difference (Median [IQR]) Strategy: 2	Difference (Median [IQR]) Strategy: 3	Difference (Median [IQR]) Strategy: 4
Total ICU acquisitions infections + colonisations	55.6 [52.0 – 59.7]	↓0.4 [-0.4 – 1.2]	↓1.3 [0.6 – 2.1]	↓7.0 [6.0 – 7.7]	↓8.3 [7.2 – 9.5]
<i>New colonisations</i>	25.1 [22.8 – 27.2]	↓0.1 [-0.5 – 0.2]	↑0.6 [0.2 – 1.0]	↑4.9 [4.0 – 6.0]	↑5.0 [4.1 – 6.1]
<i>New infections</i>	30.6 [27.0 – 34.2]	↓0.3 [-0.2 – 0.7]	↓1.9 [1.4 – 2.4]	↓12.0 [10.4 – 13.5]	↓13.3 [11.7 – 15.0]
ICU-onset	12.6 [11.2 – 14.0]	↓0.2 [-0.1 – 0.4]	↓0.8 [0.6 – 1.1]	↓5.1 [4.4 – 5.7]	↓5.7 [5.0 – 6.5]
No ICU-onset	18.0 [15.9 – 20.2]	↓0.1 [-0.1 – 0.4]	↓1.1 [0.7 – 1.4]	↓6.8 [6.0 – 7.7]	↓7.6 [6.7 – 8.6]
Total imported infections	8.3 [7.6 – 8.8]				
<i>Community-acquired</i>	7.0 [6.5 – 7.4]	0 [-0.1 – 0.1]	↓0.7 [0.5 – 0.8]	↓2.2 [2.0 – 2.3]	↓2.8 [2.6 – 3.0]
<i>Readmission of Previously colonised/ infected case</i>	1.3 [1.1 – 1.4]	↓0.1 [0.1 – 0.2]	↓0.1 [0.1 – 0.2]	↓0.7 [0.5 – 0.8]	↓0.9 [0.8 – 1.0]
Total imported colonisations	23.0 [22.3 – 23.7]				
<i>Community-acquired</i>	18.5 [18.0 – 19.0]	0 [-0.2 – 0.2]	↑0.6 [0.4 – 0.8]	↑1.8 [1.6 – 2.0]	↑2.3 [2.0 – 2.6]
<i>Readmission of Previously colonised/ infected case</i>	4.5 [4.3 – 4.7]	↑0.3 [0.2 – 0.4]	0 [-0.1 – 0.1]	↓0.3 [0.2 – 0.4]	↓0.3 [0.2 – 0.4]
<i>Relapse/ recurrence on readmission</i>	0.3 [0.3 – 0.4]	↓0.3 [0.3 – 0.4]	0 [0 – 0.1]	↓0.1 [0.1 – 0.3]	↓0.3 [0.3 – 0.4]

Model output in scenario 2; **Red arrows:** increase compared to a strategy 0 (no vaccination); **black arrows:** decrease compared to strategy 0.

Supplementary table 11: Model outcome per 1000 admissions for each of the different vaccination strategies and scenarios under low antimicrobial use assumptions

Average transmission + Low antimicrobial use + VE = 100% + Asymptomatic transmission 2:1 (scenario 3)				
Outcome	Number of cases per 1000 admissions (Median [IQR]) Strategy: 0	Difference (Median [IQR]) Strategy: 2	Difference (Median [IQR]) Strategy: 3	Difference (Median [IQR]) Strategy: 4
Total ICU acquisitions infections + colonisations	8.5 [8.1 – 8.8]	↓0.2 [0 – 0.4]	↓0.9 [0.7 – 1.1]	↓1.1 [0.9 – 1.3]
<i>New colonisations</i>	3.8 [3.5 – 4.1]	↓0.1 [0 – 0.2]	↑0.9 [0.7 – 1.0]	↑0.9 [0.7 – 1.1]
<i>New infections</i>	4.7 [4.2 – 5.1]	↓0.3 [0.2 – 0.4]	↓1.8 [1.6 – 2.0]	↓2.0 [1.8 – 2.2]
ICU-onset	2.0 [1.8 – 2.2]	↓0.1 [0.1 – 0.2]	↓0.8 [0.7 – 0.9]	↓0.9 [0.8 – 1.0]
No ICU-onset	2.6 [2.4 – 2.9]	↓0.2 [0.1 – 0.2]	↓1.0 [0.8 – 1.1]	↓1.1 [1.0 – 1.2]
Total imported infections	6.3 [5.9 – 6.6]			
<i>Community-acquired</i>	5.9 [5.5 – 6.2]	↓0.6 [0.4 – 0.7]	↓1.8 [1.7 – 2.0]	↓2.3 [2.2 – 2.5]
<i>Readmission of Previously colonised/ infected case</i>	0.4 [0.3 – 0.4]	0 [0 – 0.1]	↓0.1 [0.1 – 0.3]	↓0.3 [0.1 – 0.3]
Total imported colonisations	21.4 [21.0 – 21.9]			
<i>Community-acquired</i>	19.5 [19.1 – 19.9]	↑0.5 [0.3 – 0.7]	↑1.5 [1.3 – 1.7]	↑1.9 [1.7 – 2.1]
<i>Readmission of previously colonised/ infected case</i>	1.9 [1.9 – 2.0]	0 [0 – 0.1]	0 [-0.1 – 0.1]	0 [0 – 0.1]
<i>Relapse/ recurrence on readmission</i>	0 [0 – 0]	0 [0 – 0]	0 [0 – 0]	0 [0 – 0]

Model output in scenario 3; **Red arrows**: increase compared to a strategy 0 (no vaccination); **black arrows**: decrease compared to strategy 0.

Supplementary table 12: Scenario analysis for asymptomatic transmission

	Average transmission			High transmission		
	ICU-onset CDI cases prevented/1000 admissions	Proportion of the ICU-onset cases prevented that were acquired	Doses required to avert one ICU-onset CDI case (scaled to ICU)	ICU-onset CDI cases prevented/1000 admissions	Proportion of the ICU-onset cases prevented that were acquired	Doses required to avert one ICU-onset CDI case (scaled to ICU)
Symptomatic: Asymptomatic (2:1) Scenario 1 (AA + VE = 100%)						
1) History of CDI in ICU	0.1 [0 – 0.3]	0.20	83 [33 – NA]	0.5 [0.2 – 0.8]	0.34	43 [27 – 115]
2) LTCF residents	1.0 [0.8 – 1.2]	0.24	14 [11 – 17]	1.6 [1.3 – 2.0]	0.50	8 [7 – 10]
3) Elective patients	3.9 [3.5 – 4.2]	0.36	146 [133 – 162]	7.9 [7.1 – 8.8]	0.64	72 [65 – 80]
4) All combined	4.7 [4.3 – 5.1]	0.34	124 [113 – 137]	9.4 [8.4 – 10.4]	0.61	63 [57 – 70]
Symptomatic: Asymptomatic (1:0) Scenario 1 (AA + VE = 100%)						
1) History of CDI in ICU	0.2 [0 – 0.4]	0.37	58 [15 – NA]	-	-	-
2) LTCF residents	1.3 [1.0 – 1.6]	0.38	10 [8 – 13]	2.5 [2.0 – 3.1]	0.64	5 [4 – 7]
3) Elective patients	4.5 [4.0 – 5.2]	0.45	125 [110 – 141]	10.7 [9.2 – 12.6]	0.72	53 [45 – 62]
4) All combined	5.5 [4.8 – 6.2]	0.42	105 [93 – 121]	12.6 [10.6 – 14.7]	0.70	47 [40 – 45]
Symptomatic: Asymptomatic (1:1) Scenario 1 (AA + VE = 100%)						
1) History of CDI in ICU	0.1 [0 – 0.3]	0.04	89 [37 – NA]	-	-	-
2) LTCF residents	0.9 [0.7 – 1.1]	0.18	15 [12 – 19]	1.4 [1.1 – 1.8]	0.45	9 [8 – 12]
3) Elective patients	3.6 [3.3 – 3.9]	0.31	157 [146 – 172]	7.1 [6.4 – 7.7]	0.61	80 [73 – 88]
4) All combined	4.4 [4.0 – 4.8]	0.28	132 [123 – 144]	8.5 [7.7 – 9.3]	0.58	70 [64 – 77]

Supplementary table 13: Model outcome per 1000 admissions for each of the different vaccination strategies and scenarios for asymptomatic transmission

Outcome	Average transmission + Average Antimicrobial use + 100% VE + asymptomatic 1:0					Average transmission + Average Antimicrobial use + 100% VE + asymptomatic 1:1			
	Number of cases (Median [IQR]) Strategy: 0	Difference (Median [IQR]) Strategy: 1	Difference (Median [IQR]) Strategy: 2	Difference (Median [IQR]) Strategy: 3	Difference (Median [IQR]) Strategy: 4	Difference (Median [IQR]) Strategy: 1	Difference (Median [IQR]) Strategy: 2	Difference (Median [IQR]) Strategy: 3	Difference (Median [IQR]) Strategy: 4
Total ICU acquisitions infections + colonisations	13.9 [13.1 – 14.9]	↓0.3 [0.2 – 0.8]	↓1.6 [1.1 – 2.1]	↓6.1 [5.1 – 7.0]	↓7.3 [6.2 – 8.4]	↓0.1 [-0.3 – 0.3]	↓0.1 [-0.2 – 0.4]	↓0.1 [-0.2 – 0.4]	↓0.5 [0.3 – 0.9]
<i>New colonisations</i>	6.2 [5.8 – 6.8]	↓0.1 [0.1 – 0.3]	↓0.4 [0.2 – 0.7]	↓1.3 [1.0 – 1.6]	↓1.9 [1.6 – 2.2]	0 [-0.1 – 0.2]	↑0.3 [0.1 – 0.4]	↑0.3 [0.1 – 0.4]	↑2.2 [1.9 – 2.5]
<i>New infections</i>	7.7 [6.8 – 8.6]	↓0.2 [0.1 – 0.4]	↓1.1 [0.8 – 1.5]	↓4.7 [3.8 – 5.7]	↓5.3 [4.3 – 6.3]	0 [-0.2 – 0.2]	↓0.3 [0.2 – 0.5]	↓0.3 [0.2 – 0.5]	↓2.8 [2.4 – 3.1]
ICU-onset	3.3 [2.9 – 3.7]	↓0.1 [0.1 – 0.2]	↓0.5 [0.3 – 0.7]	↓2.0 [2.3 – 3.3]	↓2.3 [1.9 – 2.8]	0 [-0.1 – 0.1]	↓0.2 [0.1 – 0.3]	↓0.2 [0.1 – 0.3]	↓1.3 [1.1 – 1.4]
No ICU-onset	4.4 [3.9 – 4.9]	↓0.1 [0 – 0.2]	↓0.6 [0.4 – 0.8]	↓2.7 [2.2 – 3.3]	↓3.0 [2.5 – 3.7]	0 [-0.1 – 0.1]	↓0.2 [0.1 – 0.3]	↓0.2 [0.1 – 0.3]	↓1.5 [1.3 – 1.7]
Total imported infections	7.5 [7.1 – 8.1]								
<i>Community-acquired</i>	7.0 [6.6 – 7.5]	0 [0 – 0.1]	↓0.7 [0.5 – 0.8]	↓2.0 [2.0 – 2.4]	↓2.8 [2.6 – 3.0]	0 [-0.1 – 0.1]	↓0.7 [0.5 – 0.8]	↓0.7 [0.5 – 0.8]	↓2.8 [2.6 – 3.0]
<i>Readmission of previously colonised/ infected case</i>	0.5 [0.5 – 0.6]	↓0.1 [0.1 – 0.1]	↓0.1 [0 – 0.1]	↓0.3 [0.3 – 0.4]	↓0.4 [0.4 – 0.5]	↓0.1 [0.1 – 0.1]	↓0.1 [0 – 0.1]	↓0.1 [0 – 0.1]	↓0.4 [0.4 – 0.4]
Total imported colonisations	20.8 [20.3 – 21.4]								
<i>Community-acquired</i>	18.6 [18.1 – 19.1]	0 [-0.2 – 0.1]	↑0.6 [0.4 – 0.8]	↑1.8 [1.6 – 2.0]	↑2.3 [2.0 – 2.5]	0 [-0.2 – 0.1]	↑0.6 [0.4 – 0.8]	↑0.6 [0.4 – 0.8]	↑2.3 [2.0 – 2.5]
<i>Readmission of previously colonised/ infected case</i>	2.2 [2.1 – 2.3]	↓0.1 [0 – 0.4]	0.1 [0 – 0.1]	↓0.2 [0.2 – 0.3]	↓0.2 [0.2 – 0.3]	0 [-0.2 – 0.1]	0 [-0.1 – 0.1]	0 [-0.1 – 0.1]	0.1 [0.1 – 0.2]
<i>Relapse/ recurrence on readmission</i>	0.1 [0.1 – 0.1]	↓0.1 [0.1 – 0.01]	0 [0 – 0]	↓0.1 [0.1 – 0.1]	↓0.1 [0.1 – 0.1]	↓0.1 [0.1 – 0.1]	0 [0 – 0]	0 [0 – 0]	0.1 [0.1 – 0.1]

CHAPTER 6

DISCUSSION

The primary objective of this thesis was to evaluate the effectiveness of *C. difficile* vaccination strategies in preventing hospital-onset CDI.

This chapter summarises the main findings of the thesis (section 6.1), the implications for the prevention and control of *C. difficile* (section 6.2), strengths and limitations of the work conducted other than those described in the preceding chapters (section 6.3), and finishes with areas of future investigation (section 6.4).

6.1 SUMMARY OF THE MAIN FINDINGS

The systematic review (research paper one)[1] presented in Chapter 2 showed that mathematical dynamic-transmission models have become an increasingly popular tool to help understand the patient-to-patient spread of nosocomial pathogens and predict the impact of prevention and control strategies (Chapter 2). Despite the global nature of the burden of HCAI, modelling studies have been primarily limited to high-income settings, with MRSA the main subject of study. Up until 2011, *C. difficile* had rarely been modelled. This was despite many countries, such as the US and the UK, prioritising *C. difficile*, infection control programmes. The model developed here is similar to models of MRSA, where there has been a shift from a hospital scenario to one where such pathogens are considered within the whole healthcare economy e.g. by including the interactions between the home, hospital and other healthcare settings such as LTCFs[1]. Both healthcare delivery and pathogen epidemiology provide an ever-changing landscape and it is vital for credibility that such models are revisited regularly and revised based on the best data available.

Research using, amongst other techniques, whole genome sequencing previously revealed that transmission from symptomatic cases only explained a minority of the CDI-acquisitions in an English hospital and its catchment area community[2–4]. These observations were supported by analysis of the national English CDI surveillance data from a few settings (research paper two[5]). A statistically significant correlation between reported CDI incidence in different weeks suggested nosocomial *C. difficile* transmission from symptomatic cases was a source of CDI in English hospitals, although the weak correlation suggests that the extent of transmission was less than had previously been thought. In addition, this analysis provide evidence, for the first time, for seasonal patterns in reported CDI incidence in England, with an observed peak in winter (when more antimicrobials are prescribed)[5]. Hence, by making a novel use of routinely collected mandatory data, this thesis has provided clinically relevant insights into the epidemiology of CDI.

A majority of previous studies quantifying the health and economic burden of CDI have done so using inappropriate methodology, and even the few studies that have used robust methods have shown a wide variation in outcome. Having adjusted for time-dependent bias and competing risks, CDI was shown to impact the predicted hospital stay of patients with moderate and severe symptoms (research paper three[6]). In addition, comparable mortality rates were seen for severe and moderate CDI patients, whereas the excess LoS was more than doubled for the former, albeit with overlapping confidence intervals. Hence, this study has provided the first severity specific estimate of the additional LoS and excess mortality due to CDI, as well as the first robust estimates of the burden of CDI in an English hospital-setting[6].

Finally, the results of an individual-based “state-of-the-art” dynamic transmission model in an English ICU (with epidemiological parameters informed by the findings of the statistical models in Chapters 3 and 4, and with data-driven patient movement between the community, LTCF and ICU) showed that in settings with in-hospital acquisition rates comparable to the national average, immunising three patient groups: LTCF residents, elective patients and patients with a history of CDI in the ICU, resulted in a 43% reduction of ICU-onset CDI. Such a strategy would require a relatively high number of vaccine doses (i.e. over a 100 doses to prevent one case), suggesting this might be an inefficient use of

infection prevention and control resources in English ICUs, however a full cost-effectiveness analysis will have to provide more conclusive insight. It was shown that CDI dynamics in the high-risk ward setting were driven by importation of colonised patients. A targeted strategy involving patients at high risk of colonisation on admission, such as LTCF residents proved more efficient. However, a critical fraction of this group would have to be identified in order for vaccination to have a population-effect on CDI-dynamics. As risk factors associated with colonisation, are likely to be multifaceted (e.g. recent hospitalisation, frequent antimicrobial use, previous ICU stay[7, 8]), this might prove difficult to translate into a practical and feasible vaccination strategy. Nevertheless, this should be an area of further investigation.

This thesis also found that the effectiveness of vaccination proved highly sensitive to the levels of ward-based patient-to-patient transmission and antimicrobial usage, with effectiveness increasing as either transmission or antimicrobial use increased. Therefore, it was concluded that vaccination might be most efficient (and perhaps cost-effective) in settings where implementation of antimicrobial stewardship prove to be a challenge.

Finally, the work presented here highlighted the critical need for improving our understanding of the role of asymptomatic carriers in the transmission-dynamics of *C. difficile*. Vaccination could successfully induce a herd-immunity effect in the ICU, i.e. reduce the ward-based *C. difficile* acquisition risk from asymptomatic and symptomatic patients. Nonetheless, if asymptomatic carriers contribute to the transmission-dynamics of *C. difficile*, and assuming that the vaccine did not provide direct-protection against asymptomatic carriage, an increase in colonisations outside the ICU was not prevented. Hence, and due to the unique set-up of the mathematical modelling framework used, this thesis provided the first insight into the potential unintended consequences of vaccination.

6.2 IMPLICATIONS FOR HEALTH POLICY AND CLINICAL PRACTICE

Existing CDI prevention and control measures, such as improved hand hygiene, isolation and environmental cleaning of hospital rooms occupied by CDI positive cases, have primarily focused on

containing the transmission from symptomatic carriers (Chapter 1). Chapter 3 suggested that transmission from this group of patients is only likely to explain a fraction of CDI incidence in English hospitals (otherwise one would expect to see far more clustering of cases in space and time). As discussed in Chapter 1, asymptomatic carriers have been suggested as potential contributors to *C. difficile* acquisition since the early 1990s [9–11]. Increased availability of advanced genetic typing methods have allowed for more detailed and reliable investigation, and suggested likewise[12], although more research is needed [13]. If asymptomatic carriers are at least in part responsible for *C. difficile* and CDI acquisition, the number of new acquisitions due to each asymptomatic case must be low to match the observations of wide genetic variability, as discussed also in Chapter 3[5]. Similarly, using less discriminatory molecular typing (i.e. restriction enzyme analysis (REA)[14] and arbitrarily primed PCR[15]), it was shown that in non-epidemic settings, *C. difficile* isolates revealed wide genotypic diversity, with little evidence for direct or indirect cross-transmission between symptomatic[15], but also between asymptomatic and symptomatic patients[14]. Chapter 5 showed, when simulating CDI transmission-dynamics using a model that was fitted to ICU-acquisition rates representative of the English national average, a large fraction of the healthcare-onset CDI are likely to be imported from outside the ICU. There are wider questions now being asked regarding the possible sources of *C. difficile* due to its recovery from diverse environmental sites such as meat and vegetables consumed by humans[16–19], as well as water and soil[20]. Moreover, farm and domestic animals have been documented to carry *C. difficile* with overlapping ribotypes to humans[21–23]. However, evidence on the transmission risk from these alternative sources has been inconclusive to date [24].

These existing uncertainties on human acquisition sources of *C. difficile* emphasise the importance of efforts other than barrier precautions such as isolation and deep cleaning, i.e. those that focus on decreasing patients' susceptibility to *C. difficile* (producing CDI or colonisation). CDI vaccination could be an example of such strategy (although the current toxoid vaccines under development are not thought to prevent colonisation), as well as antimicrobial stewardship. Where adequate surveillance is in place, it is evident that in some countries, such as the US, CDI incidence remains high[25, 26]. According to a recent population-based surveillance study about half a million people annually continue to suffer from CDI, including 29,000 deaths [25]. In the US between 2011 to 2013, the *C. difficile* strain BI/NAP1/027

continued to be reported most commonly[27]. In Chapter 5, it was shown that under these conditions, a CDI vaccine could have a considerable population-effect, and the use of a strategy of vaccination of a large group of patients, e.g. those due for elective surgery, increased significantly in efficiency compared to when assuming lower CDI acquisition rates. However, widespread overuse and inappropriate antimicrobial prescribing has been documented in many countries including the US[28, 29]. Although not the primary aim of this thesis, Chapter 5 revealed that the reduction of 'high risk' antimicrobials could help reduce both healthcare onset-CDI in imported colonised patients, as well as help reduce healthcare acquisition. In previous studies, hospital-based antimicrobial stewardship programmes are associated with reductions in CDI rates of up to 60%[30, 31]. In England, the dramatic reductions observed have been largely attributed to the significant decline in cephalosporin and quinolone use (Chapter 1). However, the exact impact of this measure is difficult to quantify with certainty considering the parallel timing of a bundle of government-led measures (i.e. mandatory-surveillance, increased compliance with isolation and hand hygiene, target-setting). Future mathematical modelling could help quantify the relative effectiveness of individual- and bundled implementation of existing (and new) interventions, and provide further insight in how and where antimicrobial stewardship could be valuable as well as feasible.

There will be situations where reduction of consumption of antimicrobials associated with CDI proves unsuccessful, or impossible. Antimicrobial prophylaxis (including the use of cephalosporins (e.g. cefazolin) and fluoroquinolones) is recommended for patients at high risk for surgical site infections when undergoing certain invasive procedures such as colectomy, hip replacement and cardiac operations[32, 33], and has been associated with an increased risk for CDI[32, 34]. Moreover, patients with chronic illness such as renal failure[35, 36] may be vulnerable to primary and recurrent CDI due to their frequent exposure to antimicrobials, and hospitalisation, as well as presence of other risk factors associated with the infection (e.g. immunosuppression and gastro-acid suppressants). Further clinical trials are needed to assess how the vaccine performs among patients with such chronic co-morbidities. Moreover, for any future vaccine strategy design, the time required to mount an adaptive immune response post active immunisation requires careful attention. The latest clinical trial data suggest there is a need for three doses to provoke an antibody response in patients over 65 years old[37], diminishing the vaccine's suitability for

strategies requiring a rapid immune response. Future modelling research could help identify whether vaccination of these and potential other cohorts of vulnerable patients proves feasible (see section 6.4).

Despite the significant reduction in cephalosporin and fluoroquinolone use, overall frequency of antimicrobial prescribing remained stable in England, with increases in piperacillin/tazobactam, co-amoxiclav and carbapenem use[38–40]. An emergence of extended spectrum beta-lactamase (ESBL)-producing *Enterobacteriaceae* has been noted, with resistances now observed nationally and globally against the next-line antimicrobials of choice, the carbapenems[41, 42]. This calls for further efforts including the monitoring of local and national prescribing and consumption data to aid reduction in the inappropriate and overuse of antimicrobials[28, 29].

In Chapter 5, through extensive data analysis and model parameterisation, it was shown that CDI-onset in the ICU is unlikely to be primarily driven by ward-based acquisitions, but instead importations. Admission screening might aid in early recognition of cases “imported” into the ICU. Recent modelling studies concluded that screening patients on admission for asymptomatic carriage could reduce new acquisitions by 40-50% and hospital-onset CDI by 10-25%[43], and might be cost-effective[44]. Both studies incorporated strong assumptions on the transmissibility of asymptomatic carriers relative to symptomatic patients (i.e. equal). As shown in Chapter 5, the presumed infectiousness of the latter group has a considerable impact on predicted intervention effectiveness. This calls for further investigation on the relative role of alternative transmission routes, before CDI prevention and control policies are expanded to include such measures (see section 6.4).

6.3 STRENGTHS AND LIMITATIONS

In the preceding chapters, the strengths and limitations of the different sub-studies have been discussed. In the section below, more general strengths and limitations of the thesis are acknowledged with regards to its overall scope, the data used and the generalisability of the findings.

6.3.1 STRENGTHS

This thesis provided the first detailed account of the existing dynamic modelling studies in the field of hospital epidemiology (Chapter 2). This should provide an improved understanding of the quality of HCAI transmission models, as well as directions for further modelling work to address existing and emerging HCAI, such as multi-drug resistant Gram-negative bacteria.

Secondly, by making use of routinely collected mandatory data, this thesis investigated, for the first time, the contribution of in-hospital CDI transmission on a national level (Chapter 3). As has recently been shown for *E. coli* bloodstream infections[45], the approach can be easily implemented in settings outside England, as well as for alternative infectious agents.

Thirdly, this thesis provided the first and only robust estimates of the excess LoS due to CDI in a European-setting (Chapter 4). Also, this thesis assessed the interaction between CDI disease severity and excess LoS and mortality, which had not been previously quantified. As excess bed-days are the main drivers of associated costs[46], and affect the transmission-dynamics of the bacterium, the work presented here has provided accurate estimates to help inform future (cost-)effectiveness analysis of vaccination, as well as other therapies (e.g. faecal transplantation [47]), and new antimicrobial therapies [48] in the pipeline.

Finally, Chapter 5 presented the first dynamic-transmission model-based evaluation of the projected effectiveness of different vaccination strategies on CDI incidence in a high CDI-risk hospital setting. A major strength of the approach employed was the incorporation of data-driven patient movements between the hospital, community and LTCF to simulate the dynamics of *C. difficile* transmission. This enabled detailed examination of the complex balance between importation and acquisition of CDI and its interaction with intervention effectiveness. Moreover, the extensive analysis of numerous data sources to inform (and the explicit inclusion of associated uncertainties) sets an example for future modelling work. The model structure can be easily adapted to alternative settings, and extended, e.g. to include patient movement patterns in the hospital, provided appropriate data is available.

6.3.2 LIMITATIONS

The work presented in this thesis had its focus limited to nosocomial CDI, and within the hospital, to the ICU-setting. Hence, the work presented here might have missed potential uses of vaccination outside this setting.

The model attempted to incorporate *C. difficile* dynamics between hospital and community settings by including readmission dynamics from LTCFs and the general population. However, fixed importation rates from community settings were used. Thus, the effectiveness of vaccination policies were probably underestimated in the model, as one would expect a lower importation rate from these settings after vaccination is adopted. Moreover, the model could not discriminate between the locations of CDI-onset, i.e. elsewhere in hospital or in the community. Ideally, the model would have included patient movements between the ICU and other hospital wards, as well as include a dynamic account of the transmission outside the ICU (i.e. other hospital wards as well as in the community). This would have allowed for the effectiveness of vaccination in the prevention of onward transmission within the hospital as a whole as well as community-settings.

For example, in LTCFs where *C. difficile* carriage can be high [49], and implementation of traditional prevention and control measures such as environmental decontamination and isolation are more challenging, vaccination could help reduce community-onset of diarrhoea. The rationale for the narrow scope taken was two-fold. First of all, individual-based models are computationally demanding. This combined with the high number of model permutations deemed necessary (due to the uncertainty in the epidemiology of CDI, patient characteristics, as well as the heterogeneity between ICU-settings) resulted in a computationally expensive analysis. Modelling a wider hospital population would have increased the computational time significantly, let alone inclusion of community and LTCF dynamics. Secondly, extensive data analysis was performed to ensure representation of an ICU in England as closely as possible. Limited data is available on *C. difficile* incidence and transmission in community-settings. Therefore, a holistic dynamic hospital-community model would have been highly theoretical and potentially damaged the validity of what has been achieved.

Although the model included heterogeneity in risk factors associated with CDI between the general community and LTCF populations, no further details differences in term of risk profiles among the ICU patients were included. For example, elective patients were assumed to be at equal risk of exposure to antimicrobial use as the rest of the ICU population. As mentioned earlier, for certain surgical procedures, antimicrobial prophylaxis is a common prescription. Including more heterogeneity in risk would allow for further investigation of potential vaccine populations. However, this would be highly data demanding.

Finally, this thesis did not include a cost-effectiveness analysis, therefore could not provide conclusive results on whether vaccination would be a cost-effective use of infection prevention and control resources.

6.4 AREAS OF FURTHER RESEARCH

An additional extension to the presented model would be enhanced incorporation of heterogeneity in patients based on risk factors associated with the infection such as reason for admission (including type of elective surgery), age, and co-morbidity. This may aid in optimising the identification of target groups most likely to benefit from vaccination. Moreover, an evaluation of the cost-effectiveness of the investigated vaccination strategies was beyond the scope of this thesis, but would be an obvious future step. As this model did not investigate the full scope of CDI vaccination (such as prevention of community onset and transmission), a future cost-effectiveness approach could extend the model presented here by including patient movement patterns between hospital wards as well as dynamic-transmission between healthcare- and community-settings. This would require further understanding of *C. difficile* transmission dynamics in both hospital- and community-settings. Studies involving the screening of patients on hospital admission for *C. difficile* colonisation, combined with whole genome sequencing of isolates from asymptomatic and symptomatic cases, could provide more conclusive insight into the contribution of asymptomatic carriers in the transmission-dynamics of the bacterium[50]. However, such studies are costly (although are becoming more affordable) and may be, at least for now, unfeasible. As

shown in Chapter 2, using formal fitting techniques, mathematical models have proven capable of estimation of the various sources of acquisition routes of healthcare-associated bacteria, provided the colonisation status of all patients on admission is known [51, 52]. Therefore, a suggested future area of research could involve the application of these models using on-admission screening data, e.g.[53]. In addition, further understanding is needed on the *C. difficile* dynamics in community settings. Useful data could be drawn from household studies, involving the screening of household members of patients found positive for symptomatic or asymptomatic *C. difficile*, as has recently been done to investigate the spread of Gram-negative bacteria[54]. These could help inform meta-population models of *C. difficile* that could quantify the patient-to-patient spread in the community. Estimated (transmission) parameters from these structurally more parsimonious models (as opposed to the model presented here) could be used to inform the aforementioned holistic model.

Also, an improved general understanding of the health needs of patients in LTCF is required. In Europe, antimicrobial use and healthcare-associated infection surveillance in these settings has been limited to ad hoc point prevalence surveys [55, 56]. The US has recently implemented a comprehensive population-based surveillance for CDI, which incorporates a separate definition for LTCF onset cases [25]. To identify the need for prevention and control measures in these settings, national surveillance systems should be expanded to surveillance of CDI outside hospital-settings, as has been initiated in the US.

Antimicrobial stewardship can help prevent onset among asymptotically imported cases as well as successfully reduce onward transmission. Similar conclusions have been drawn based on retrospective observations (e.g. the decline in *C. difficile* rates observed in England), and statistical analyses[30, 31]. However, infection prevention and control intervention strategies are commonly implemented simultaneously, making the quantification of the relative effectiveness of the implemented strategies challenging. Future mathematical modelling could help quantify the relative effectiveness of individual- and bundled implementation of existing (and new) interventions, and provide further insight into how and where antimicrobial stewardship could be valuable as well as feasible.

Finally, further research is needed to understand differences between studies in the effect of CDI on patient LoS. In Chapter 4, it was shown that neither difference in age and co-morbidity, nor in the severity of the CDI infection explained why in a Canadian study, using robust methods, CDI was found to increase patients' stay[57] but not in an Australian study[58]. This thesis concurs with the Canadian study, finding an excess LoS of approximately one week due to CDI. All three studies concern single hospital-settings, with relatively small datasets, resulting in more uncertain estimates. A recent study, conducted in the US, used retrospective data from 120 acute care facilities and found, similarly to this thesis, that severity of CDI had an increased impact on LoS[59]. The data comprised a detailed account of patient characteristics (age, sex, ICU stay on admission) and facility characteristics (teaching hospital or not, bed size, rural location or not, census region). Interestingly, when fitting a multi-state model to sub strata of data (as was done in this thesis), differences in the impact of CDI were observed within the US census regions, similarly to the differences described above (i.e. less than one day increase up to ~5 day increase in LoS across regions). As accounting for multiple co-variates in a multi-state model remains a computationally challenging task to date, these results did not show the interaction between the above listed factors. Using similarly rich data to fit e.g. a Cox proportional hazards model as done in this thesis could identify whether these patient and/or facility characteristic could explain these regional differences. If not, this might hint at other factors, such as hospital practice on e.g. infection prevention and control, which should be area of further investigation.

References

1. van Kleef E, Robotham J V, Jit M, Deeny SR, Edmunds WJ: **Modelling the transmission of healthcare associated infections: a systematic review.** *BMC Infect Dis* 2013, **13**:294.
2. Eyre DW, Cule ML, Wilson DJ, Griffiths D, Vaughan A, O'Connor L, Ip CLC, Golubchik T, Batty EM, Finney JM, Wyllie DH, Didelot X, Piazza P, Bowden R, Dingle KE, Harding RM, Crook DW, Wilcox MH, Peto TE a., Walker a. S: **Diverse Sources of C. difficile Infection Identified on Whole-Genome Sequencing.** *N Engl J Med* 2013, **369**:1195–1205.
3. Walker a S, Eyre DW, Wyllie DH, Dingle KE, Harding RM, O'Connor L, Griffiths D, Vaughan A, Finney J, Wilcox MH, Crook DW, Peto TE a: **Characterisation of Clostridium difficile hospital ward-based transmission using extensive epidemiological data and molecular typing.** *PLoS Med* 2012, **9**:e1001172.
4. Didelot X, Eyre D, Cule M, Ip C, Ansari A, Griffiths D, Vaughan A, O'Connor L, Golubchik T, Batty E, Piazza P, Wilson D, Bowden R, Donnelly P, Dingle K, Wilcox M, Walker S, Crook D, Peto T, Harding R: **Microevolutionary analysis of Clostridium difficile genomes to investigate transmission.** *Genome Biol* 2012, **13**:R118.
5. van Kleef E, Gasparrini A, Guy R, Cookson B, Hope R, Jit M, Robotham J V, Deeny SR, Edmunds WJ: **Nosocomial transmission of C. difficile in English hospitals from patients with symptomatic infection.** *PLoS One* 2014, **9**:e99860.
6. van Kleef E, Green N, Goldenberg SD, Robotham JV, Cookson B, Jit M, Edmunds WJ, Deeny SR: **Excess length of stay and mortality due to Clostridium difficile infection: a multi-state modelling approach.** *J Hosp Infect* 2014, **88**:213–217.
7. Hensgens MPM, Goorhuis A, van Kinschot CMJ, Crobach MJT, Harmanus C, Kuijper EJ: **Clostridium difficile infection in an endemic setting in the Netherlands.** *Eur J Clin Microbiol Infect Dis* 2011, **30**:587–93.
8. Vesteynsdottir I, Gudlaugsdottir S, Einarsdottir R, Kalaitzakis E, Sigurdardottir O, Bjornsson ES: **Risk factors for clostridium difficile toxin-positive diarrhea: A population-based prospective case-control study.** *Eur J Clin Microbiol Infect Dis* 2012, **31**:2601–2610.
9. Clabots CR, Johnson S, Olson MM, Peterson LR, Gerding DN: **Acquisition of Clostridium difficile by hospitalized patients: evidence for colonized new admissions as a source of infection.** *J Infect Dis* 1992, **166**:561–7.
10. Guerrero DM, Becker JC, Eckstein EC, Kundrapu S, Deshpande a, Sethi a K, Donskey CJ: **Asymptomatic carriage of toxigenic Clostridium difficile by hospitalized patients.** *J Hosp Infect* 2013:2–5.
11. Riggs MM, Sethi AK, Zabarsky TF, Eckstein EC, Jump RLP, Donskey CJ: **Asymptomatic Carriers Are a Potential Source for Transmission of Epidemic and Nonepidemic Clostridium difficile Strains among Long-Term Care Facility Residents.** *Clin Infect Dis* 2007, **45**:992–998.
12. Curry SR, Muto CA, Schlackman JL, Pasculle AW, Shutt KA, Marsh JW, Harrison LH: **Use of MLVA Genotyping to Determine the Role of Asymptomatic Carriers in C. difficile Transmission.** *Clin Infect Dis* 2013.
13. Eyre DW, Griffiths D, Vaughan A, Golubchik T, Acharya M, O'Connor L, Crook DW, Walker a S, Peto TE a: **Asymptomatic Clostridium difficile colonisation and onward transmission.** *PLoS One*

2013, **8**:e78445.

14. Samore MH, Bettin KM, Degirolami PC, Clabots CR, Dale N, Karchmer AW, Samore MH, Bettin KM, Degirolami PC, Clabots CR, Gerding DN, Karchmer AW: **Wide Diversity of Clostridium difficile Types at a Tertiary Referral Hospital.** *J Infect Dis* 1994, **170**:615–621.

15. Cohen SH, Tang YJ, Muenzer J, Gumerlock PH, Silva J: **Isolation of various genotypes of Clostridium difficile from patients and the environment in an oncology ward.** *Clin Infect Dis* 1997, **24**:889–93.

16. Songer JG: **The emergence of Clostridium difficile as a pathogen of food animals.** *Anim Health Res Rev* 2004, **5**:321–326.

17. Songer JG, Trinh HT, Killgore GE, Thompson AD, McDonald LC, Limbago BM: **Clostridium difficile in retail meat products, USA, 2007.** *Emerg Infect Dis* 2009, **15**:819–821.

18. Rodriguez-Palacios A, Staempfli HR, Duffield T, Weese JS: **Clostridium difficile in retail ground meat, Canada.** *Emerg Infect Dis* 2007, **13**:485–487.

19. Weese JS, Avery BP, Rousseau J, Reid-Smith RJ: **Detection and enumeration of Clostridium difficile spores in retail beef and pork.** *Appl Environ Microbiol* 2009, **75**:5009–5011.

20. al Saif N, Brazier JS: **The distribution of Clostridium difficile in the environment of South Wales.** *J Med Microbiol* 1996, **45**:133–7.

21. Hensgens MPM, Keessen EC, Squire MM, Riley T V, Koene MGJ, de Boer E, Lipman LJ a, Kuijper EJ: **Clostridium difficile infection in the community: a zoonotic disease?** *Clin Microbiol Infect* 2012:1–11.

22. Bakker D, Corver J, Harmanus C, Goorhuis a, Keessen EC, Fawley WN, Wilcox MH, Kuijper EJ: **Relatedness of human and animal Clostridium difficile PCR ribotype 078 isolates determined on the basis of multilocus variable-number tandem-repeat analysis and tetracycline resistance.** *J Clin Microbiol* 2010, **48**:3744–9.

23. Knetsch CW, Connor TR, Mutreja A, van Dorp SM, Sanders IM, Browne HP, Harris D, Lipman L, Keessen EC, Corver J, Kuijper EJ, Lawley TD: **Whole genome sequencing reveals potential spread of Clostridium difficile between humans and farm animals in the Netherlands, 2002 to 2011.** *Euro Surveill* 2014, **19**:20954.

24. Gould LH, Limbago B: **Clostridium difficile in food and domestic animals: a new foodborne pathogen?** *Clin Infect Dis* 2010, **51**:577–82.

25. Lessa F, Yi Mu M, Bamberg W, Beldavs Z, Dumyati G, Dunn J, Farley M, Holzbauer S, Meek J, Phipps EC, Wilson LE, Winston LG, Cohen JA, Limbago BM, Ph D, Fridkin SK, Gerding DN, McDonald LC: **Burden of Clostridium difficile Infection in the United States.** *N Engl J Med* 2015, **372**:825–34.

26. Lessa FC, Gould C V, McDonald LC: **Current status of Clostridium difficile infection epidemiology.** *Clin Infect Dis* 2012, **55 Suppl 2**(Suppl 2):S65–70.

27. Tickler I a., Goering R V., Whitmore JD, Lynn ANW, Persing DH, Tenover FC: **Strain types and antimicrobial resistance patterns of Clostridium difficile isolates from the United States, 2011 to 2013.** *Antimicrob Agents Chemother* 2014, **58**:4214–4218.

28. Chitnis AS, Holzbauer SM, Belflower RM, Winston LG, Bamberg WM, Lyons C, Farley MM,

- Dumyati GK, Wilson LE, Beldavs ZG, Dunn JR, Gould LH, Maccannell DR, Gerding DN, McDonald LC, Lessa FC: **Epidemiology of Community-Associated Clostridium difficile Infection, 2009 Through 2011.** *JAMA Intern Med* 2013, **173**:1359–67.
29. Shapiro DJ, Hicks L a., Pavia AT, Hersh AL: **Antibiotic prescribing for adults in ambulatory care in the USA, 2007-09.** *J Antimicrob Chemother* 2014, **69**:234–240.
30. Talpaert MJ, Rao GG, Cooper BS, Wade P: **Impact of guidelines and enhanced antibiotic stewardship on reducing broad-spectrum antibiotic usage and its effect on incidence of Clostridium difficile infection.** *J Antimicrob Chemother* 2011, **66**:2168–2174.
31. Sarma JB, Marshall B, Cleeve V, Tate D, Oswald T, Woolfrey S: **Effects of fluoroquinolone restriction (from 2007 to 2012) on Clostridium difficile infections: interrupted time-series analysis.** *J Hosp Infect* 2015, **91**:74–80.
32. the Scottish Intercollegiate Guidelines Network (SIGN): *Antibiotic Prophylaxis in Surgery A National Clinical Guideline.* 2014(April).
33. Bratzler DW, Dellinger EP, Olsen KM, Perl TM, Auwaerter PG, Bolon MK, Fish DN, Napolitano LM, Sawyer RG, Slain D, Steinberg JP, Weinstein R a.: **Clinical practice guidelines for antimicrobial prophylaxis in surgery.** *Am J Heal Pharm* 2013, **70**:195–283.
34. Southern WN, Rahmani R, Aroniadis O, Thanjan A, Ibrahim C, Brandt LJ: **Post-Surgical Clostridium difficile-Associated Diarrhea William.** *Surgery* 2010, **148**:24–30.
35. Thongprayoon C, Cheungpasitporn W, Phatharacharukul P, Edmonds PJ, Kaewpoowat Q, Mahaparn P, Bruminhent J, Erickson SB: **Chronic kidney disease and end-stage renal disease are risk factors for poor outcomes of Clostridium difficile infection: a systematic review and meta-analysis.** *Int J Clin Pract* 2015:n/a–n/a.
36. Keddis MT, Khanna S, Noheria A, Baddour LM, Pardi DS, Qian Q: **Clostridium difficile infection in patients with chronic kidney disease.** *Mayo Clin Proc* 2012, **87**:1046–1053.
37. Foglia G, Shah S, Luxemburger C, Freda PJ: **Clostridium difficile : Development of a novel candidate vaccine.** *Vaccine* 2012, **30**:4307–4309.
38. Public Health England: *English Surveillance Programme for Antimicrobial Utilisation and Resistance (ESPAUR) Report 2014 About Public Health England.* London; 2014.
39. Ashiru-oredope D, Sharland M, Charani E, McNulty C, Cooke J: **Improving the quality of antibiotic prescribing in the nhs by developing a new antimicrobial stewardship programme: Start smart-then focus.** *J Antimicrob Chemother* 2012, **67**:51–63.
40. Public Health England (former Health Protection Agency): *English National Point Prevalence Survey on Healthcare-Associated Infections and Antimicrobial Use, 2011 - Preliminary Data.* London; 2012.
41. Souli M, Galani I, Giamarellou H: **Emergence of extensively drug-resistant and pandrug-resistant Gram-negative bacilli in Europe.** *Eurosurveillance* 2008, **13**:1–11.
42. ECDC: *Surveillance Report - Antimicrobial Resistance Surveillance in Europe.* Stockholm; 2014.
43. Lanzas C, Dubberke ER: **Effectiveness of Screening Hospital Admissions to Detect Asymptomatic Carriers of Clostridium difficile: A Modeling Evaluation.** *Infect Control Hosp Epidemiol* 2014, **35**:1043–50.

44. Bartsch SM, Curry SR, Harrison LH, Lee BY: **The potential economic value of screening hospital admissions for *Clostridium difficile***. *Eur J Clin Microbiol Infect Dis* 2012.
45. Deeny SR, van Kleef E, Bou-Antoun S, Hope RJ, Robotham J V: **Seasonal changes in the incidence of *Escherichia coli* bloodstream infection: variation with region and place of onset**. *Clin Microbiol Infect* 2015:1–6.
46. Graves N, Harbarth S, Beyersmann J, Barnett A, Halton K, Cooper B: **Estimating the cost of health care-associated infections: Mind your p's and q's**. *Clin Infect Dis* 2010, **50**:1017–1021.
47. van Nood E, Vriese A, Nieuwdorp M, Fuentes S, Zoetendal EG, de Vos WM, Visser CE, Kuijper EJ, Bartelsman JFWM, Tijssen JGP, Speelman P, Dijkgraaf MGW, Keller JJ: **Duodenal infusion of donor feces for recurrent *Clostridium difficile***. *N Engl J Med* 2013, **368**:407–15.
48. Jarrad AM, Karoli T, Blaskovich MAT, Lyras D, Cooper MA: ***Clostridium difficile* Drug Pipeline : Challenges in Discovery and Development of New Agents**. *Journald Med Chem* 2015.
49. Ziakas PD, Zacharioudakis IM, Zervou FN, Grigoras C, Pliakos EE, Mylonakis E: **Asymptomatic Carriers of Toxigenic *C. difficile* in Long-Term Care Facilities: A Meta-Analysis of Prevalence and Risk Factors**. *PLoS One* 2015, **10**:e0117195.
50. Knetsch CW, Lawley TD, Hensgens MP, Corver J, Wilcox MW, Ku EJ: **Current application and future perspectives of molecular typing methods to study *Clostridium difficile* infections**. 2013:1–11.
51. Pelupessy I, Bonten MJM, Diekmann O: **How to assess the relative importance of different colonization routes of pathogens within hospital settings**. *Proc Natl Acad Sci U S A* 2002, **99**:5601–5605.
52. Bootsma MCJ, Bonten MJM, Nijssen S, Fluit a C, Diekmann O: **An algorithm to estimate the importance of bacterial acquisition routes in hospital settings**. *Am J Epidemiol* 2007, **166**:841–51.
53. Tschudin-Sutter S, Carroll KC, Tamma PD, Sudekum ML, Frei R, Widmer AF, Ellis BC, Bartlett J, Perl TM: **Impact of Toxigenic *Clostridium difficile* Colonization on the Risk of Subsequent *C. difficile* Infection in Intensive Care Unit Patients**. *Infect Control Hosp Epidemiol* 2015:1–6.
54. **Impact of specific antibiotic therapies on the prevalence of human host resistant bacteria** [<http://www.saturn-project.eu/main-findings-results/>]
55. European Centre for Disease Prevention and Control: *Point Prevalence Survey of Healthcare-Associated Infections and Antimicrobial Use in European Long-Term Care Facilities - April - May 2013*. Stockholm: European Centre for Disease Prevention and Control; 2013(May).
56. Moro ML, Jans B, Cookson B, Fabry J: **The burden of healthcare-associated infections in European long-term care facilities**. *Infect Control Hosp Epidemiol* 2010, **31 Suppl 1**(November 2010):S59–S62.
57. Forster AJ, Taljaard M, Oake N, Wilson KW, Roth V, van Walraven C: **The effect of hospital-acquired infection with *Clostridium difficile* on length of stay in hospital**. *CMAJ* 2012, **184**:17–8.
58. Mitchell BG, Gardner A, Barnett AG, Hiller JE, Graves N: **The prolongation of length of stay because of *Clostridium difficile* infection**. *Am J Infect Control* 2013:1–4.
59. Stevens VW, Khader K, Nelson RE, Jones M, Rubin M a, Brown K a, Evans ME, Greene T, Slade E,

Samore MH: **Excess Length of Stay Attributable to Clostridium difficile Infection (CDI) in the Acute Care Setting: A Multistate Model.** *Infect Control Hosp Epidemiol* 2015(Cdi):1-7.

APPENDIX A: OVERVIEW OF ALL CDI VACCINE CLINICAL TRIALS

Vaccine	Sponsor	Start date	End date	Phase	Trial number	Study group	Country	Intervention	Primary endpoint(s)	Ref
ACAM-CDIFF™	Sanofi Pasteur	Jul 2005	Mar 2006	I	NCT00127803	Adults 18 to 55	US	Placebo vs 3 dose values of toxoid vaccine respectively (i.e. 2µg, 10µg, 50µg). Doses provided on day 0, 28 and 56	1) Solicited injection site erythema and tenderness post-vaccination; 2) Treatment-emergent adverse events	[87,290]
		Nov 2005	Feb 2006	I	NCT00214461	Adults >= 65	US	Placebo vs 3 dose values of toxoid vaccine respectively (i.e. 2µg, 10µg, 50µg). Doses provided on day 0, 28 and 56	1) Treatment-emergent adverse events	[87,290]
		Mar 2006	Jun 2006	I	NCT00772954	Adults 18 to 55	?	Placebo vs 2 dose values of toxoid vaccine respectively (i.e. 50µg, 100µg). Doses provided on day 0, 28 and 56	1) Treatment-emergent adverse events	[87,290]
		Feb 2009	Jun 2012	II	NCT00772343	Adults 18 to 85	US, UK	Placebo vs low dose with adjuvant vs high dose with adjuvant vs high dose without adjuvant. Doses provided on day 0, 7 and 28	1) Recurrence of CDI ~13w post-vaccination	

		Oct 2010	Mar 2013	II	NCT0123095 7	Adults 40 to 75	US	Placebo vs low dose with adjuvant vs low dose without adjuvant vs high dose with adjuvant vs high dose without adjuvant. Provided on day 0, 7 and 30. Moreover, high dose with and without adjuvant are also provided on day 0, 30 and 180 in two separate groups	1) Safety profile in each study group; 2) immune response to toxoid A and B
		Jul 2013	Jun 2014	I/II	NCT0189683 0	Adults 40 to 75	Japan	Placebo vs toxoid vaccine	1) Safety profile in each study group; 2) immune response to toxoid A and B
		Jul 2013	Dec 2017	III	NCT0188791 2	Adults >= 50	Australia, Brazil, Canada, Chile, Colombia, Finland, France, Germany, Republic of Korea, Mexico, Peru, Puerto Rico, Singapore, Sweden, Taiwan, UK, US	Placebo vs toxoid vaccine	1) Efficacy of vaccine in preventing CDI onset after at least 1 injection
IC84	Valneva (was Intercell)	Dec 2010	Apr 2013	I	NCT0129638 6	Adults >= 65	Austria, Hungary	2 dose values of IC84 (75µg and 200µg) with and without alum (4 groups in total). Provided on day 0, 7, 28 and 56	1) Treatment-emergent adverse events
VLA84	Valneva	Dec 2014	Oct 2015	II	NCT0231647 0	Adults >= 50	Germany, US	Placebo vs 3 dose values of VLA84. Provided on day 0, 7 and 28	1) Seroconversion rate on Day 56; 2) 1) Seroconversion rate for IgG against toxin A

									and B on Day 56	
Adjuvanted vaccine	Pfizer	Jan 2014	Jul 2015	I	NCT02052726	Adults 50 to 85	US, Canada	Placebo vs vaccine with adjuvant provided at month 0, 1 and 3 vs vaccine with adjuvant on day 1, 8 and 30	1) Proportion of subjects reporting local reactions and their severity; 2) Proportion of subjects reporting systemic events and their severity	
		Jul 2014	Apr 2016	II	NCT02117570	Adults 55 to 85	US, Canada	Placebo vs 2 dose values of vaccine (low and high). Provided on day 1, 8 and 30	1) Neutralizing antibody levels at Day 37; 2) local reactions and their severity; 3) Systemic reactions and their severity; 4) Treatment-emergent adverse events	
-	GSK	Feb 2013	Jul 2015	-	NCT01716533	Adults >= 18	US, Canada	CDI recurrence group vs not recurrence group. Blood sampling done at day 0, 14, at recurrence (if applicable) and end of follow up. Moreover, stool sampling at day 0, 14 and at recurrence (if applicable)	C. difficile immune response as measured in blood samples at day 14	